



US00D747311S

(12) **United States Design Patent**
Seoc

(10) **Patent No.:** **US D747,311 S**
(45) **Date of Patent:** **** Jan. 12, 2016**

(54) **ALL-IN-ONE COMPUTER**

(56) **References Cited**

(71) Applicant: **SAMSUNG ELECTRONICS CO., LTD.**, Suwon-si, Gyeonggi-do (KR)

U.S. PATENT DOCUMENTS

(72) Inventor: **Ho-Young Seoc**, Yongin-si (KR)

1,820,841	A *	8/1931	Soref	248/463
3,990,670	A *	11/1976	Frechtman	248/470
5,927,676	A *	7/1999	Lefton	248/472
6,651,943	B2 *	11/2003	Cho et al.	248/122.1
D494,165	S *	8/2004	Yokota	D14/341
7,167,358	B2 *	1/2007	Iwasaki et al.	361/679.21
D543,979	S *	6/2007	Lee	D14/341
7,490,809	B2 *	2/2009	Liang et al.	248/676
D627,779	S *	11/2010	Liao	D14/341
7,937,810	B2 *	5/2011	Hu	16/241
D656,137	S *	3/2012	Chung et al.	D14/341
8,201,687	B2 *	6/2012	Zeliff et al.	206/320
D678,877	S *	3/2013	Groene et al.	D14/341
D695,735	S *	12/2013	Kitchen et al.	D14/341
D699,231	S *	2/2014	Kim et al.	D14/239
8,888,063	B2 *	11/2014	Mack et al.	248/454
8,922,995	B2 *	12/2014	Su	361/679.59
8,934,237	B2 *	1/2015	Cheng	361/679.55
2006/0289719	A1 *	12/2006	Liang et al.	248/676
2010/0012812	A1 *	1/2010	Hu	248/454

(73) Assignee: **SAMSUNG ELECTRONICS CO., LTD.** (KR)

(**) Term: **14 Years**

(21) Appl. No.: **29/469,926**

(22) Filed: **Oct. 16, 2013**

(30) **Foreign Application Priority Data**

Apr. 16, 2013 (KR) 30-2013-0019817

(51) **LOC (10) Cl.** **14-02**

(52) **U.S. Cl.**
USPC **D14/341**

(58) **Field of Classification Search**
USPC D14/341-347, 137, 138 R, 138 AA, D14/138 AB, 138 C, 138 G, 496, 203.1, D14/203.3, 203.4, 203.7, 129, 130, 147, D14/248, 250, 374, 385, 388, 389, 315-318, D14/439, 126, 336, 339, 340; D10/104.1; D21/329; 455/556.1, 556.2, 566, 455/575.1, 90.3; 379/433.04, 433.01, 379/433.06; 345/173, 901, 905; 361/679.26, 679.27, 679.3, 679.55, 361/679.56, 680-686; D6/308, 310; 348/373, 376; 248/917-924
CPC A63H 33/3016; G06F 1/1613; H04M 1/0202; H04M 1/0279; H04M 1/0281; H04M 1/0283

See application file for complete search history.

* cited by examiner

Primary Examiner — Barbara Fox

Assistant Examiner — Dana K Weiland

(74) *Attorney, Agent, or Firm* — Cantor Colburn LLP

(57) **CLAIM**

The ornamental design for an all-in-one computer, as shown and described.

DESCRIPTION

FIG. 1 is a top rear perspective view of an all-in-one computer showing my new design;
FIG. 2 is a front view thereof;
FIG. 3 is a rear view thereof;
FIG. 4 is a side view thereof;
FIG. 5 is another side view thereof;
FIG. 6 is a top view thereof;
FIG. 7 is a bottom view thereof; and,
FIG. 8 is another top rear perspective view with the stand in an open position.
The broken lines represent portions of the all-in-one computer that form no part of the claimed design.

1 Claim, 5 Drawing Sheets

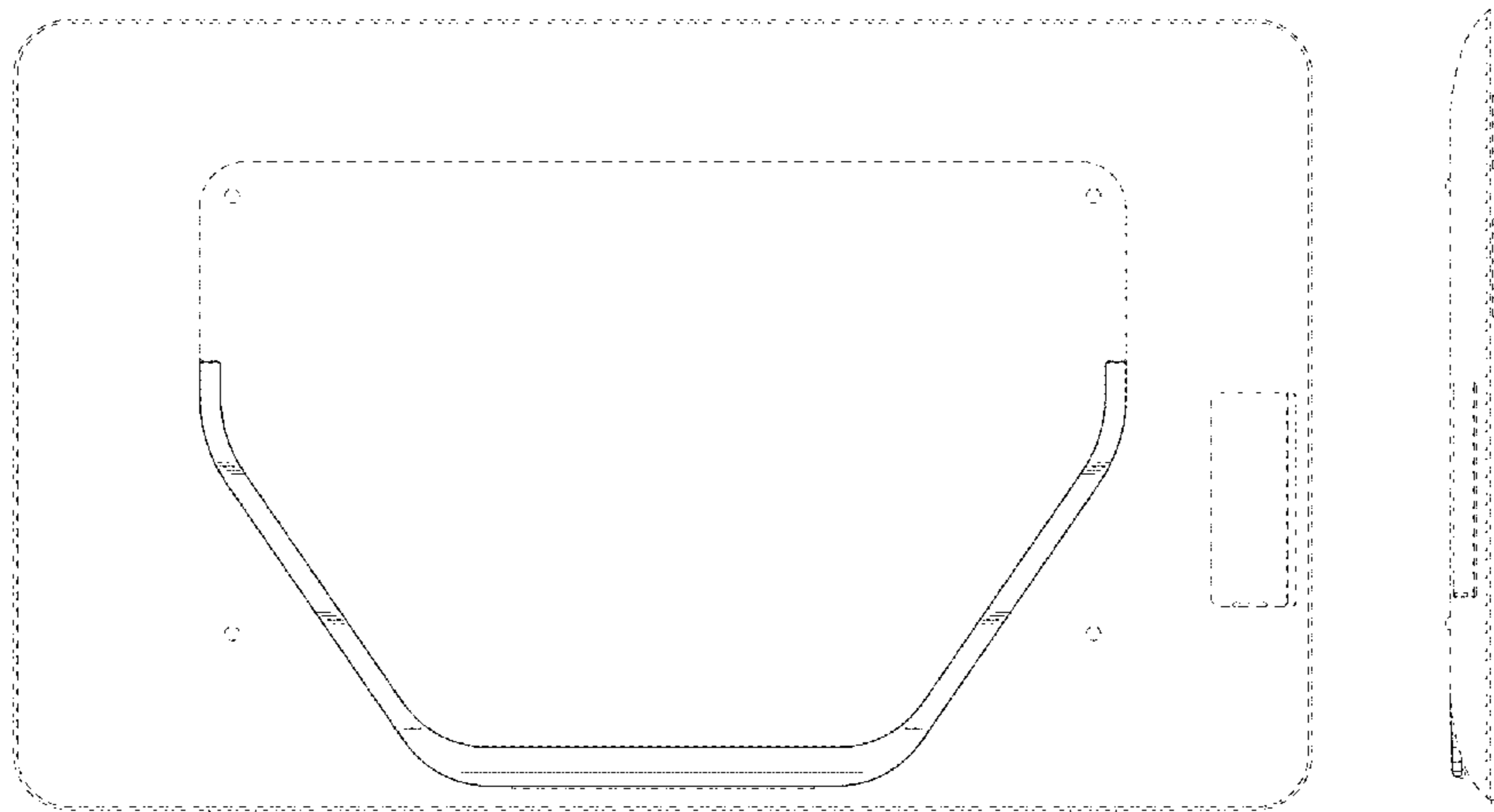

FIG.1

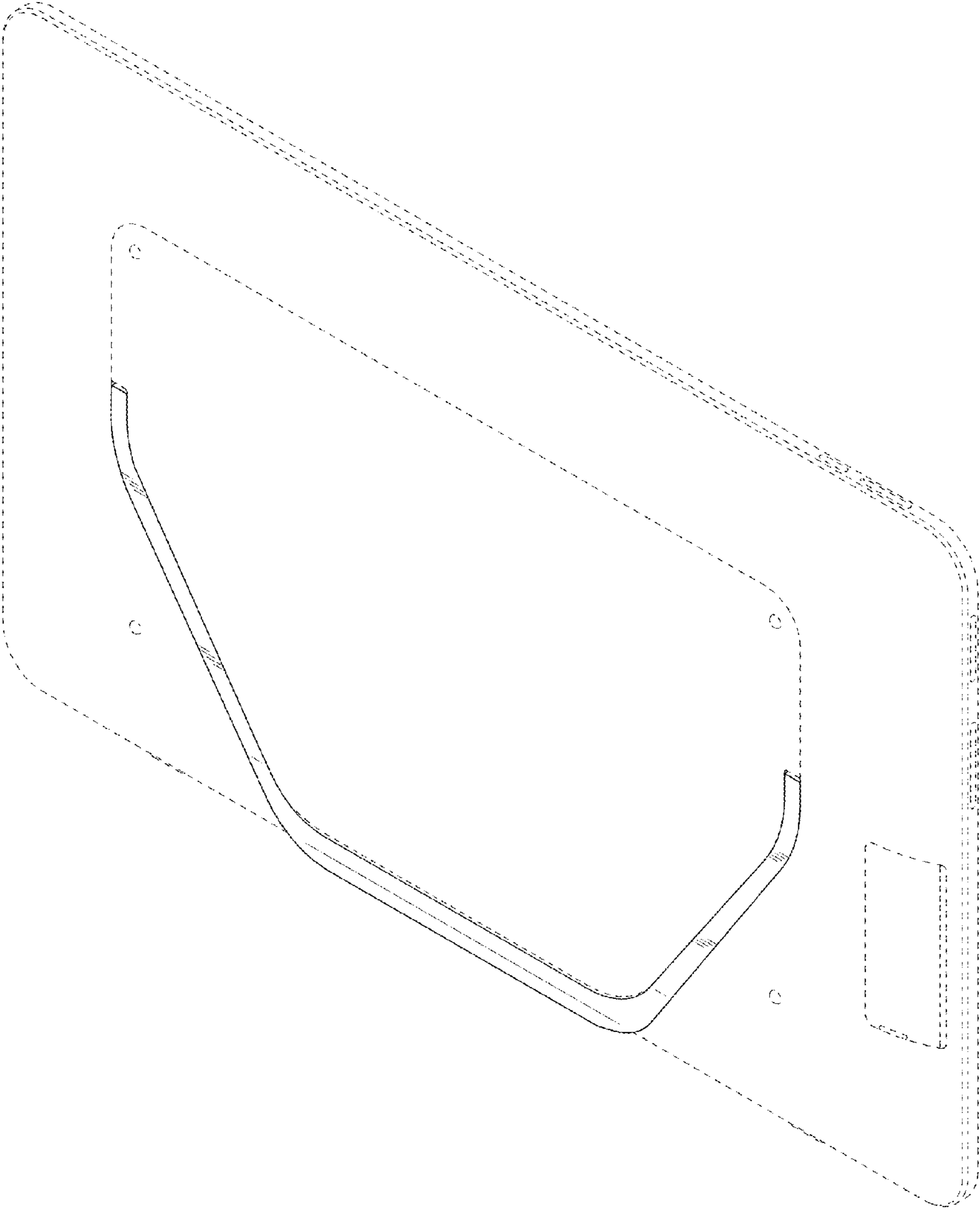

FIG.2



FIG.3

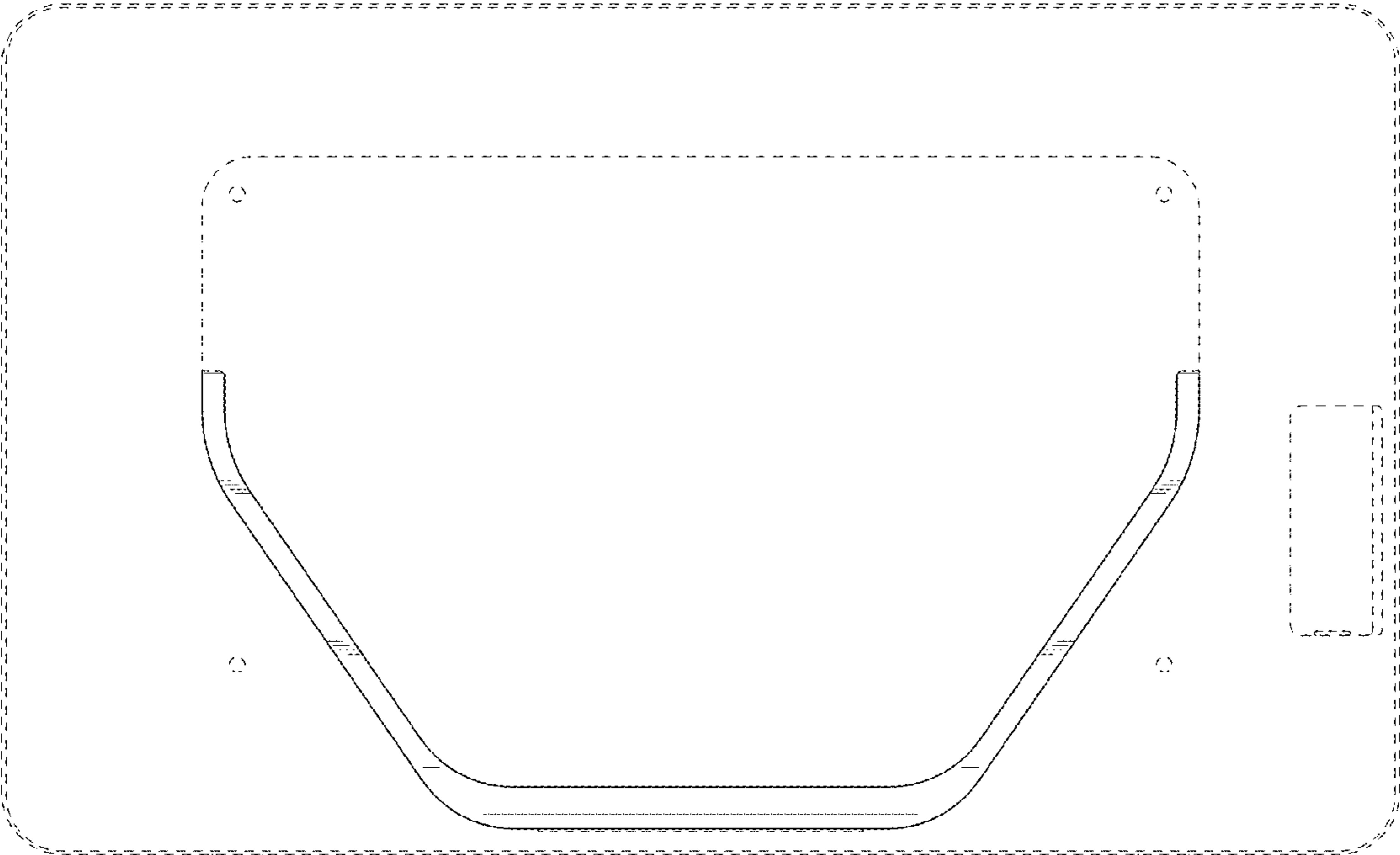

FIG.4

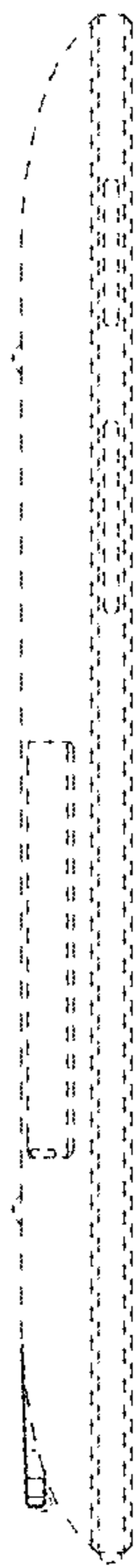

FIG.5

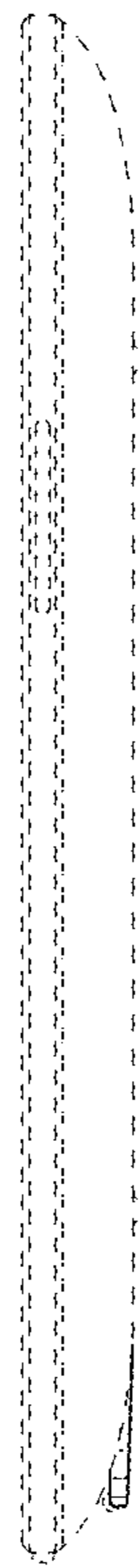

FIG.6

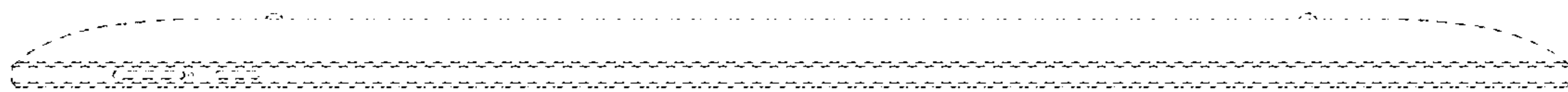

FIG.7

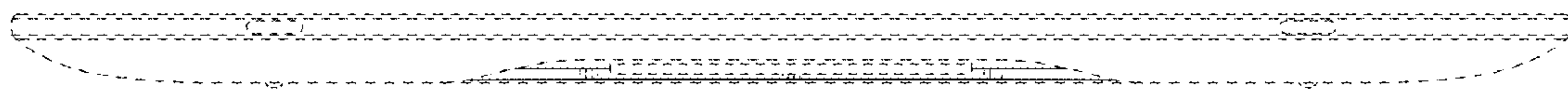

FIG.8

