

US00D747213S

(12) **United States Design Patent**
Alvarez De Cienfuegos Hernandez et al.

(10) **Patent No.:** **US D747,213 S**
(45) **Date of Patent:** **** Jan. 12, 2016**

(54) **CONTAINER**

(71) Applicant: **Conopco, Inc.**, Englewood Cliffs, NJ
(US)
(72) Inventors: **Alberto Alvarez De Cienfuegos Hernandez**, Valencia (ES); **Jose Ignacio Lavernia Company**, Valencia (ES)
(73) Assignee: **Conopco, Inc.**, Englewood Cliffs, NJ
(US)
(**) Term: **14 Years**

(21) Appl. No.: **29/490,165**

(22) Filed: **May 7, 2014**

(30) **Foreign Application Priority Data**

Mar. 21, 2014 (EM) 002430017-0002

(51) **LOC (10) Cl.** **09-01**

(52) **U.S. Cl.**
USPC **D9/559**; D9/571

(58) **Field of Classification Search**
USPC D9/516, 521-522, 529, 530, 541-544,
D9/549, 550, 552, 563, 565, 571, 574-575,
D9/682, 686, 688, 689, 692, 436, 440, 447,
D9/448; 215/382-384; 220/660, 662, 669,
220/675

CPC B65D 83/00; B65D 35/28; B65D 35/38
See application file for complete search history.

(56) **References Cited**

U.S. PATENT DOCUMENTS

D239,698 S * 4/1976 Utley D9/558
D281,861 S * 12/1985 Jones et al. D9/529
D357,416 S * 4/1995 Valentine D9/516
D378,665 S * 4/1997 Fenton et al. D9/558
D423,370 S * 4/2000 Lewin D9/572
D427,520 S * 7/2000 Crawford D9/728
D430,008 S * 8/2000 Gobe D9/695

D482,624 S * 11/2003 Hadkte et al. D9/542
D542,145 S * 5/2007 Campbell D9/565
D552,479 S * 10/2007 Mongeon et al. D9/565
D597,411 S * 8/2009 Colatrella et al. D9/542
D606,411 S * 12/2009 Mongeon et al. D9/522
D632,181 S * 2/2011 Kuzma et al. D9/542
D632,585 S * 2/2011 Jebb et al. D9/682
D649,463 S * 11/2011 Toh et al. D9/516
D659,008 S * 5/2012 Gately et al. D9/565
D678,073 S * 3/2013 Oge-Nichols et al. D9/542
D683,223 S * 5/2013 Haupt D9/522
D691,485 S * 10/2013 Beck et al. D9/564
D714,153 S 9/2014 Brewer
D729,632 S * 5/2015 Kuzma et al. D9/574
D733,567 S * 7/2015 Lindsay et al. D9/541

(Continued)

OTHER PUBLICATIONS

Family Gone Green, Shampoo that Foams and Lathers Great is More Effective, Right?, Family Gone Green, Feb. 9, 2014, p. 1. <http://www.familygonegreen.com>, , US.

(Continued)

Primary Examiner — Philip S Hyder

Assistant Examiner — Keith Frank

(74) *Attorney, Agent, or Firm* — Karen E. Klumas

(57) **CLAIM**

The ornamental design for a container, as shown and described.

DESCRIPTION

FIG. 1 is a perspective view of the top of a container showing our new design;

FIG. 2 is a front elevational view thereof;

FIG. 3 is a rear elevational view thereof;

FIG. 4 is a left side elevational view thereof;

FIG. 5 is a right side elevational view thereof;

FIG. 6 is a top plan view thereof; and,

FIG. 7 is a bottom plan view thereof.

1 Claim, 5 Drawing Sheets

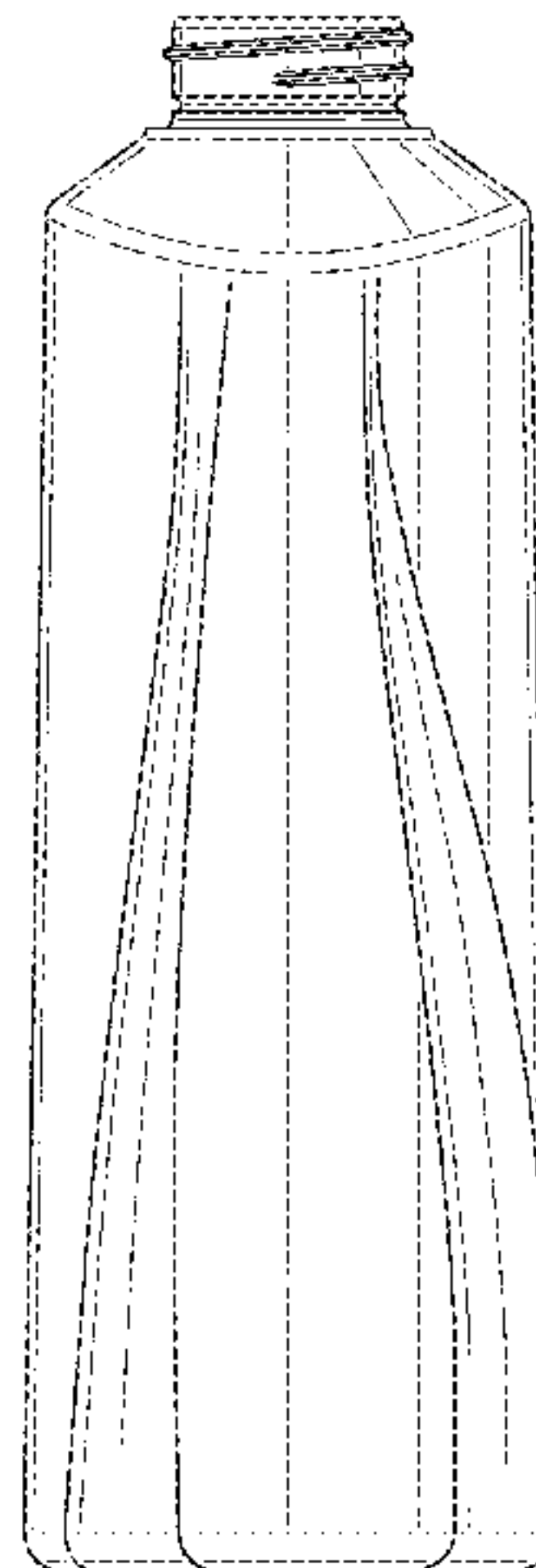
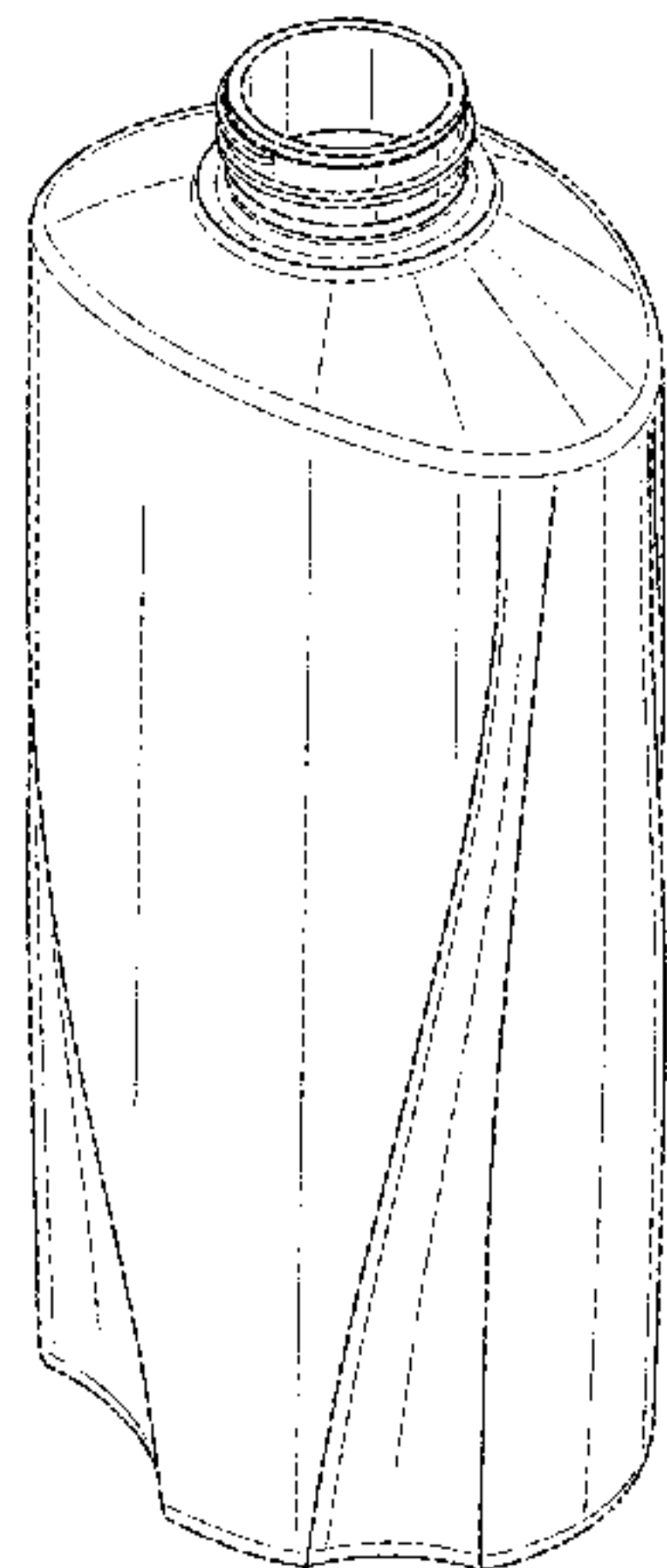

(56)

References Cited

OTHER PUBLICATIONS

U.S. PATENT DOCUMENTS

D736,636 S * 8/2015 Zaima et al. D9/522
D736,639 S * 8/2015 McCay et al. D9/552
2014/0331416 A1* 11/2014 Akinbobola et al. 8/405

Co-pending Application: Applicant: Alvarez De Cienfuegos
Hernandez et al., Filed: May 7, 2014.

* cited by examiner

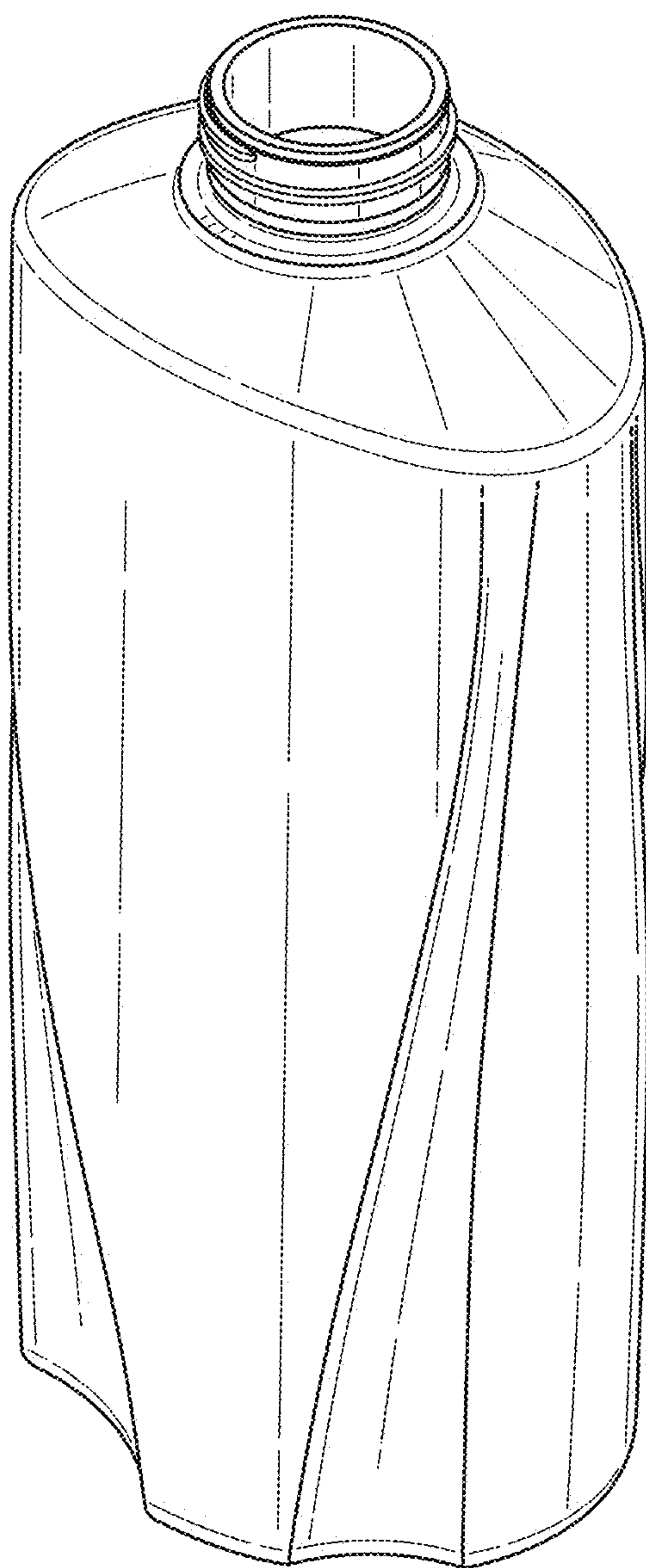

Fig. 1

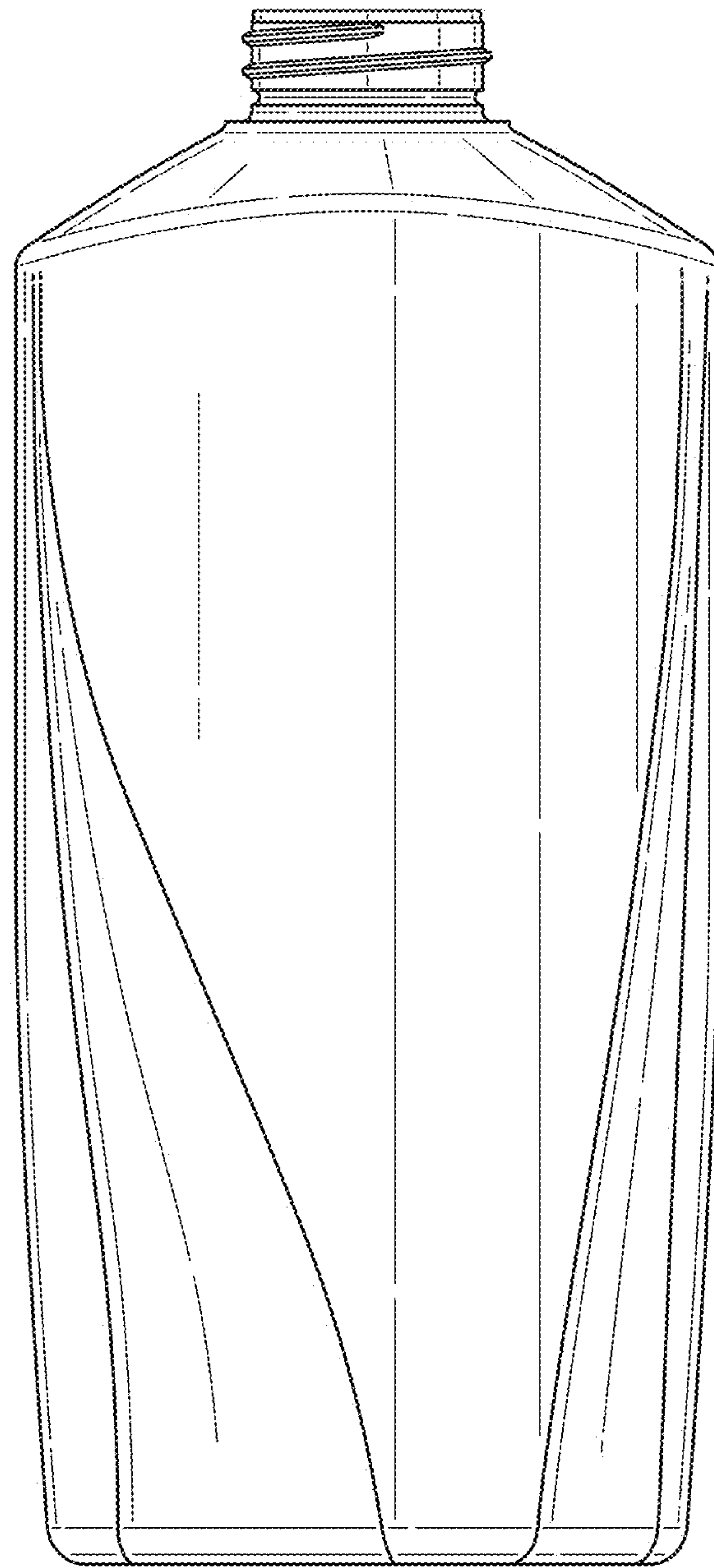

Fig. 2

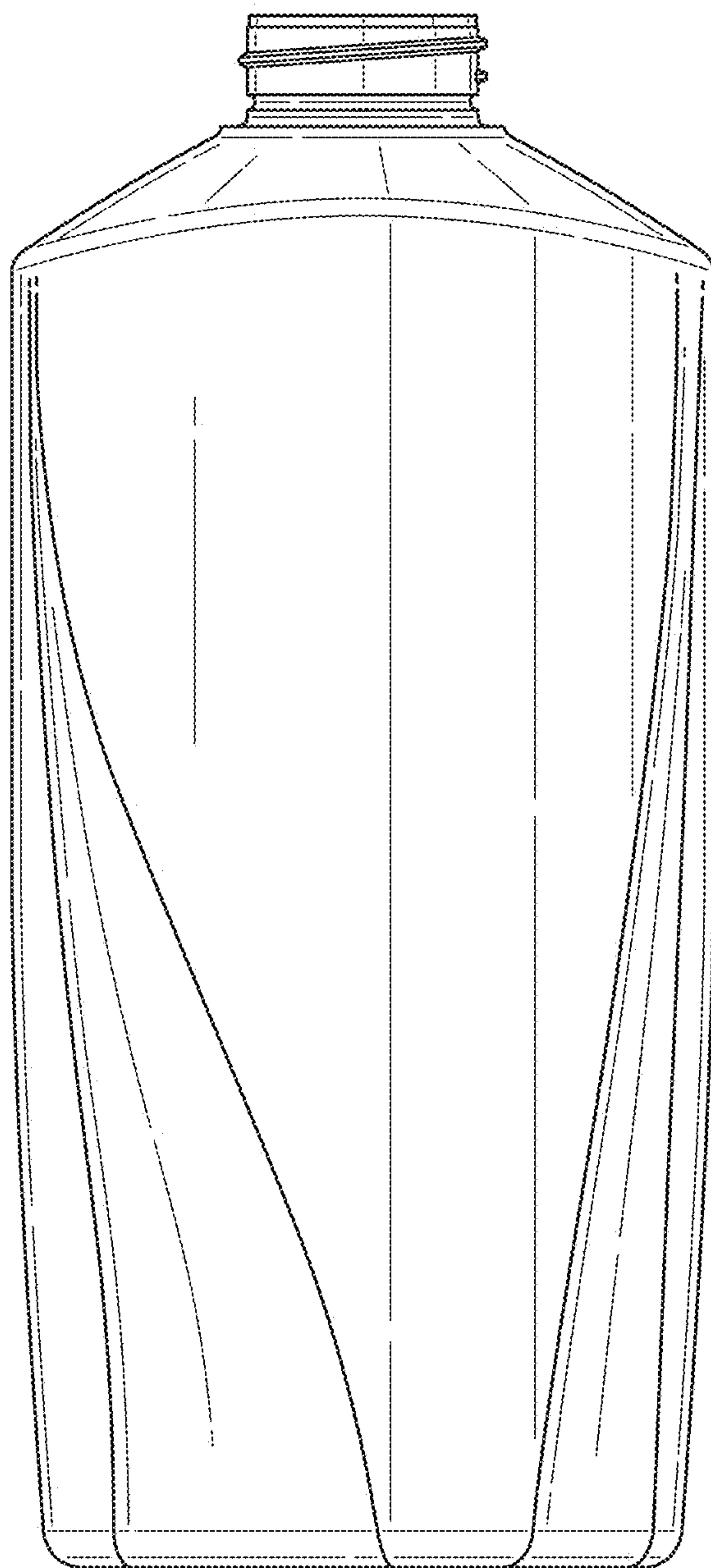

Fig. 3

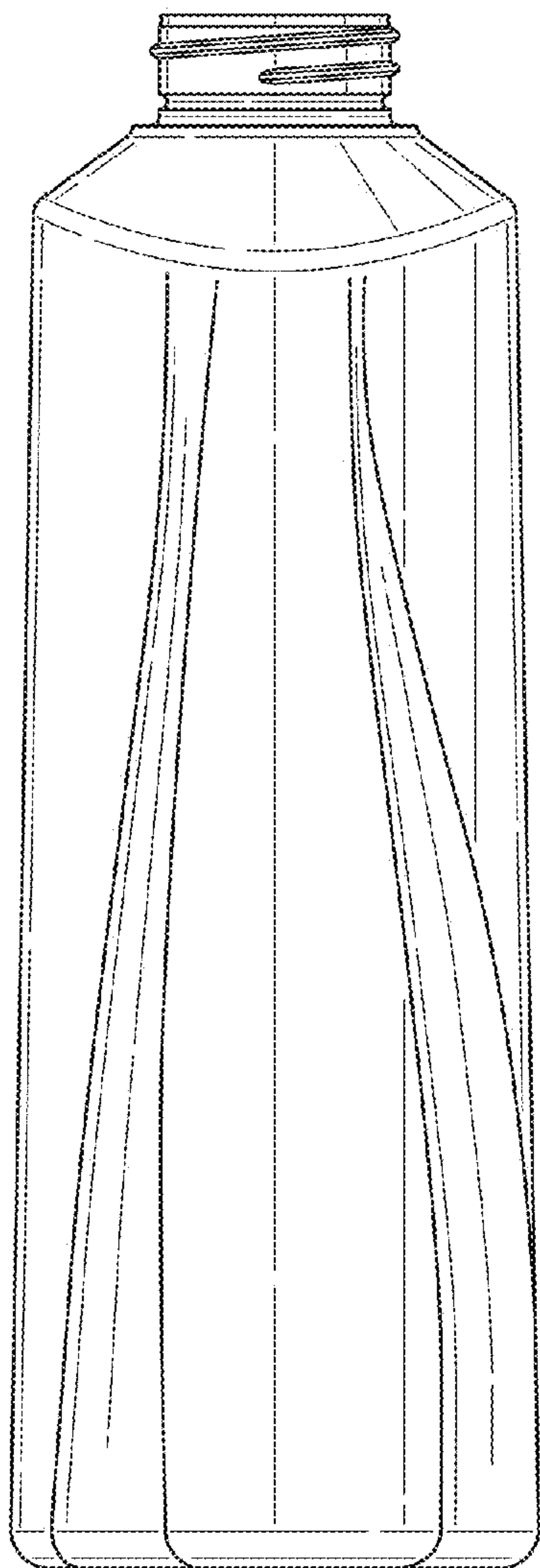

Fig. 4

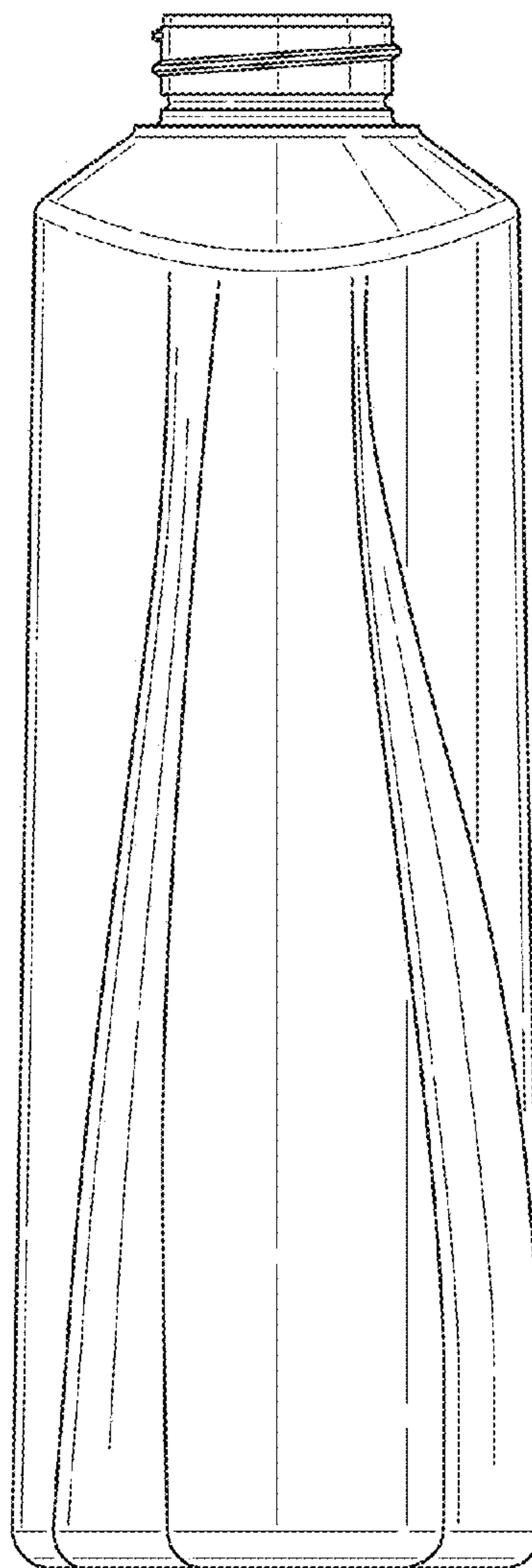

Fig. 5

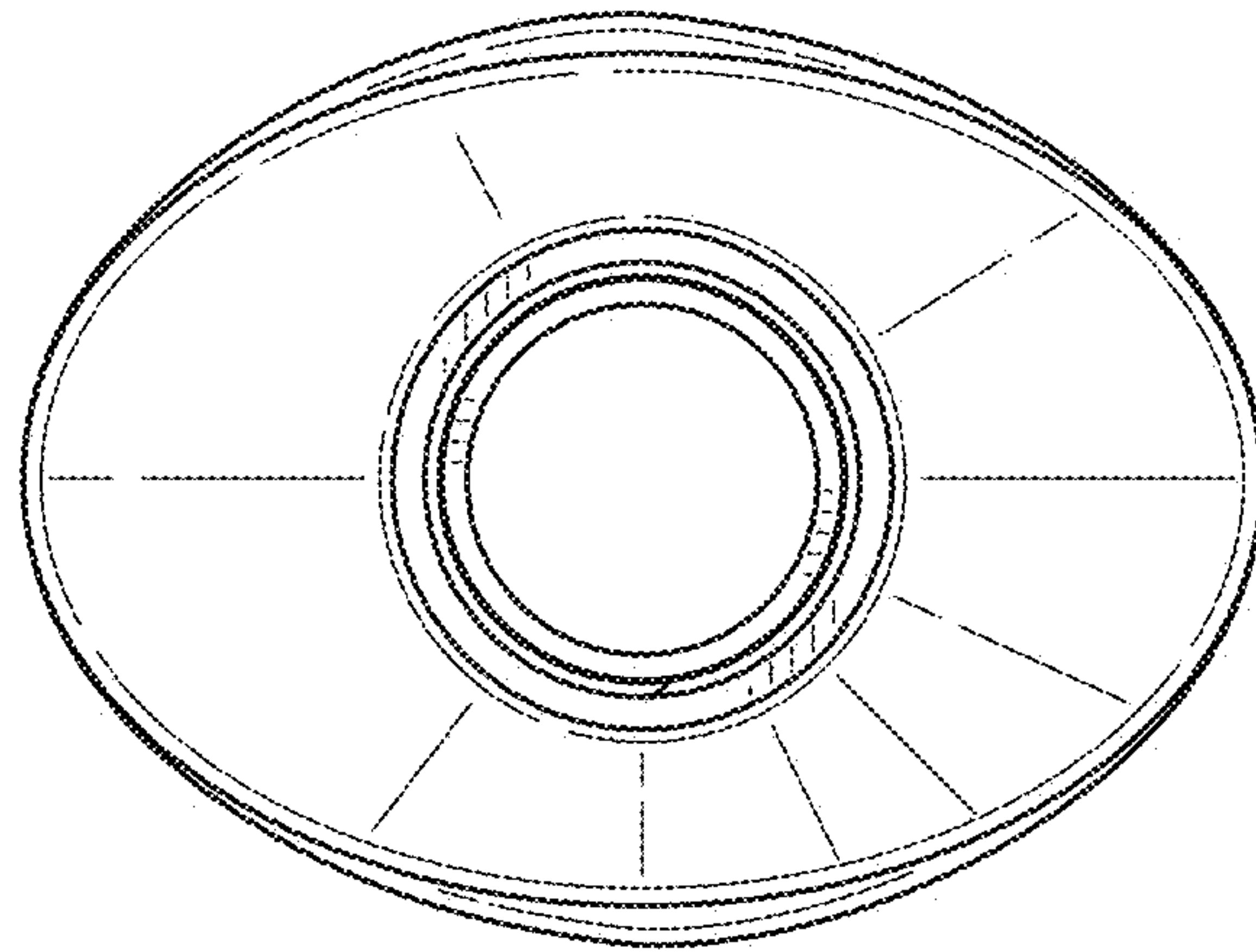

Fig. 6

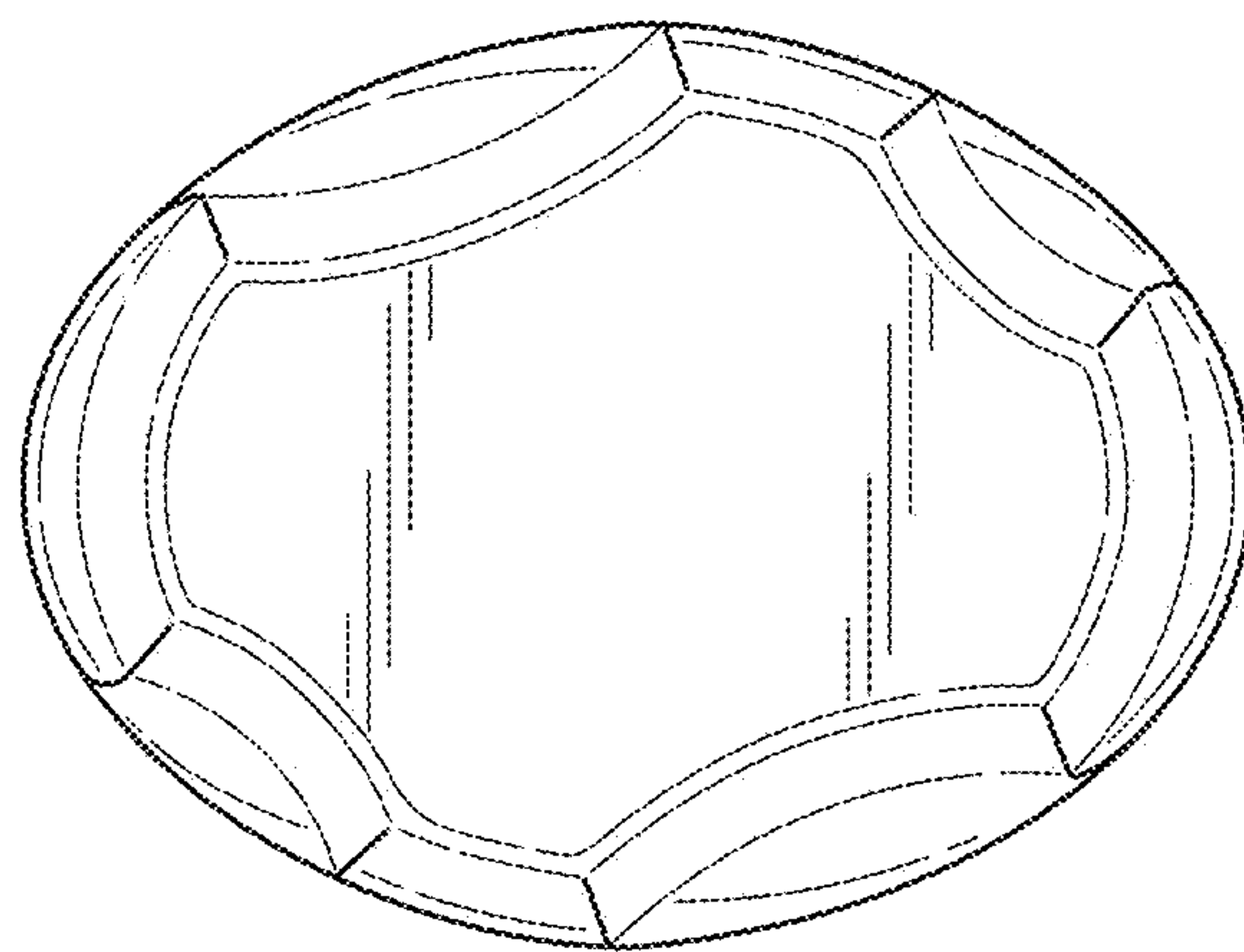

Fig. 7