



US00D747196S

(12) **United States Design Patent**
Merchant et al.

(10) **Patent No.:** **US D747,196 S**
(45) **Date of Patent:** **** *Jan. 12, 2016**

(54) **OVER THE COUNTER MEDICINAL
CONTAINER WITH SURFACE
ORNAMENTATION**

- (71) Applicant: **The Procter & Gamble Company,**
Cincinnati, OH (US)
- (72) Inventors: **Jennifer Marie Merchant,** Cincinnati,
OH (US); **Jean Martin Campbell,**
Cincinnati, OH (US); **Scott**
Cunningham, Cincinnati, OH (US);
Kevin Wimmer, Union Township, OH
(US)
- (73) Assignee: **The Procter & Gamble Company,**
Cincinnati, OH (US)

- (*) Notice: This patent is subject to a terminal dis-
claimer.
- (**) Term: **14 Years**
- (21) Appl. No.: **29/471,614**
- (22) Filed: **Nov. 4, 2013**

Related U.S. Application Data

- (63) Continuation-in-part of application No. 29/401,256,
filed on Sep. 9, 2011, now Pat. No. Des. 703,532.
- (51) **LOC (10) Cl.** **09-07**
- (52) **U.S. Cl.**
USPC **D9/434**
- (58) **Field of Classification Search**
USPC D11/95, 99; D5/20, 63; D9/414, 415,
D9/423, 424, 425, 432, 433, 434, 435, 759,
D9/760, 770; D19/1, 27; 206/775, 776,
206/557, 823; D7/546, 549, 602, 550.1,
D7/703; 229/87.08, 123.1, 123.3, 221
CPC B65D 5/4204; B65D 15/08; B65D 1/34;
B65D 65/22; B65D 2577/205; B65D 5/706;
B65D 5/705; A45D 40/22
See application file for complete search history.

(56) **References Cited**

U.S. PATENT DOCUMENTS

D79,888 S *	11/1929	MacMillan	D9/432
D259,472 S *	6/1981	Grodin	D9/432
D554,500 S *	11/2007	Bone et al.	D9/434
D608,636 S *	1/2010	Seol	D9/432
D656,016 S *	3/2012	Hablutzel et al.	D9/434
D661,193 S *	6/2012	Merchant et al.	D9/516
D691,887 S *	10/2013	Macaulay et al.	D9/516
D692,299 S *	10/2013	Macaulay et al.	D9/434
D703,532 S *	4/2014	Merchant et al.	D9/434
D703,533 S *	4/2014	Merchant et al.	D9/434
D706,630 S *	6/2014	Merchant et al.	D9/434
D707,122 S *	6/2014	Merchant et al.	D9/434
D723,915 S *	3/2015	Abel et al.	D9/434

* cited by examiner

Primary Examiner — Robert M Spear

Assistant Examiner — Marissa J Cash

(74) *Attorney, Agent, or Firm* — Alexandra A. Anoff

(57) **CLAIM**

The ornamental design for an over the counter medicinal container with surface ornamentation, as shown and described.

DESCRIPTION

The present application file contains at least one drawing executed in color. Copies of this patent or patent application publication with color drawing(s) will be provided by the Office upon request and payment of the necessary fee.

FIG. 1 is a perspective view of a first embodiment of an over the counter medicinal container with surface ornamentation embodying our new design;

FIG. 2 is a front view thereof;

FIG. 3 is a rear view thereof;

FIG. 4 is a left side view thereof;

FIG. 5 is a right side view thereof;

FIG. 6 is a top view thereof;

FIG. 7 is a bottom view thereof;

FIG. 8 is a perspective view of a second embodiment of an over the counter medicinal container with surface ornamentation embodying our new design;

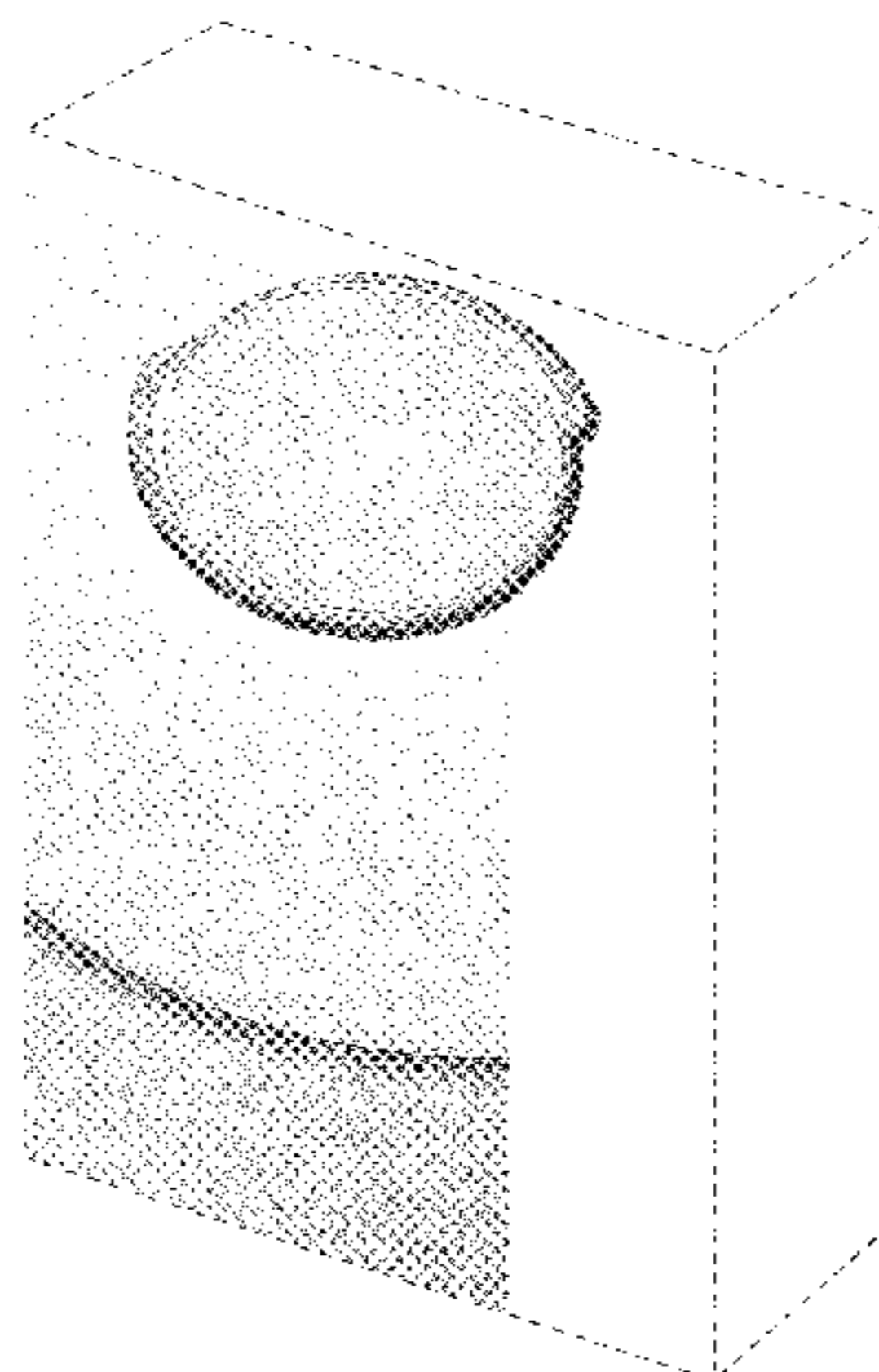

FIG. 9 is a front view thereof;
FIG. 10 is a rear view thereof;
FIG. 11 is a left side view thereof;
FIG. 12 is a right side view thereof;
FIG. 13 is a top view thereof;
FIG. 14 is a bottom view thereof;
FIG. 15 is a perspective view of a third embodiment of an over the counter medicinal container with surface ornamentation embodying our new design;
FIG. 16 is a front view thereof;
FIG. 17 is a rear view thereof;
FIG. 18 is a left side view thereof;
FIG. 19 is a right side view thereof;
FIG. 20 is a bottom view thereof;
FIG. 21 is a top view thereof;
FIG. 22 is a perspective view of a fourth embodiment of an over the counter medicinal container with surface ornamentation embodying our new design;
FIG. 23 is a front view thereof;

FIG. 24 is a rear view thereof;
FIG. 25 is a left side view thereof;
FIG. 26 is a right side view thereof;
FIG. 27 is a bottom view thereof;
FIG. 28 is a top view thereof;
FIG. 29 is a perspective view of a fifth embodiment of an over the counter medicinal container with surface ornamentation embodying our new design;
FIG. 30 is a front view thereof;
FIG. 31 is a left side view thereof;
FIG. 32 is a right side view thereof;
FIG. 33 is a rear view thereof;
FIG. 34 is a top view thereof; and,
FIG. 35 is a bottom view thereof.
Broken lines are included herein for illustrative purposes only and form no part of the claimed design. In FIGS. 1-2 and FIGS. 22-24, the stippling represents color contrast.

**1 Claim, 12 Drawing Sheets
(6 of 12 Drawing Sheet(s) Filed in Color)**

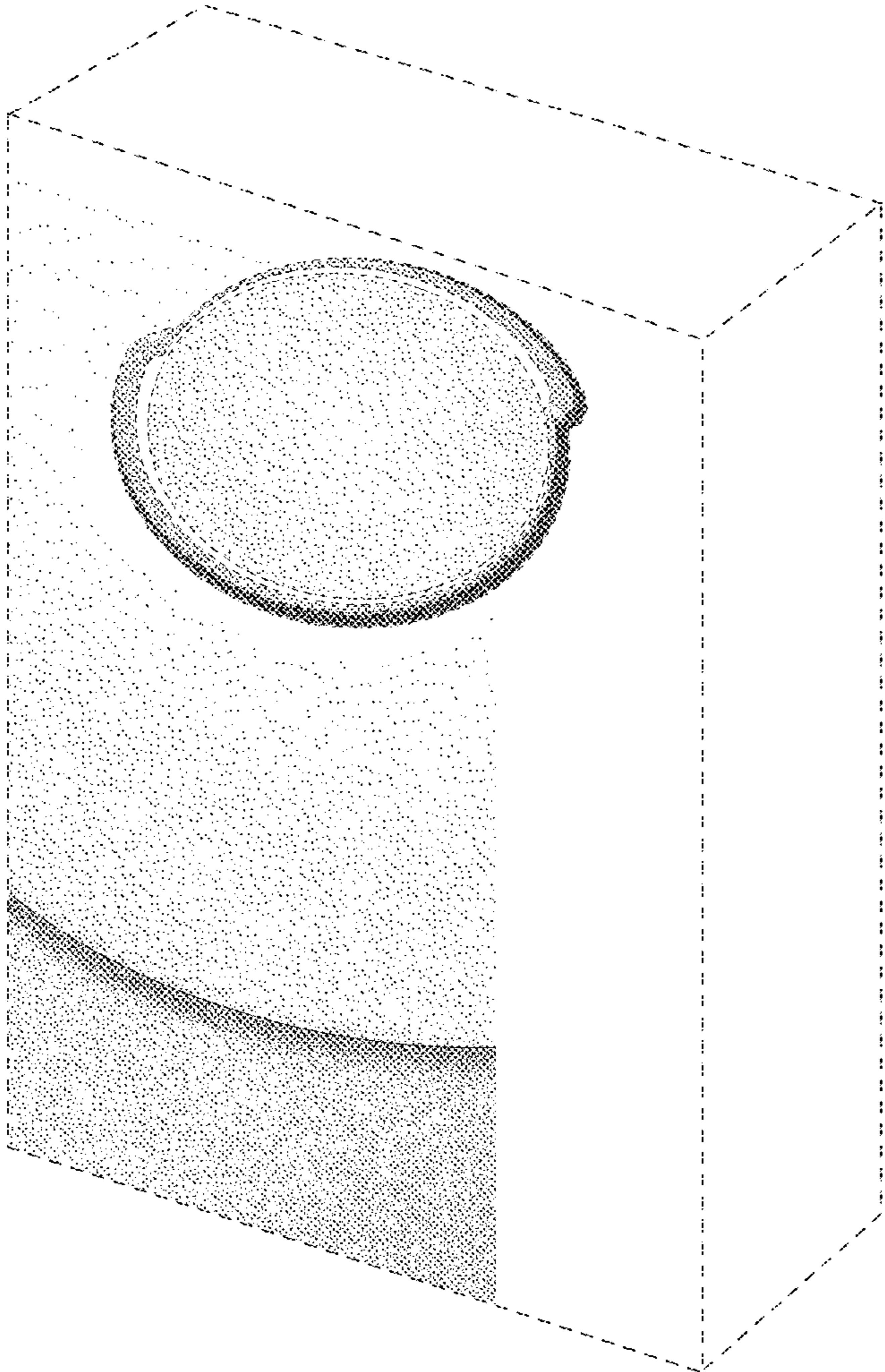

Fig. 1

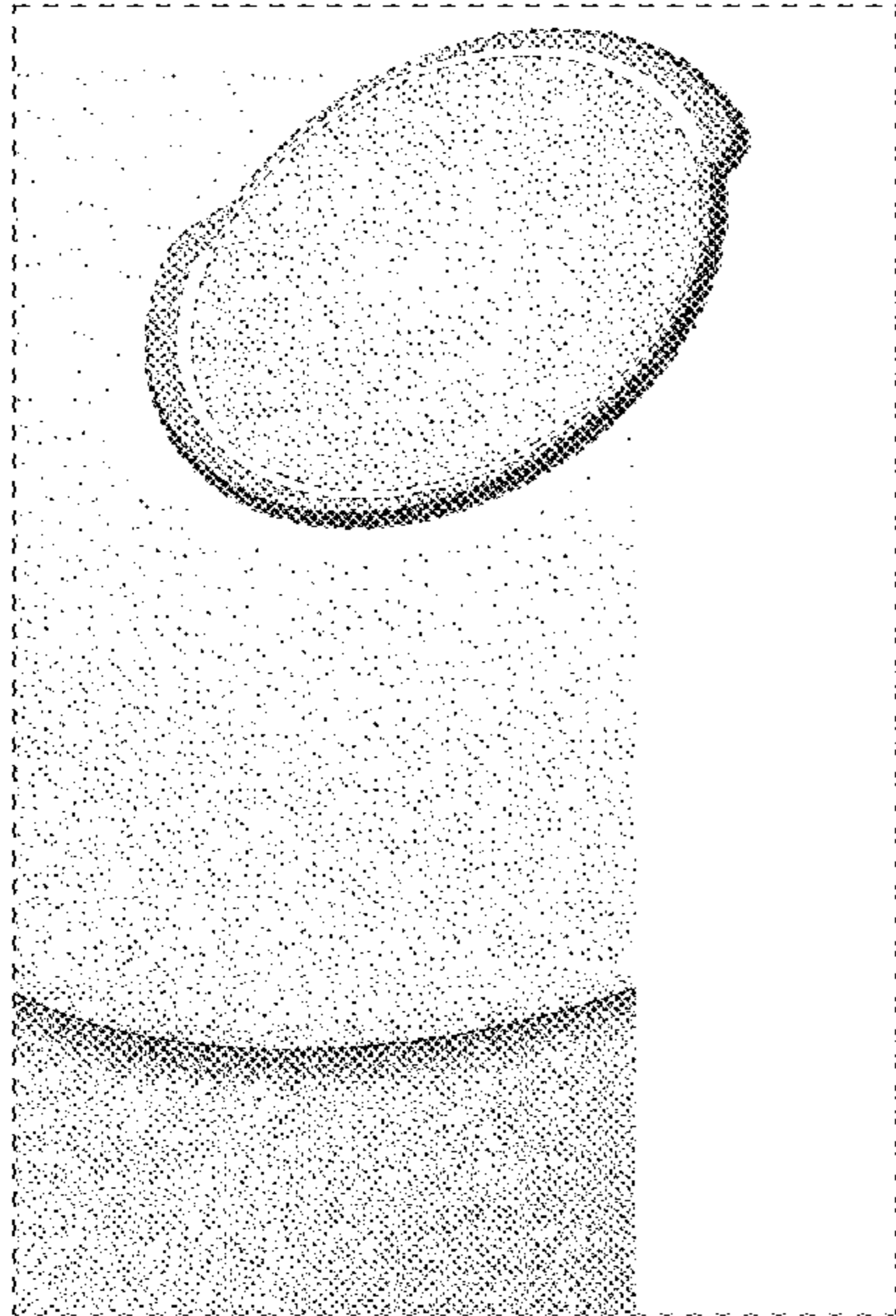

Fig. 2

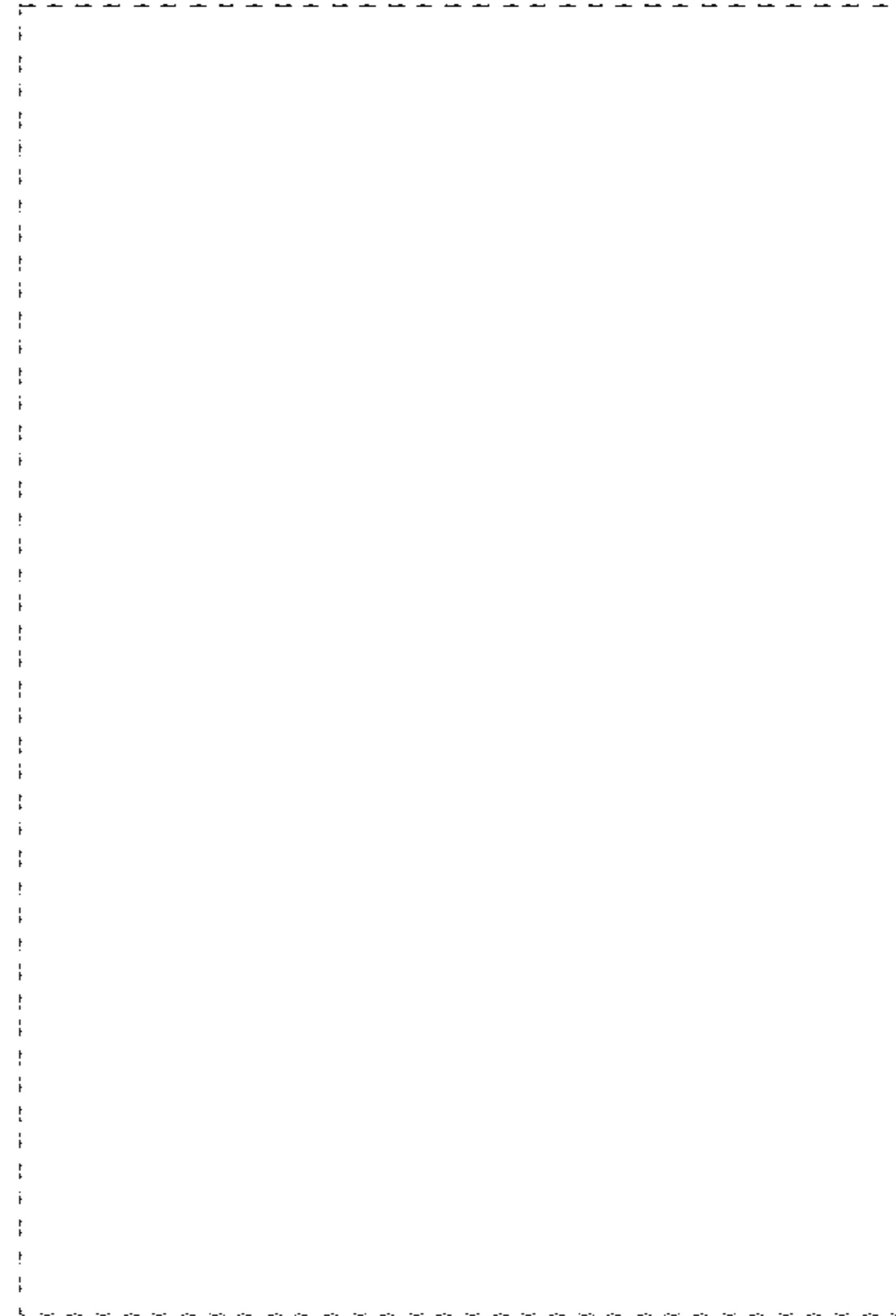

Fig. 3



Fig. 4

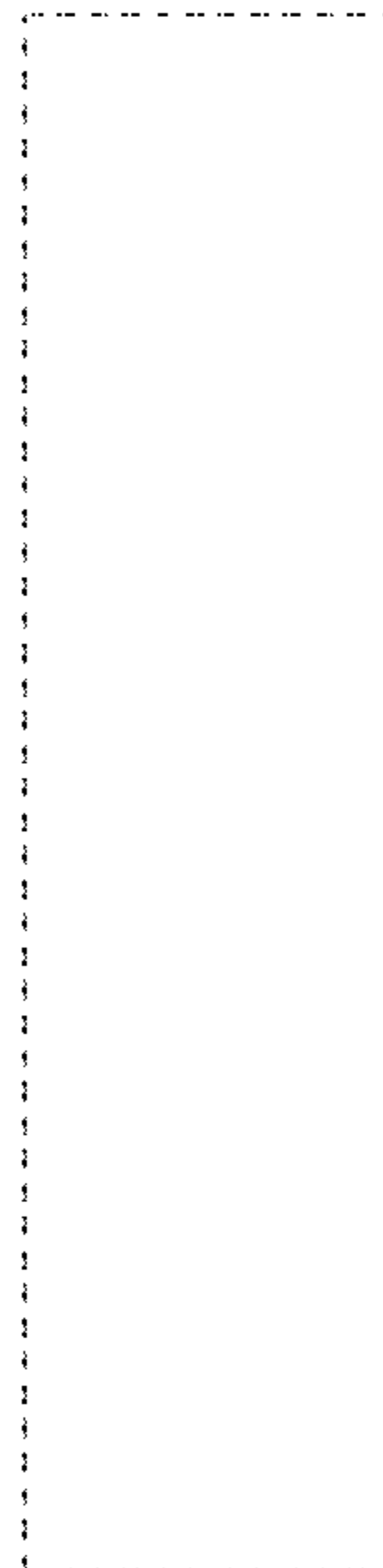

Fig. 5



Fig. 6

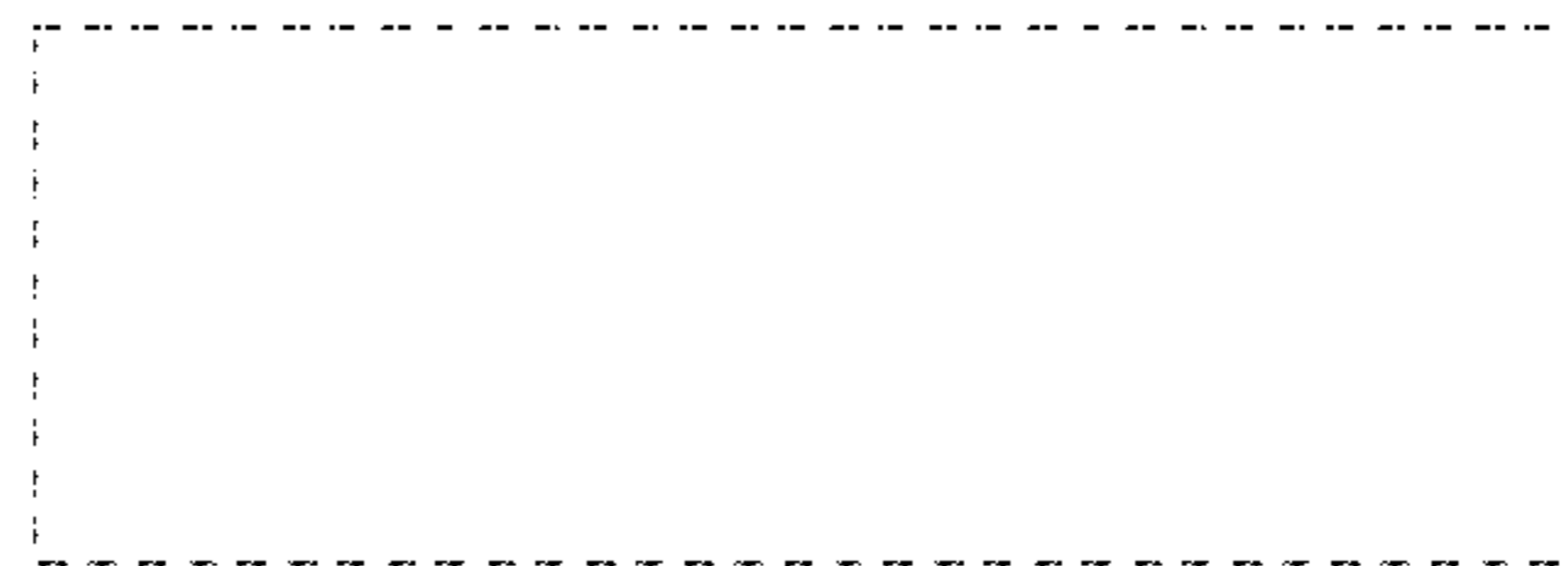

Fig. 7

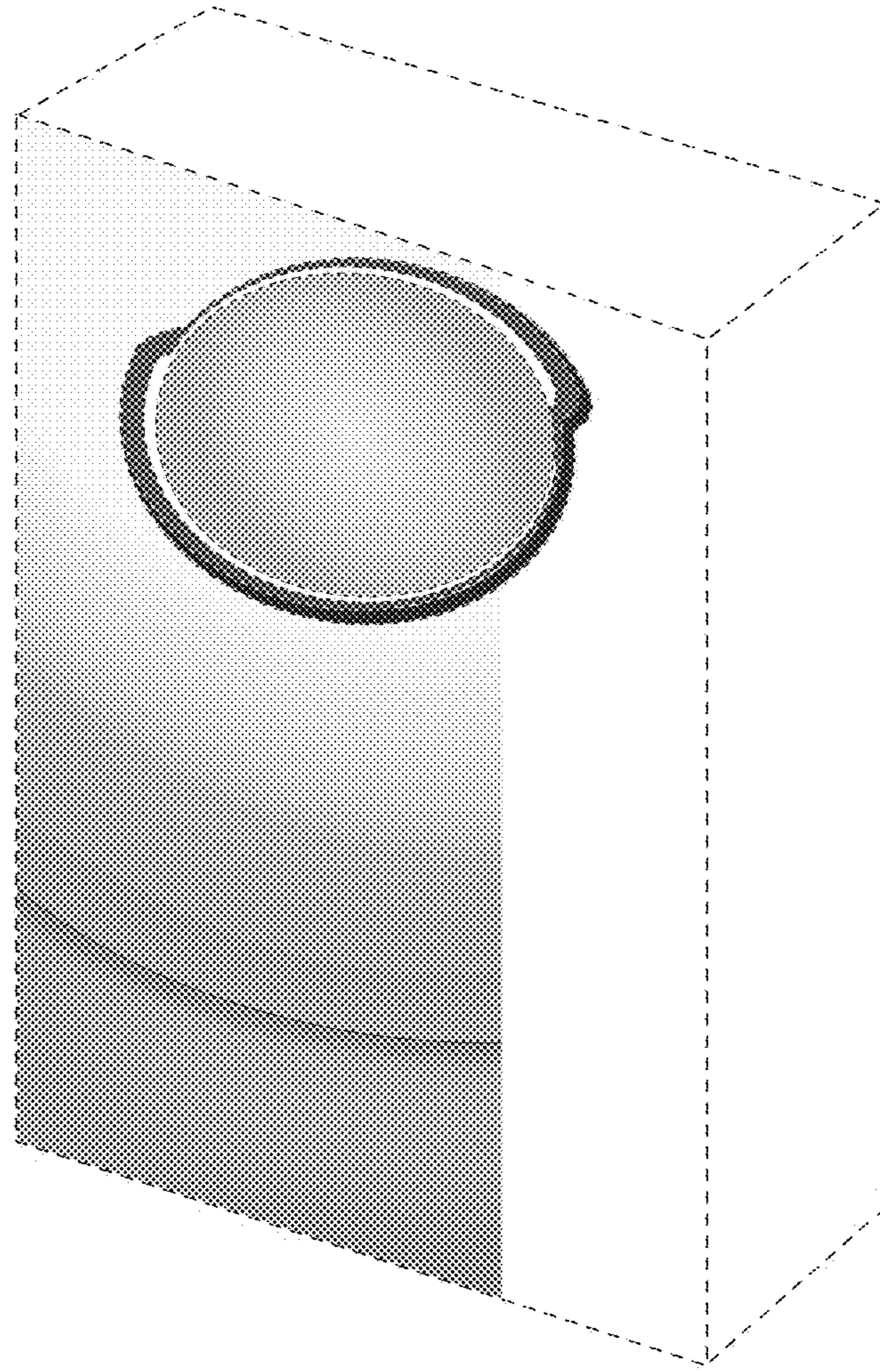

Fig. 8

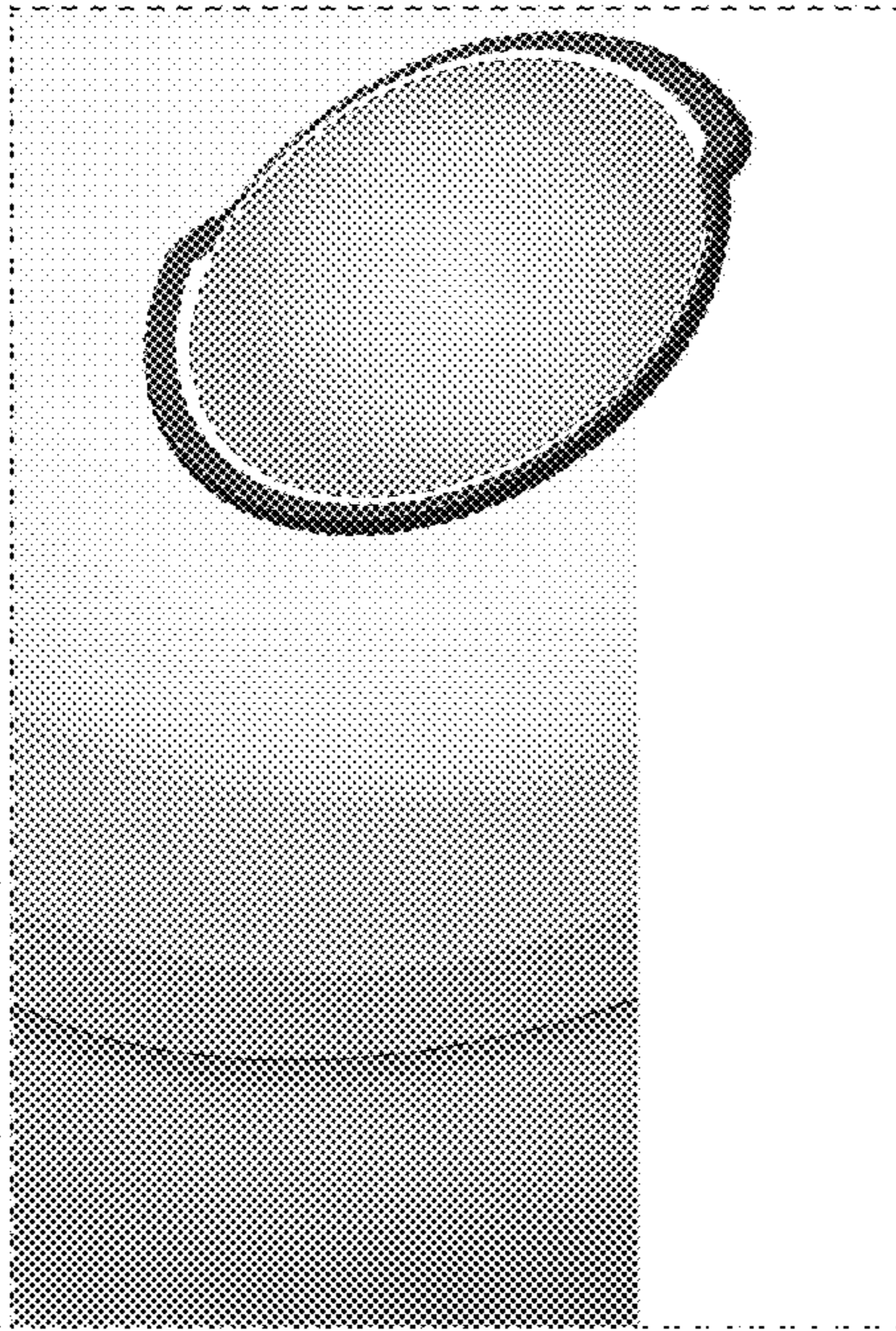

Fig. 9

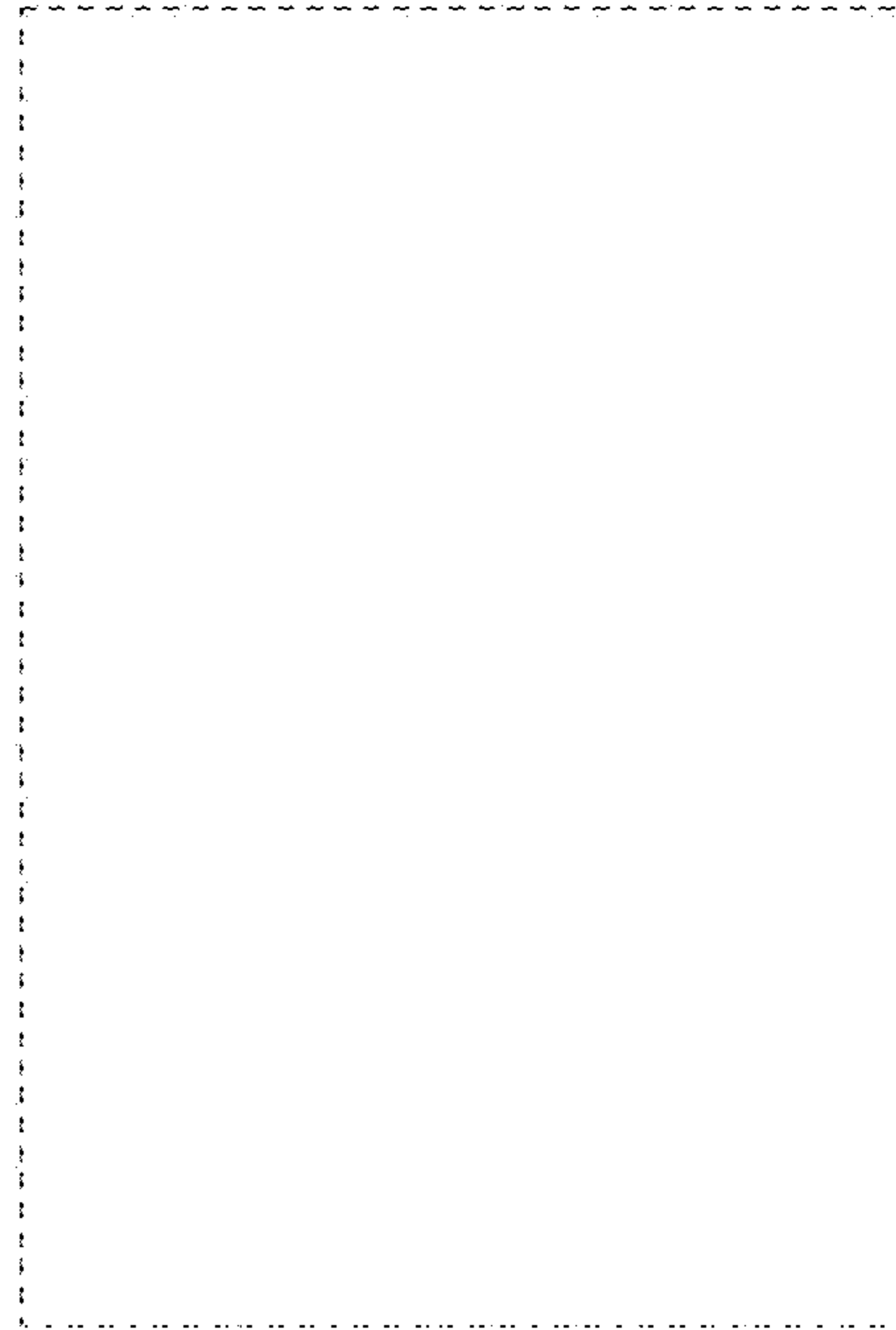

Fig. 10

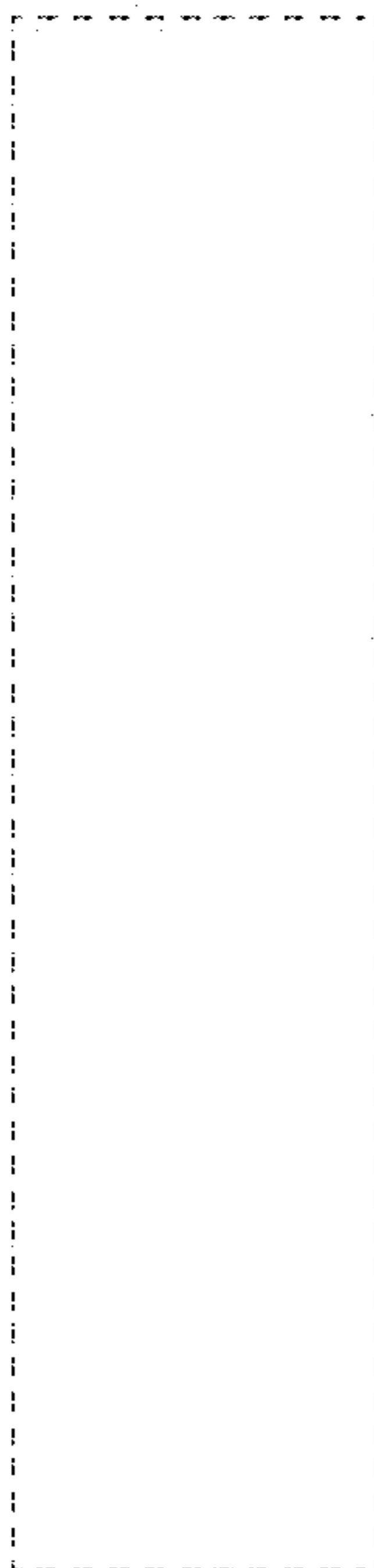

Fig. 11

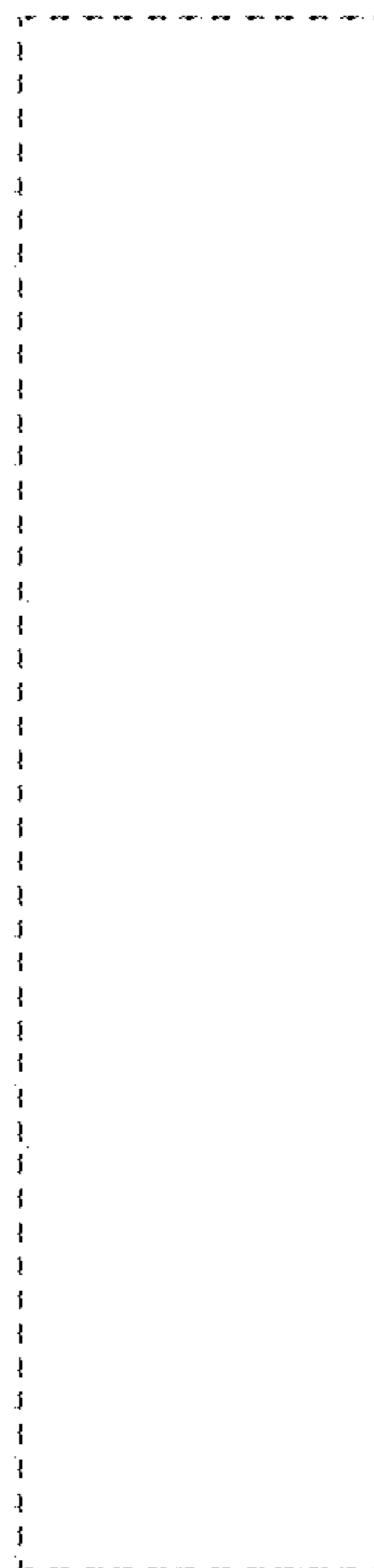

Fig. 12

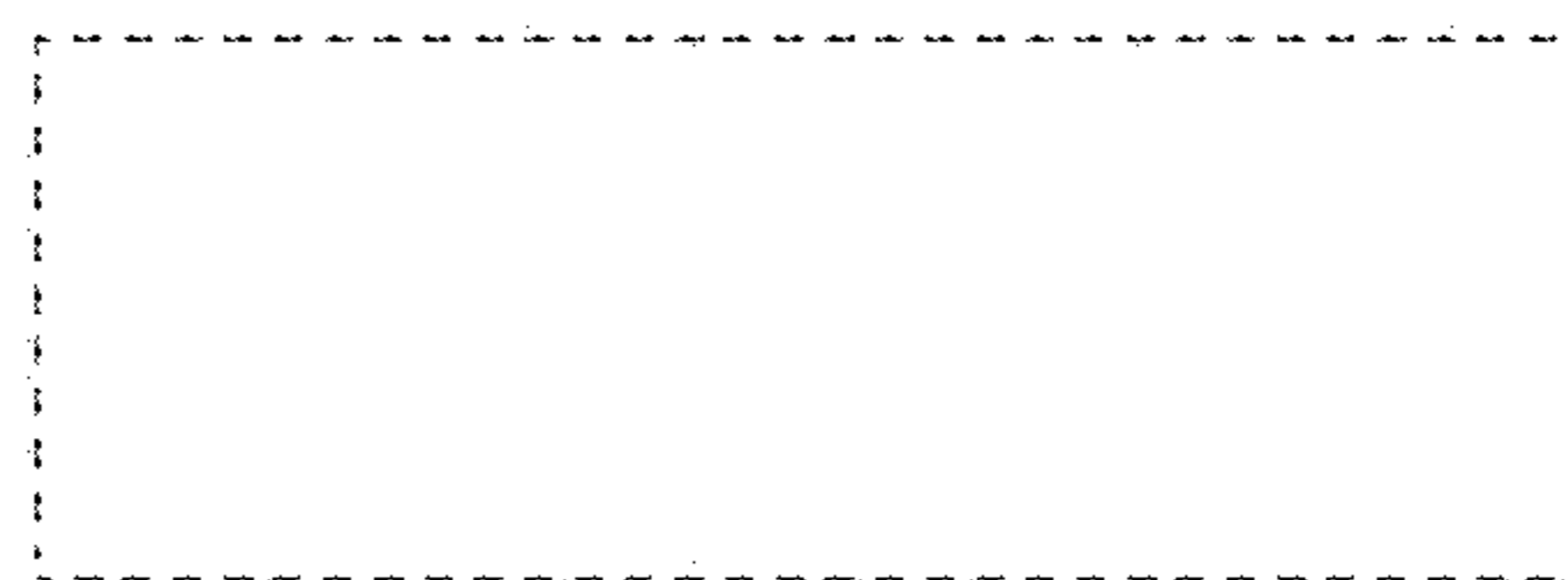

Fig. 13



Fig. 14

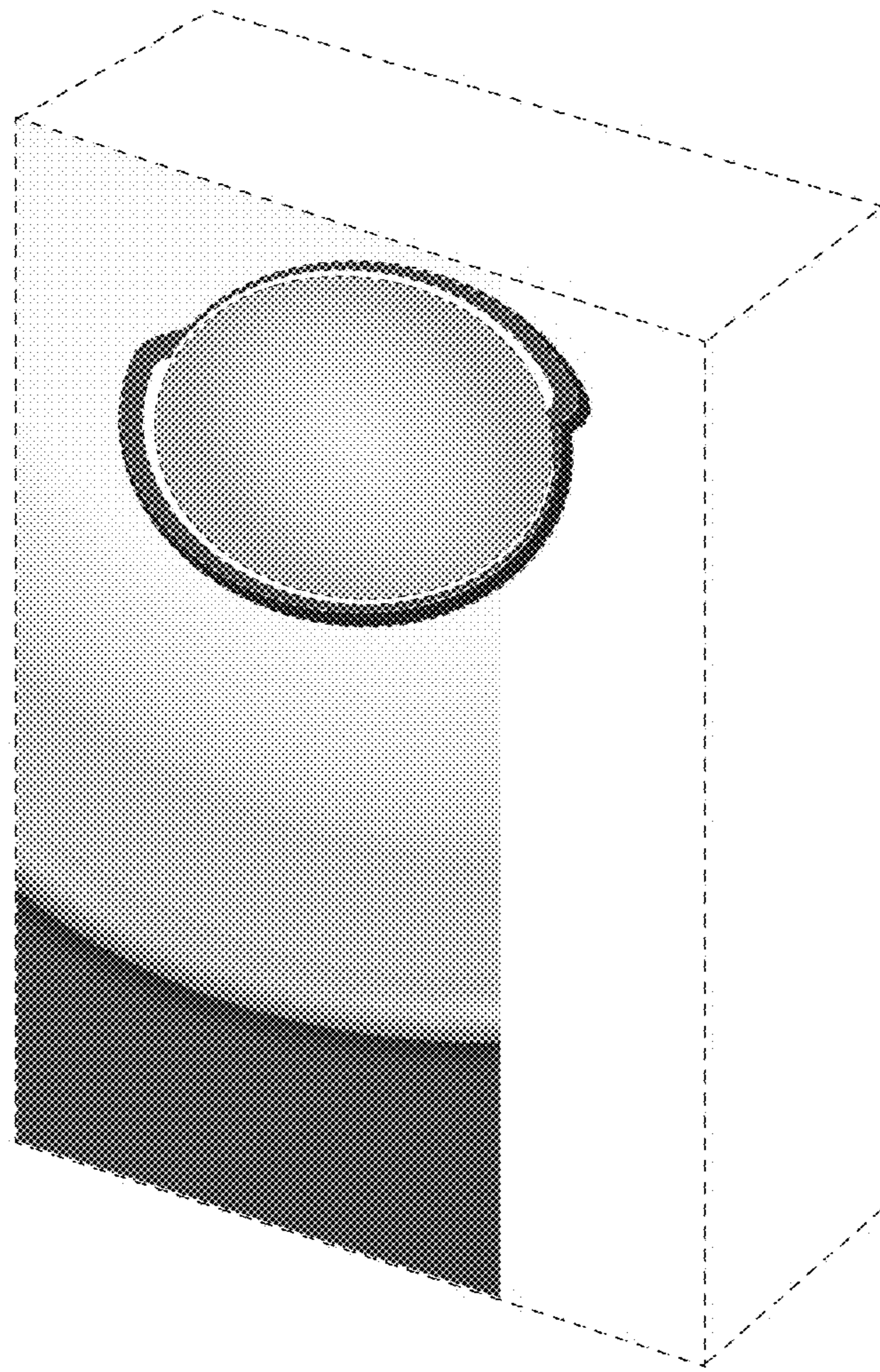

Fig. 15

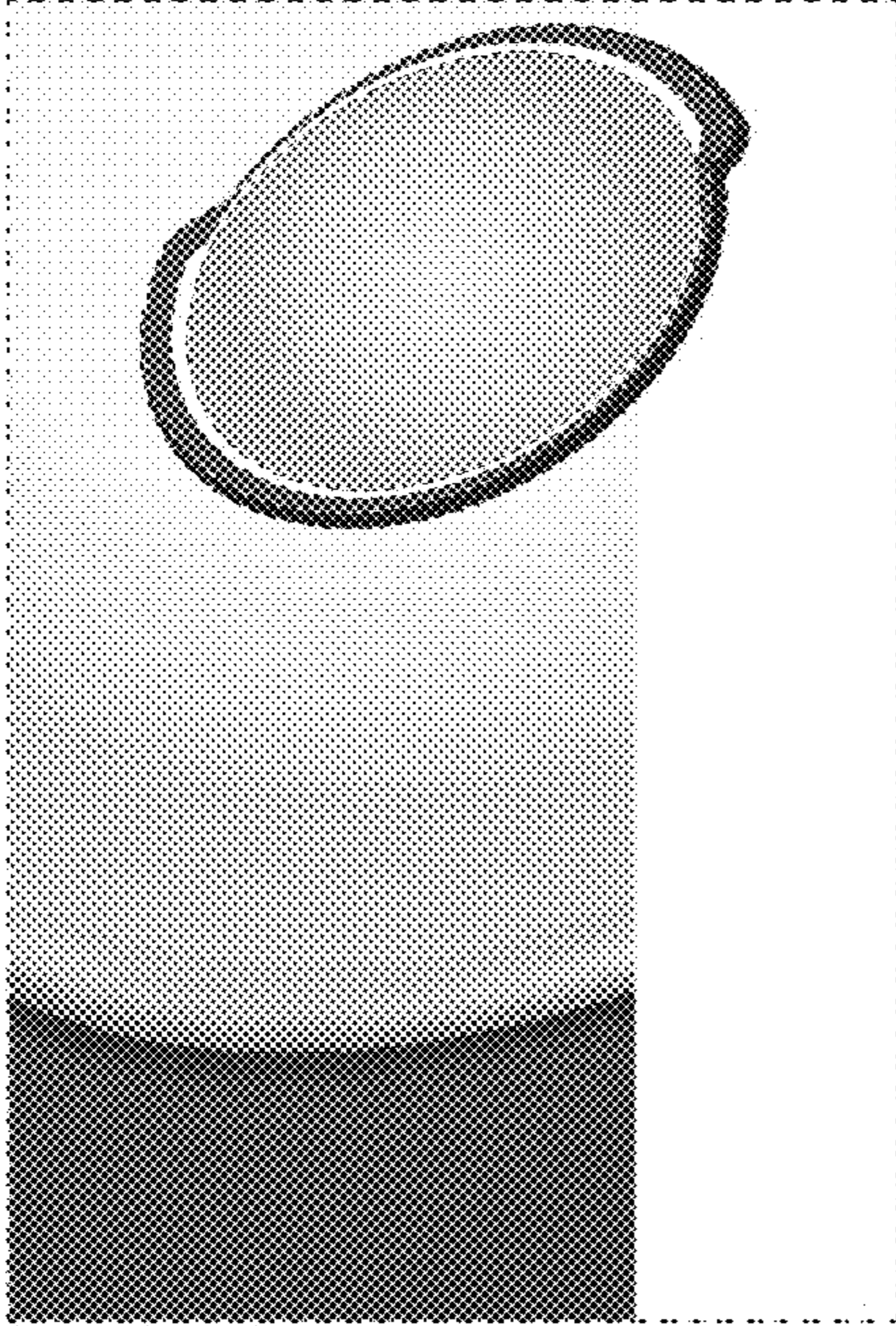

Fig. 16

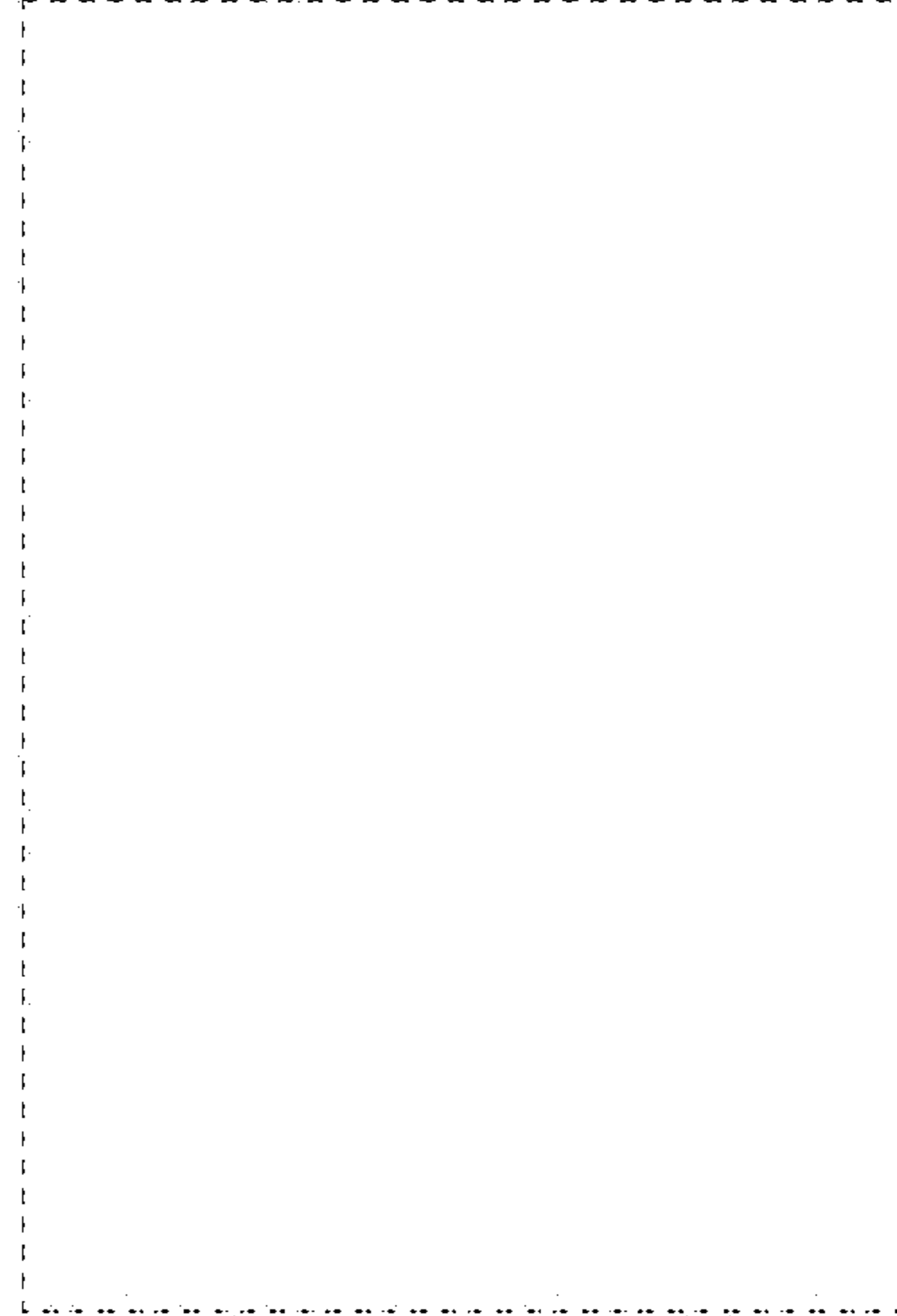

Fig. 17

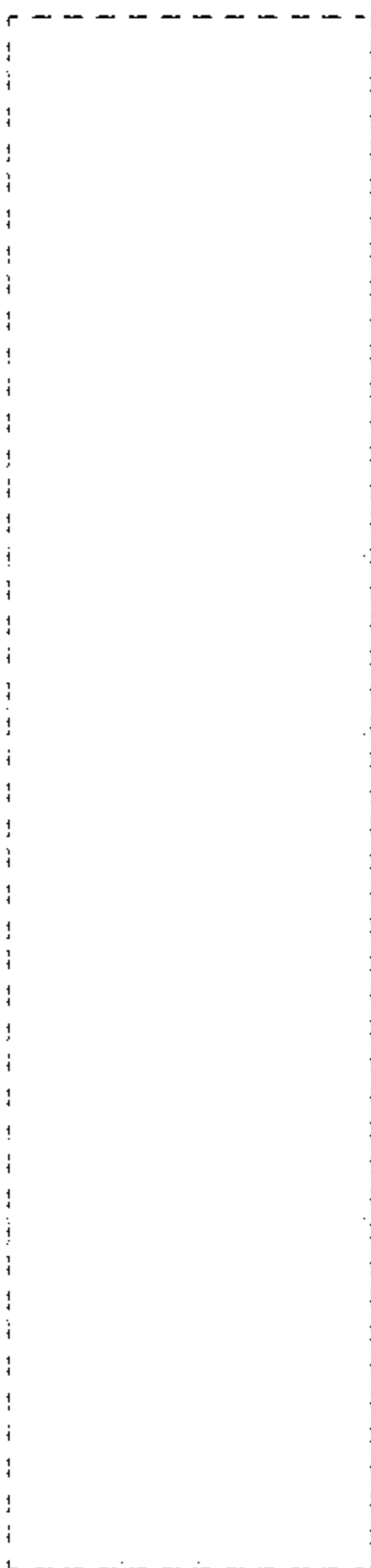

Fig. 18

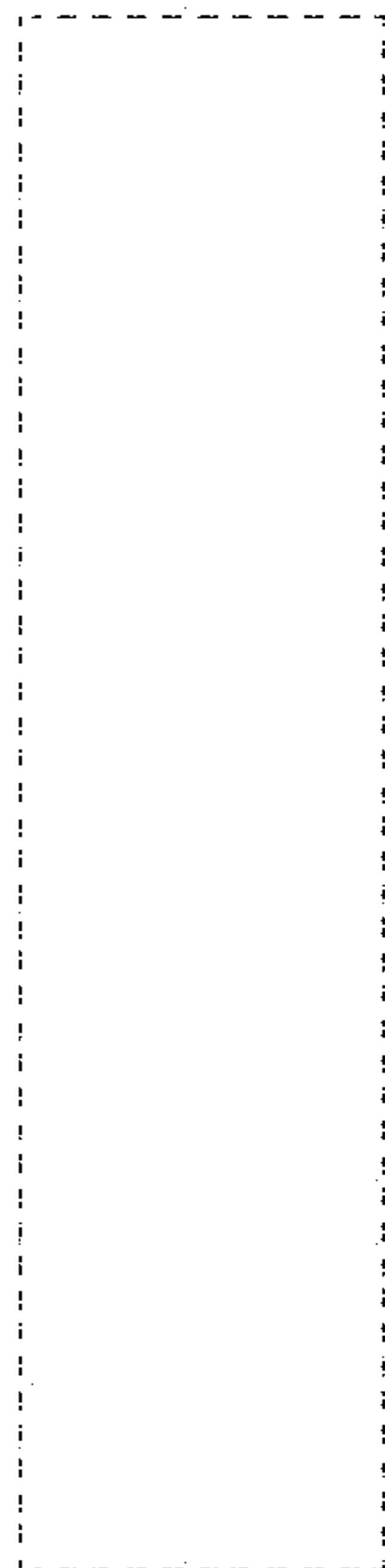

Fig. 19



Fig. 20



Fig. 21

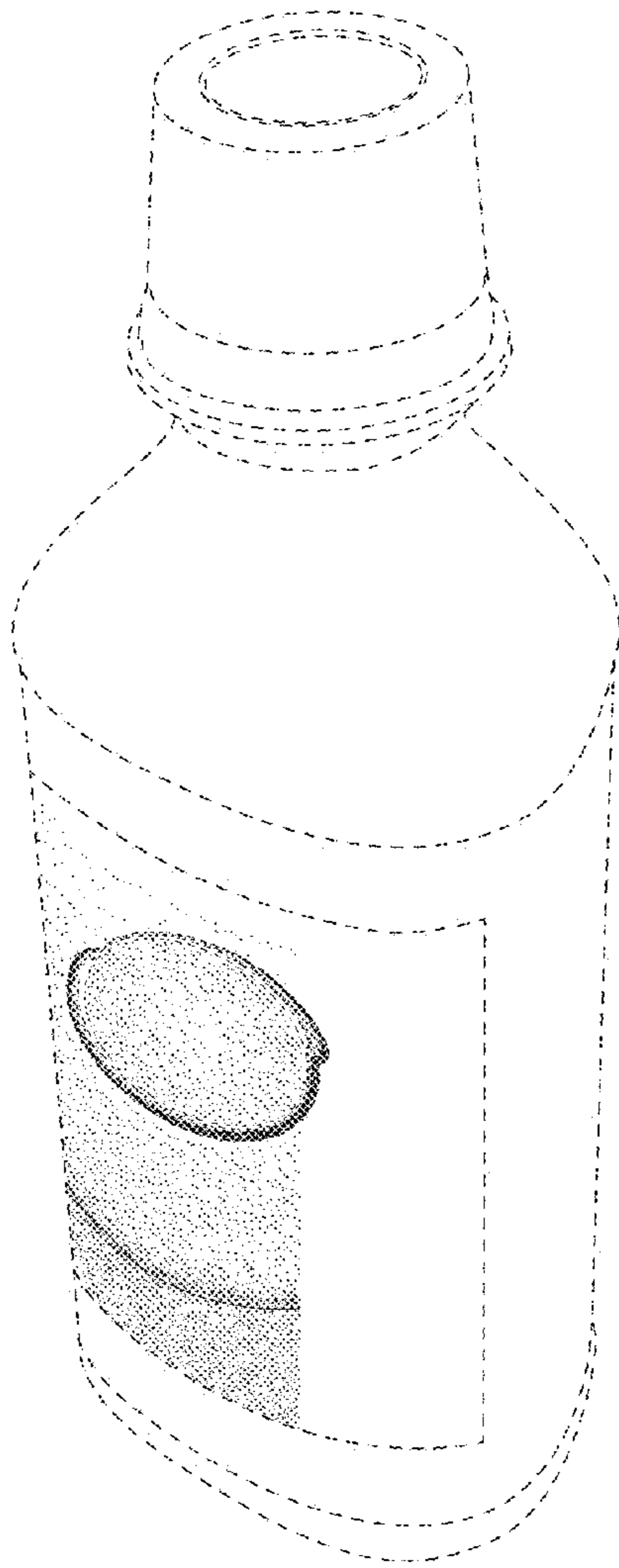

Fig. 22

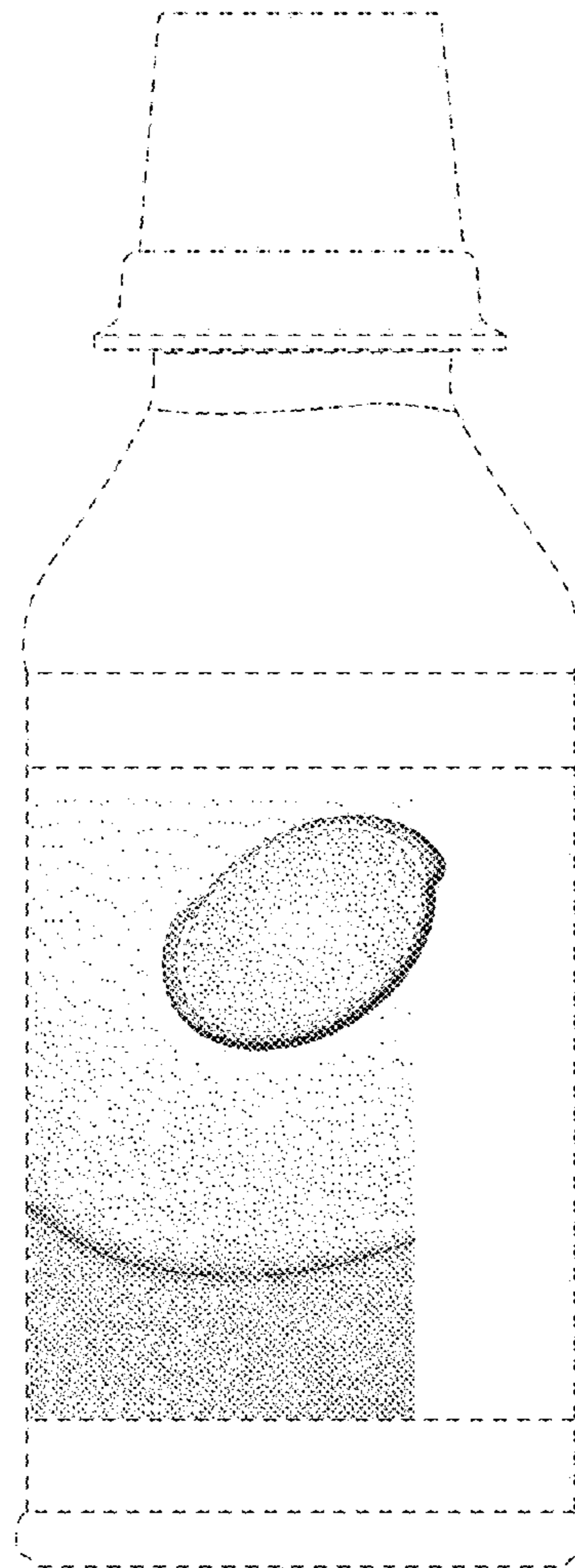

Fig. 23

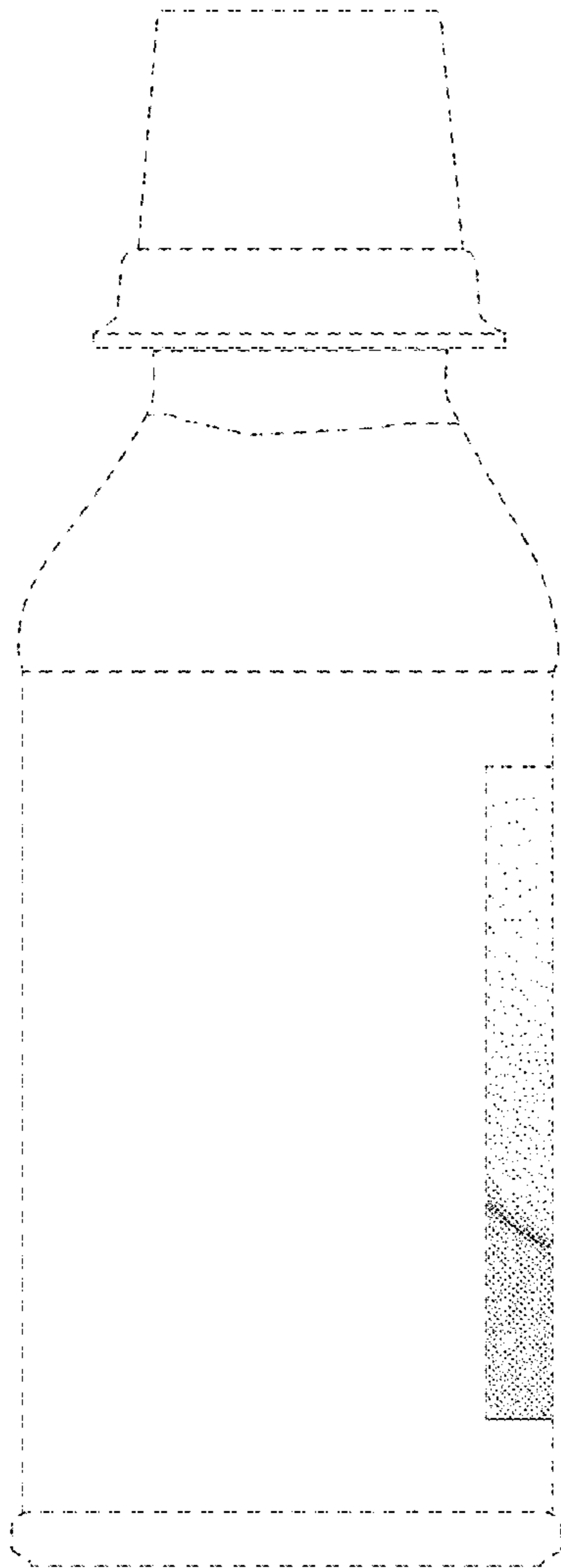

Fig. 24

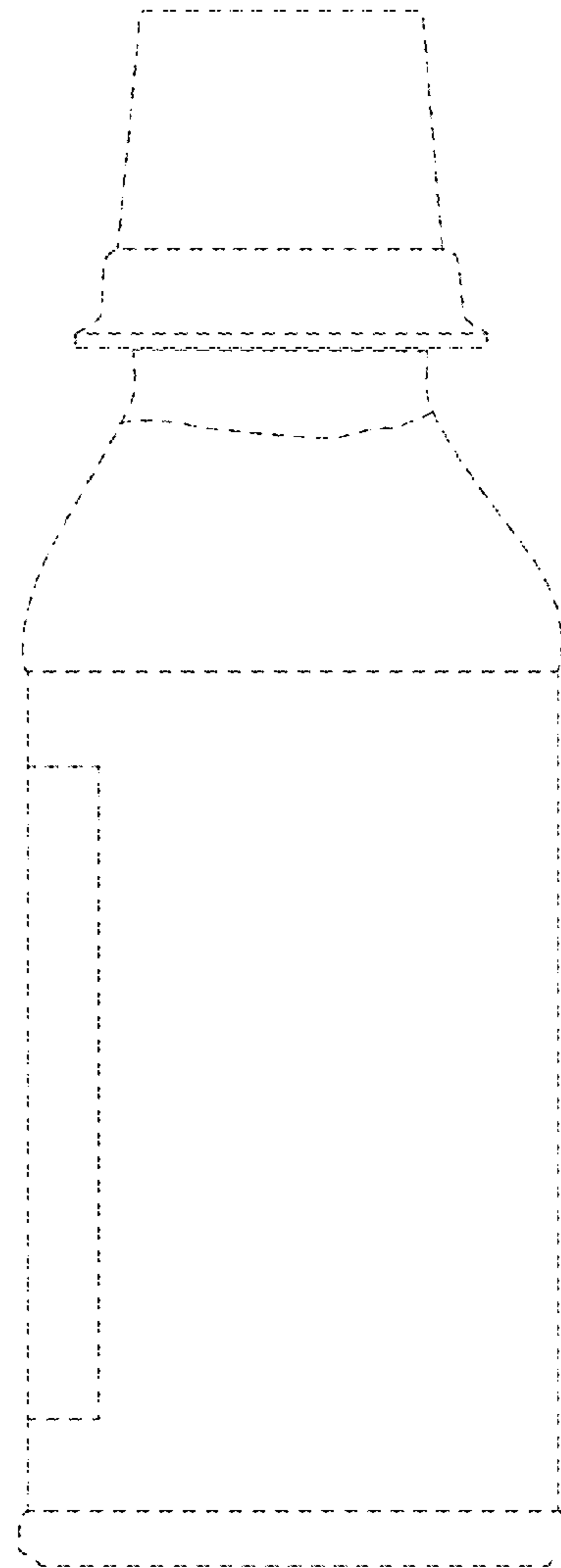

Fig. 25

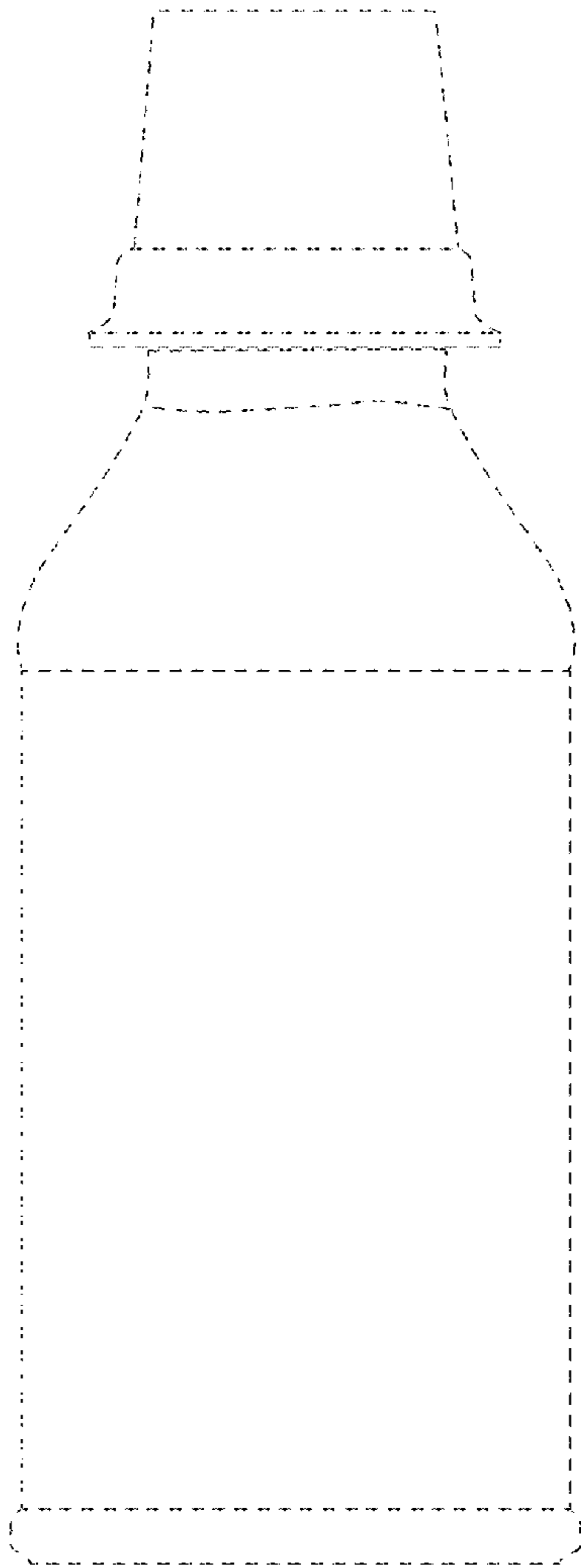

Fig. 26

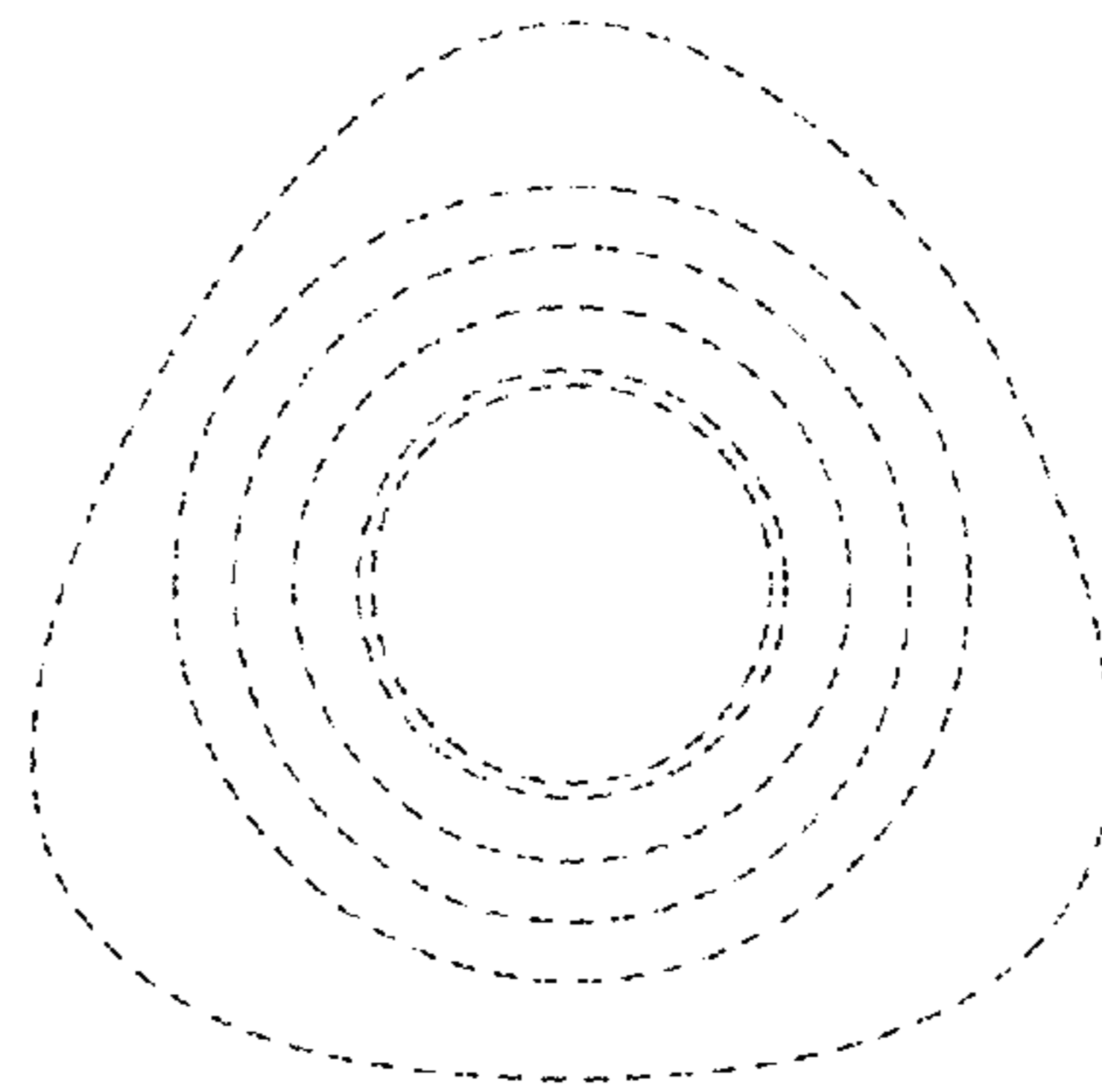

Fig. 27

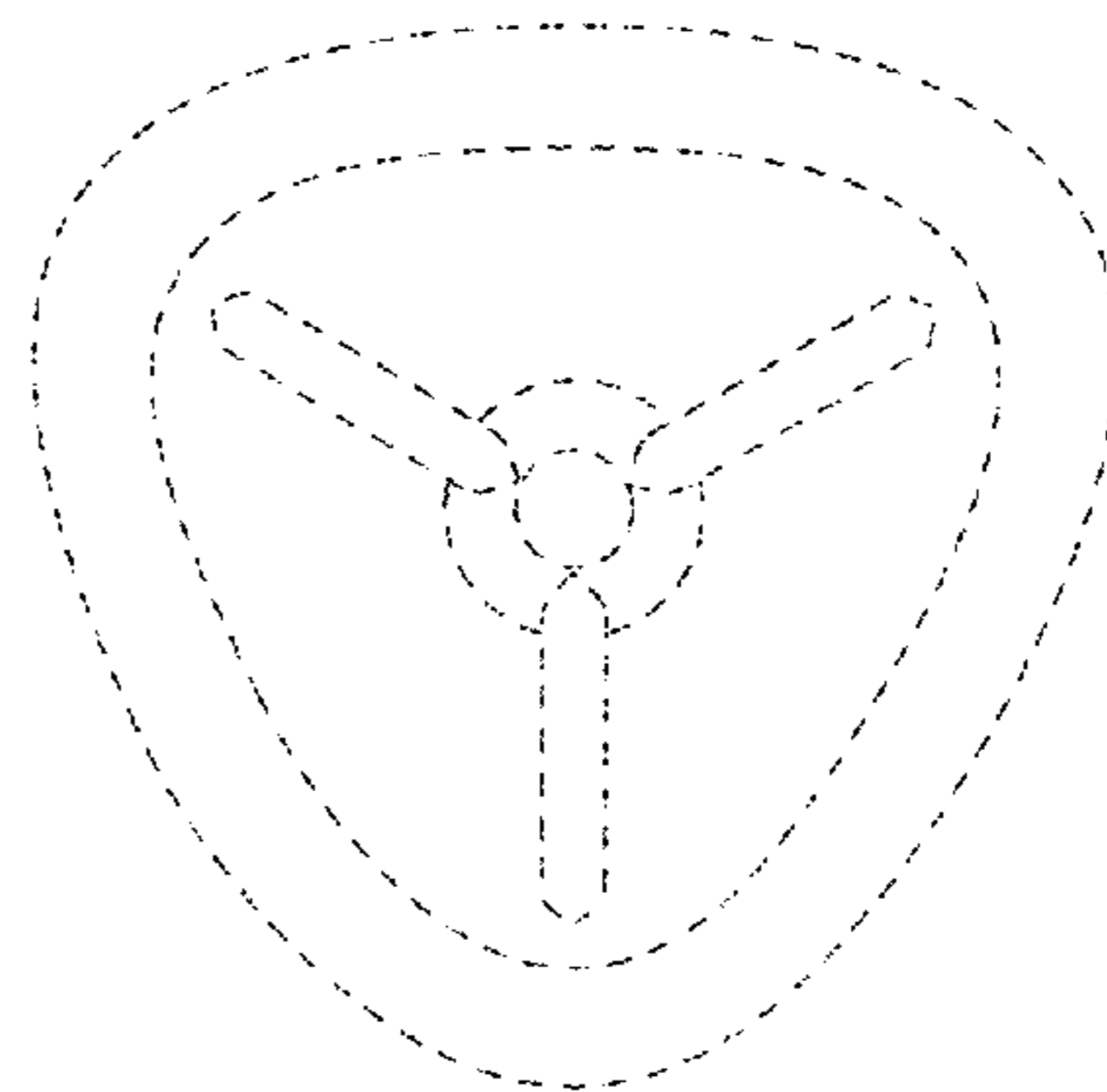

Fig. 28

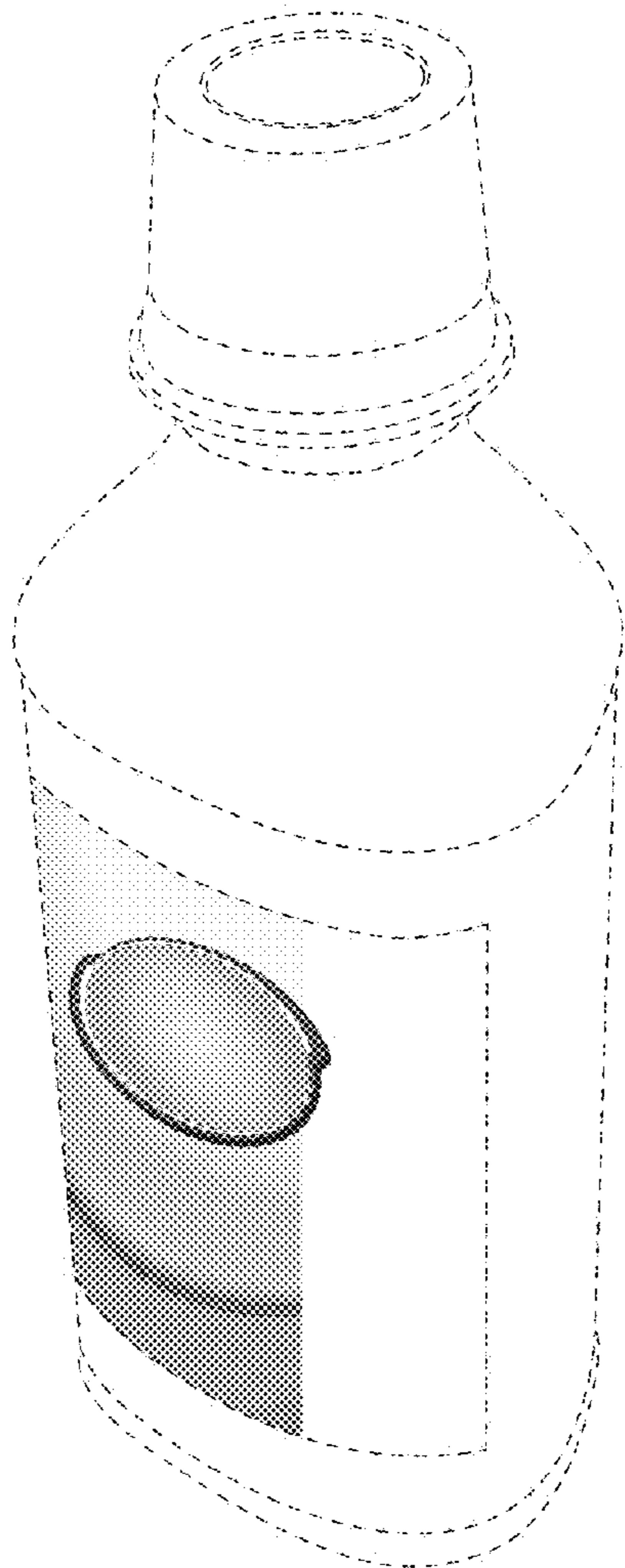

Fig. 29

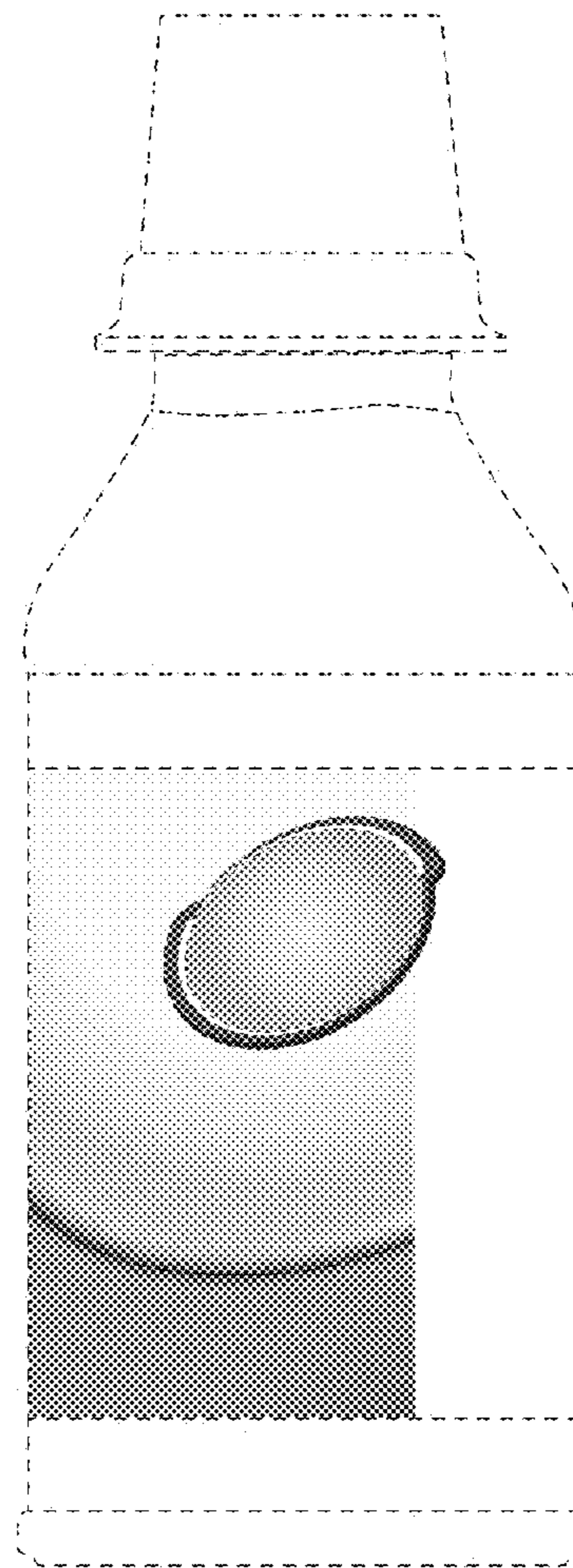

Fig. 30

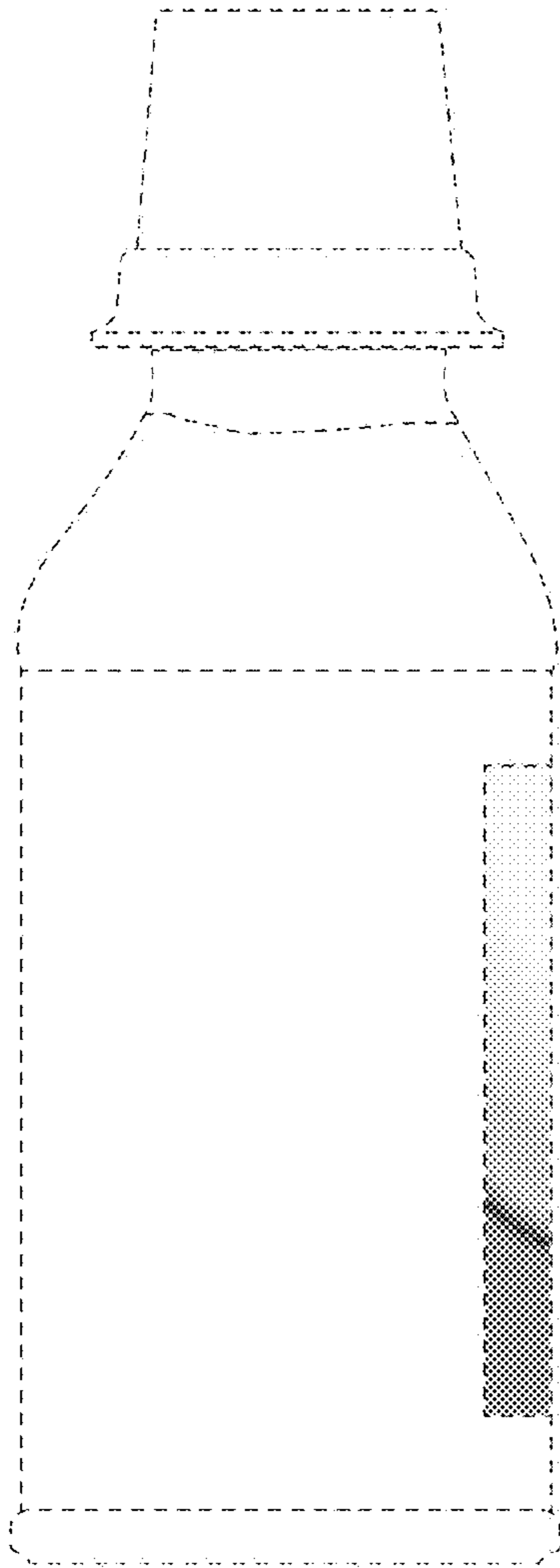

Fig. 31

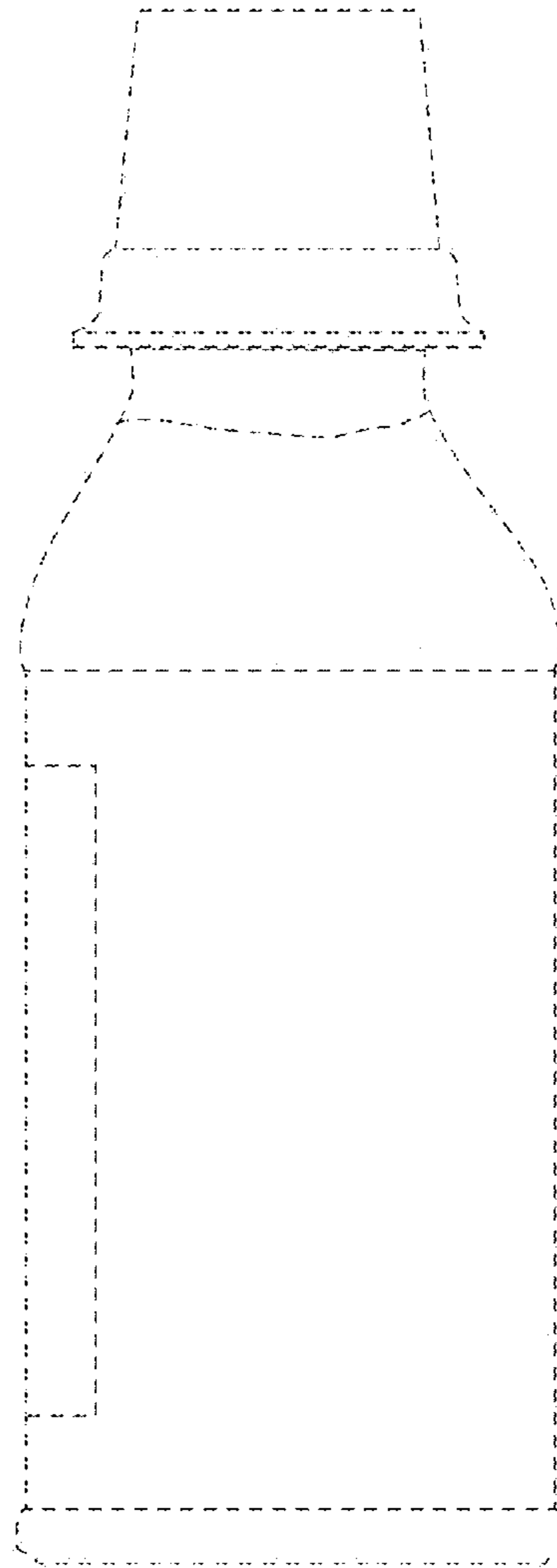

Fig. 32

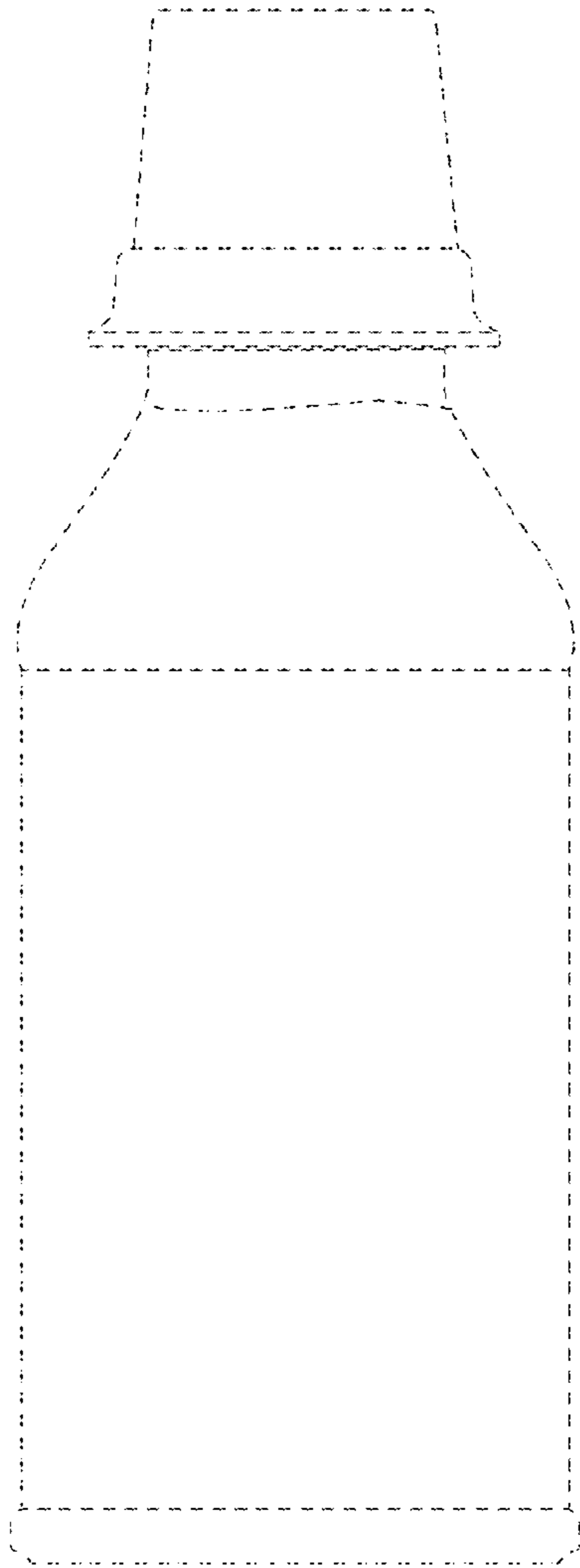

Fig. 33

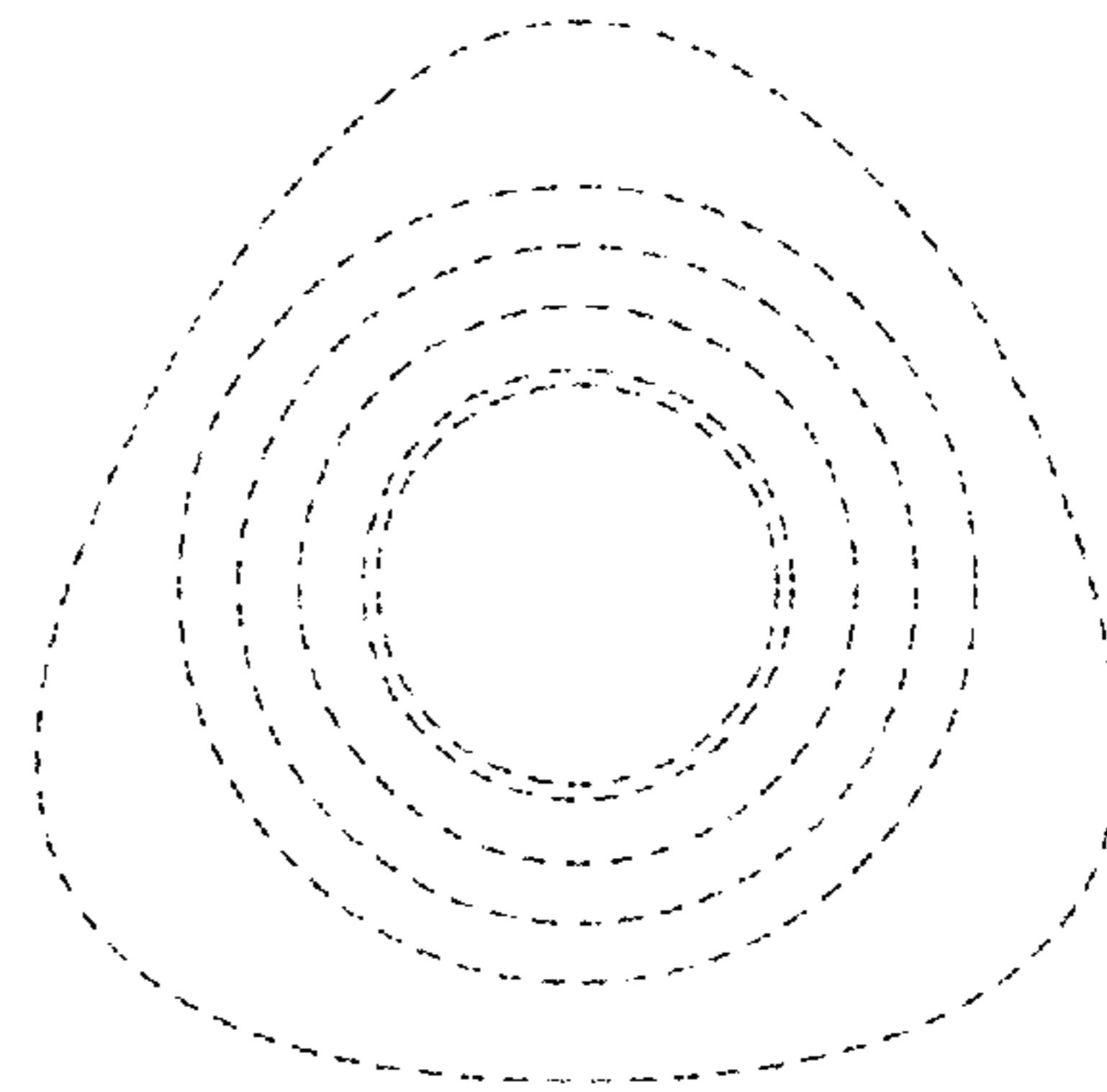

Fig. 34

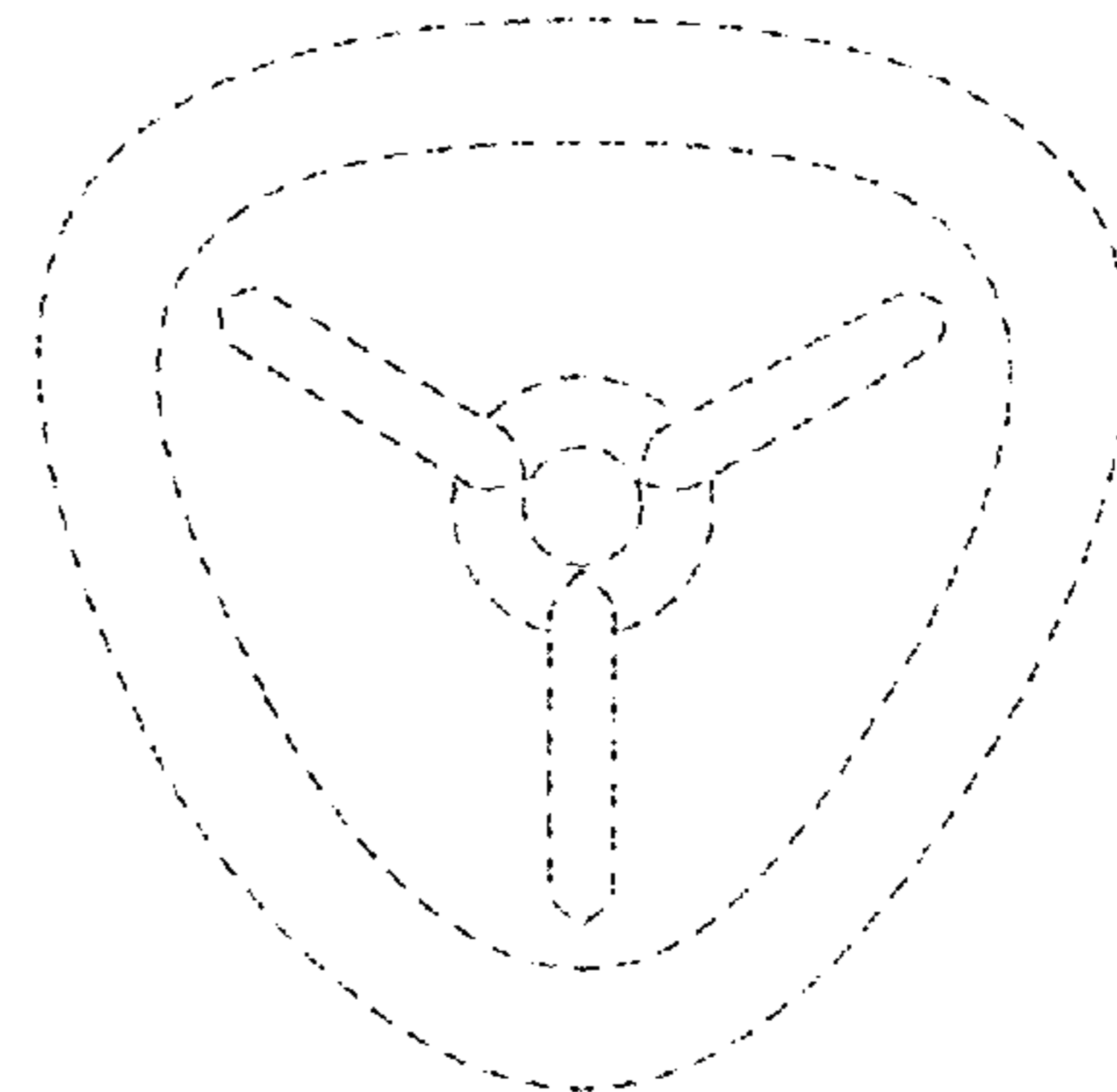

Fig. 35