



US00D747132S

(12) **United States Design Patent**  
**Trefz et al.**

(10) **Patent No.:** **US D747,132 S**  
(45) **Date of Patent:** **\*\* Jan. 12, 2016**

(54) **ATTACHMENT FOR COOKING DEVICE**

(71) Applicant: **The Coleman Company, Inc.**, Wichita, KS (US)

(72) Inventors: **Gabe Trefz**, Wichita, KS (US); **Andrew Worrell**, Lakewood, CO (US)

(73) Assignee: **The Coleman Company, Inc.**, Wichita, KS (US)

(\*\*) Term: **14 Years**

(21) Appl. No.: **29/495,925**

(22) Filed: **Jul. 7, 2014**

(51) **LOC (10) Cl.** ..... **07-02**

(52) **U.S. Cl.**  
USPC ..... **D7/354**

(58) **Field of Classification Search**  
USPC ..... D7/323, 354-363, 391, 393-396, 402, D7/409  
CPC ..... A47G 19/12; A21B 3/13; A47J 27/00; A47J 27/002; A47J 27/08; A47J 27/21; A47J 27/58; A47J 36/025; A47J 36/06; A47J 36/12; A47J 37/00; A47J 37/10; A47J 37/101; A47J 37/103; A47J 37/12; A47J 37/1204; A47J 45/061; A47J 45/071; A47J 45/08; H05B 6/12

See application file for complete search history.

(56) **References Cited**

**U.S. PATENT DOCUMENTS**

1,413,063	A *	4/1922	Sailer	.....	A21B 3/13 126/390.1
D230,459	S *	2/1974	Gulotta	.....	D7/360
D392,152	S *	3/1998	Rae	.....	D7/354
D392,840	S *	3/1998	Rae	.....	D7/354

D552,925	S *	10/2007	Kloppsteck	.....	D7/361
D562,060	S *	2/2008	Kloppsteck	.....	D7/361
D562,621	S *	2/2008	Kloppsteck	.....	D7/360
D662,356	S *	6/2012	Moulin	.....	D7/354
D662,774	S *	7/2012	Moulin	.....	D7/354
D663,160	S *	7/2012	Moulin	.....	D7/354
D663,161	S *	7/2012	Moulin	.....	D7/354
D664,000	S *	7/2012	Moulin	.....	D7/354
D669,730	S *	10/2012	Mandil	.....	D7/354

\* cited by examiner

*Primary Examiner* — Ricky Pham

(57) **CLAIM**

The ornamental design for an attachment for cooking device, as shown and described.

**DESCRIPTION**

FIG. 1 is a front side perspective view of a first embodiment of the attachment for cooking device;  
 FIG. 2 is a front elevation view of the embodiment shown in FIG. 1;  
 FIG. 3 is a rear elevation view thereof;  
 FIG. 4 is a left side elevation view thereof;  
 FIG. 5 is a right side elevation view thereof;  
 FIG. 6 is a bottom plan view thereof;  
 FIG. 7 is a front side perspective view of a second embodiment of the attachment for cooking device;  
 FIG. 8 is a front elevation view of the embodiment shown in FIG. 7;  
 FIG. 9 is a rear elevation view thereof;  
 FIG. 10 is a left side elevation view thereof;  
 FIG. 11 is a right side elevation view thereof;  
 FIG. 12 is a top plan view thereof; and,  
 FIG. 13 is a bottom plan view thereof.  
 The broken line showing is for illustrative purposes only and forms no part of the claimed design.

**1 Claim, 4 Drawing Sheets**

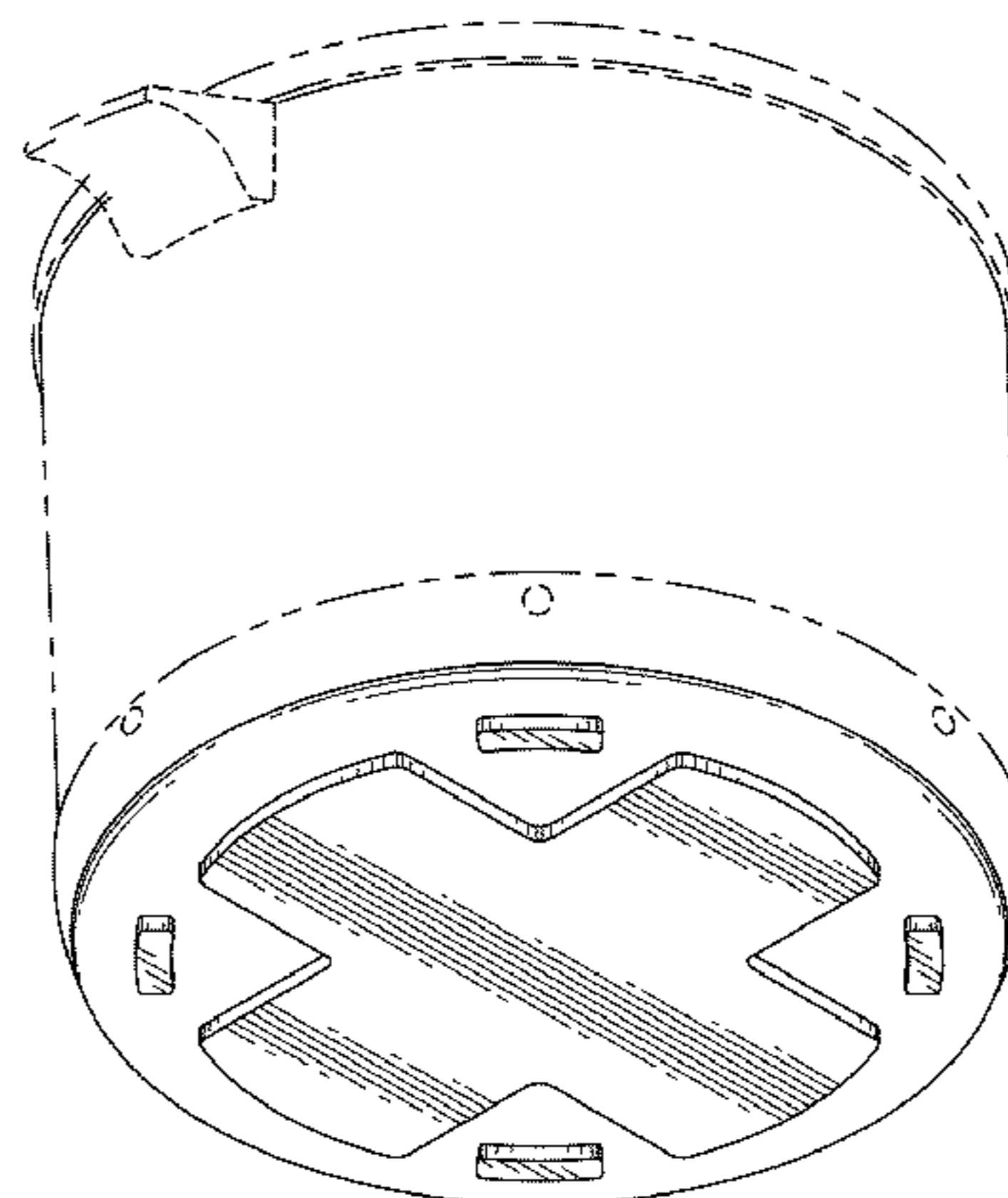
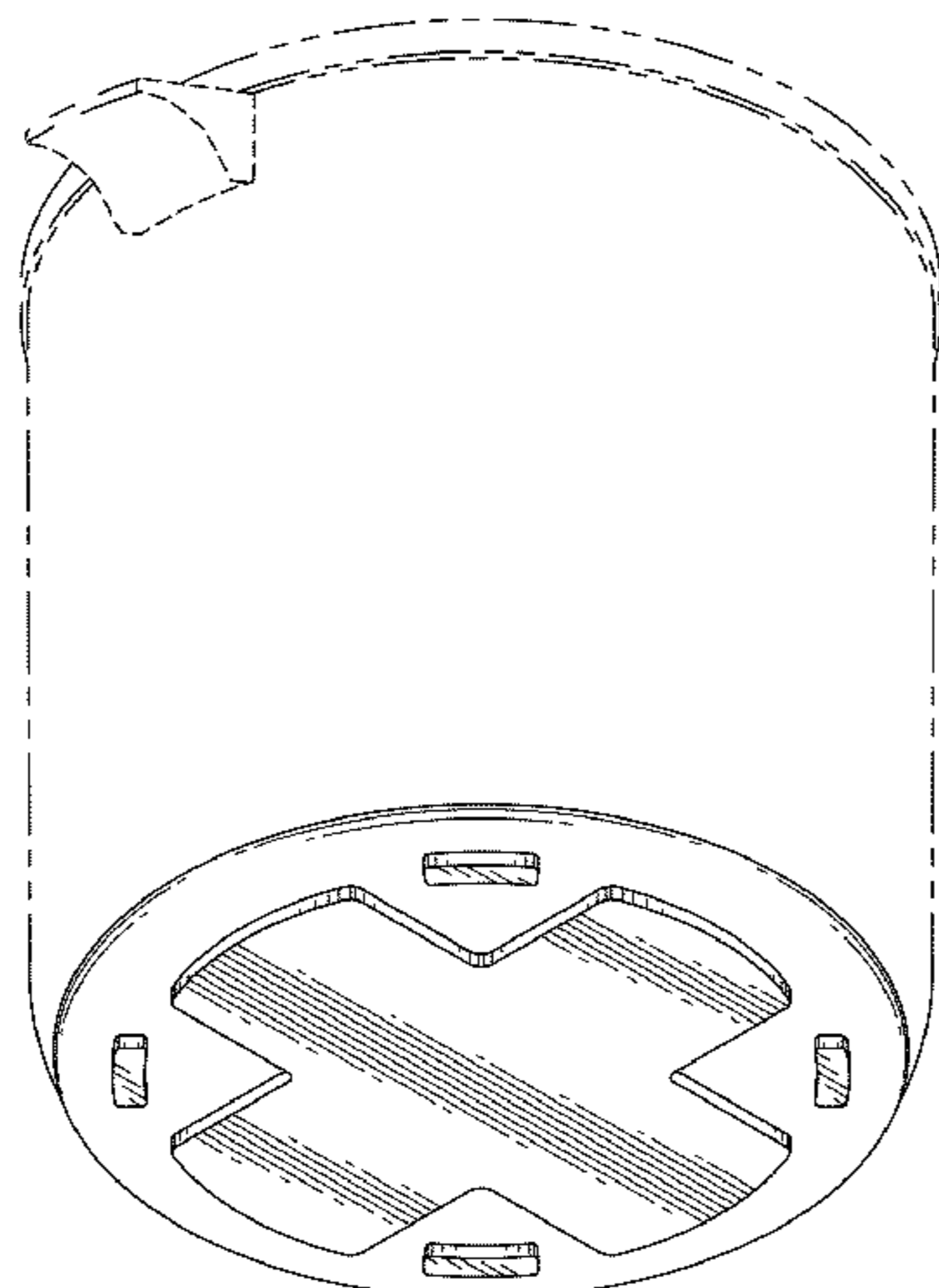

FIG. 1

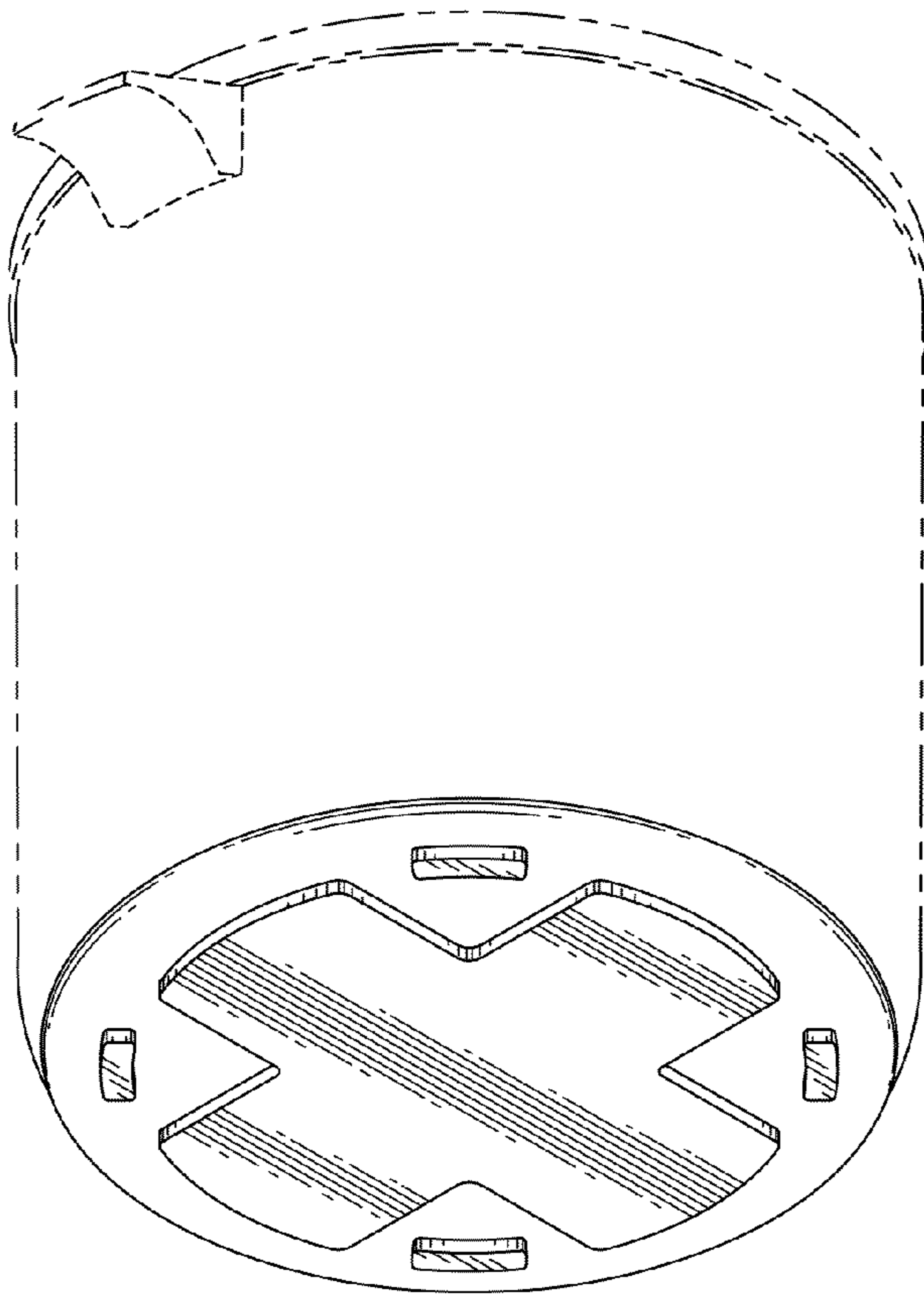

FIG. 2

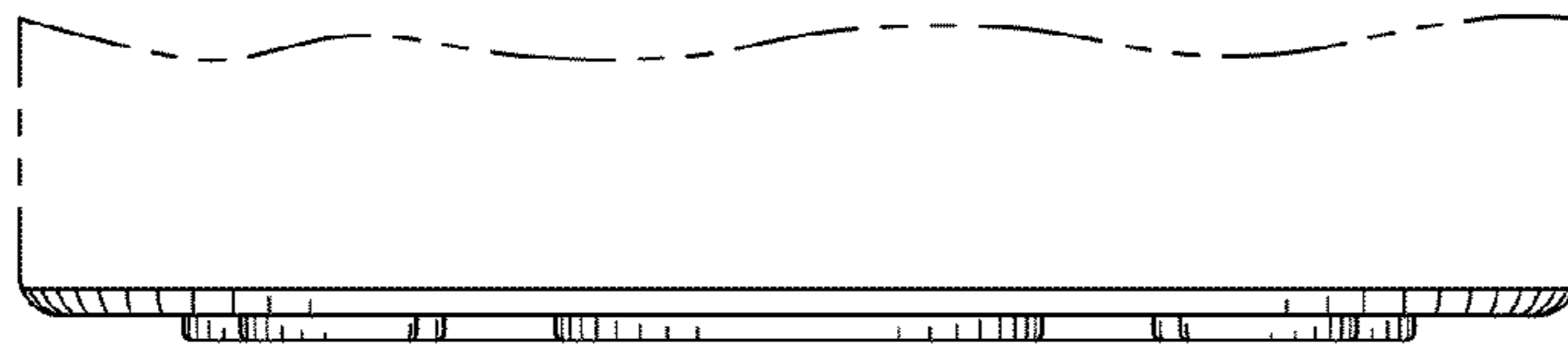

FIG. 3

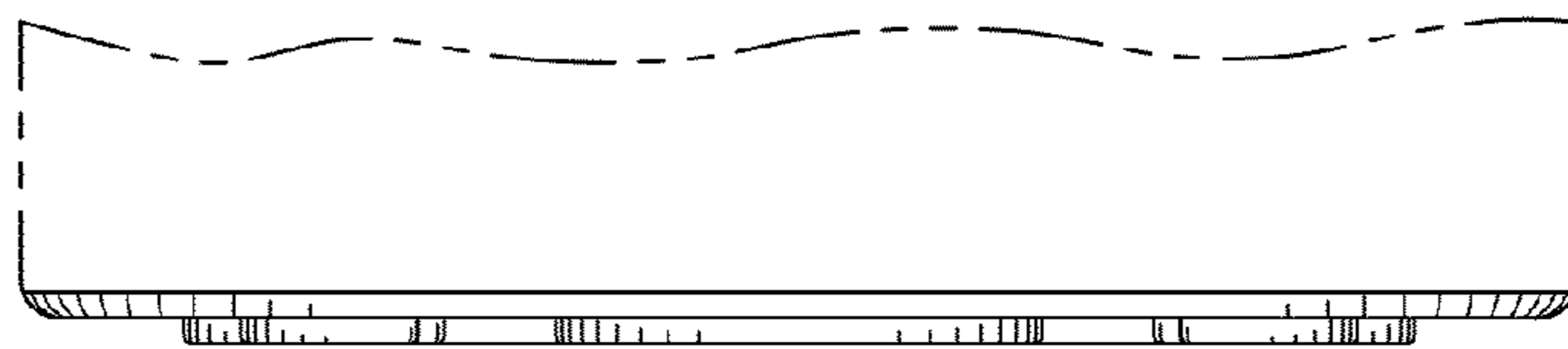

FIG. 4

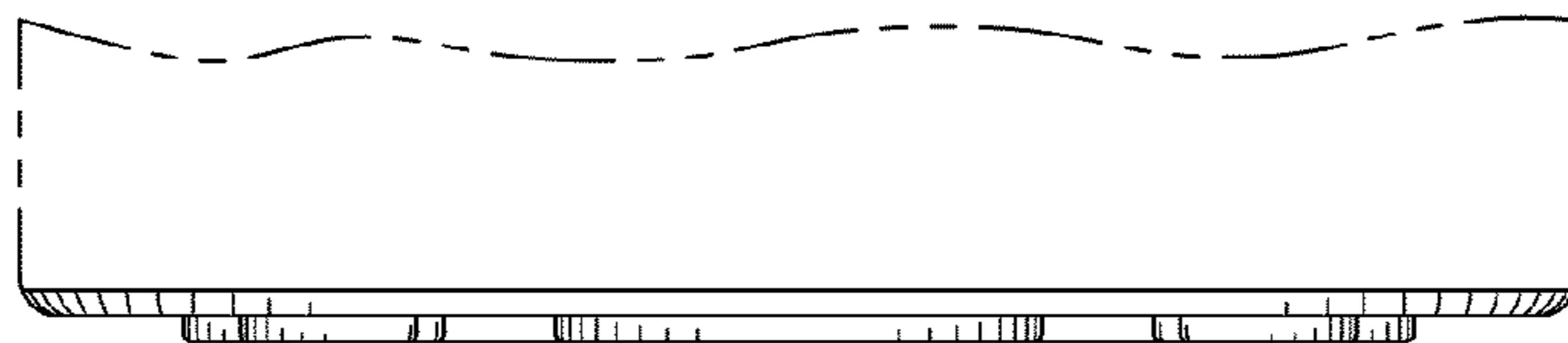

FIG. 5

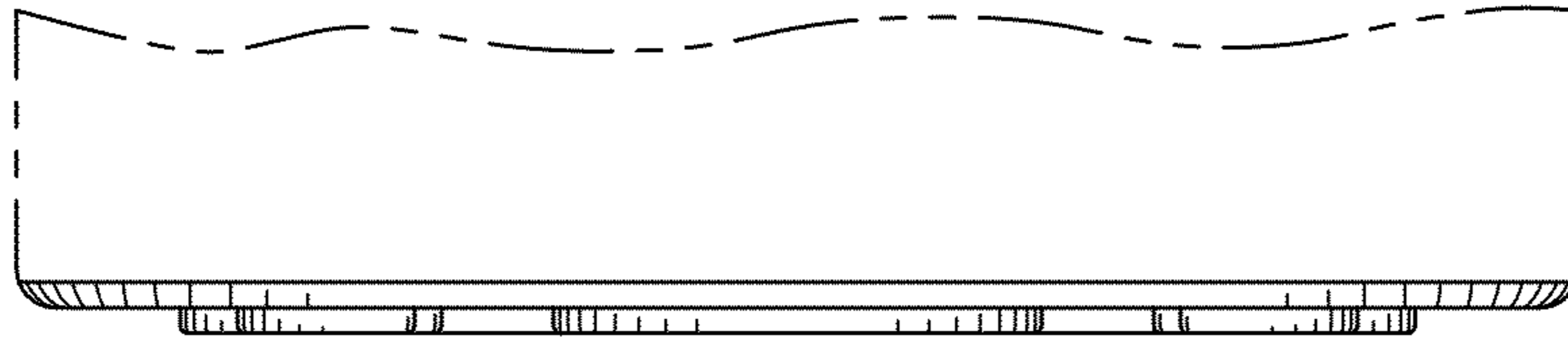

FIG. 6

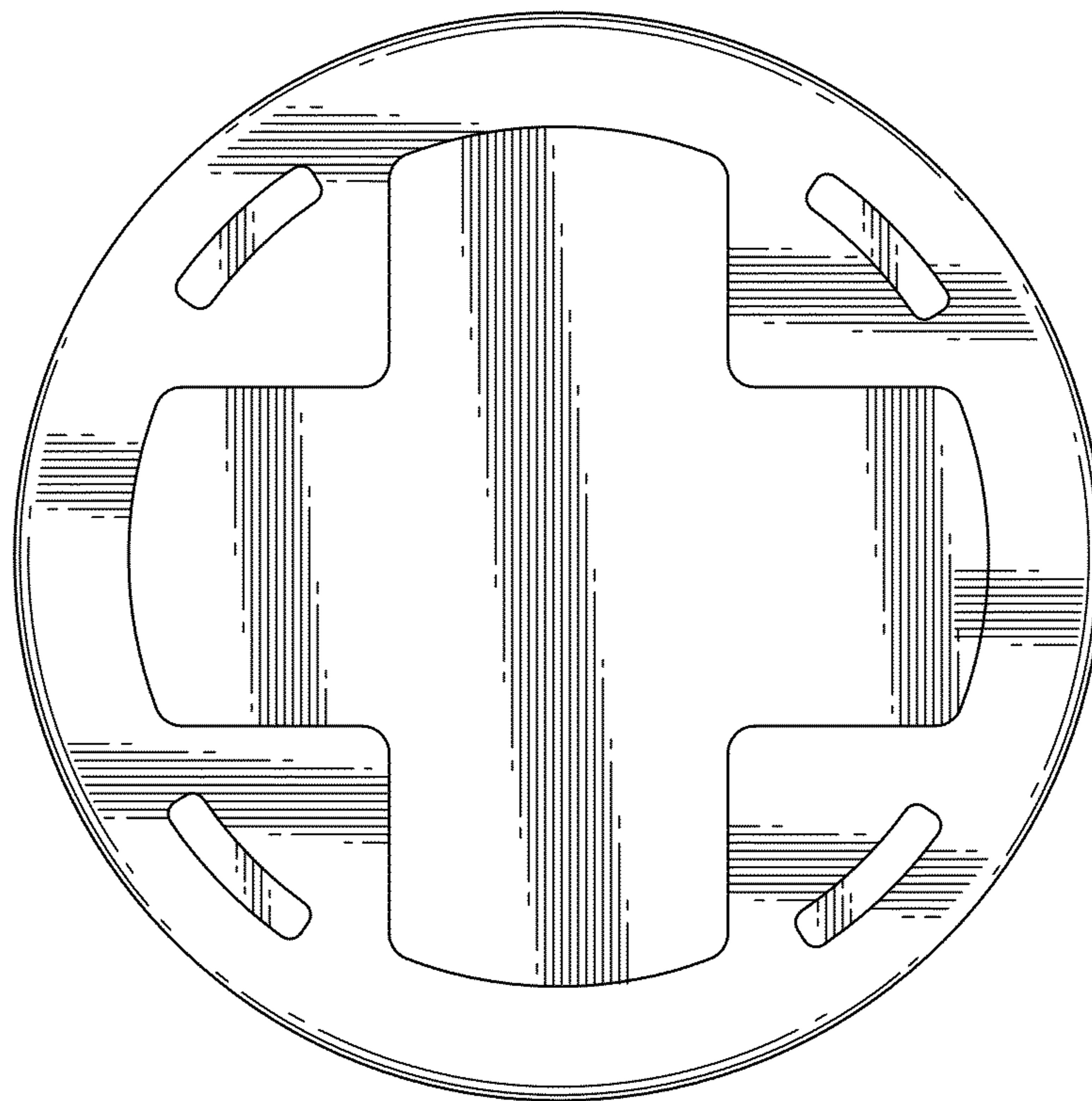

FIG. 7

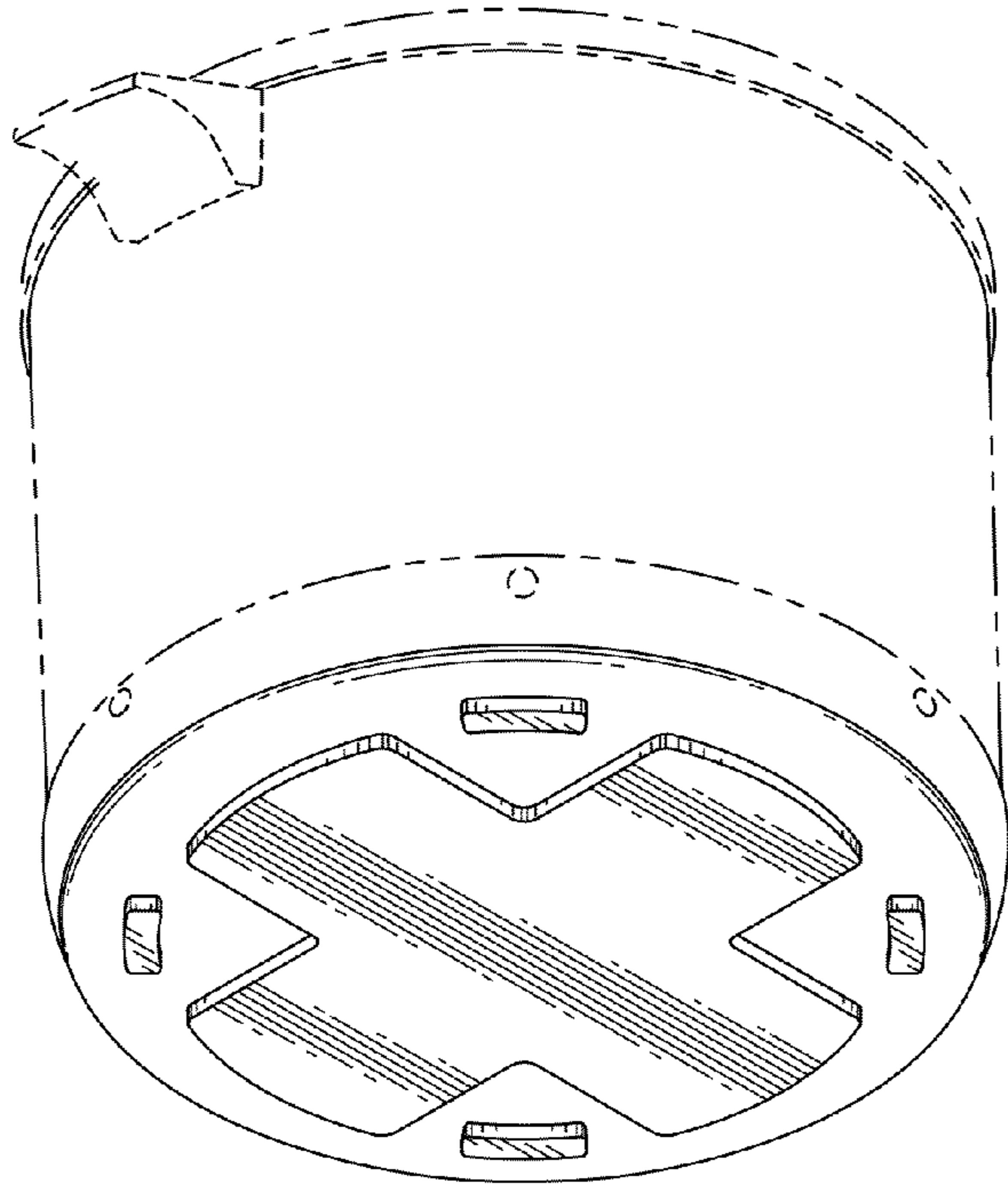

FIG. 8

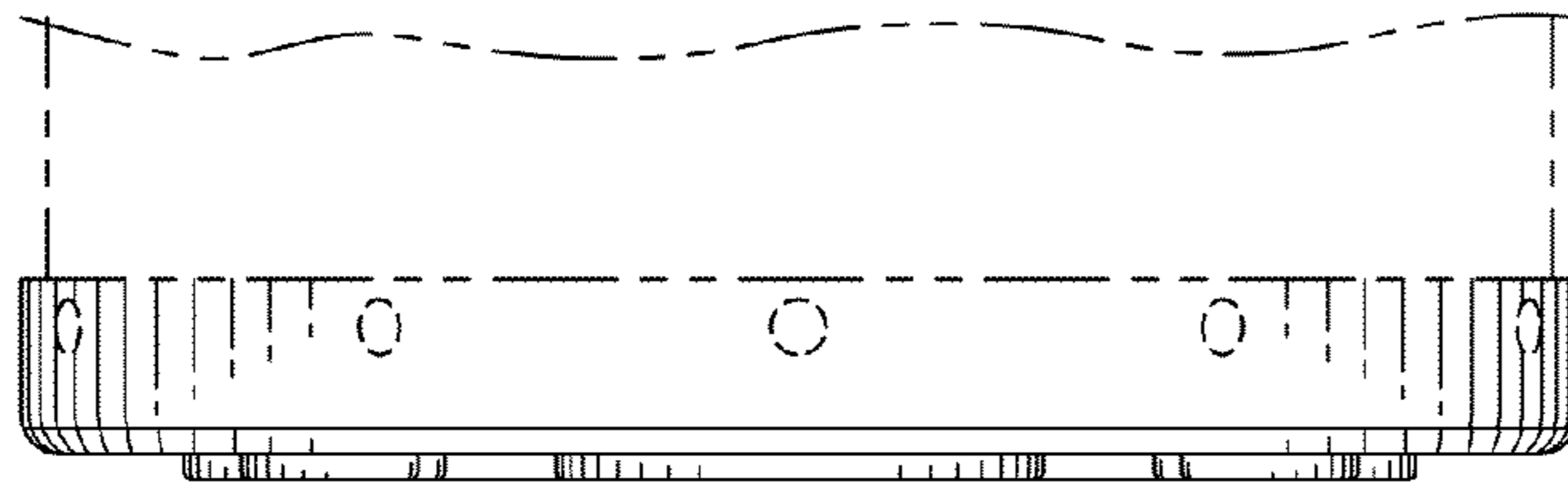

FIG. 9

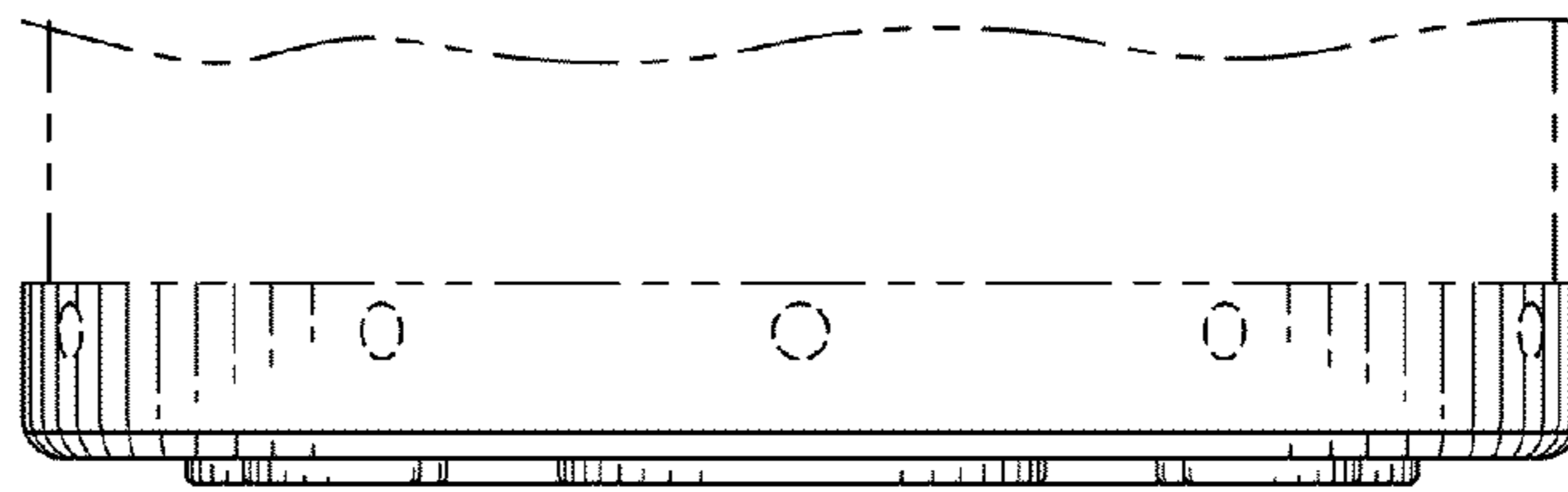

FIG. 10

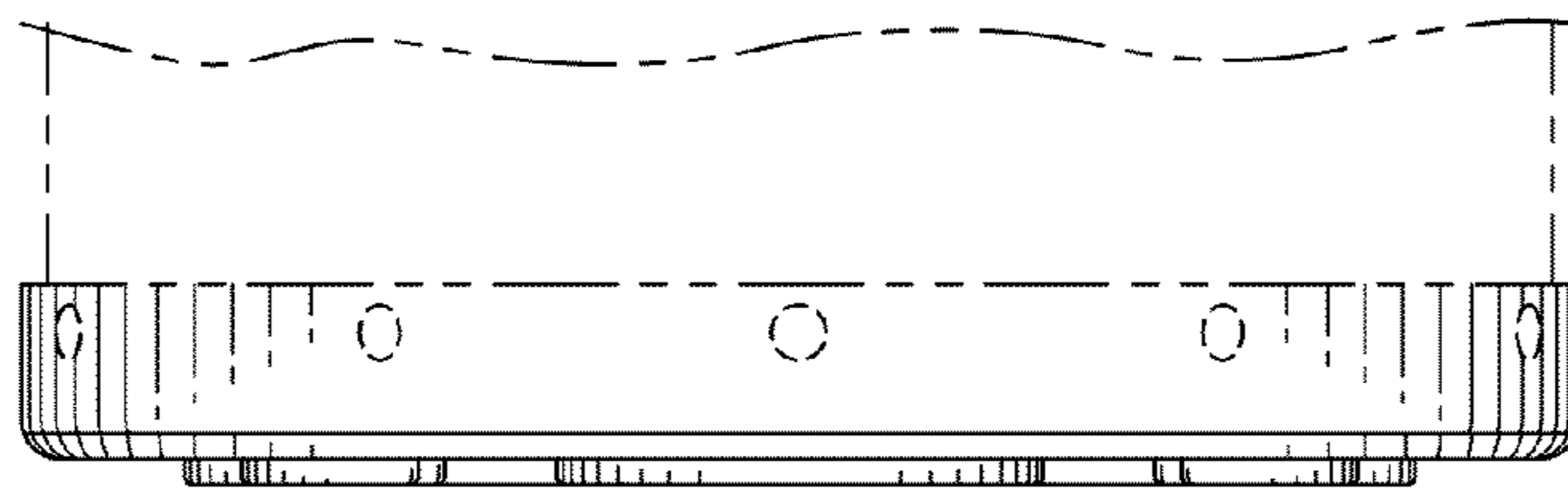

FIG. 11

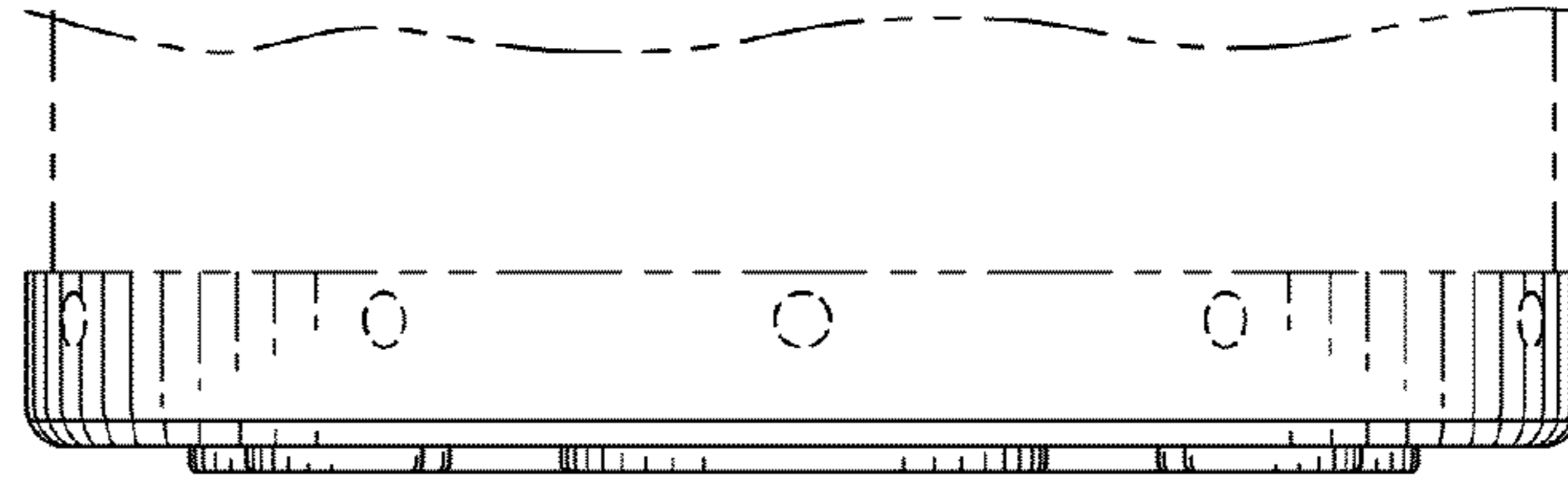

FIG. 12

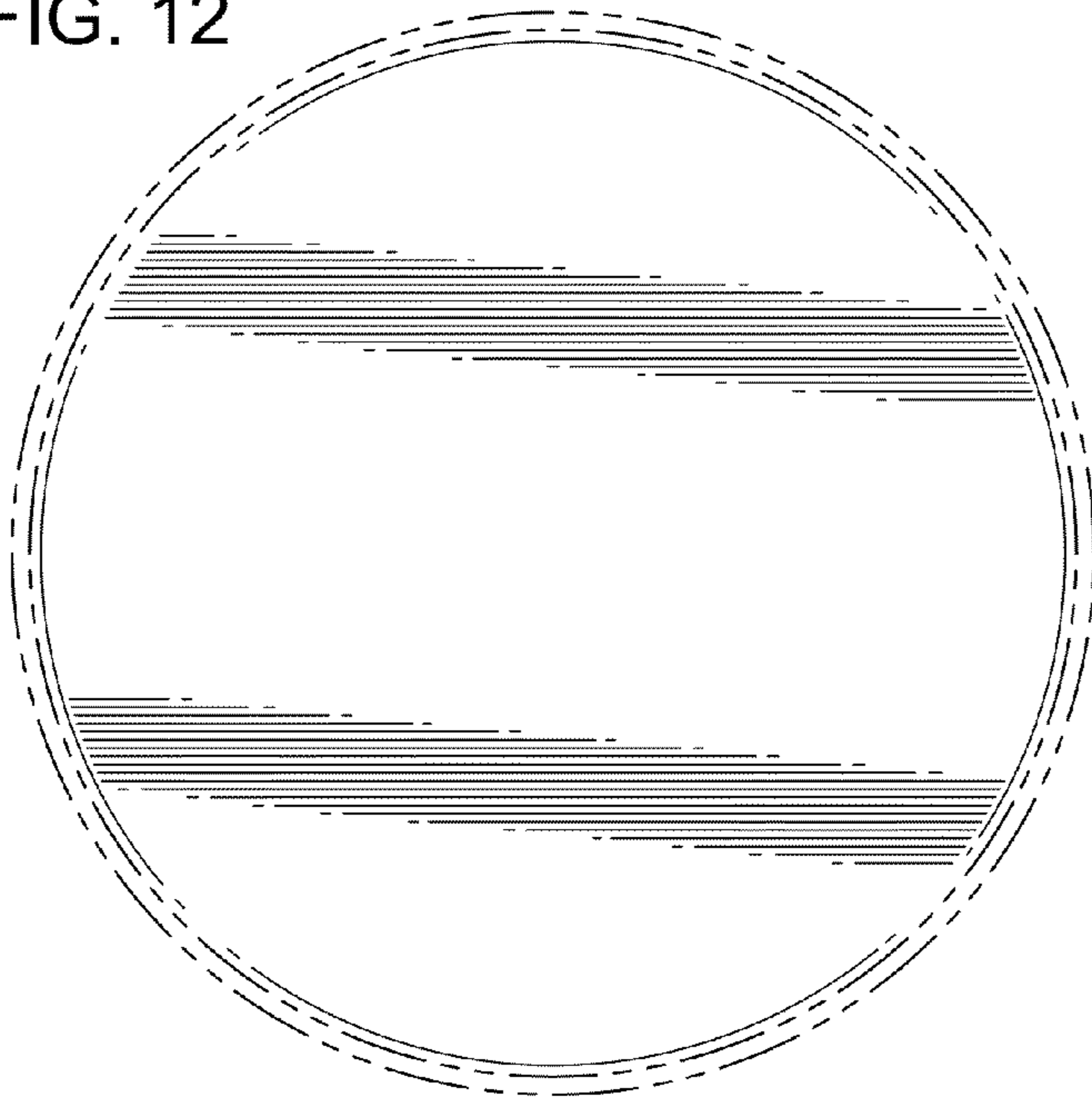

FIG. 13

