



US00D747098S

(12) **United States Design Patent**  
**Collins et al.**

(10) **Patent No.:** **US D747,098 S**  
(45) **Date of Patent:** **\*\* Jan. 12, 2016**

- (54) **SPORTS BAG**
- (71) Applicant: **GRIT INC.**, Tottenham (CA)
- (72) Inventors: **Gregory James Collins**, Loretto (CA);  
**Matthew Gordon Thomas Hughson**,  
Vaughn (CA); **Erin Dawn Dobo**, Barrie  
(CA)
- (73) Assignee: **GRIT, INC.**, Tottenham, Ontario (CA)
- (\*\*) Term: **14 Years**
- (21) Appl. No.: **29/490,976**
- (22) Filed: **May 15, 2014**

D374,773 S 10/1996 Domotor  
5,797,612 A 8/1998 Buccioni  
5,918,710 A 7/1999 Sher

(Continued)

FOREIGN PATENT DOCUMENTS

CA 1226567 9/1987  
CA 1319939 7/1993

(Continued)

*Primary Examiner* — Holly Baynham  
(74) *Attorney, Agent, or Firm* — Wood, Herron & Evans,  
LLP

(57) **CLAIM**

The ornamental design for a sports bag, as shown and described.

**DESCRIPTION**

FIG. 1 is a front view of the sports bag in accordance with the present design;  
FIG. 2 is a right side view of the sports bag of FIG. 1;  
FIG. 3 is a left side view of the sports bag of FIG. 1;  
FIG. 4 is a rear view of the sports bag of FIG. 1;  
FIG. 5 is a top view of the sports bag of FIG. 1;  
FIG. 6 is a bottom view of the sports bag of FIG. 1;  
FIG. 7 is a front perspective view of the sports bag of FIG. 1;  
FIG. 8 is a rear perspective view of the sports bag of FIG. 1;  
FIG. 9 is a front perspective view of the sports bag of FIG. 1 with the front zippered door in an open position and with the internal shelving removed; and,  
FIG. 10 is a front perspective view of the sports bag of FIG. 1 with the front zippered door in an open position and showing the internal shelving.  
The broken lines illustrate portions of the sports bag which form no part of the claimed design.

(30) **Foreign Application Priority Data**

Nov. 15, 2013 (CA) ..... 153775

(51) **LOC (10) Cl.** ..... **03-01**

(52) **U.S. Cl.**  
USPC ..... **D3/254; D3/279**

(58) **Field of Classification Search**  
USPC ..... **D3/254, 272-273, 279**  
CPC ..... **A45C 5/00; A45C 13/36; A45C 5/14**  
See application file for complete search history.

(56) **References Cited**

U.S. PATENT DOCUMENTS

2,115,308 A 4/1938 Koch  
2,710,084 A 6/1955 Braverman  
2,718,943 A 9/1955 Braverman  
5,118,130 A 6/1992 Kaltz  
5,139,308 A 8/1992 Ziman  
5,439,241 A 8/1995 Nelson  
5,476,184 A 12/1995 Hill  
5,499,760 A 3/1996 Pielocik

**1 Claim, 10 Drawing Sheets**

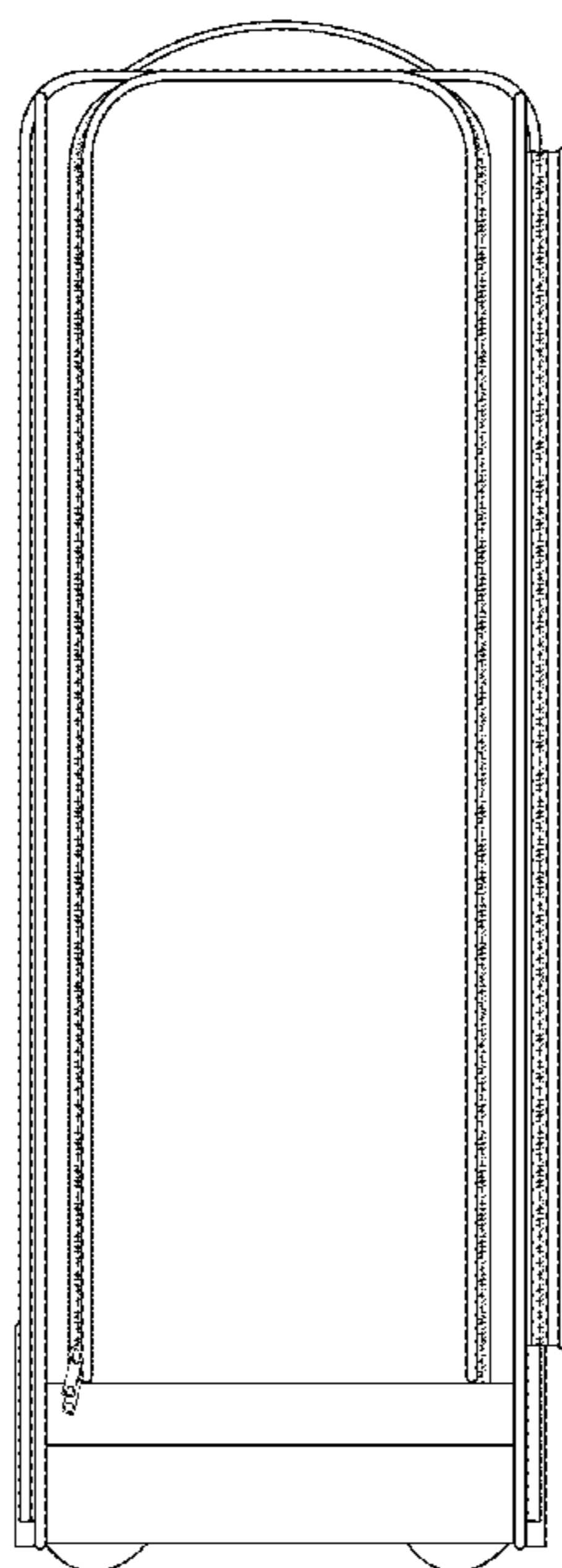

(56)

**References Cited**

U.S. PATENT DOCUMENTS

6,062,357	A	5/2000	Bogert	
6,264,078	B1	7/2001	Bilang	
D459,883	S	7/2002	Worrell et al.	
6,443,274	B1	9/2002	Klamm	
D471,013	S	3/2003	Peterson	
D476,153	S *	6/2003	Sadr .....	D3/279
6,763,940	B1	7/2004	Lai	
6,874,797	B2	4/2005	Gardenour	
6,932,427	B2	8/2005	Tamura	
6,997,507	B2	2/2006	Rhee	
7,757,912	B1	7/2010	Fabro	
D640,054	S	6/2011	Custer	
D662,319	S	6/2012	Collins et al.	
D664,765	S *	8/2012	Saia .....	D3/279
D666,812	S *	9/2012	Coffing .....	D3/254
D666,816	S *	9/2012	Weber .....	D3/279
D683,539	S *	6/2013	Jobert .....	D3/279

8,453,812	B2	6/2013	Xiao
2004/0065518	A1	4/2004	Hoberman
2005/0034948	A1	2/2005	Tiramani
2008/0023282	A1	1/2008	Duncan
2009/0183961	A1	7/2009	Whalen et al.
2009/0255770	A1	10/2009	Slater
2011/0162931	A1	7/2011	Collins et al.

FOREIGN PATENT DOCUMENTS

CA	1321568	8/1993
CA	2145612	8/1999
CA	2327764	6/2002
CA	117465 S	1/2008
CA	2581636	9/2008
CN	201164134	12/2008
WO	2008021793	2/2008
WO	2011082468	7/2011

\* cited by examiner

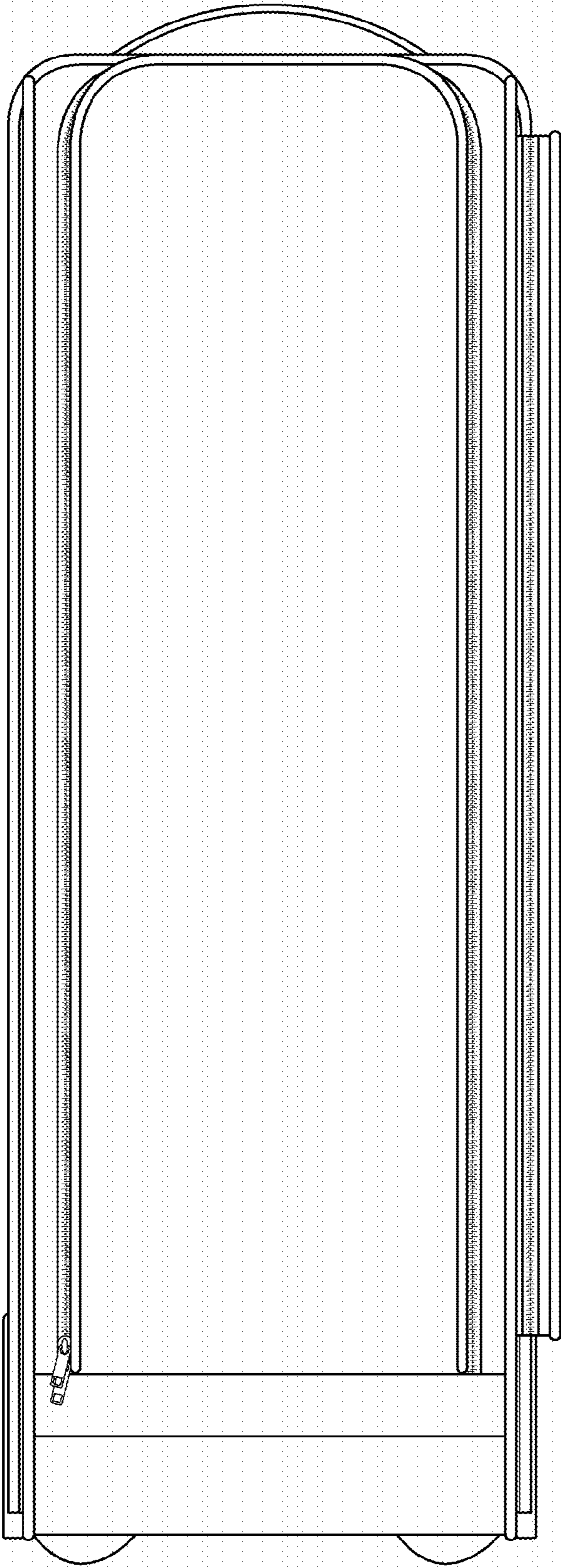

FIG. 1

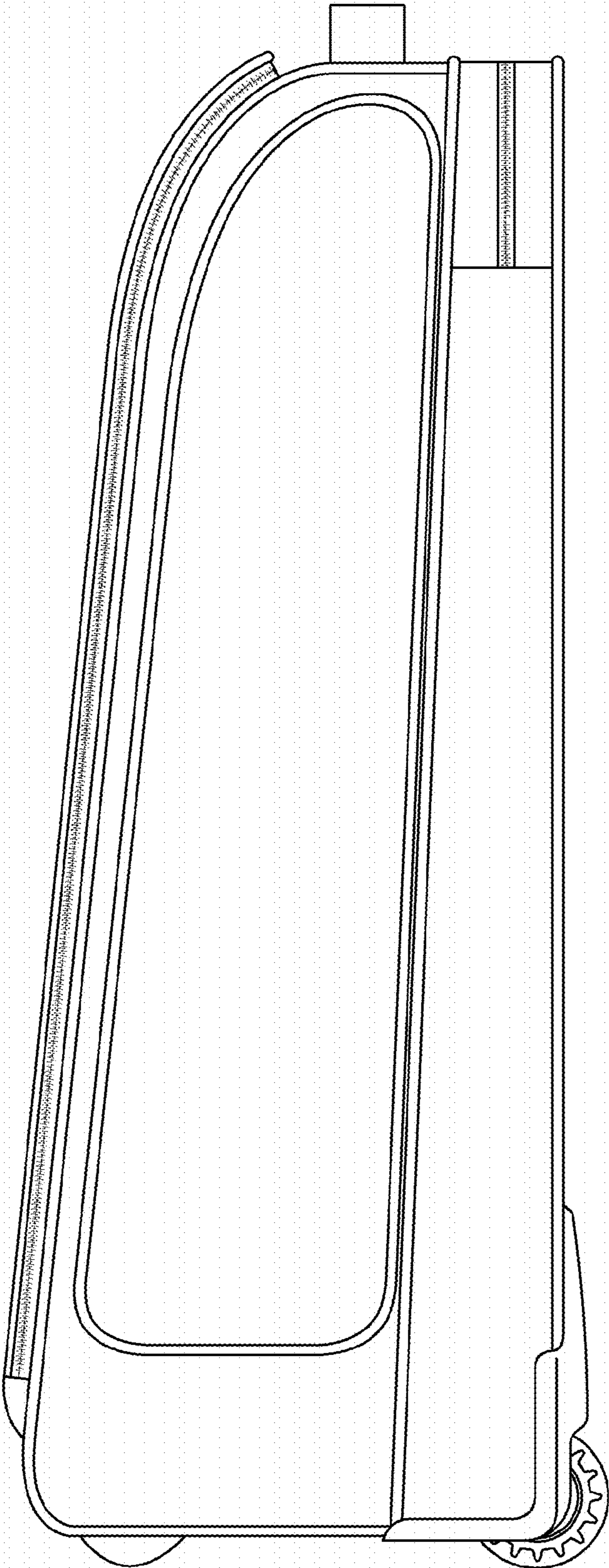

FIG. 2

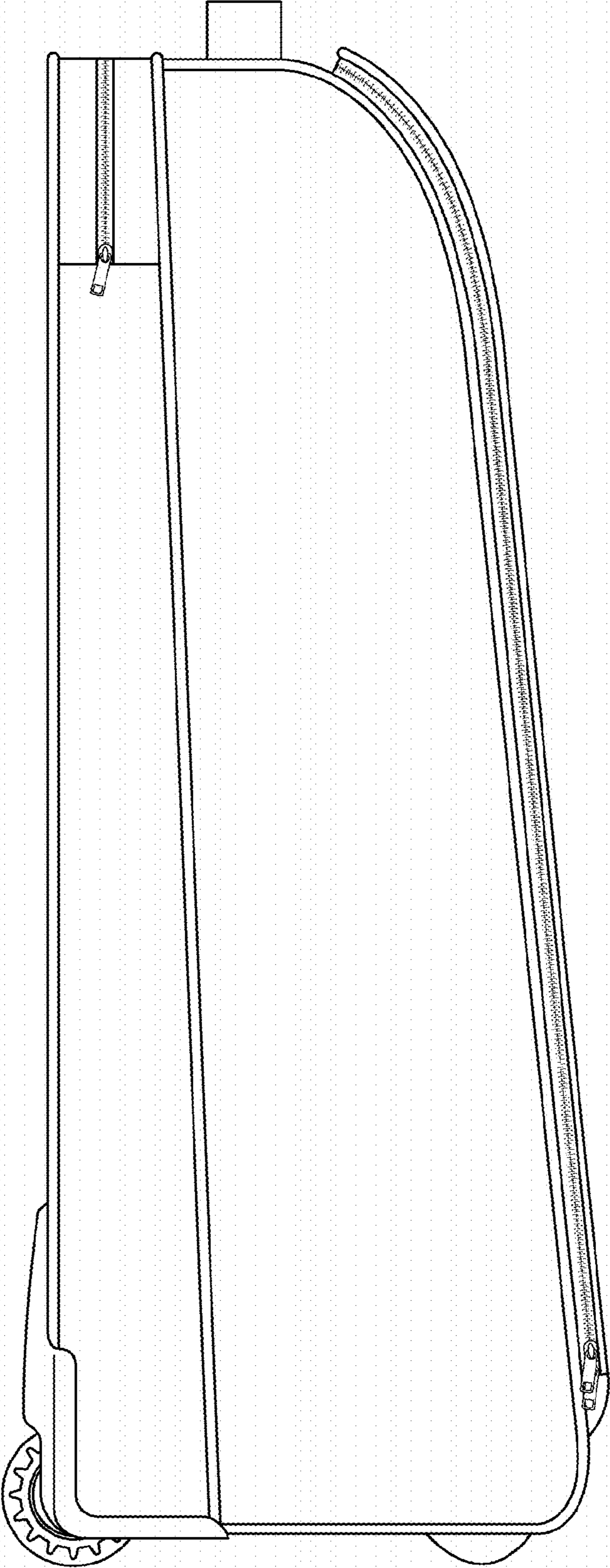

FIG. 3

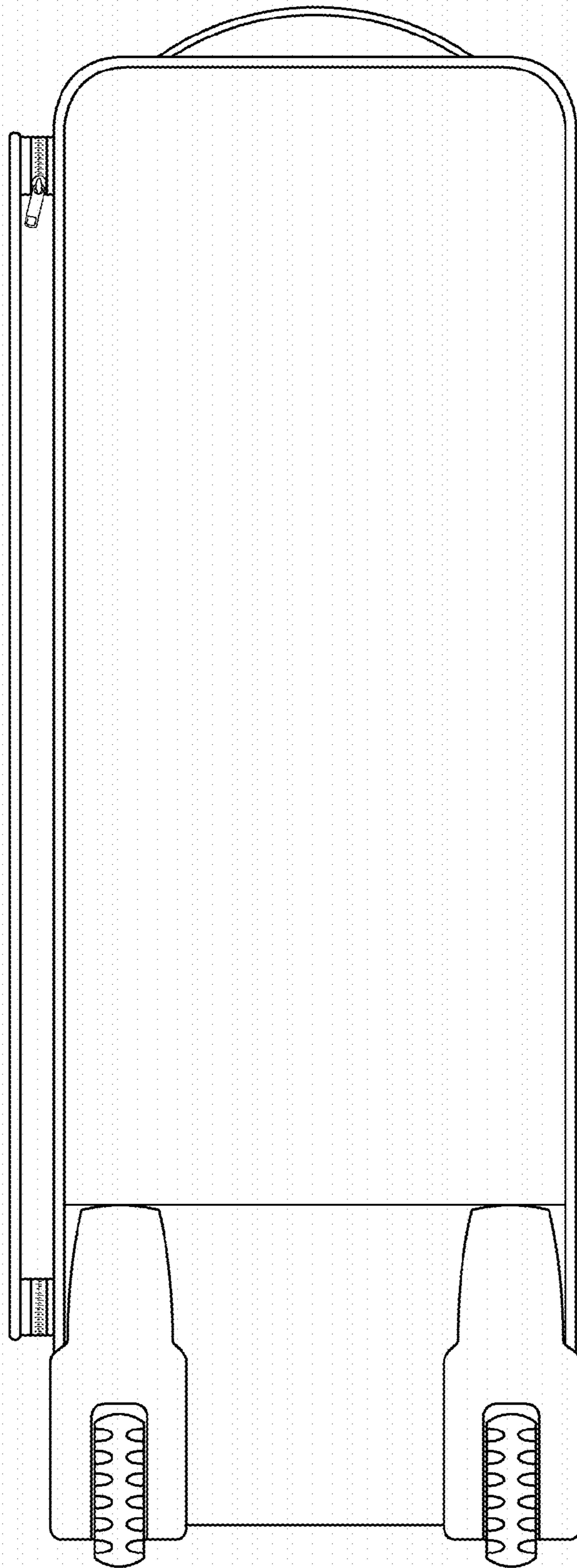

FIG. 4

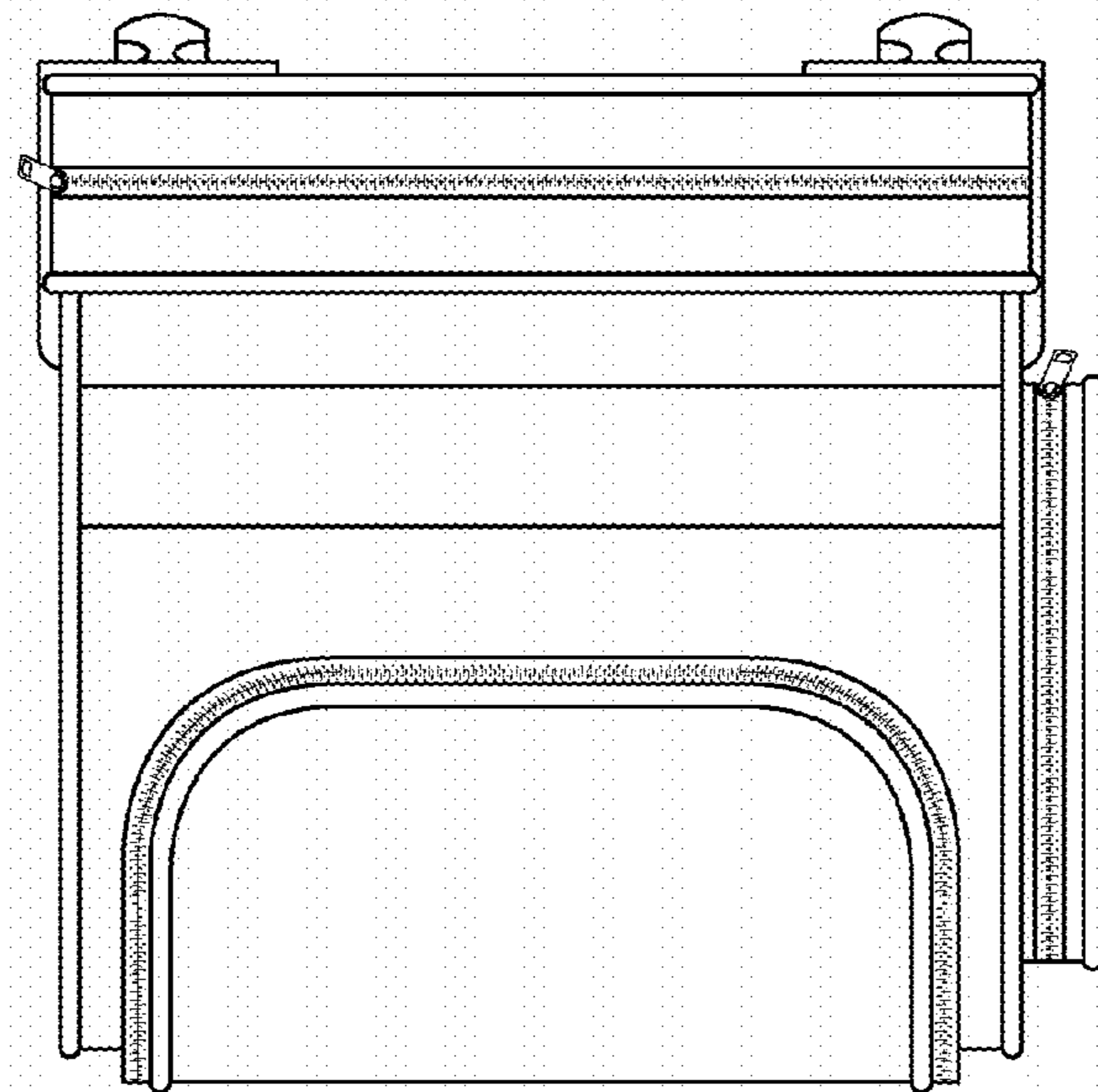

FIG. 5

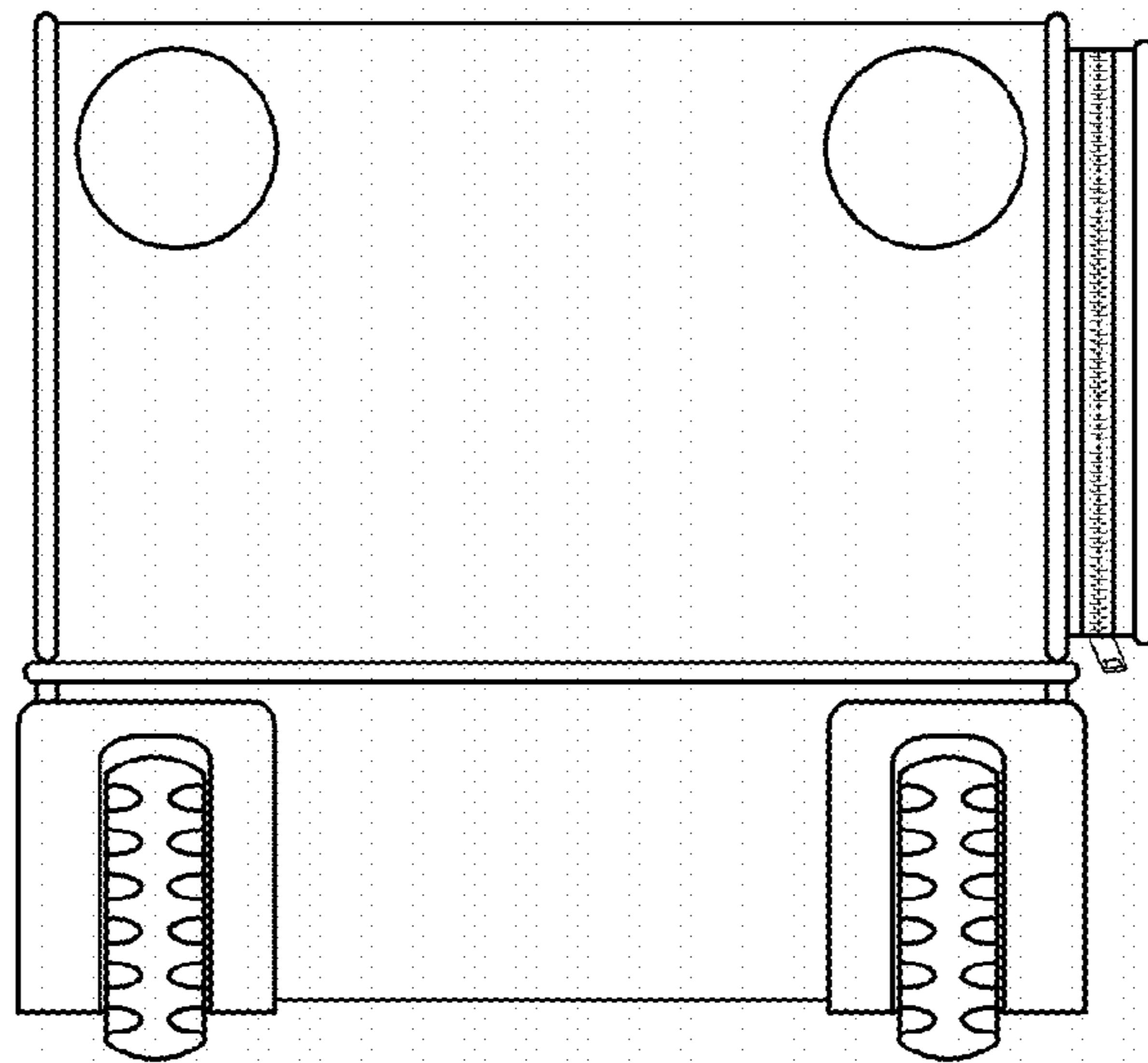

FIG. 6



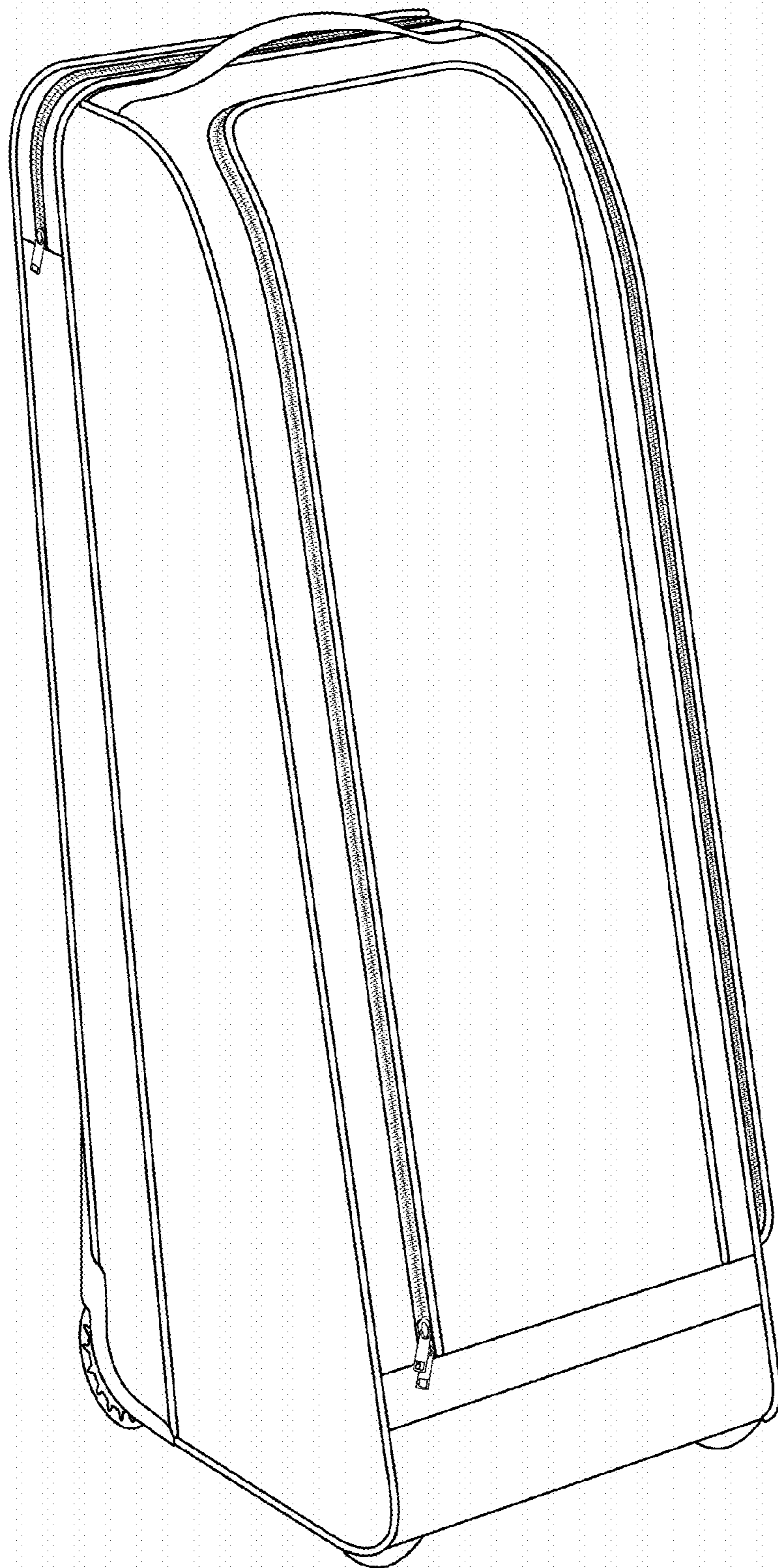

FIG. 7

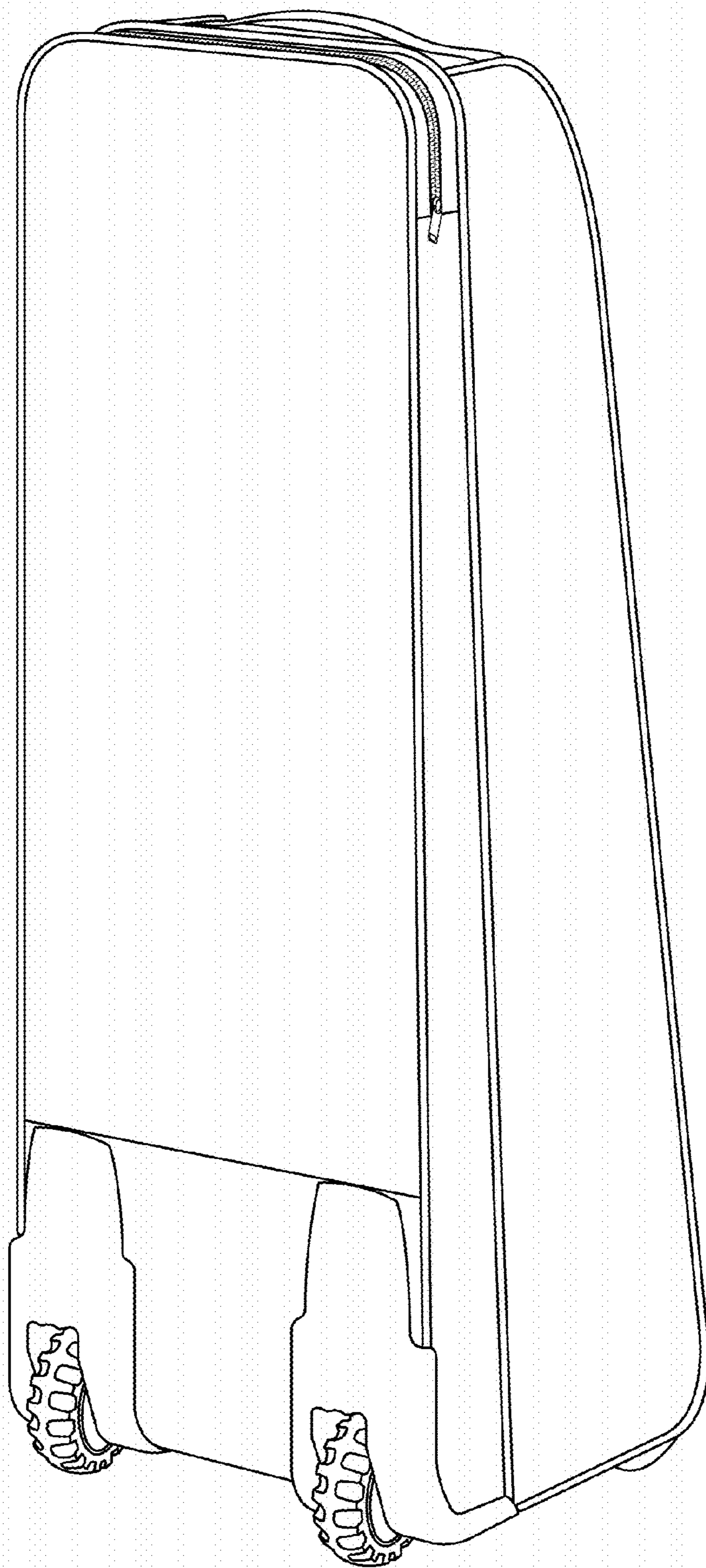

FIG. 8

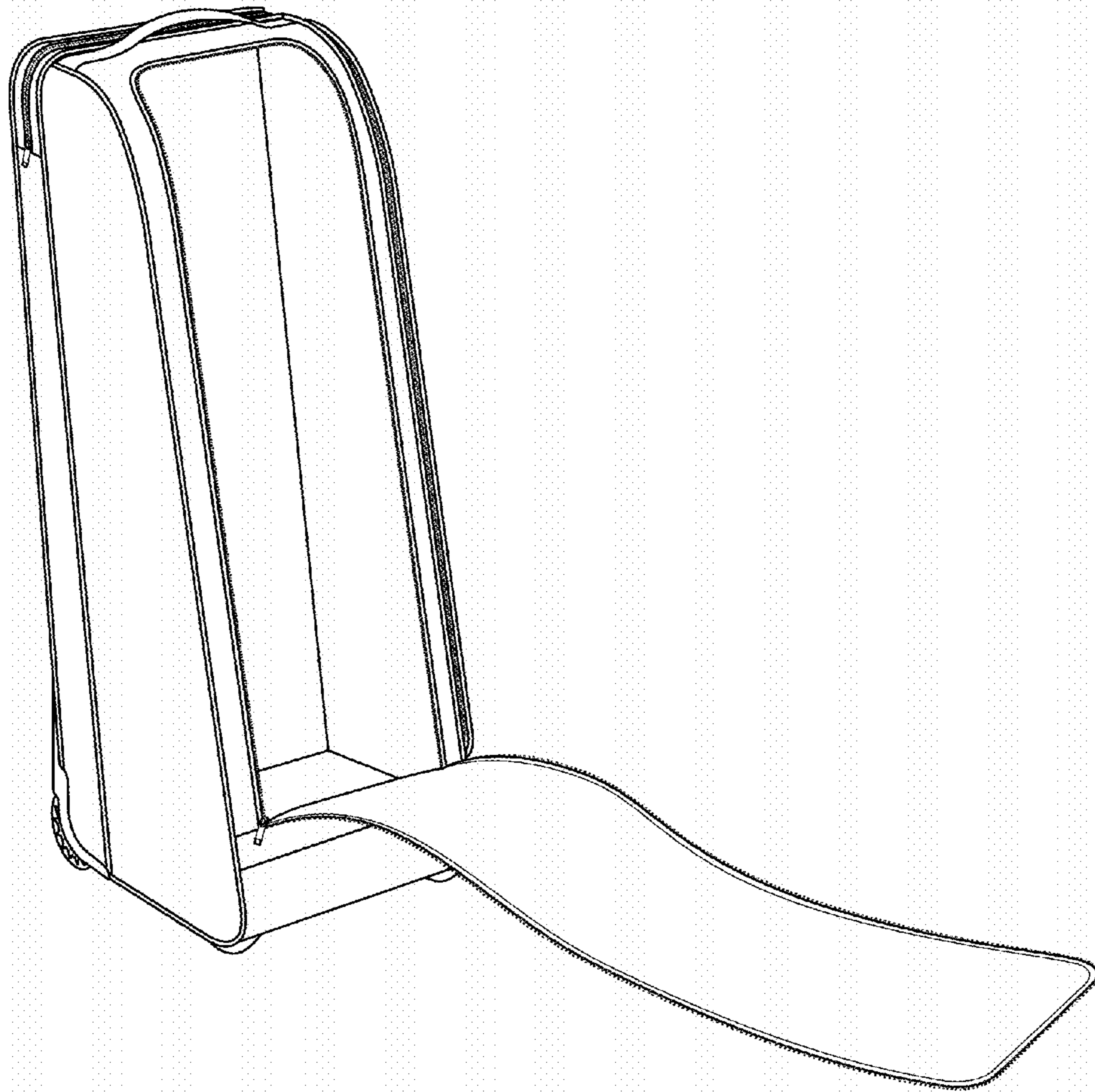

FIG. 9

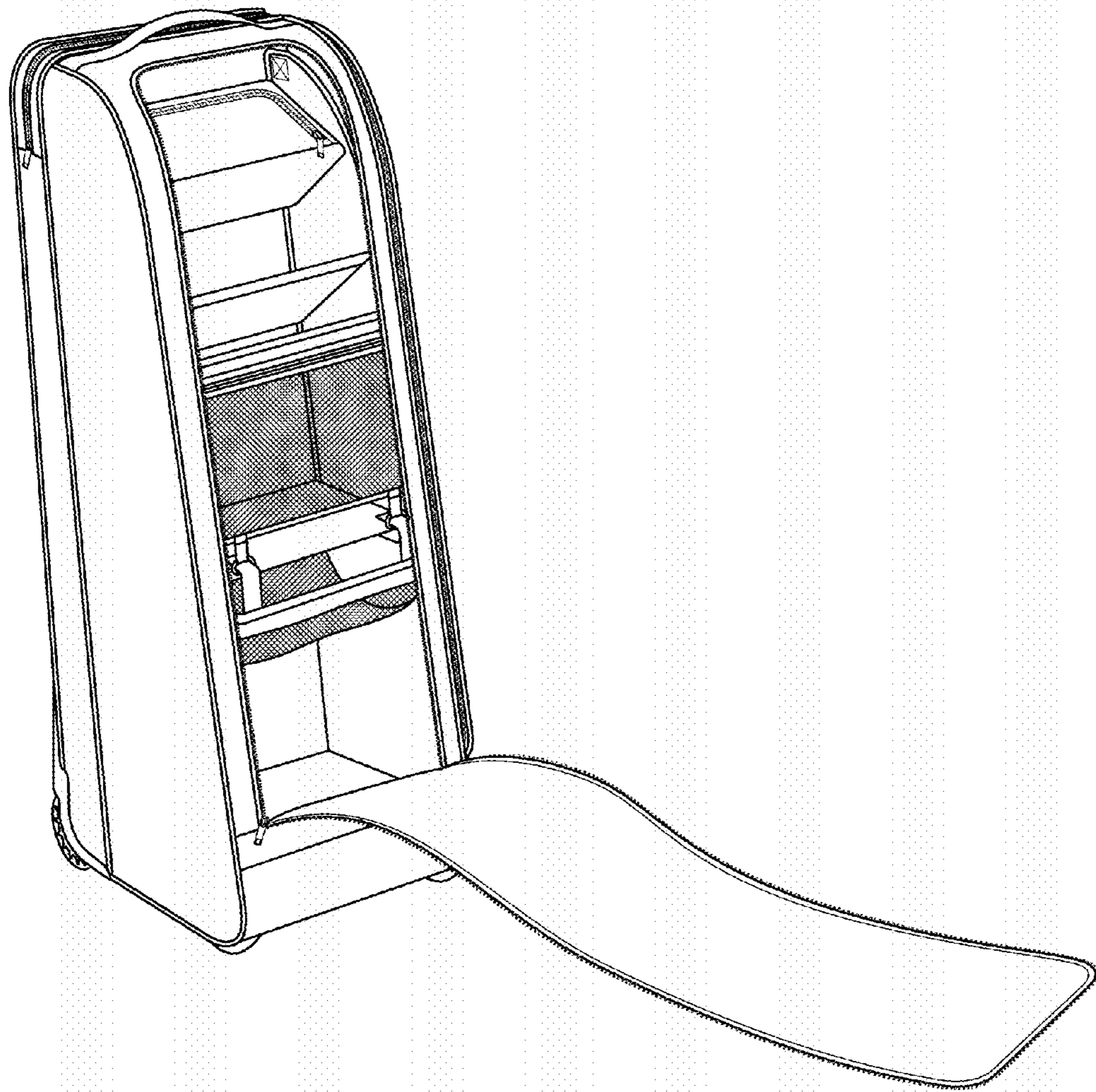

FIG. 10