



US00D747077S

(12) **United States Design Patent**  
**Jayalath et al.**

(10) **Patent No.:** **US D747,077 S**  
(45) **Date of Patent:** **\*\* Jan. 12, 2016**

- (54) **POCKET**
- (71) Applicant: **MAD Apparel, Inc.**, Palo Alto, CA (US)
- (72) Inventors: **Dhananja Pradhan Jayalath**, Redwood City, CA (US); **James Artel Berg**, San Francisco, CA (US); **Gaston MacMillan**, El Cerrito, CA (US); **Hamid Hameed Butt**, Cupertino, CA (US); **Christopher John Wiebe**, Burlingame, CA (US)
- (73) Assignee: **MAD Apparel, Inc.**, Redwood City, CA (US)

(\*\*) Term: **14 Years**

(21) Appl. No.: **29/489,657**

(22) Filed: **May 1, 2014**

(51) **LOC (10) Cl.** ..... **02-02**

(52) **U.S. Cl.**  
USPC ..... **D2/857**

(58) **Field of Classification Search**  
USPC ..... D2/717, 749, 750, 840, 841, 857  
See application file for complete search history.

(56) **References Cited**  
U.S. PATENT DOCUMENTS

- 155,600 A \* 10/1874 Tuttle ..... A41D 27/20  
2/249
- 953,527 A \* 3/1910 Greenberg ..... A41D 27/20  
2/249
- 1,491,711 A \* 4/1924 Levine ..... A41D 27/20  
2/250
- 1,780,874 A \* 11/1930 Friedmann ..... A41D 27/20  
2/247

- 5,090,058 A \* 2/1992 Gerber ..... A41D 27/10  
2/97
- D463,095 S \* 9/2002 Vazquez ..... D2/857
- D591,930 S \* 5/2009 Lorenzi ..... D2/857
- D632,056 S \* 2/2011 Pijut ..... D2/717
- 2007/0056074 A1\* 3/2007 Esses ..... A41D 1/04  
2/69

\* cited by examiner

*Primary Examiner* — Rashida Johnson  
(74) *Attorney, Agent, or Firm* — Jeffrey Schox; Ivan Wong

(57) **CLAIM**  
The ornamental design for a pocket, as shown and described.

**DESCRIPTION**

FIG. 1 is a front elevational view of a pocket showing my new design.  
 FIG. 2 is another front elevational view thereof.  
 FIG. 3 is a perspective view thereof.  
 FIG. 4 is another front elevational view thereof.  
 FIG. 5 is another perspective view thereof.  
 FIG. 6 is a left side elevational view thereof.  
 FIG. 7 is another front elevational view thereof.  
 FIG. 8 is a right side elevational view thereof.  
 FIG. 9 is a top view thereof.  
 FIG. 10 is a bottom view thereof; and,  
 FIG. 11 is yet another perspective view thereof.  
 The line shadings in the figures are included for the purpose of illustrating contour and are not intended to be illustrative of texture or gloss. None of the broken lines form a part of the claimed design.

**1 Claim, 8 Drawing Sheets**

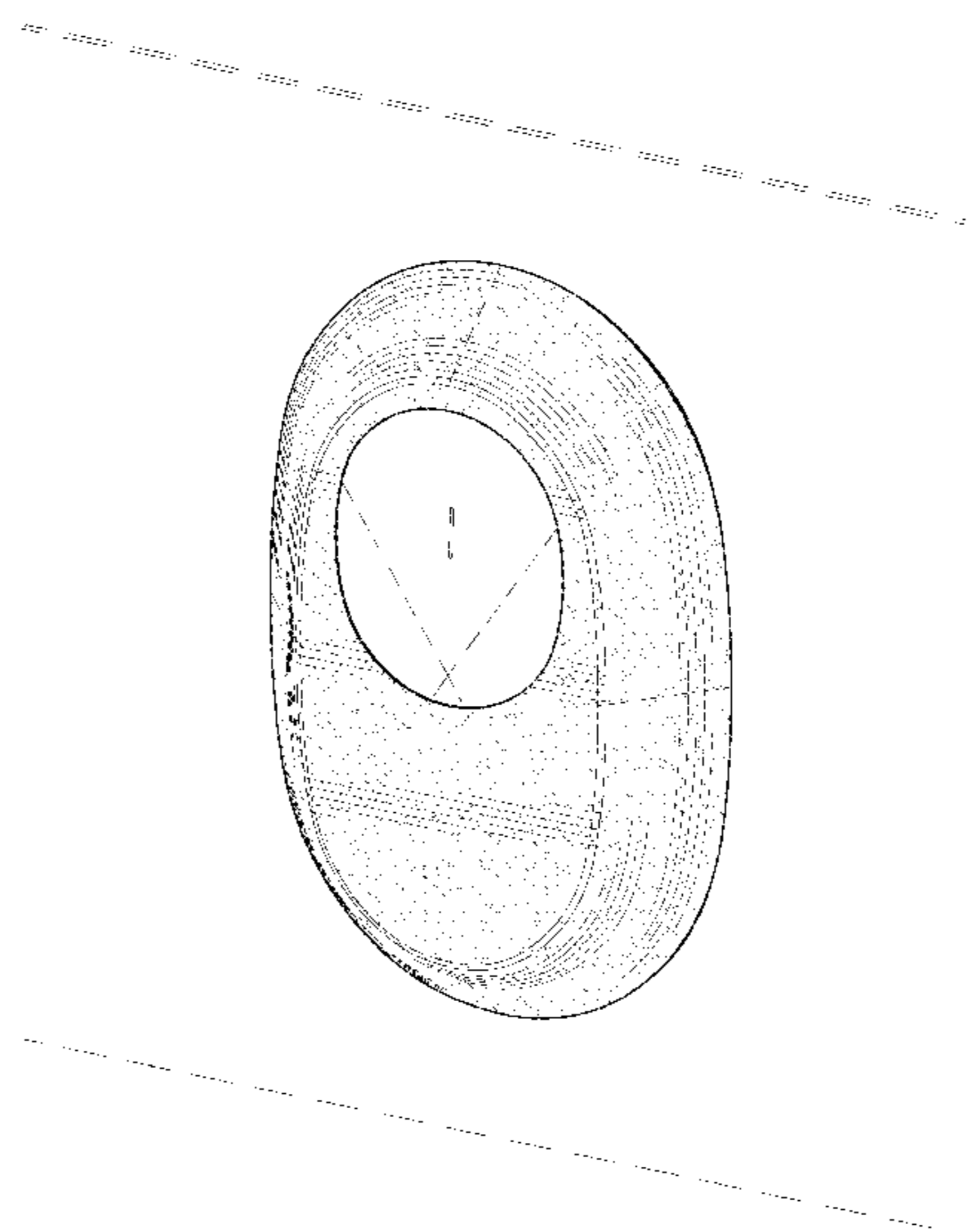
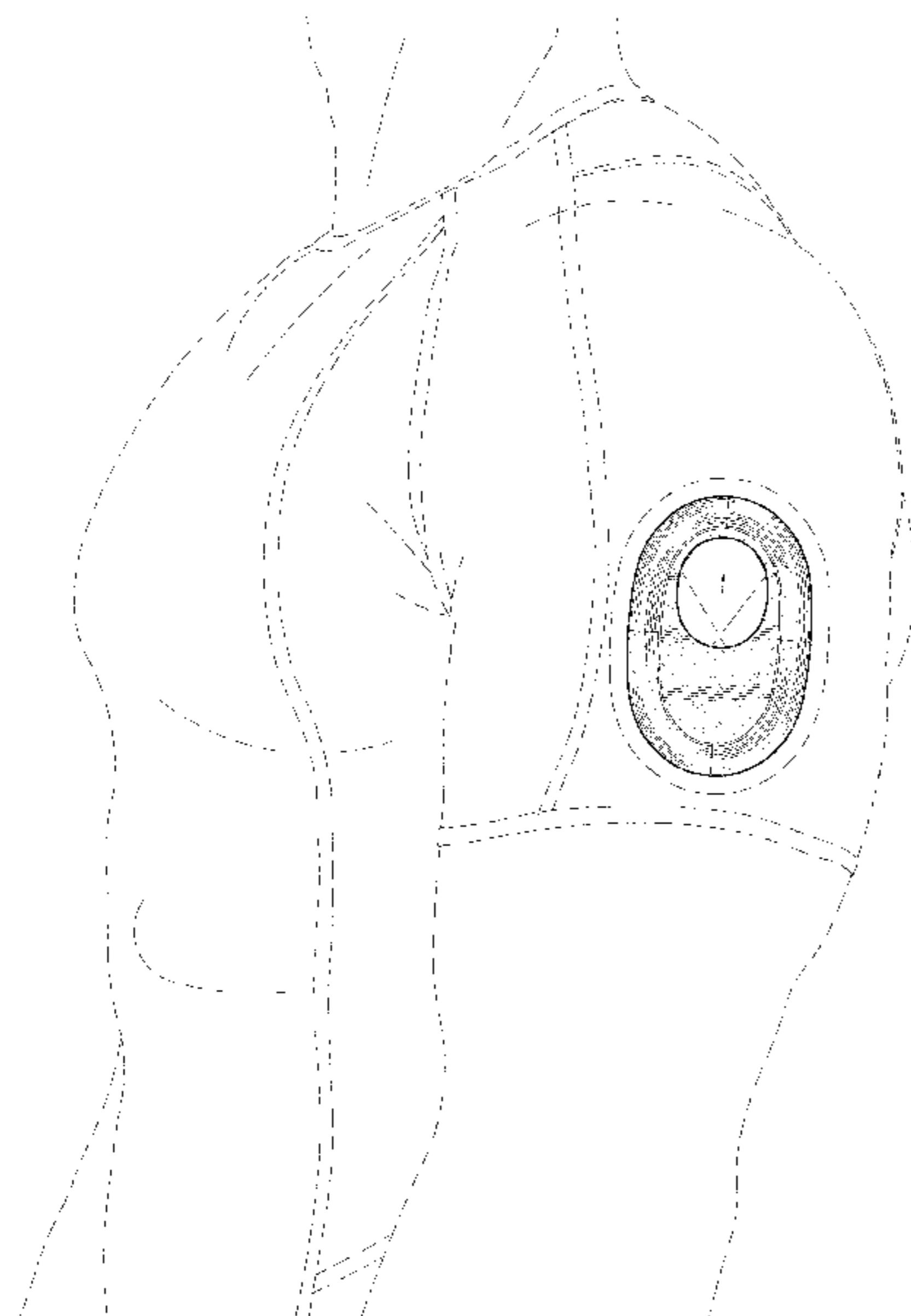

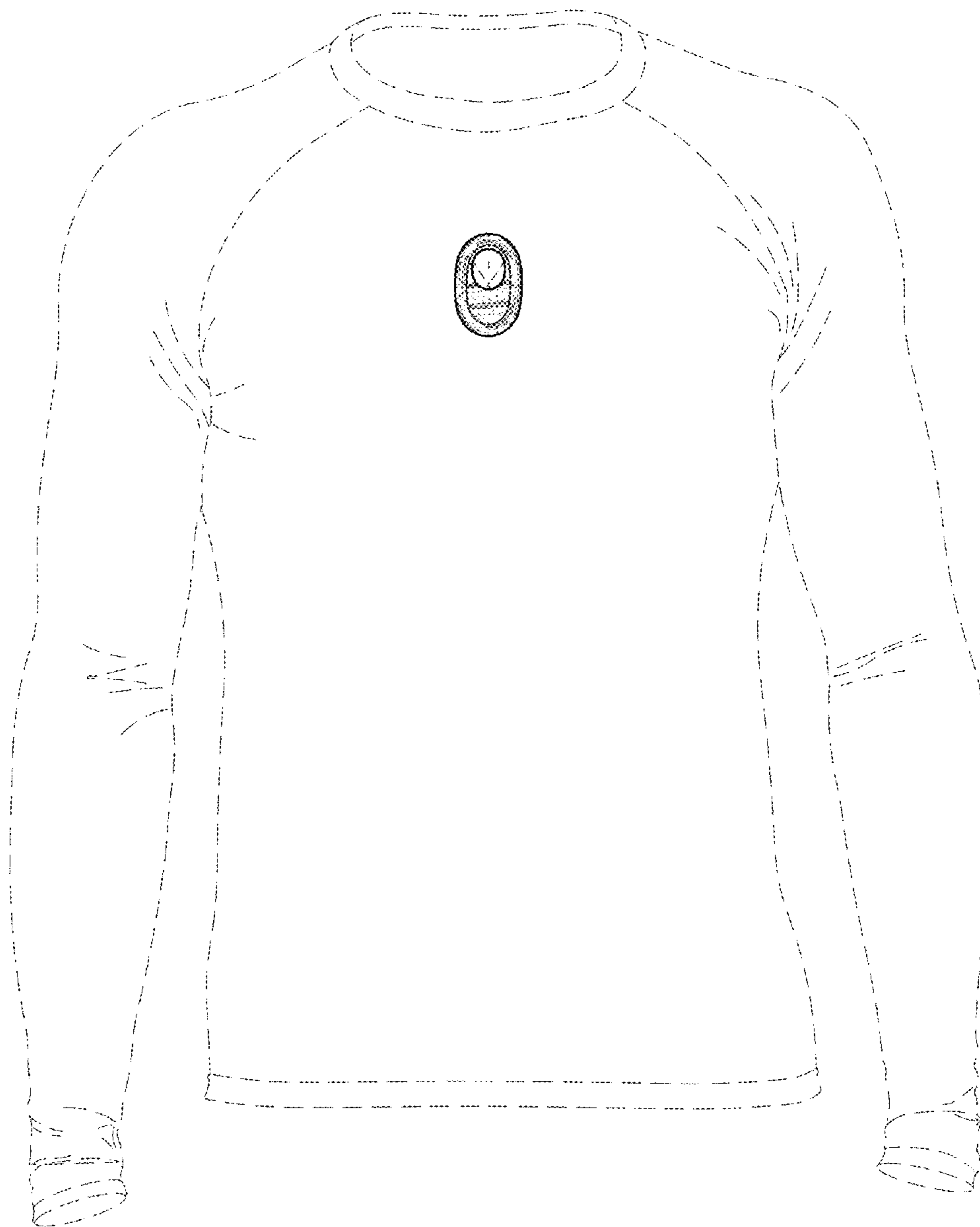
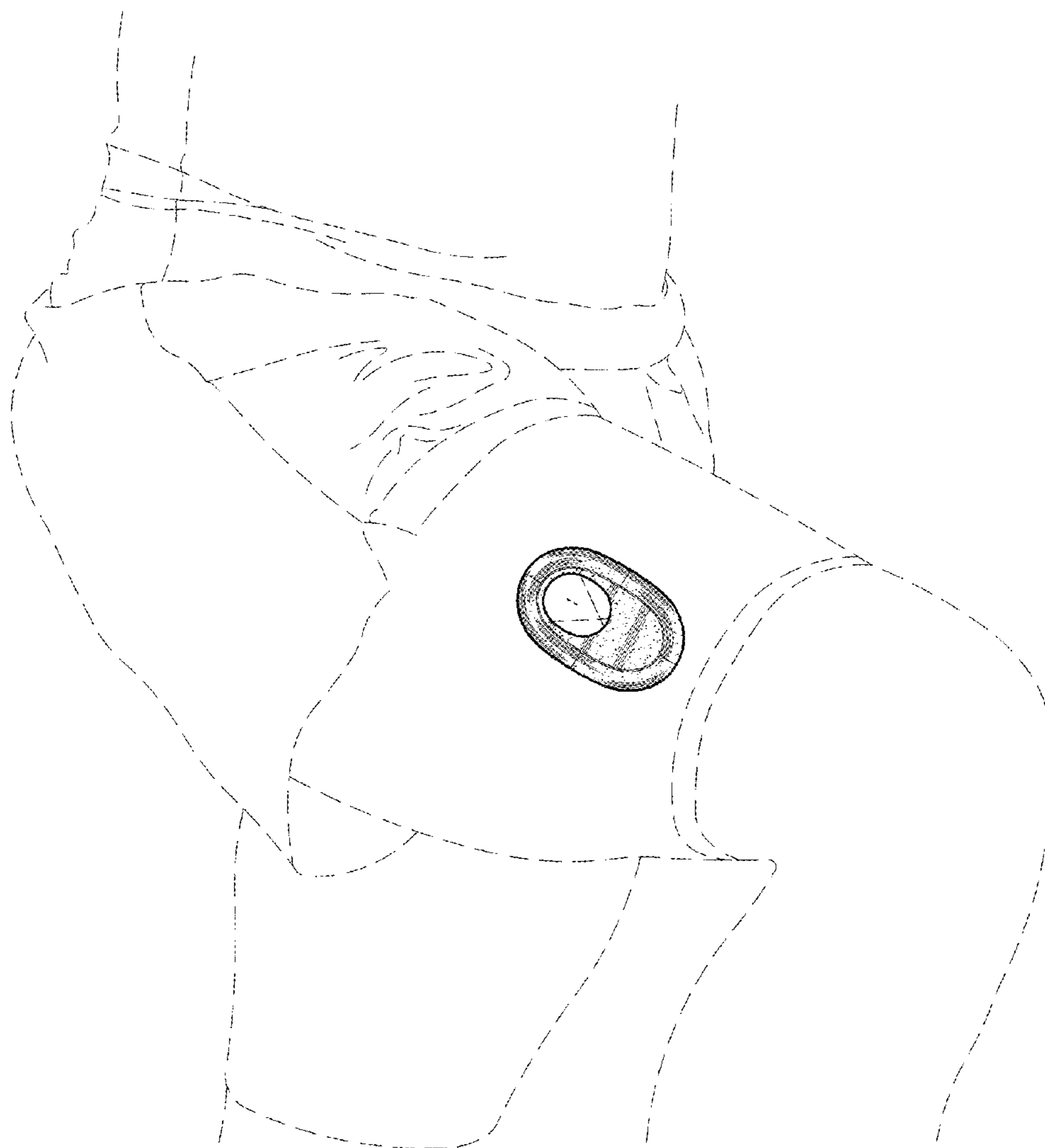

Fig. 1



*Fig. 2*



**Fig. 3**

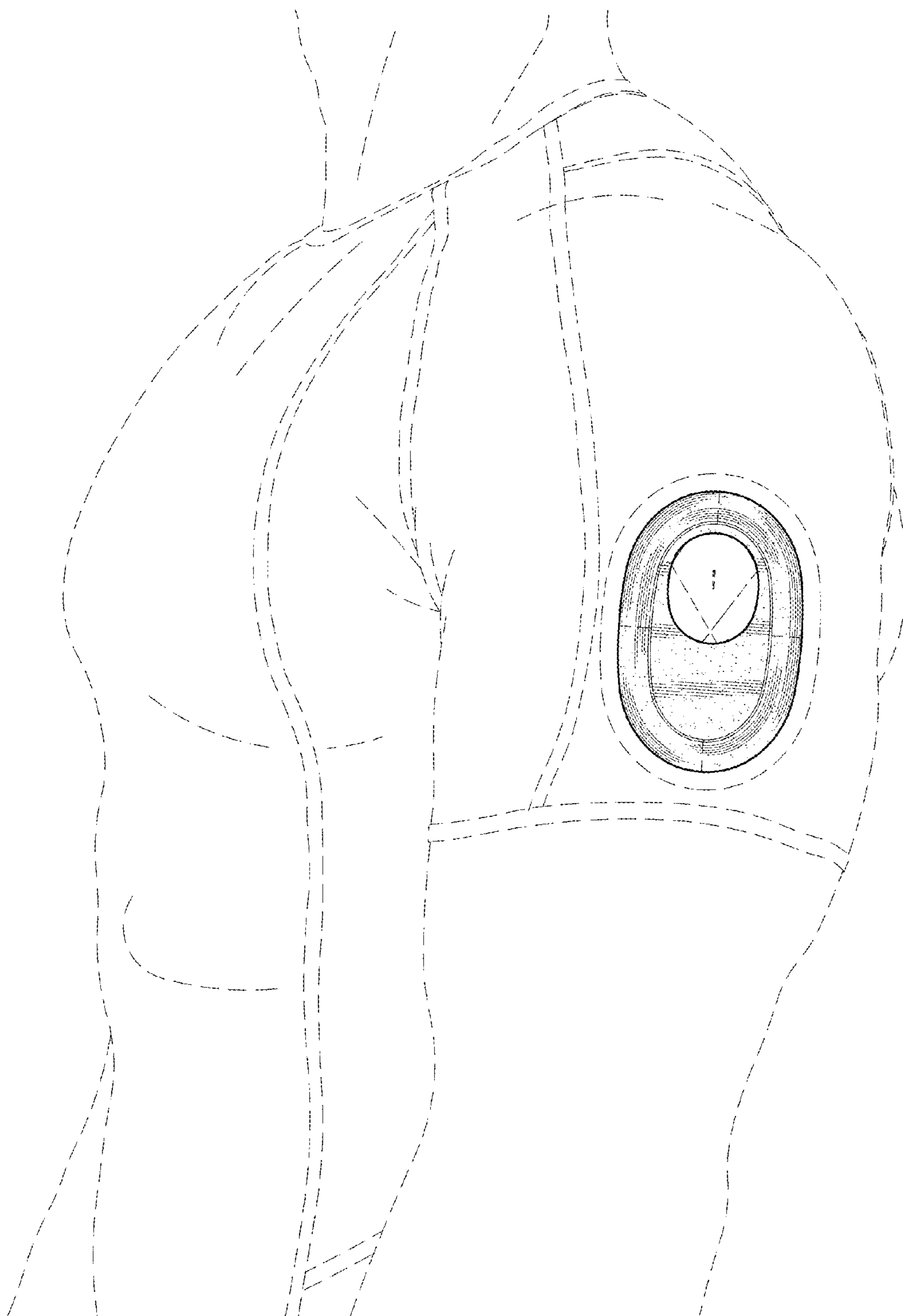

**Fig. 4**

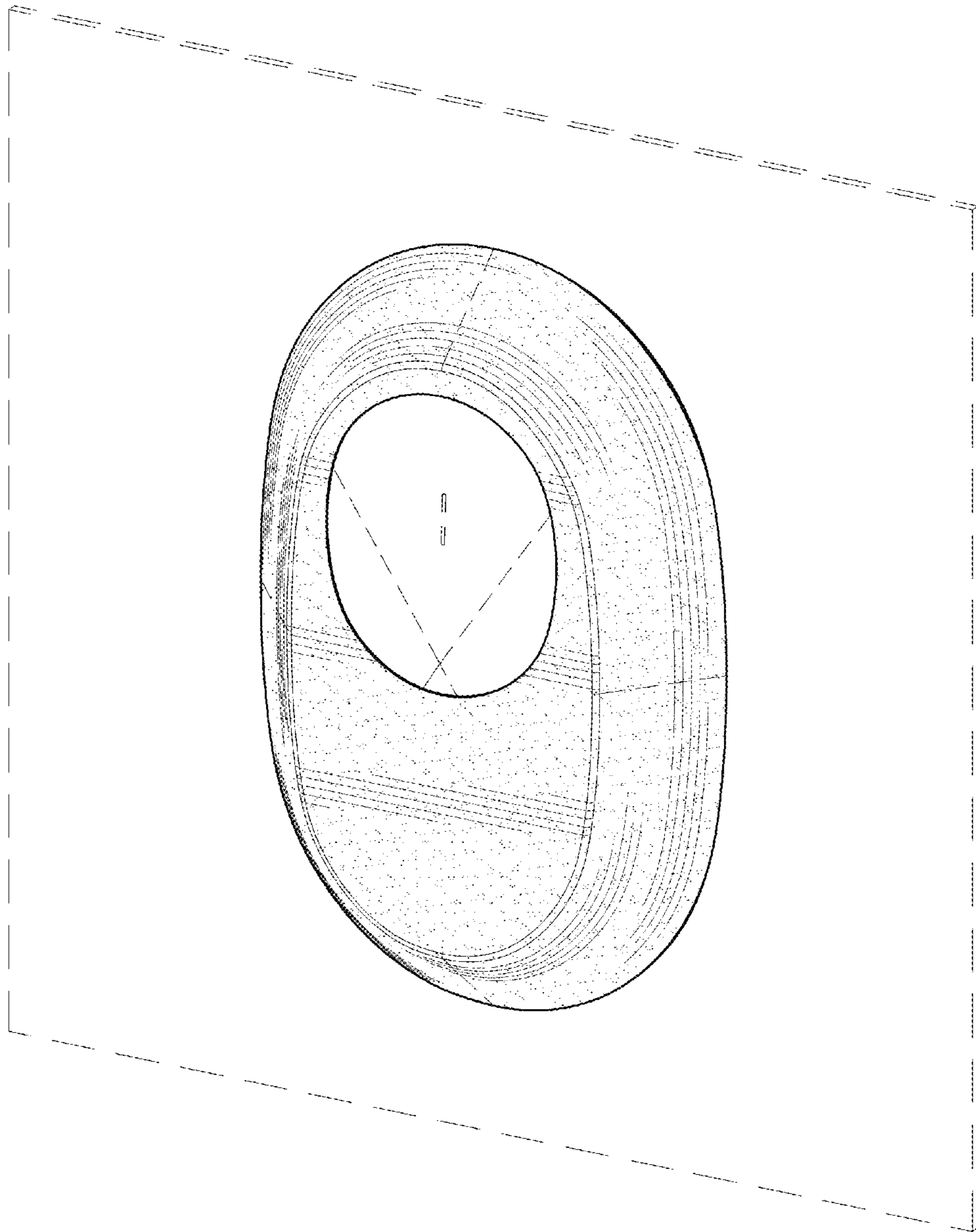

**Fig. 5**

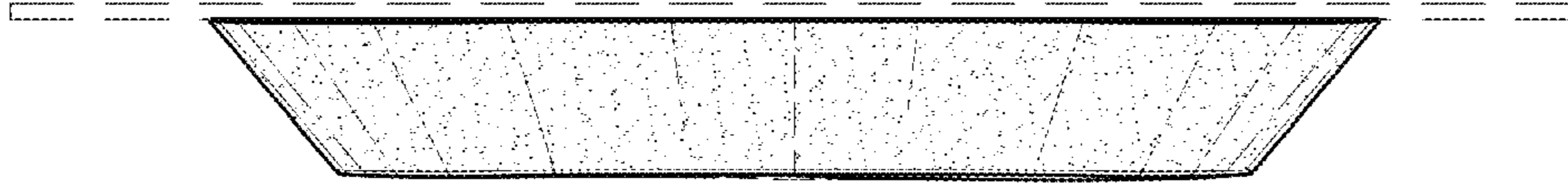

Fig. 8

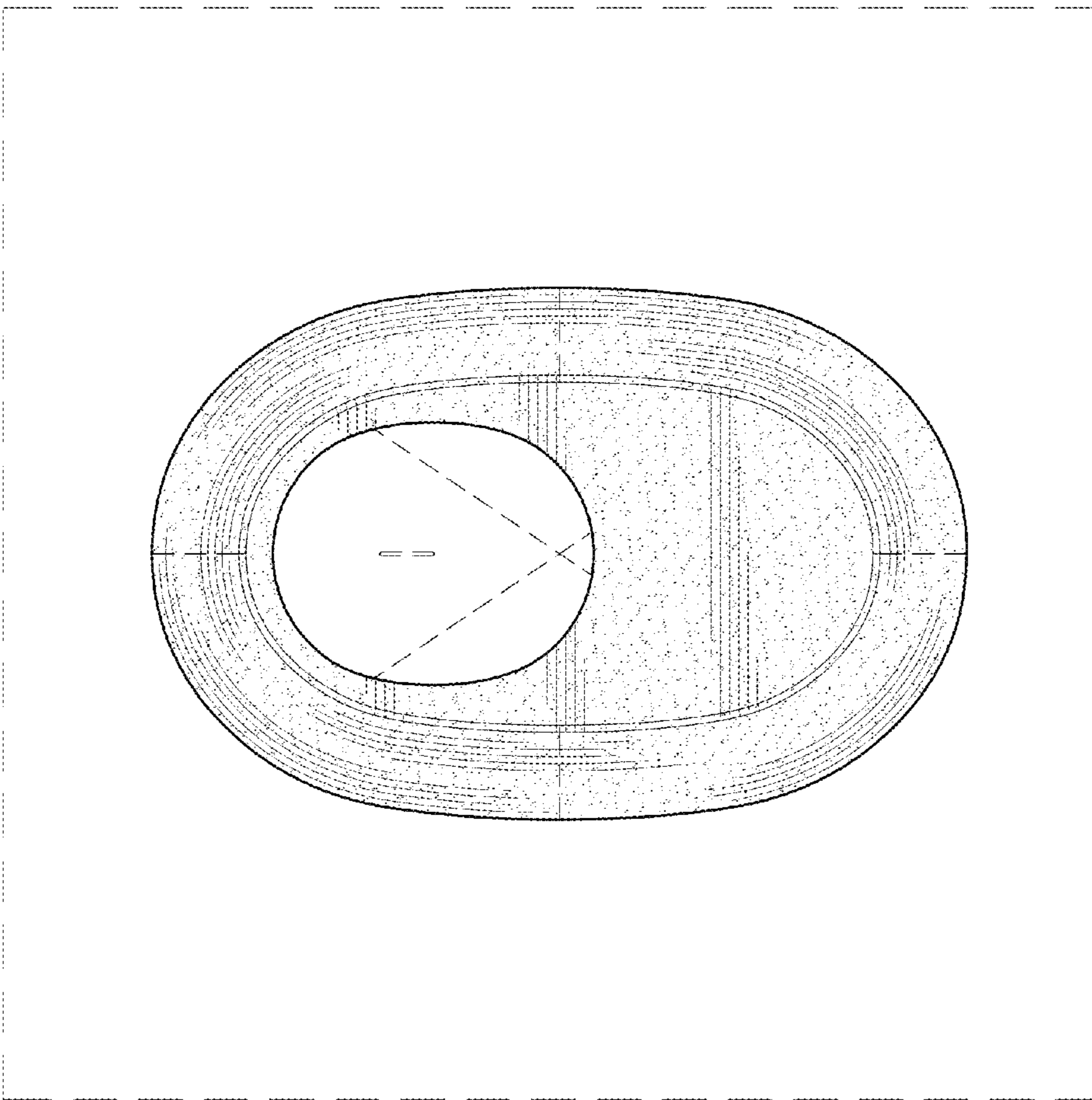

Fig. 7

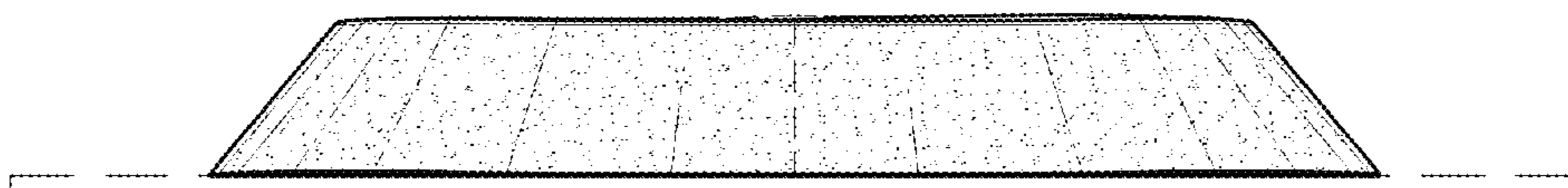
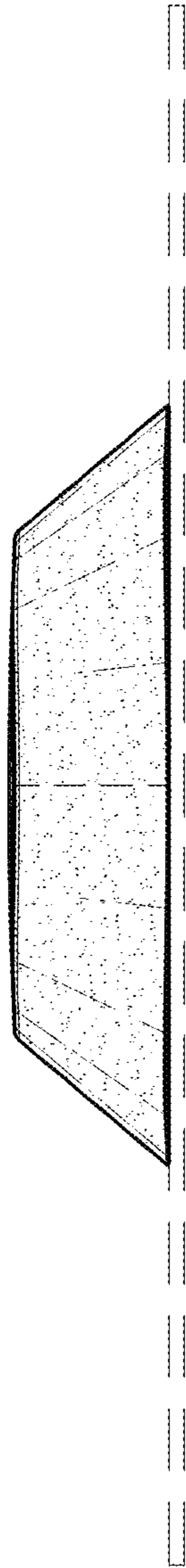
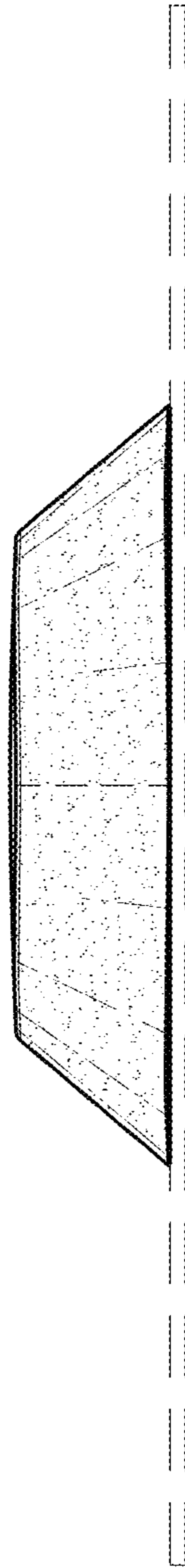

Fig. 6

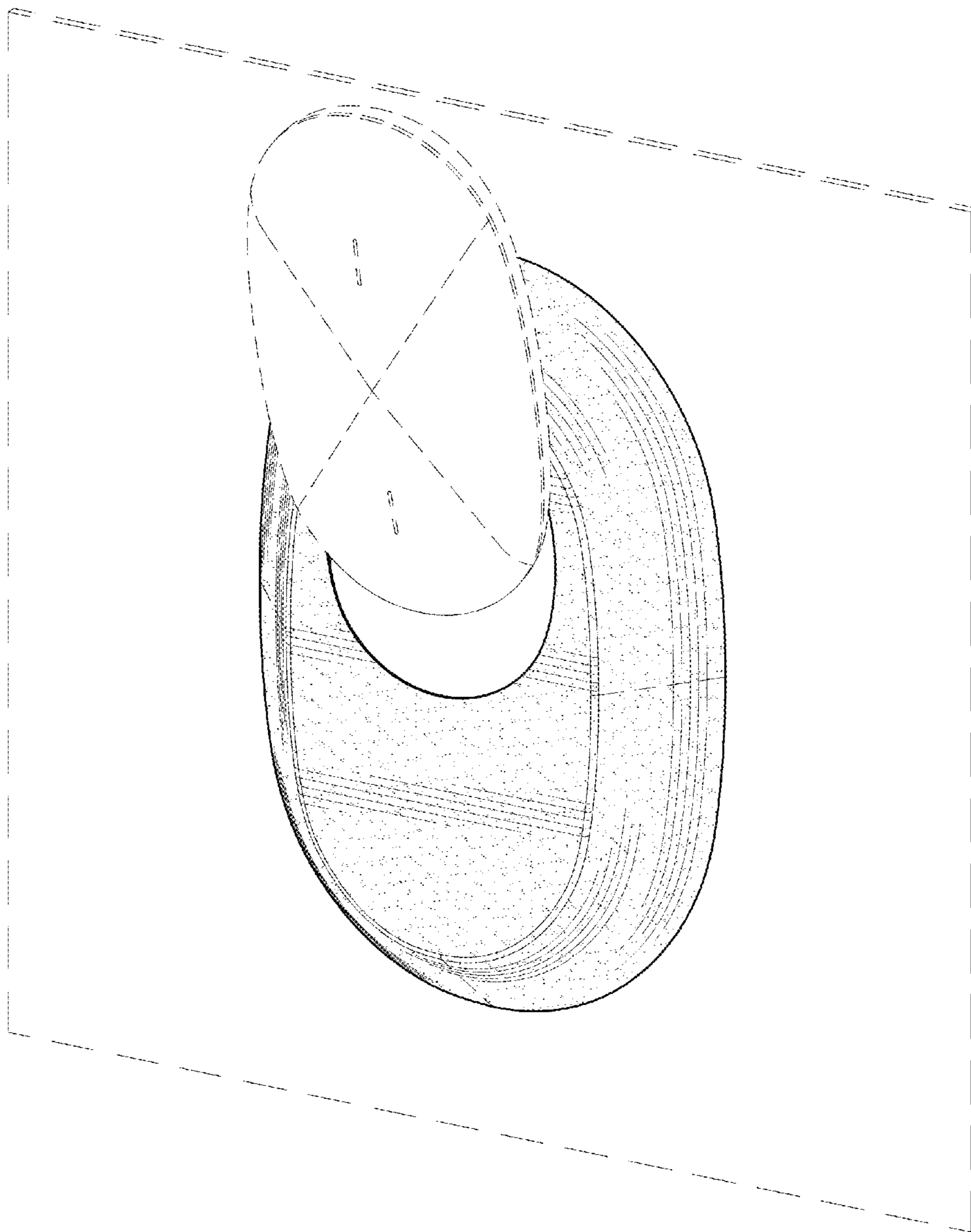

**Fig. 9**



**Fig. 10**





**Fig. 11**