



US00D747053S

(12) **United States Design Patent**  
**Baldwin**

(10) **Patent No.:** **US D747,053 S**  
(45) **Date of Patent:** **\*\* Jan. 5, 2016**

- (54) **CLEANING TOOL**
- (71) Applicant: **3M INNOVATIVE PROPERTIES COMPANY**, St. Paul, MN (US)
- (72) Inventor: **Mark W. Baldwin**, Woodbury, MN (US)
- (73) Assignee: **3M INNOVATIVE PROPERTIES COMPANY**, St. Paul, MN (US)
- (\*\*) Term: **14 Years**
- (21) Appl. No.: **29/495,015**
- (22) Filed: **Jun. 26, 2014**
- (51) **LOC (10) Cl.** ..... **04-01**
- (52) **U.S. Cl.**  
USPC ..... **D32/40**
- (58) **Field of Classification Search**  
USPC ..... D32/40-45, 50; 15/119.1, 244.1, 244.4,  
15/228, 210.1, 229.3, 229.4; 401/137,  
401/138, 140  
CPC ..... A47L 13/24; A47L 13/20; A47L 13/22  
See application file for complete search history.

7,210,188	B1 *	5/2007	Kirby	.....	15/244.4
D585,612	S *	1/2009	Soller et al.	.....	D32/50
D586,966	S *	2/2009	Nobile et al.	.....	D32/50
7,779,501	B2 *	8/2010	Lacotta et al.	.....	15/118
D661,442	S *	6/2012	Kandasamy et al.	.....	D32/40
D704,910	S *	5/2014	Hughes et al.	.....	D32/40
D719,709	S *	12/2014	Gidwell et al.	.....	D32/40

\* cited by examiner

*Primary Examiner* — Robin V Webster  
(74) *Attorney, Agent, or Firm* — Irina Hass

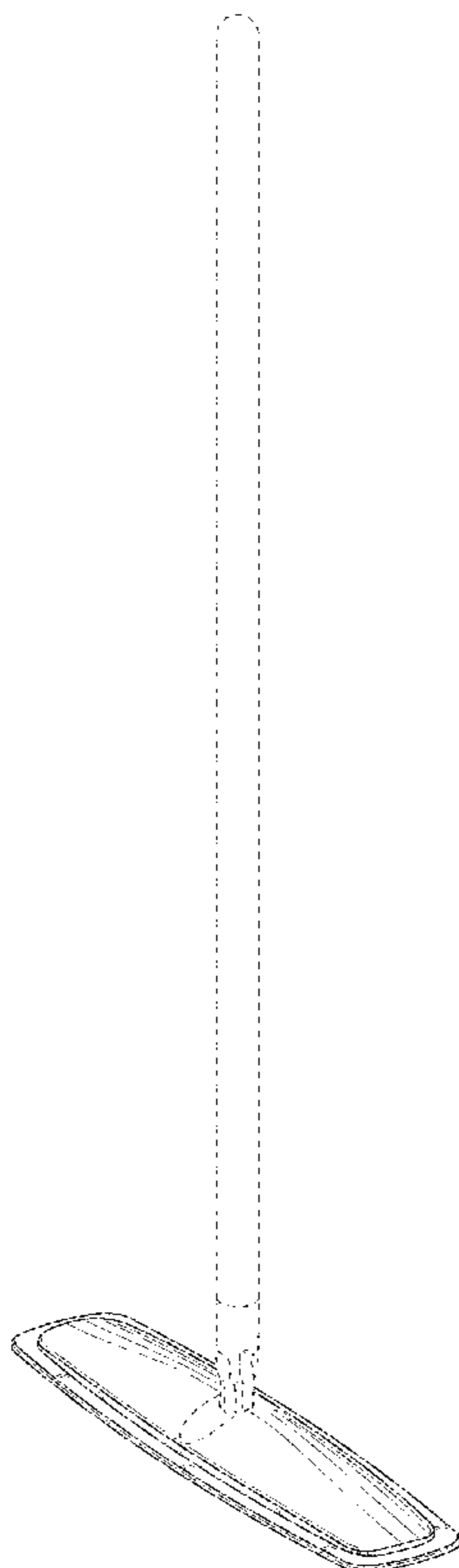
(57) **CLAIM**  
The ornamental design for a cleaning tool, as shown and described.

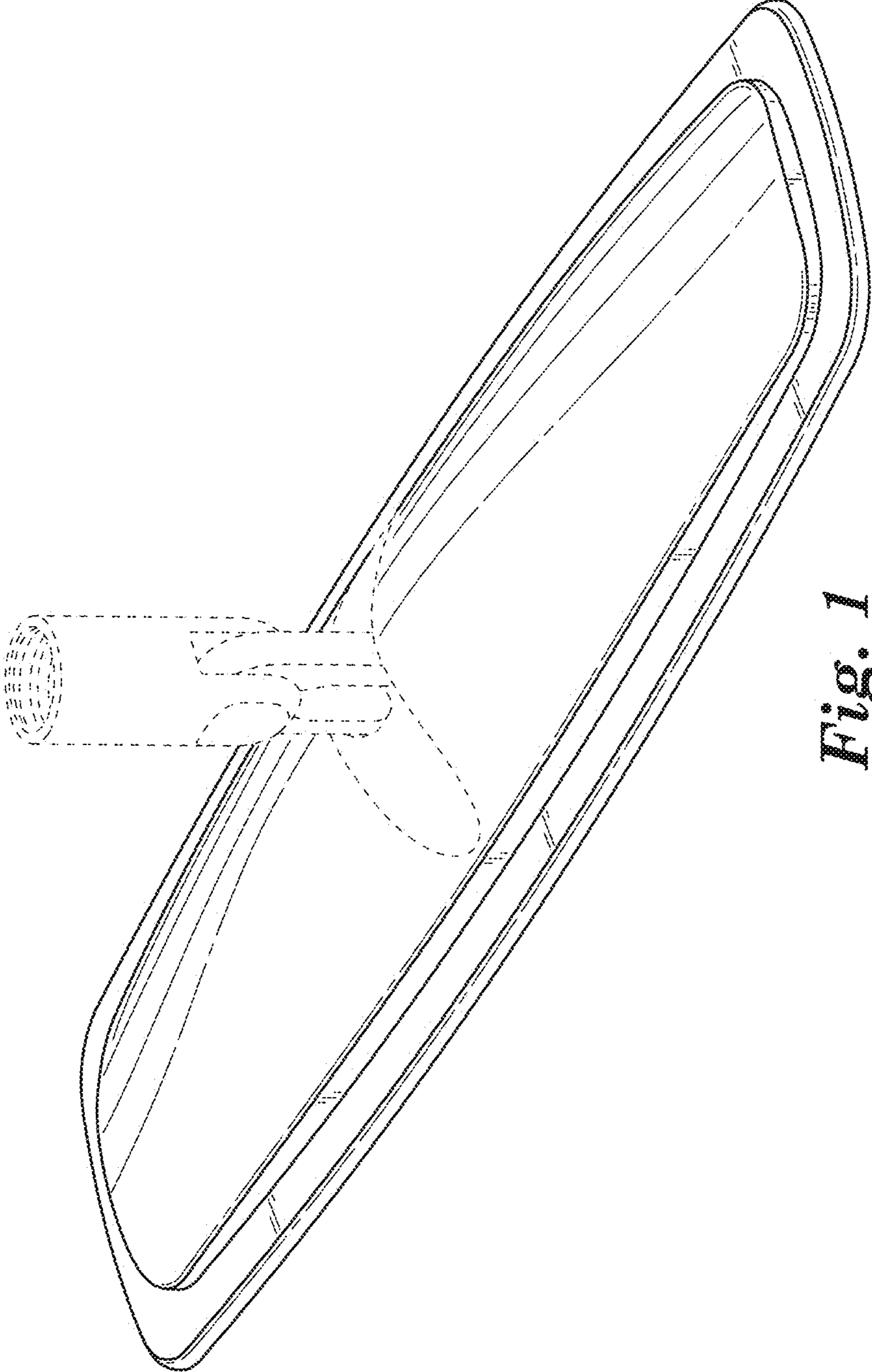
**DESCRIPTION**

FIG. 1 is a perspective view showing the new design for a cleaning tool;  
 FIG. 2 is a front view thereof, a rear view being a mirror image thereof;  
 FIG. 3 is a side view thereof;  
 FIG. 4 is a top view thereof;  
 FIG. 5 is a bottom view thereof; and,  
 FIG. 6 is a perspective view thereof showing the cleaning tool with a handle.  
 The portions of the cleaning tool in FIGS. 1-6 shown in broken lines are included to show features that form no part of the claimed design.

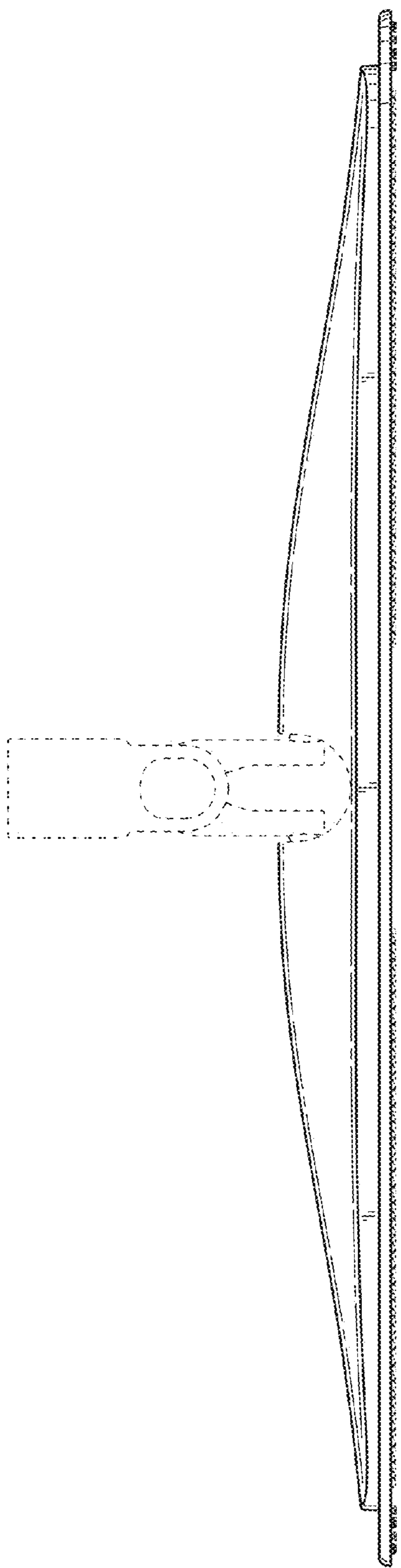
- (56) **References Cited**  
U.S. PATENT DOCUMENTS  
  
D402,776 S \* 12/1998 Carlson ..... D32/50  
6,836,923 B2 \* 1/2005 Treacy et al. .... 15/229.8

**1 Claim, 4 Drawing Sheets**

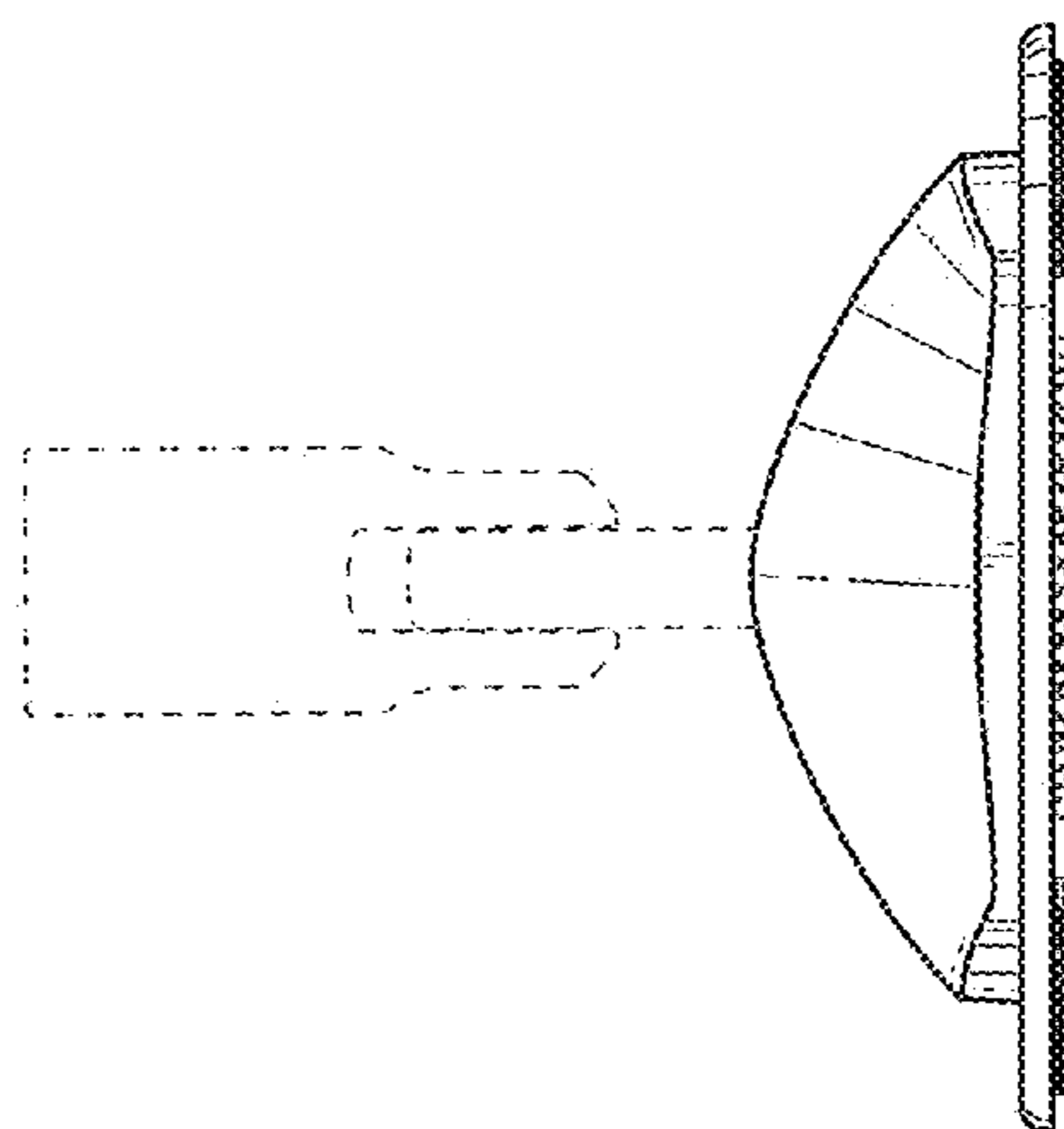




*Fig. 1*



*Fig. 2*



*Fig. 3*

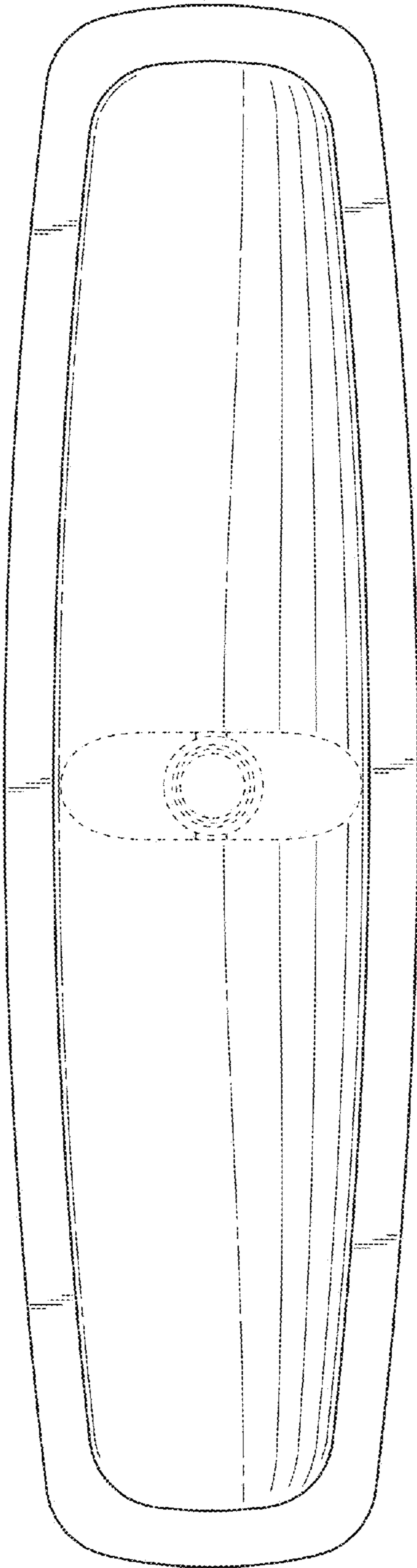


Fig. 4

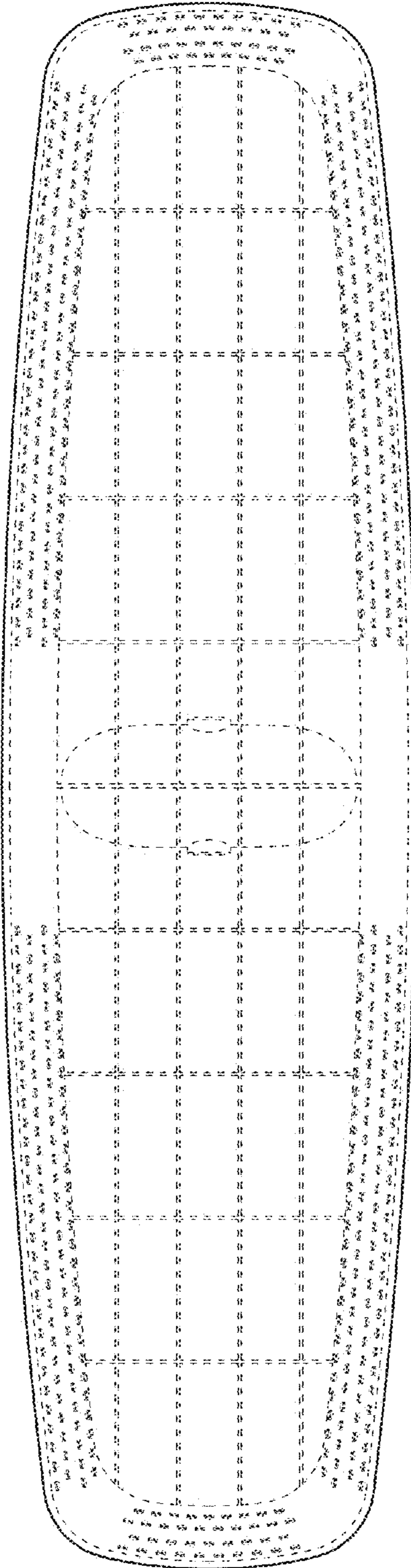
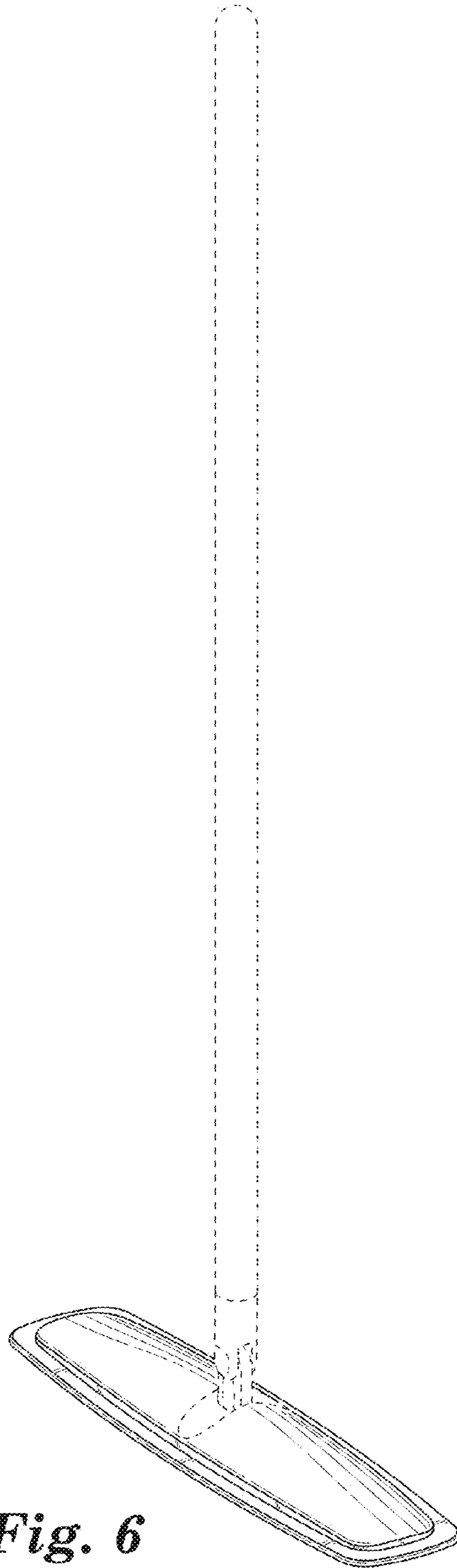


Fig. 5



*Fig. 6*