



US00D746941S

(12) **United States Design Patent**
Bartell

(10) **Patent No.:** **US D746,941 S**
(45) **Date of Patent:** **** Jan. 5, 2016**

(54) **FISH HOOK WITH A CURVED POINT**
(71) Applicant: **Wright & McGill Co.**, Denver, CO (US)
(72) Inventor: **Joseph E. Bartell**, Littleton, CO (US)
(73) Assignee: **WRIGHT & MCGILL CO.**, Denver, CO (US)
(**) Term: **14 Years**

D288,467 S 2/1987 Sitton
4,723,372 A 2/1988 Moser
4,802,300 A 2/1989 Fujii et al.
4,819,366 A 4/1989 Manno
4,901,467 A 2/1990 Stolpe
4,905,402 A 3/1990 Clark
4,905,403 A 3/1990 Manno
5,165,197 A 11/1992 Sitton
5,179,809 A 1/1993 Schroeder
5,214,875 A 6/1993 Hoben et al.
5,297,356 A 3/1994 Wickham

(Continued)

(21) Appl. No.: **29/488,342**

(22) Filed: **Apr. 17, 2014**

(51) **LOC (10) Cl.** **22-05**

(52) **U.S. Cl.**
USPC **D22/144**

(58) **Field of Classification Search**
USPC D22/144; 43/4.5, 37, 43.16, 44.8,
43/44.83, 44.95; D3/28
See application file for complete search history.

(56) **References Cited**

U.S. PATENT DOCUMENTS

627,179 A 6/1899 Dreese
842,594 A 1/1907 Vleck
1,072,172 A 9/1913 Schell
1,430,626 A 10/1922 Christensen
1,513,400 A 10/1924 Koski
1,604,031 A 10/1926 Ferguson
2,164,807 A 7/1939 Evans
2,514,527 A 7/1950 Verhota
2,531,981 A * 11/1950 Liebe 43/43.16
2,539,735 A 1/1951 Forsyth
2,823,485 A 3/1956 Traumüller
3,505,756 A 4/1970 Bowden
3,604,143 A 9/1971 Sauers
D222,833 S * 1/1972 Fujii et al. D22/144
4,126,957 A 11/1978 Randall
D276,360 S 11/1984 Sitton

FOREIGN PATENT DOCUMENTS

GB 1204223 9/1970
GB 2067882 8/1981

(Continued)

Primary Examiner — Catheri Oliver-Garcia
(74) *Attorney, Agent, or Firm* — Sheridan Ross P.C.

(57) **CLAIM**
The ornamental design for a fish hook with a curved point, as shown and described.

DESCRIPTION

FIG. 1 is a front perspective view of a fish hook with a curved point;
FIG. 2 is a left side elevation view of the design of FIG. 1;
FIG. 3 is a right side elevation view of the design of FIG. 1;
FIG. 4 is a rear elevation view of the design of FIG. 1;
FIG. 5 is a front elevation view of the design of FIG. 1;
FIG. 6 is a top plan view of the design of FIG. 1; and,
FIG. 7 is a bottom plan view of the design of FIG. 1.
The broken lines in the drawings are provided for the purpose of illustrating environment and form no part of the claimed design.

1 Claim, 4 Drawing Sheets

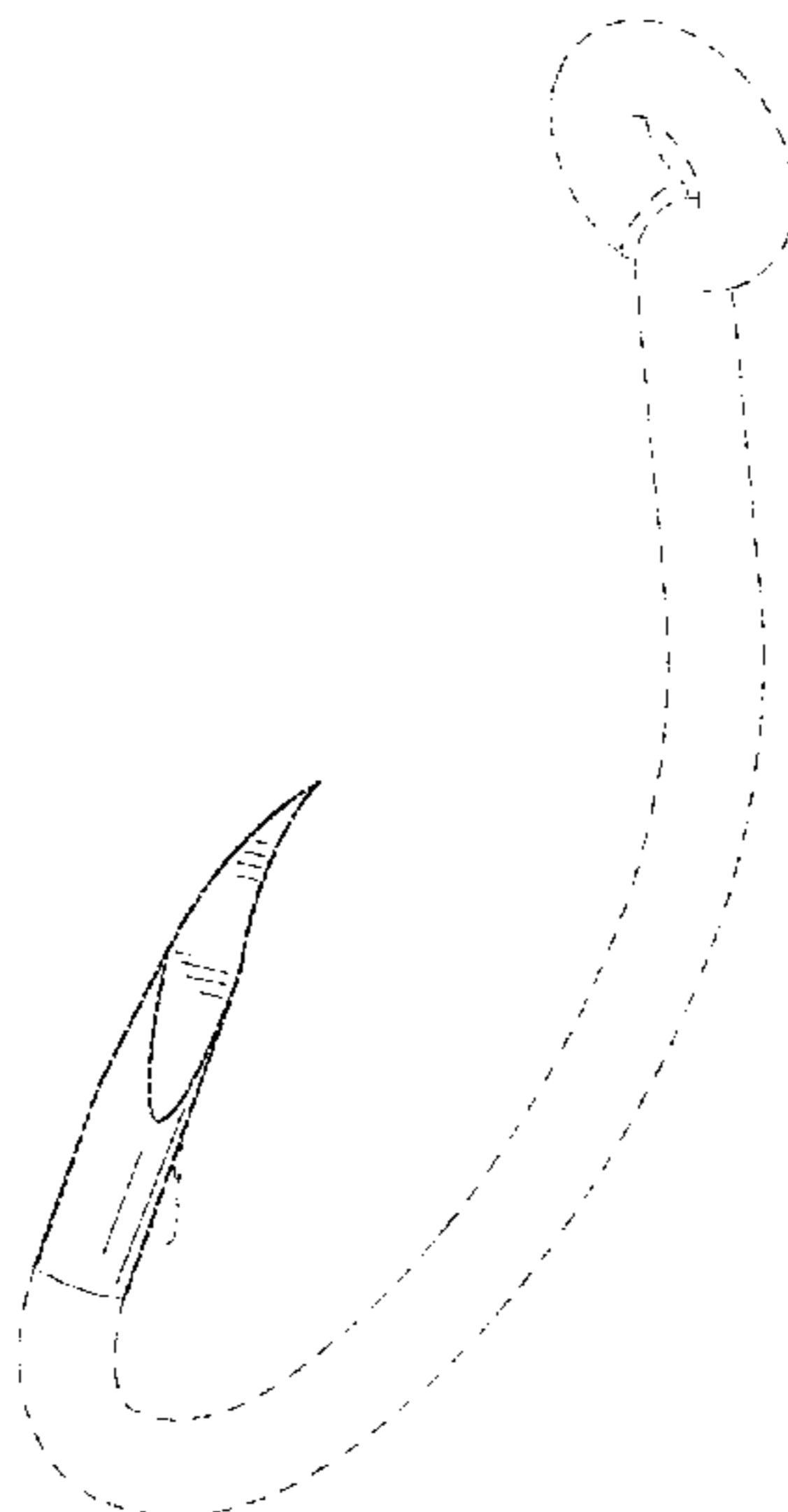

(56)

References Cited

U.S. PATENT DOCUMENTS

D370,520 S *	6/1996	Kahng	D22/144
5,526,603 A	6/1996	Fujii et al.	
5,618,297 A	4/1997	Hart et al.	
5,624,459 A	4/1997	Kortenbach et al.	
5,685,108 A	11/1997	Lepage et al.	
6,053,927 A	4/2000	Hamas	
6,334,273 B2	1/2002	Turner et al.	
6,637,148 B1 *	10/2003	Stallings	43/44.8
D487,913 S *	3/2004	Asada	D22/144
6,910,297 B1	6/2005	Sitton	
D507,034 S *	7/2005	Robertson	D22/144
7,159,357 B2	1/2007	Sitton	
D541,900 S	5/2007	Scott	
D594,526 S	6/2009	Ferguson et al.	
D594,527 S	6/2009	Ferguson et al.	

D594,528 S	6/2009	Ferguson et al.
7,571,564 B2	8/2009	Sullivan
8,707,613 B2	4/2014	Bartell
2004/0195718 A1	10/2004	Obrachta et al.
2005/0076557 A1	4/2005	Fujii
2005/0241214 A1	11/2005	Ferguson
2010/0257711 A1	10/2010	Ferguson et al.
2012/0291334 A1	11/2012	Bartell

FOREIGN PATENT DOCUMENTS

JP	2005-224236	8/2005
JP	2005-348668	12/2005
NO	39388	7/1924
WO	WO 97/04648	2/1997
WO	WO 97/14302	4/1997

* cited by examiner

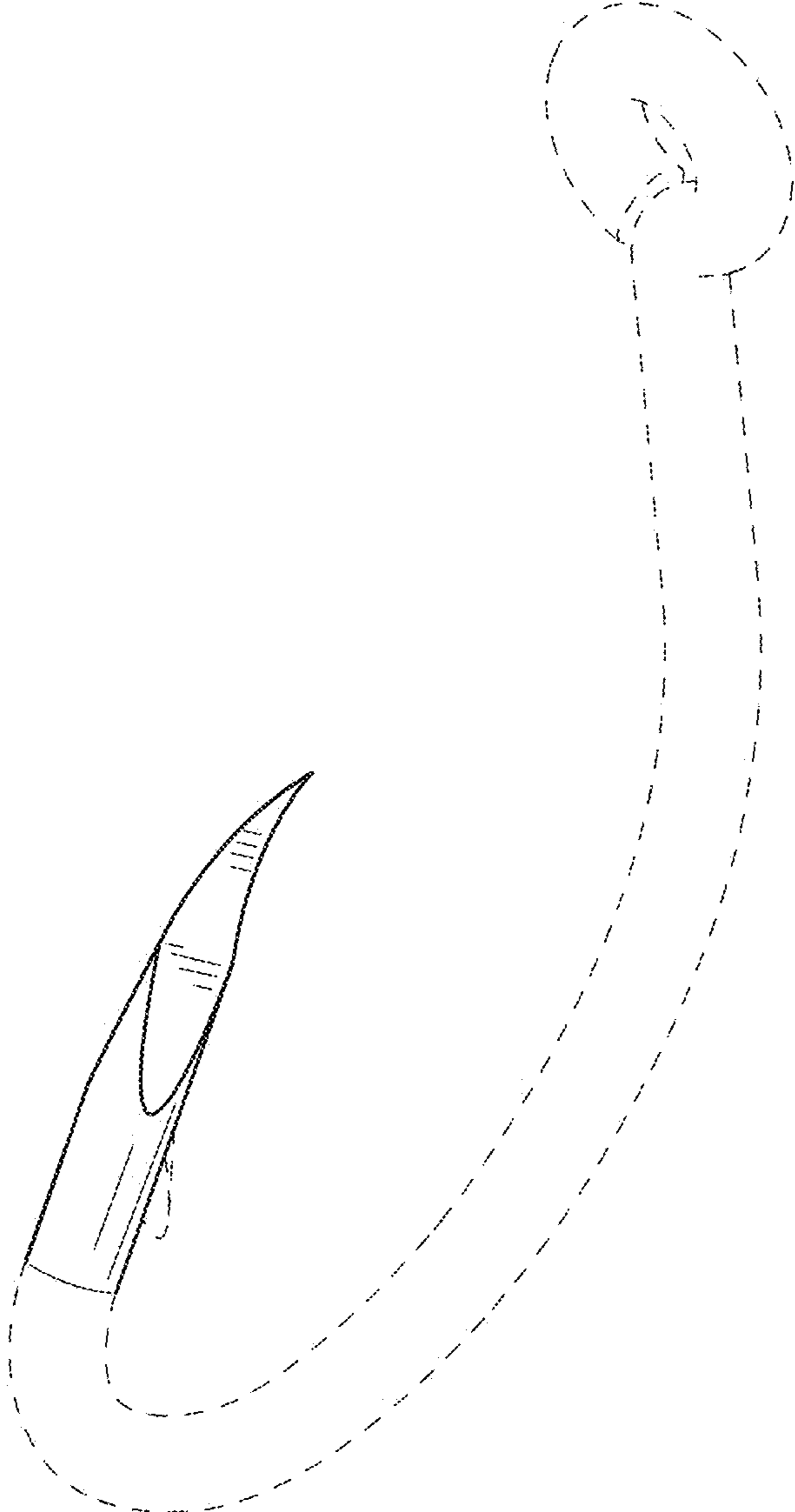

FIG.1

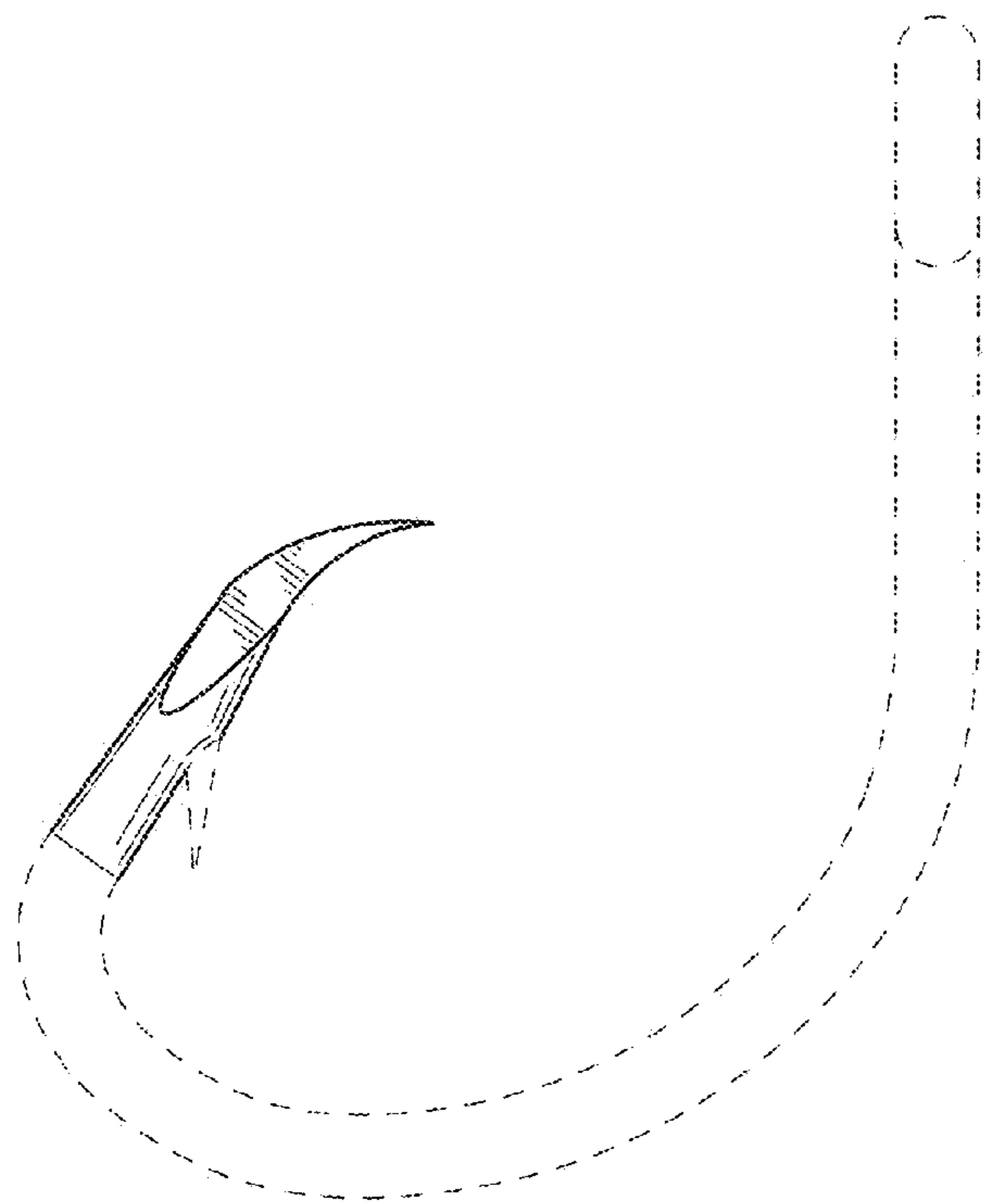

FIG. 2

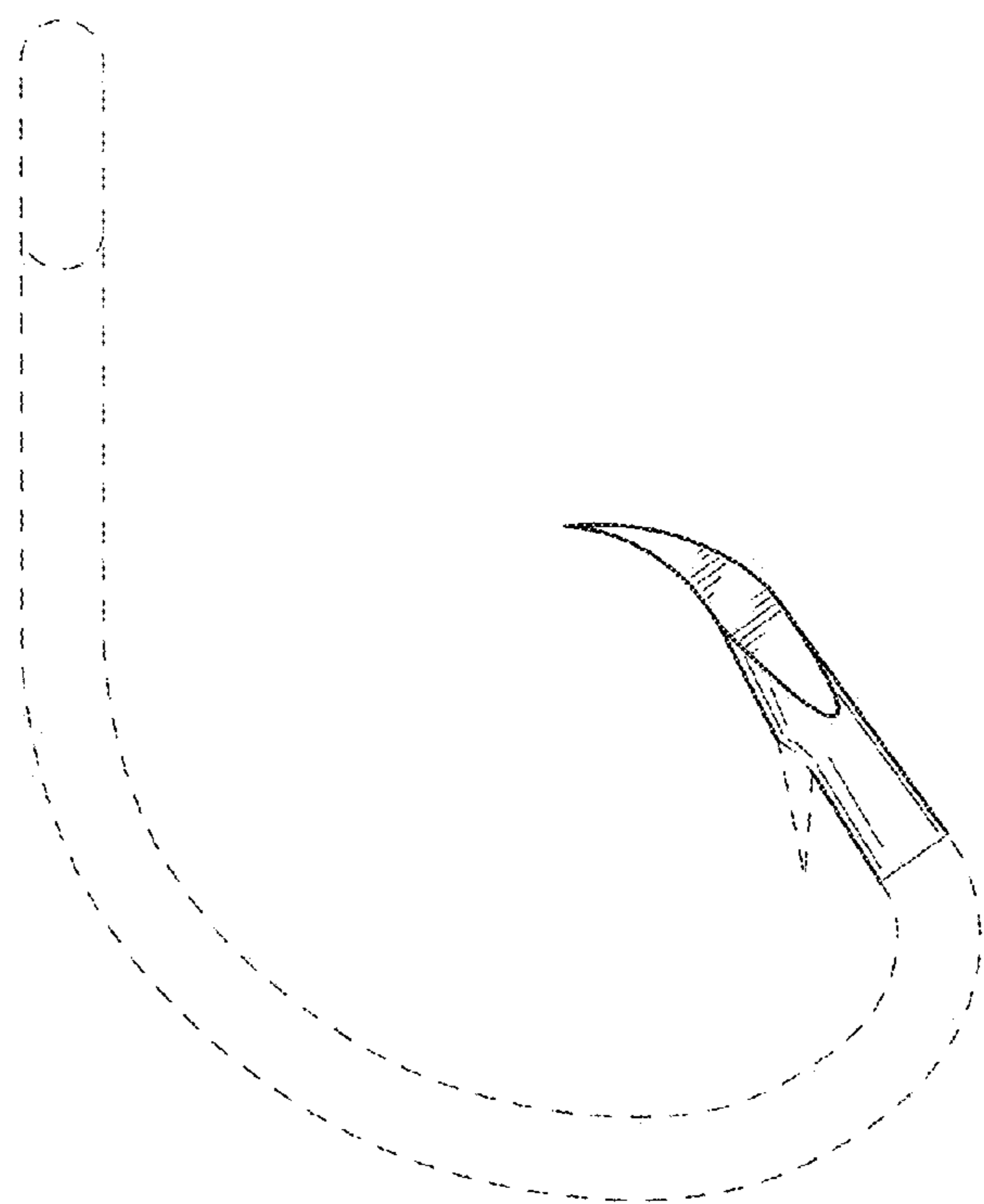

FIG. 3

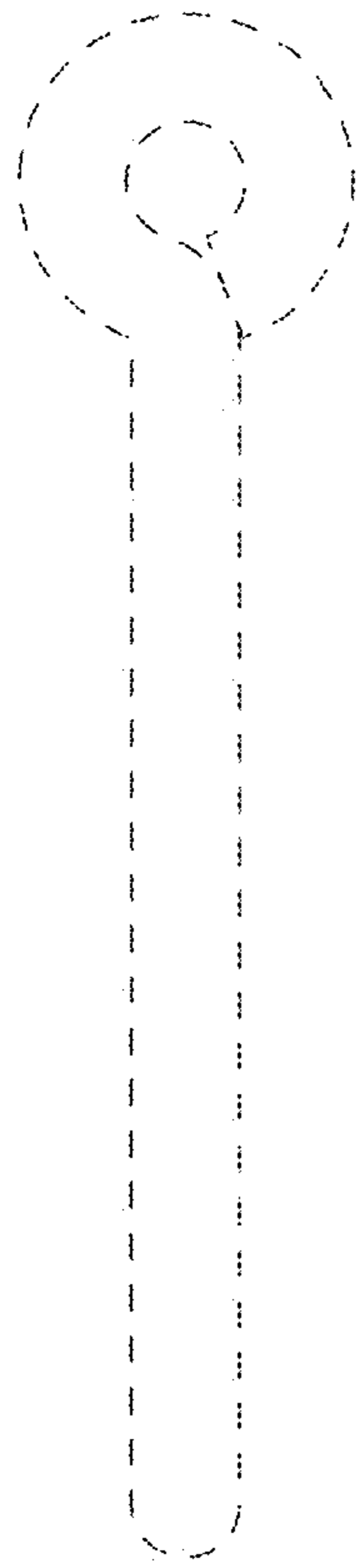

FIG.4

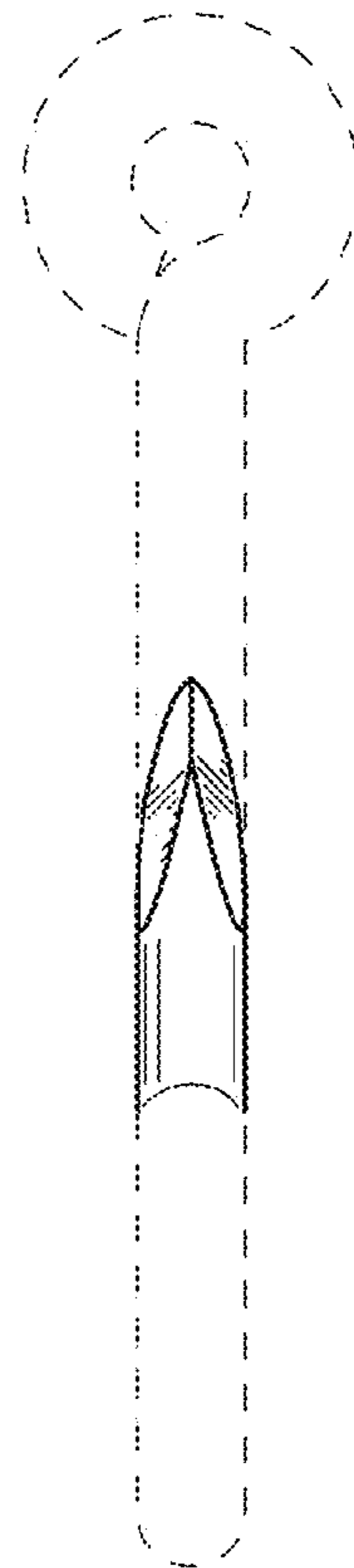

FIG.5

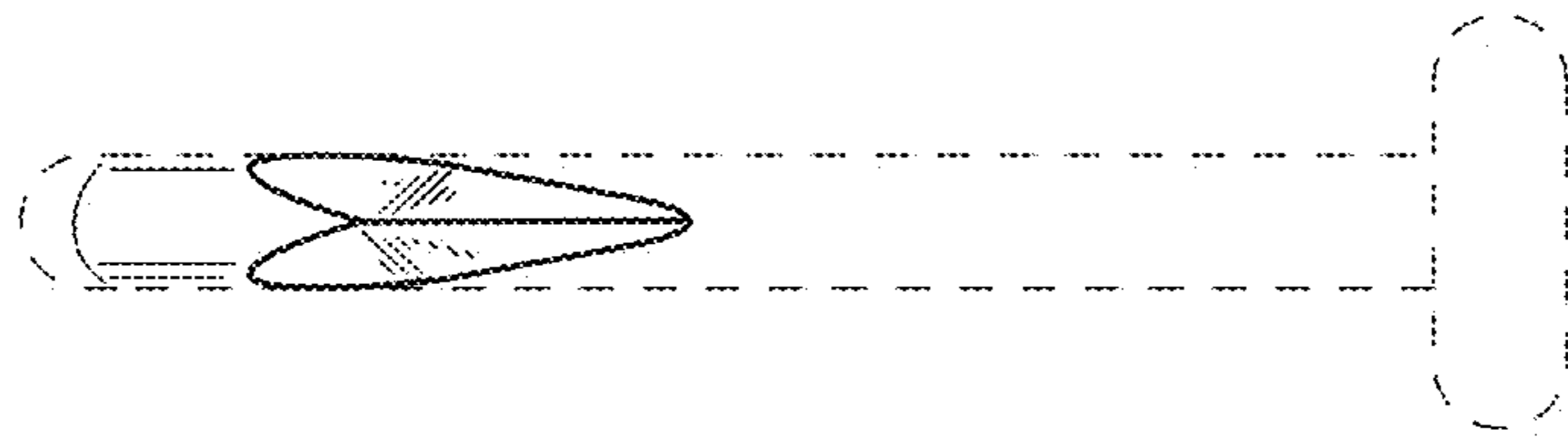

FIG. 6

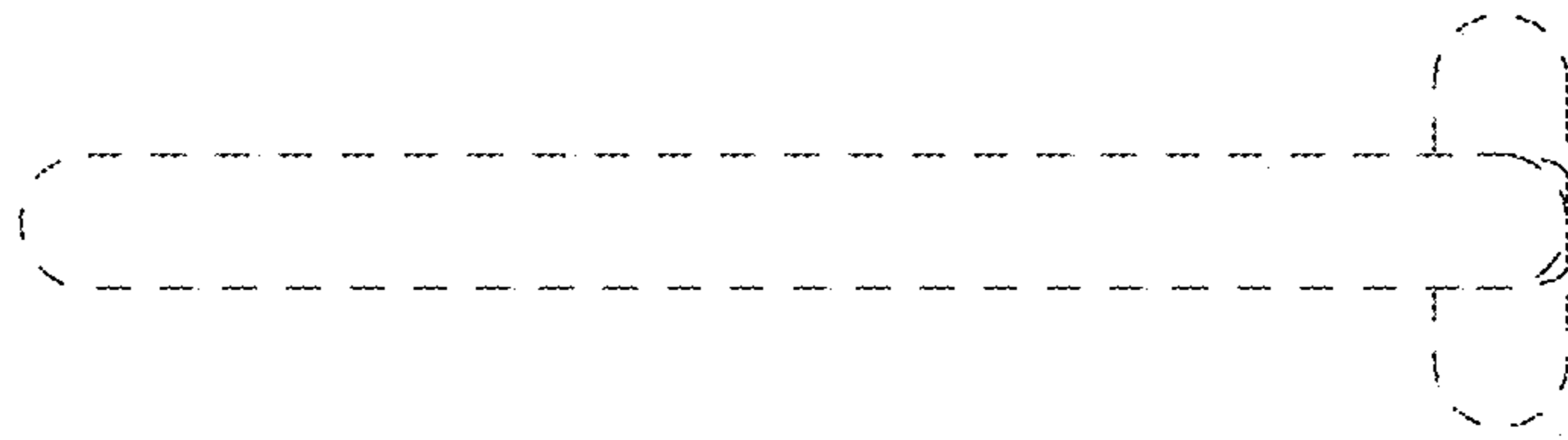

FIG. 7