



US00D746927S

(12) **United States Design Patent**
Parsons et al.

(10) **Patent No.:** **US D746,927 S**
(45) **Date of Patent:** **** Jan. 5, 2016**

(54) **GOLF CLUB HEAD**

U.S. Appl. No. 29/516,035, Nicolette, "Golf Club Head," filed Jan. 29, 2015.

(71) Applicant: **PARSONS XTREME GOLF, LLC**,
Scottsdale, AZ (US)

(Continued)

(72) Inventors: **Robert R. Parsons**, Scottsdale, AZ
(US); **Bradley D. Schweigert**, Anthem,
AZ (US); **Michael R. Nicolette**,
Scottsdale, AZ (US)

Primary Examiner — Mitchell Siegel

(73) Assignee: **PARSONS XTREME GOLF, LLC**,
Scottsdale, AZ (US)

(57) **CLAIM**
The ornamental design for a golf club head, as shown and described.

(**) Term: **15 Years**

DESCRIPTION

(21) Appl. No.: **29/537,455**

(22) Filed: **Aug. 26, 2015**

Related U.S. Application Data

(63) Continuation-in-part of application No. 29/533,540,
filed on Jul. 17, 2015.

(51) **LOC (10) Cl.** **21-02**

(52) **U.S. Cl.**
USPC **D21/752**

(58) **Field of Classification Search**
USPC D21/733, 752, 759
CPC A63B 53/00; A63B 53/04; A63B 53/0466;
A63B 2053/002; A63B 2053/0404; A63B
2053/0433

See application file for complete search history.

(56) **References Cited**

U.S. PATENT DOCUMENTS

1,269,745 A * 6/1918 Robertson 473/344
D55,867 S 7/1920 Mattern

(Continued)

OTHER PUBLICATIONS

U.S. Appl. No. 29/509,088, Schweigert et al., "Golf Club Head," filed
Nov. 13, 2014.

FIG. 1 is a top perspective view of a golf club head;
FIG. 2 is a bottom perspective view of the golf club head of
FIG. 1;
FIG. 3 is a front elevational view of the golf club head of FIG.
1;
FIG. 4 is a rear elevational view of the golf club head of FIG.
1;
FIG. 5 is a top view of the golf club head of FIG. 1;
FIG. 6 is a bottom view of the golf club head of FIG. 1;
FIG. 7 is a left side view of the golf club head of FIG. 1;
FIG. 8 is a right side view of the golf club head of FIG. 1;
FIG. 9 is a top perspective view of a second embodiment of
the golf club head;
FIG. 10 is a bottom perspective view of the golf club head of
FIG. 9;
FIG. 11 is a front elevational view of the golf club head of
FIG. 9;
FIG. 12 is a rear elevational view of the golf club head of FIG.
9;
FIG. 13 is a top view of the golf club head of FIG. 9;
FIG. 14 is a bottom view of the golf club head of FIG. 9;
FIG. 15 is a left side view of the golf club head of FIG. 9; and,
FIG. 16 is a right side view of the golf club head of FIG. 9.
The broken lines connecting the solid lines represent the
bounds of the claim. The remaining broken lines illustrate the
environment. None of the broken lines forms part of the
claimed design.

1 Claim, 16 Drawing Sheets

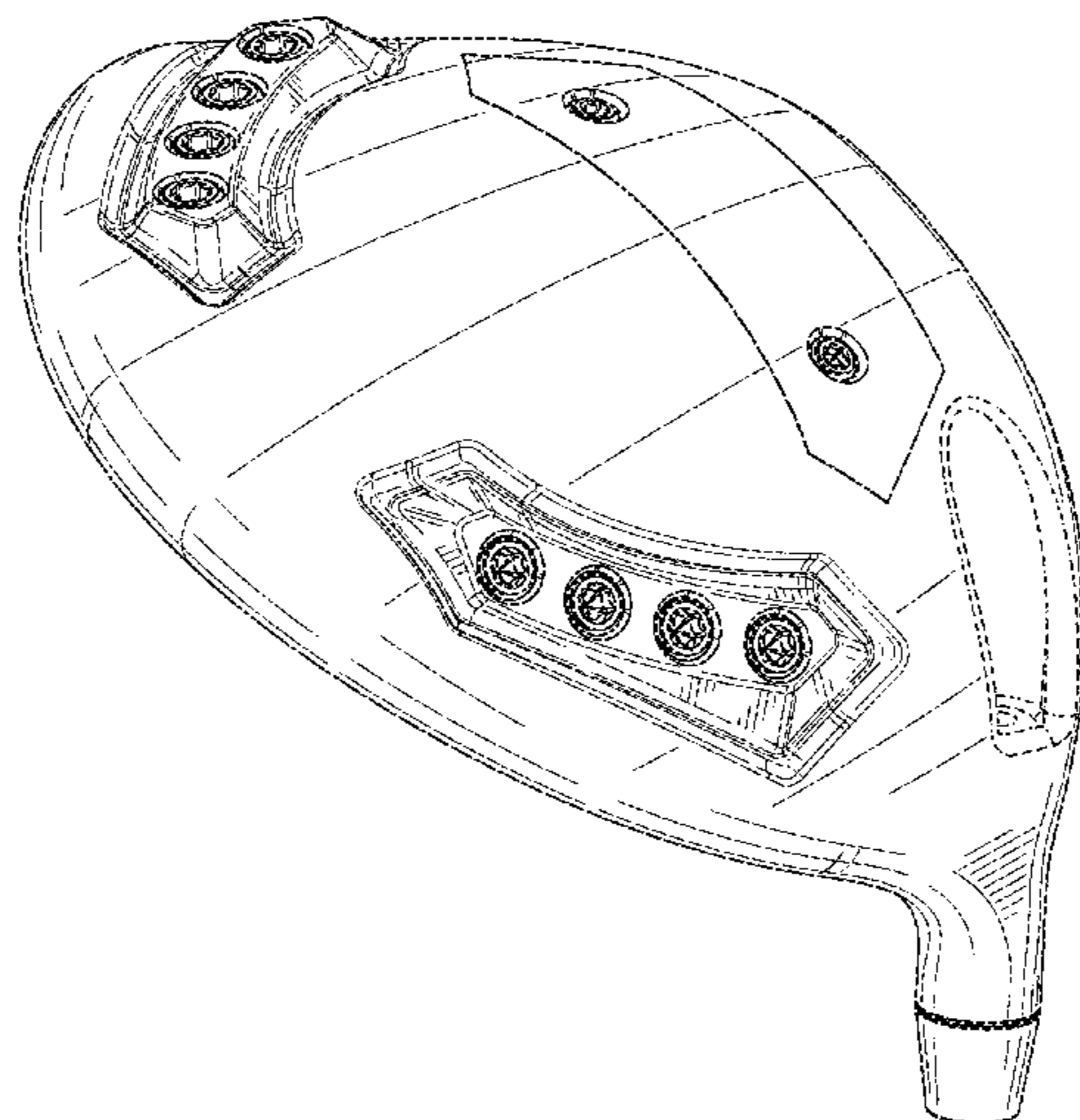

(56)

References Cited

U.S. PATENT DOCUMENTS

1,543,691	A *	6/1925	Beat	473/342	D594,521	S	6/2009	Jertson et al.
D138,437	S *	8/1944	Link	D21/752	D594,919	S	6/2009	Schweigert et al.
D138,438	S *	8/1944	Link	D21/752	7,540,811	B2	6/2009	Beach et al.
D138,439	S *	8/1944	Link	D21/752	D597,620	S	8/2009	Taylor et al.
D138,441	S *	8/1944	Link	D21/752	7,568,985	B2	8/2009	Beach et al.
D138,442	S *	8/1944	Link	D21/752	7,578,753	B2	8/2009	Beach et al.
D185,177	S *	5/1959	Smith	D21/752	D600,297	S	9/2009	Jertson et al.
D229,431	S *	11/1973	Baker	D21/752	7,584,531	B2	9/2009	Schweigert et al.
D253,778	S *	12/1979	Madison	D21/752	7,591,738	B2	9/2009	Beach et al.
4,332,388	A *	6/1982	Crow	473/328	D603,472	S	11/2009	Schweigert et al.
D307,783	S	5/1990	Iinuma		7,611,424	B2	11/2009	Nagai et al.
D326,885	S	6/1992	Paul		7,621,823	B2	11/2009	Beach et al.
5,213,329	A *	5/1993	Okumoto et al.	473/328	D605,715	S	12/2009	Barez et al.
D344,561	S	2/1994	Gorman		7,632,194	B2	12/2009	Beach et al.
D351,883	S *	10/1994	Solheim et al.	D21/752	7,713,142	B2	5/2010	Hoffman et al.
5,518,243	A	5/1996	Redman		7,717,804	B2	5/2010	Beach et al.
D371,816	S *	7/1996	Yoshioka	D21/752	7,717,805	B2	5/2010	Beach et al.
D378,111	S *	2/1997	Parente et al.	D21/752	D618,746	S	6/2010	Jertson et al.
D384,120	S *	9/1997	De La Cruz et al.	D21/752	D618,747	S	6/2010	Schweigert et al.
5,788,584	A	8/1998	Parente et al.		D618,753	S	6/2010	Jertson et al.
D400,625	S	11/1998	Kubica et al.		D618,754	S	6/2010	Schweigert et al.
D400,627	S	11/1998	Kubica et al.		7,744,484	B1	6/2010	Chao
D405,489	S	2/1999	Kubica et al.		7,798,203	B2	9/2010	Schweigert et al.
D405,492	S	2/1999	Kubica et al.		7,846,041	B2	12/2010	Beach et al.
D444,830	S	7/2001	Kubica et al.		D635,626	S	4/2011	Nicolette
D448,824	S	10/2001	Koizumi et al.		7,927,229	B2	4/2011	Jertson et al.
D478,140	S	8/2003	Burrows		D638,893	S	5/2011	Schweigert et al.
D481,087	S	10/2003	Antonious		D638,896	S	5/2011	Schweigert et al.
6,773,360	B2	8/2004	Willett et al.		7,963,861	B2	6/2011	Beach et al.
6,939,247	B1	9/2005	Schweigert et al.		D647,585	S	10/2011	Jertson et al.
D513,051	S	12/2005	Barez et al.		D661,751	S	6/2012	Nicolette et al.
D514,179	S	1/2006	Chen et al.		D661,756	S	6/2012	Nicolette et al.
D514,185	S	1/2006	Barez et al.		8,257,196	B1	9/2012	Abbott et al.
D520,586	S *	5/2006	Bingman	D21/759	8,262,506	B2	9/2012	Watson et al.
D522,077	S	5/2006	Schweigert et al.		D673,630	S	1/2013	Schweigert
D522,601	S	6/2006	Schweigert et al.		D673,632	S	1/2013	Schweigert et al.
D523,498	S	6/2006	Chen et al.		8,371,957	B2	2/2013	Schweigert et al.
D526,694	S	8/2006	Schweigert et al.		D680,179	S	4/2013	Solheim et al.
D534,599	S	1/2007	Barez et al.		8,414,422	B2	4/2013	Peralta et al.
7,166,040	B2	1/2007	Hoffman et al.		D689,156	S	9/2013	Stokke et al.
D536,401	S *	2/2007	Kawami	D21/759	D691,230	S	10/2013	Chen et al.
D536,403	S *	2/2007	Kawami	D21/759	8,562,457	B2	10/2013	Beach et al.
D537,495	S	2/2007	Schweigert et al.		8,608,587	B2	12/2013	Henrikson et al.
D538,363	S	3/2007	Schweigert et al.		8,628,431	B2	1/2014	Schweigert et al.
D538,371	S *	3/2007	Kawami	D21/759	8,777,778	B2	7/2014	Solheim et al.
7,186,190	B1	3/2007	Beach et al.		8,784,232	B2	7/2014	Jertson et al.
7,223,180	B2	5/2007	Willett et al.		8,790,196	B2	7/2014	Solheim et al.
D552,198	S	10/2007	Schweigert et al.		8,808,108	B2	8/2014	Schweigert
D557,363	S *	12/2007	Jertson et al.	D21/752	D712,989	S	9/2014	Gillig
D558,287	S	12/2007	Jertson et al.		8,826,512	B2	9/2014	Schweigert
D558,288	S	12/2007	Jertson et al.		D714,894	S *	10/2014	Tang et al. D21/759
D562,421	S *	2/2008	Jertson et al.	D21/752	8,858,362	B1	10/2014	Leposky et al.
D564,055	S	3/2008	Jertson et al.		D721,544	S	1/2015	Hollander
7,338,388	B2	3/2008	Schweigert et al.		8,961,336	B1	2/2015	Parsons et al.
7,347,794	B2	3/2008	Schweigert		D724,164	S *	3/2015	Schweigert et al. D21/752
D567,317	S	4/2008	Jertson et al.		D729,892	S *	5/2015	Nicolette et al. D21/752
D569,935	S *	5/2008	Schweigert et al.	D21/752	D733,234	S *	6/2015	Nicolette D21/752
D569,936	S	5/2008	Schweigert et al.		2007/0293344	A1	12/2007	Davis
D569,942	S	5/2008	Jertson et al.		2008/0004133	A1	1/2008	Schweigert
D570,937	S	6/2008	Schweigert et al.		2009/0029795	A1	1/2009	Schweigert et al.
D570,938	S *	6/2008	Jertson et al.	D21/752	2010/0144461	A1	6/2010	Ban
7,407,447	B2	8/2008	Beach et al.		2011/0143858	A1	6/2011	Peralta et al.
7,410,425	B2	8/2008	Willett et al.		2012/0202615	A1	8/2012	Beach et al.
7,410,426	B2	8/2008	Willett et al.		2013/0303304	A1	11/2013	Sato
7,419,441	B2	9/2008	Hoffman et al.					
7,448,963	B2	11/2008	Beach et al.					
7,448,964	B2	11/2008	Schweigert et al.					
7,530,904	B2	5/2009	Beach et al.					
D594,520	S	6/2009	Schweigert et al.					

OTHER PUBLICATIONS

U.S. Appl. No. 29/516,817, Schweigert et al., "Golf Club Head," filed Feb. 6, 2015.

U.S. Appl. No. 29/507,474, Schweigert et al., "Golf Club Head," filed Oct. 28, 2014.

* cited by examiner

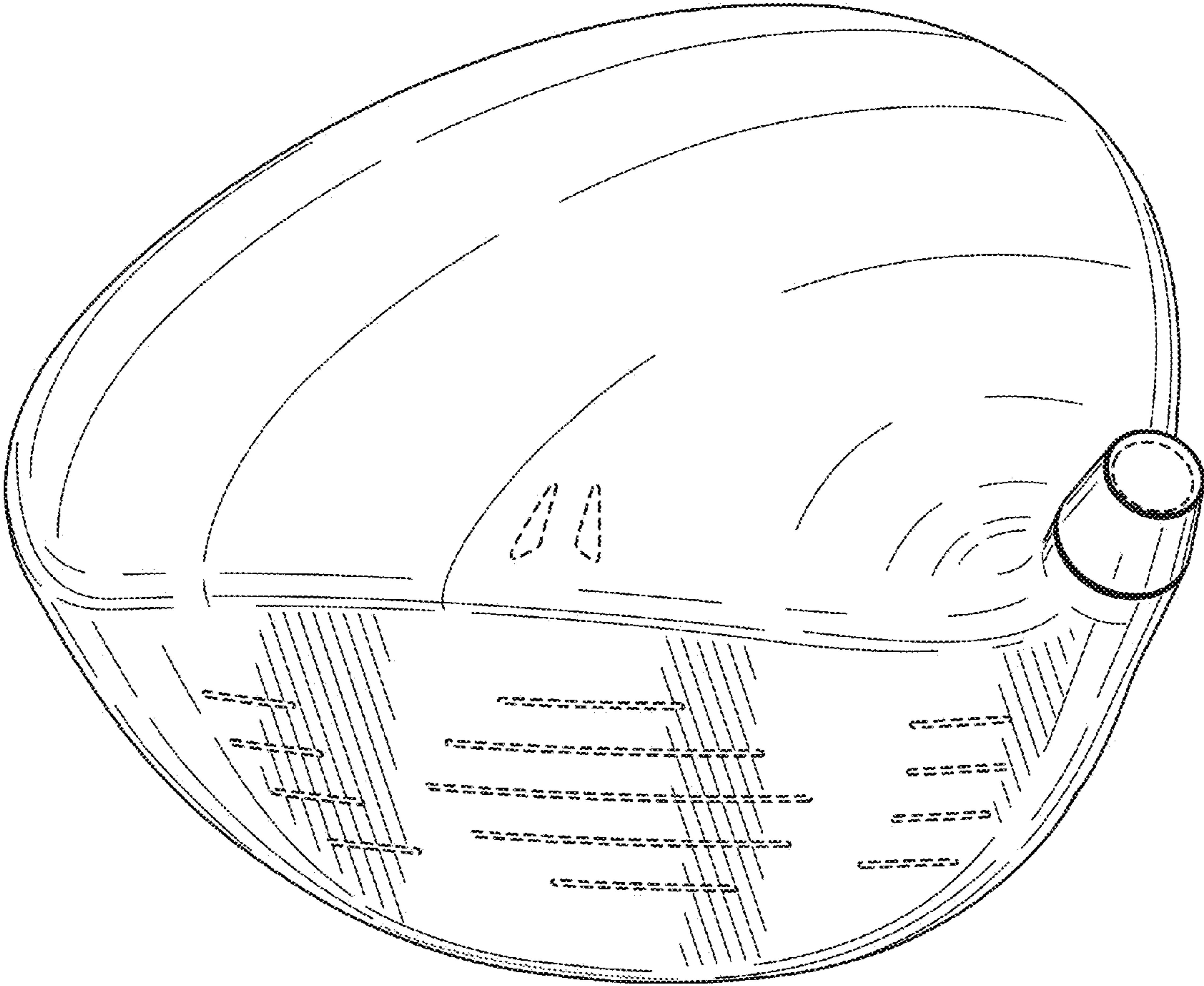

FIG. 1

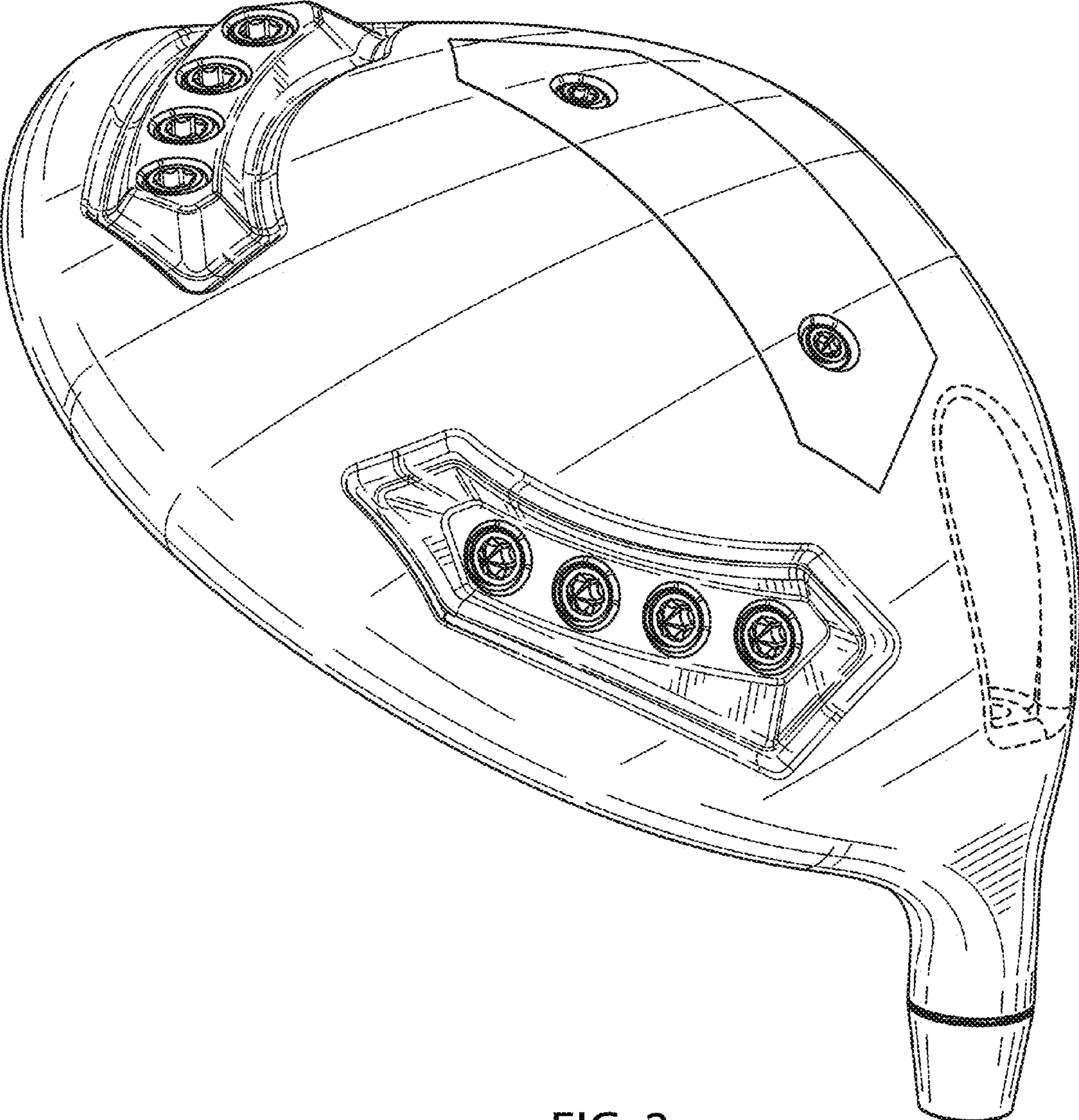

FIG. 2

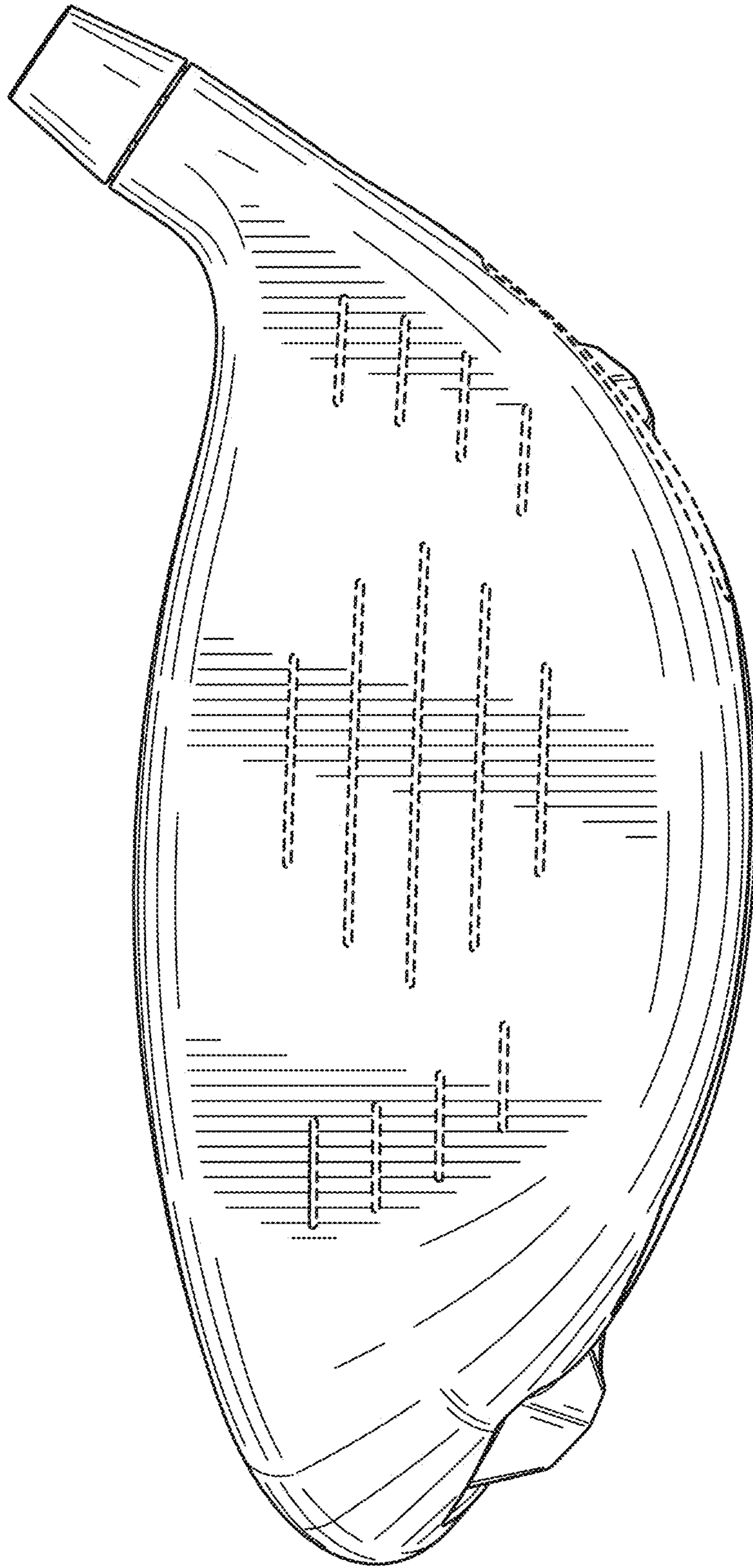

FIG. 3

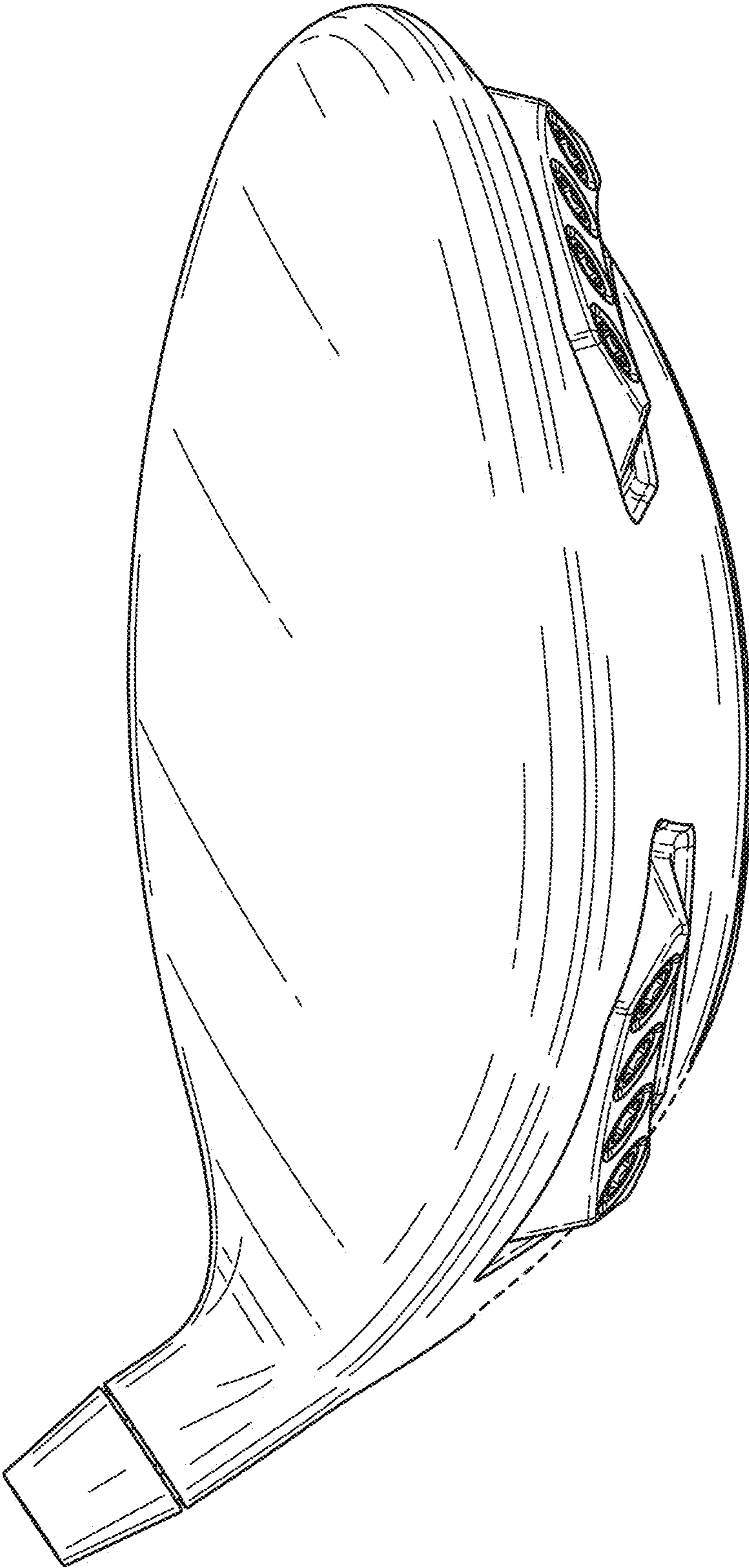

FIG. 4

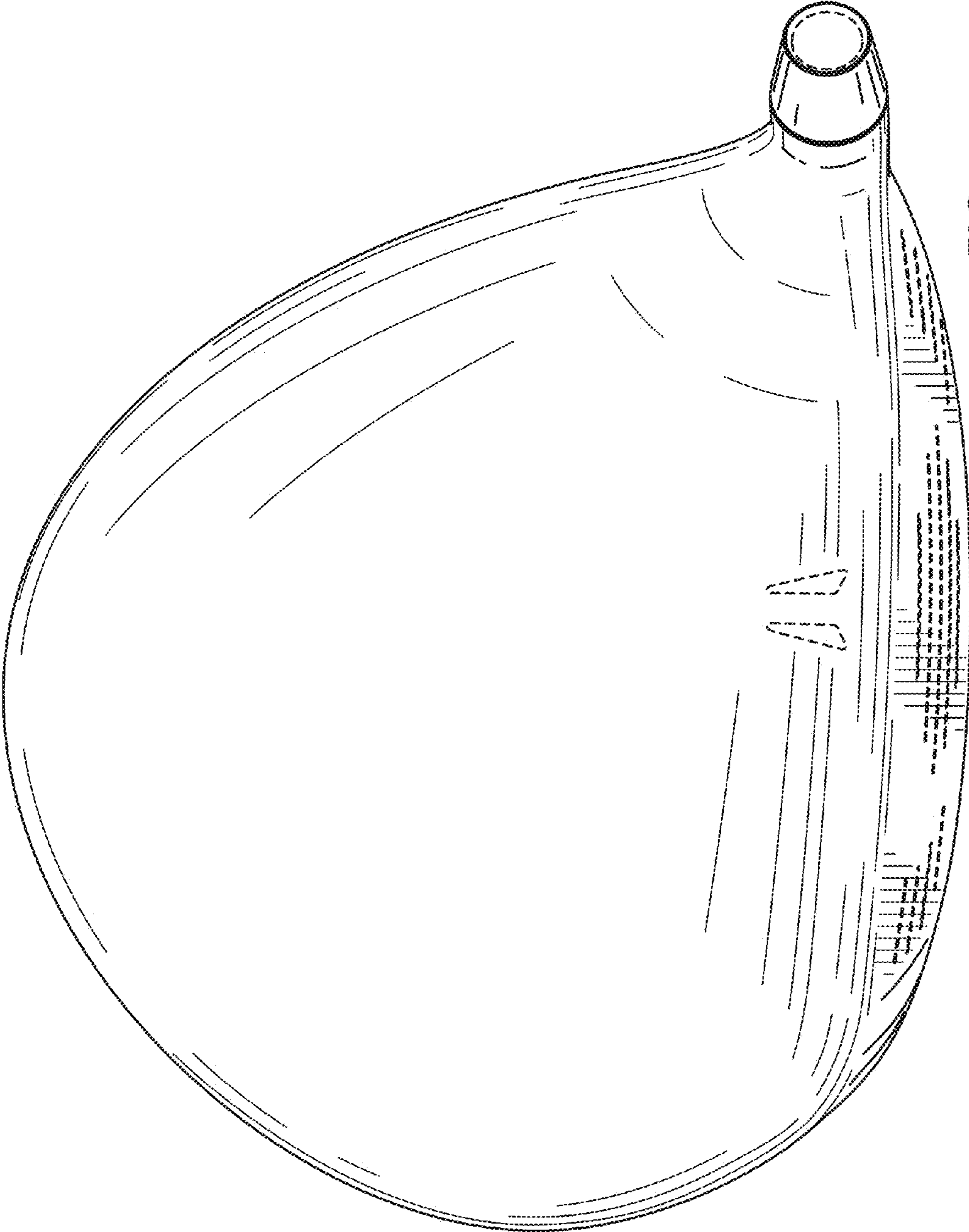

FIG. 5

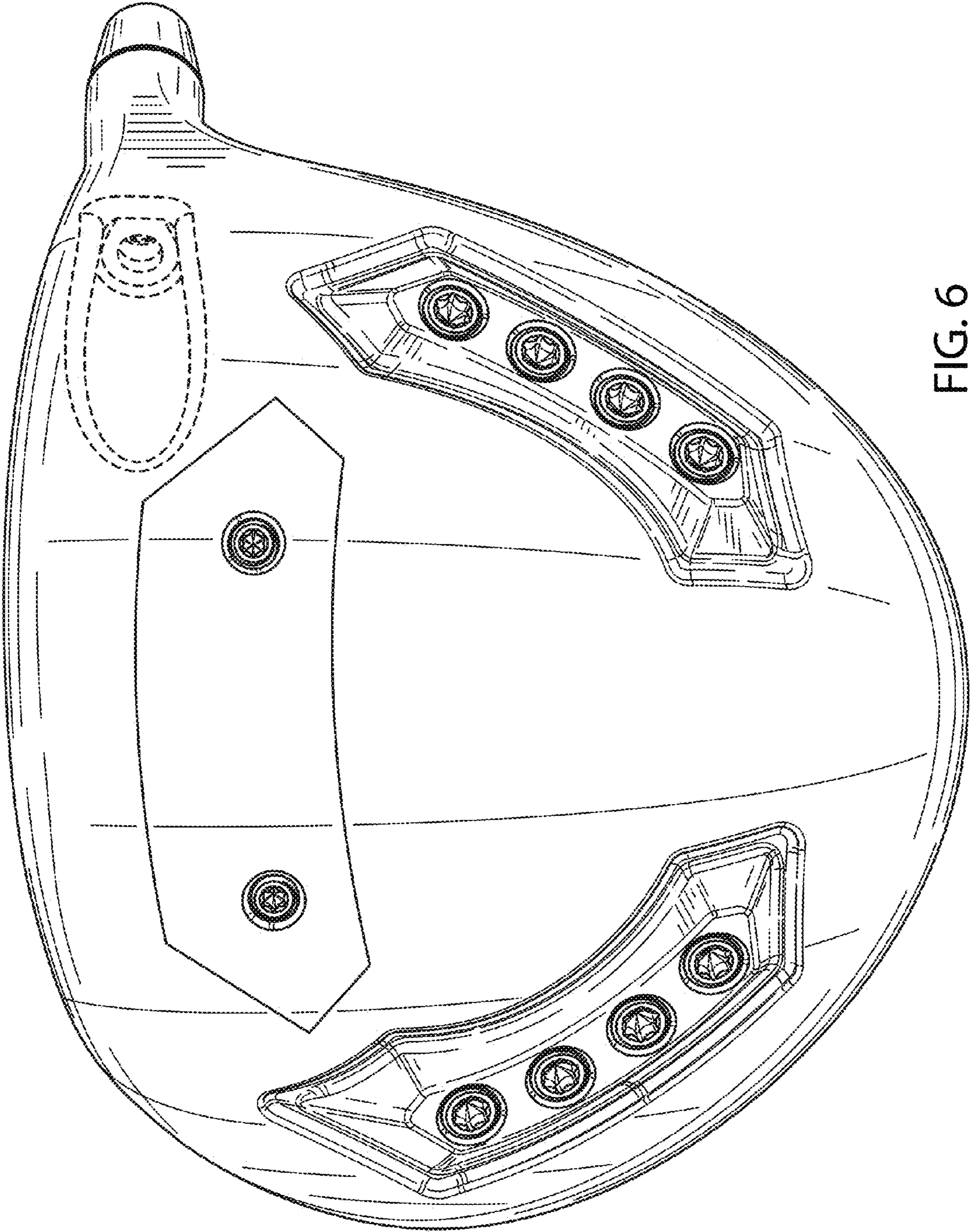

FIG. 6

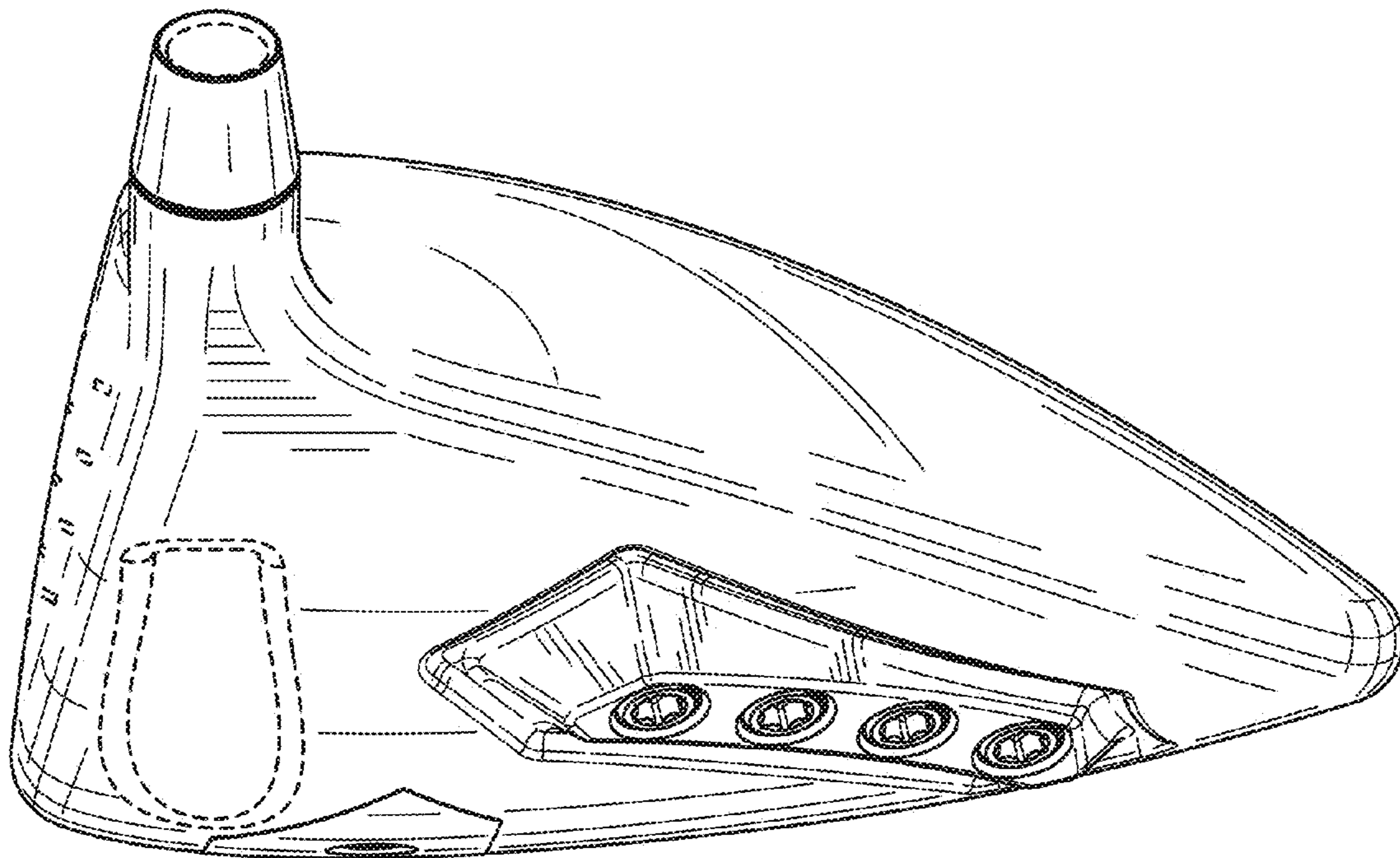

FIG. 7

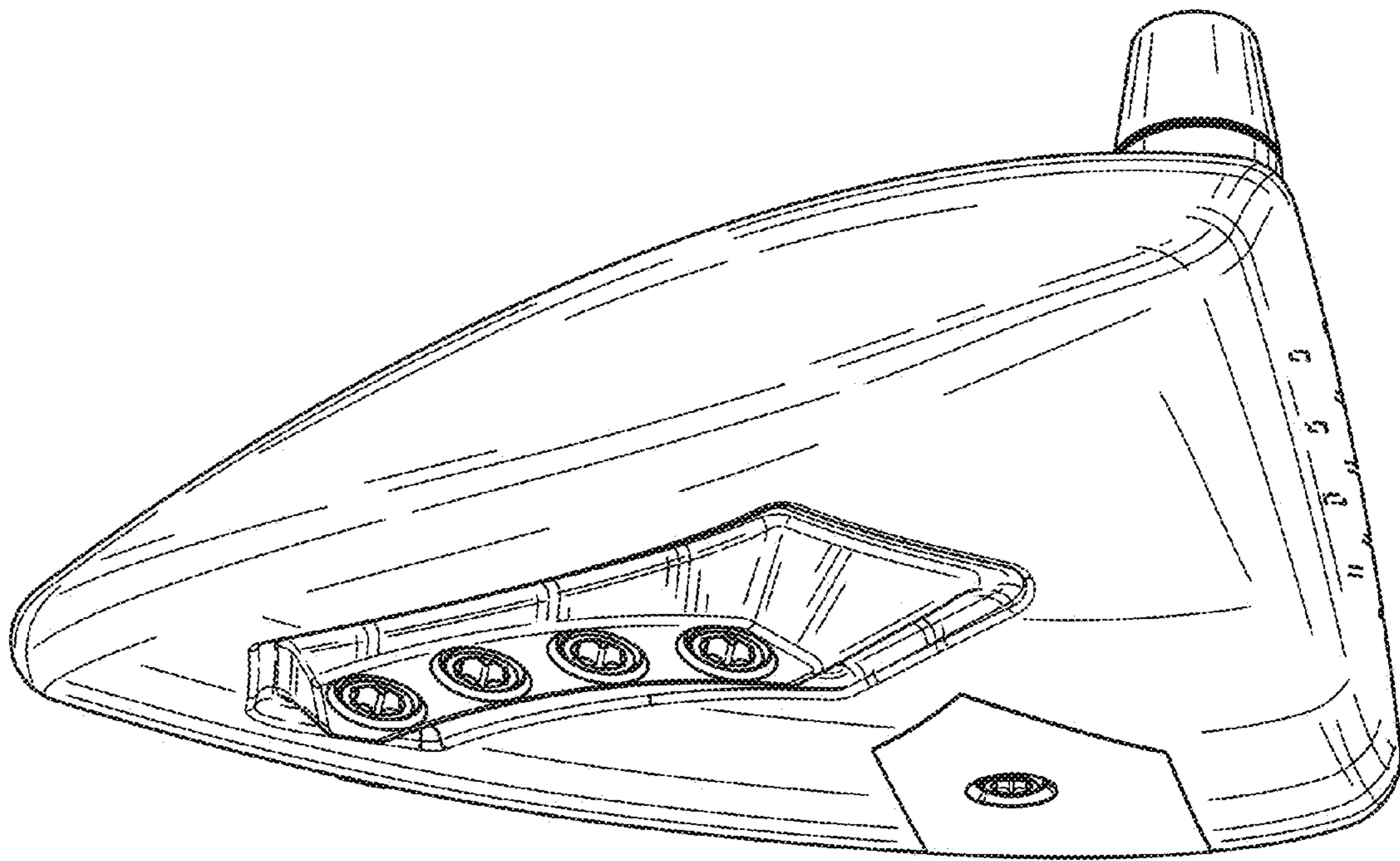

FIG. 8

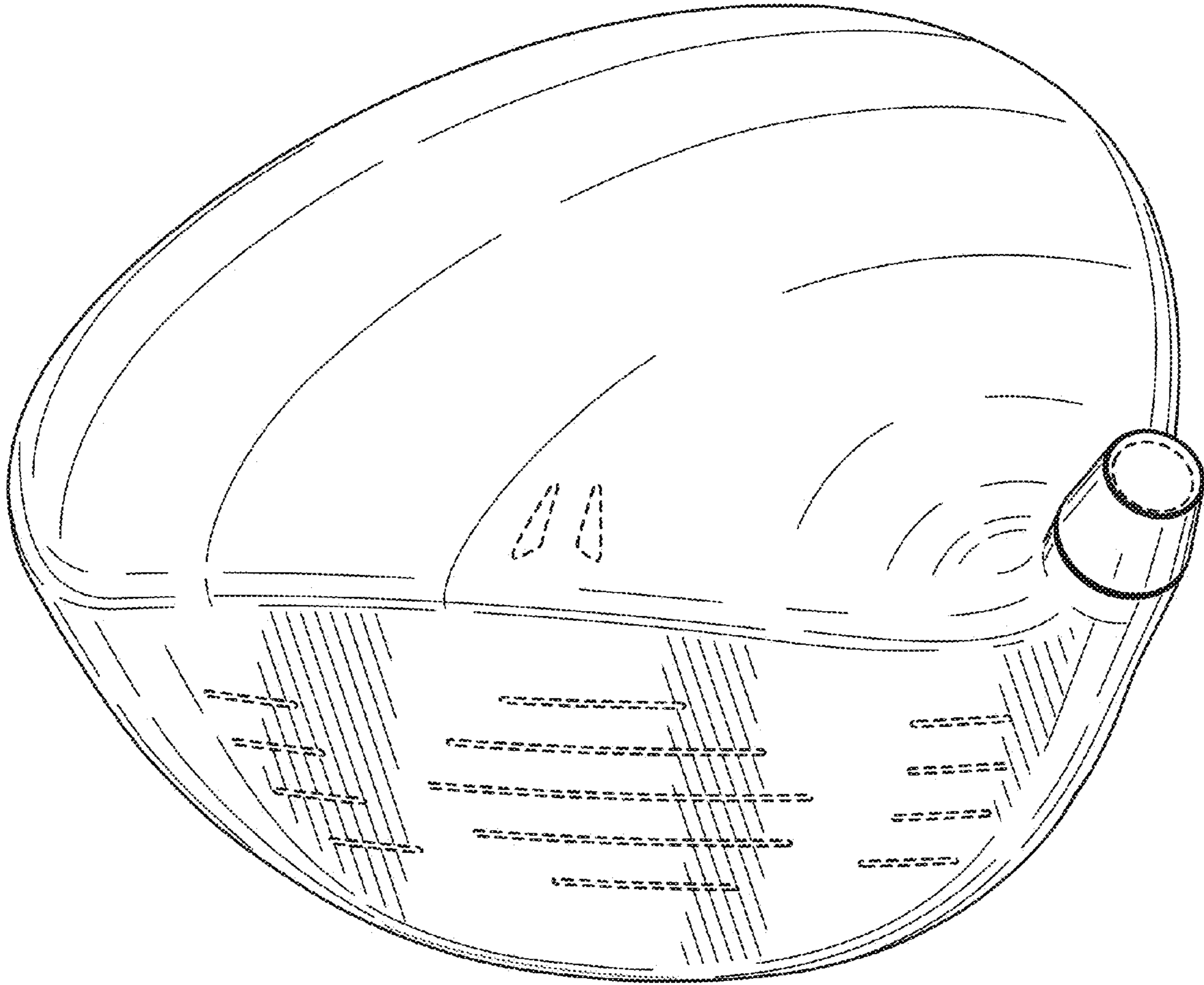

FIG. 9

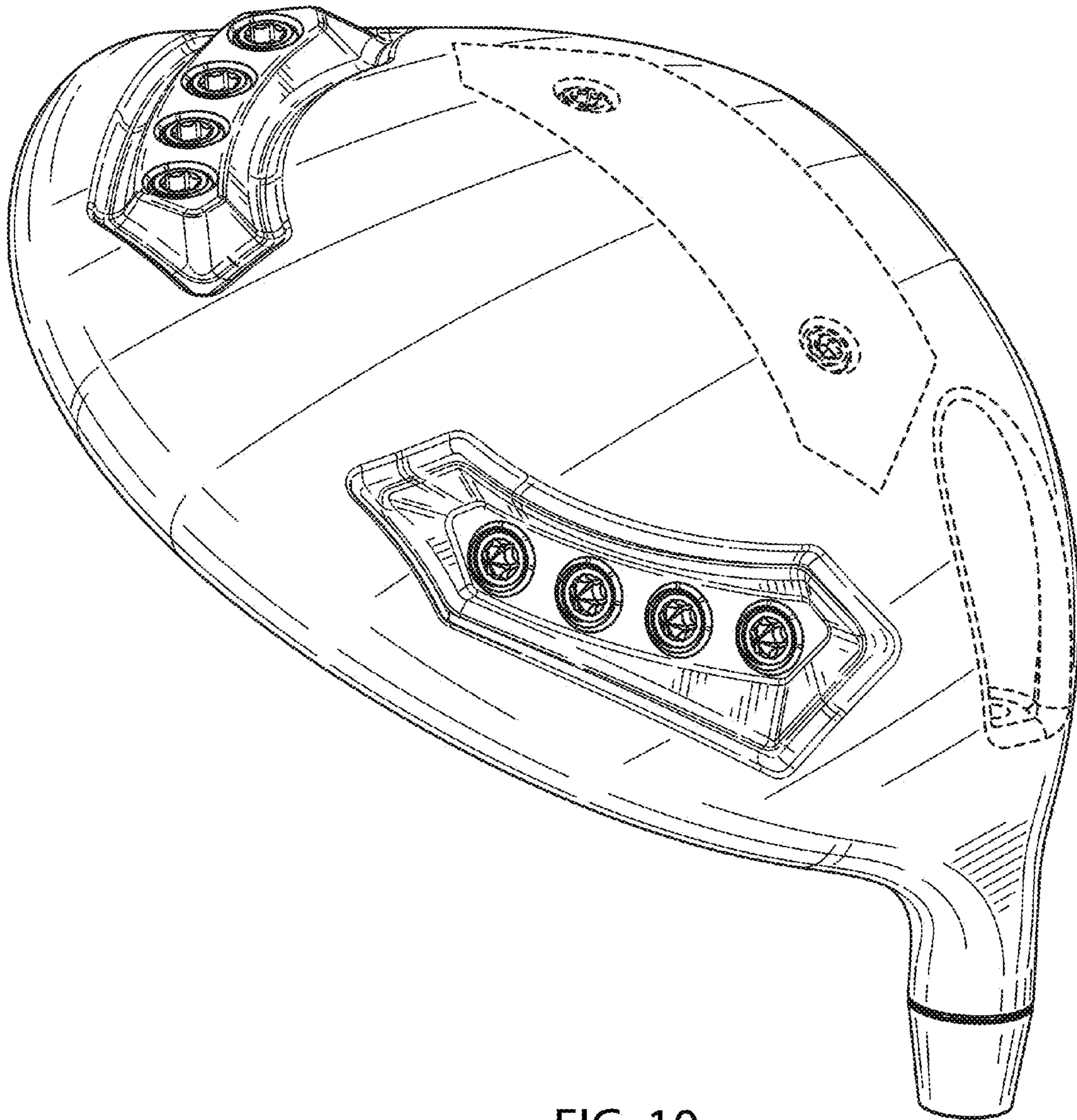

FIG. 10

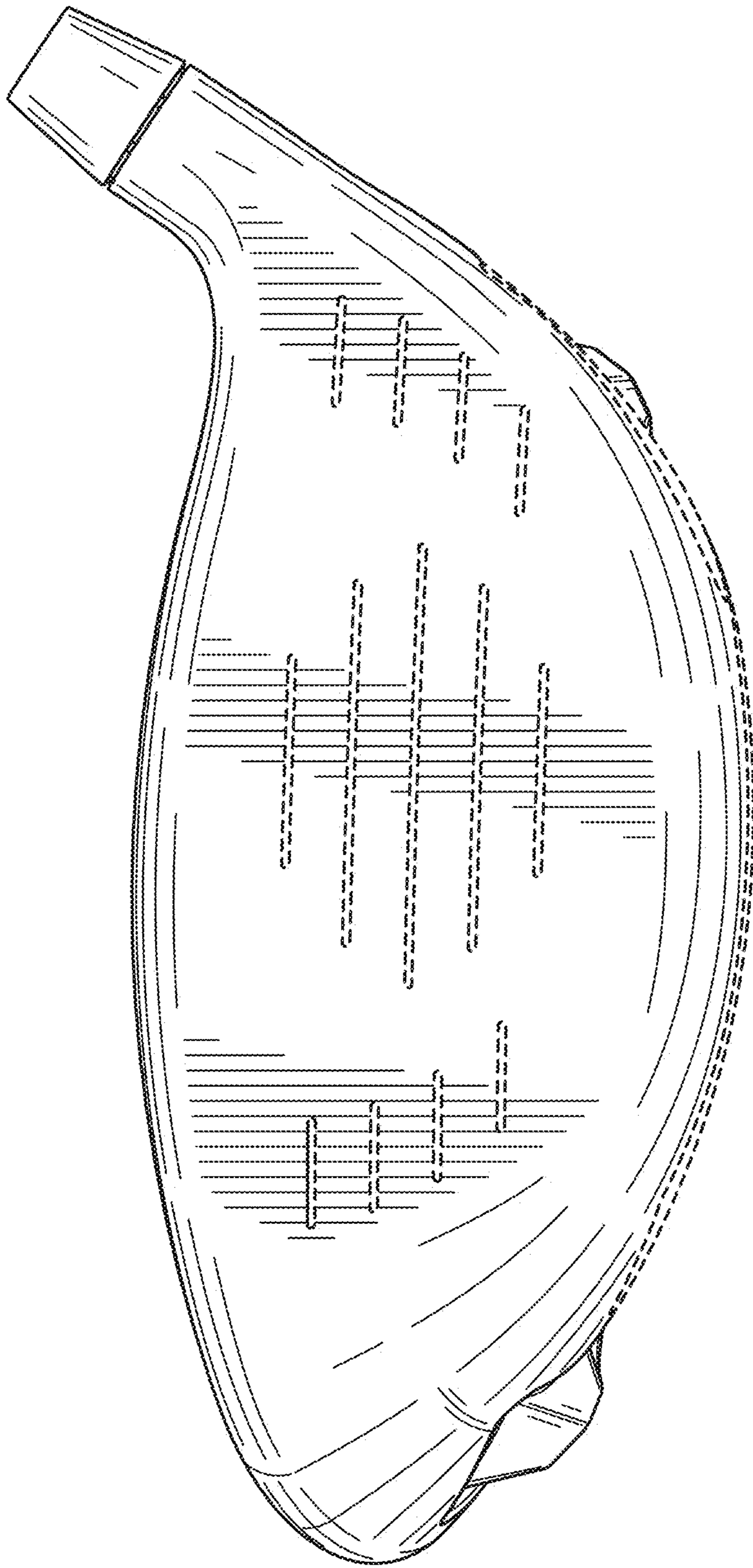

FIG. 11

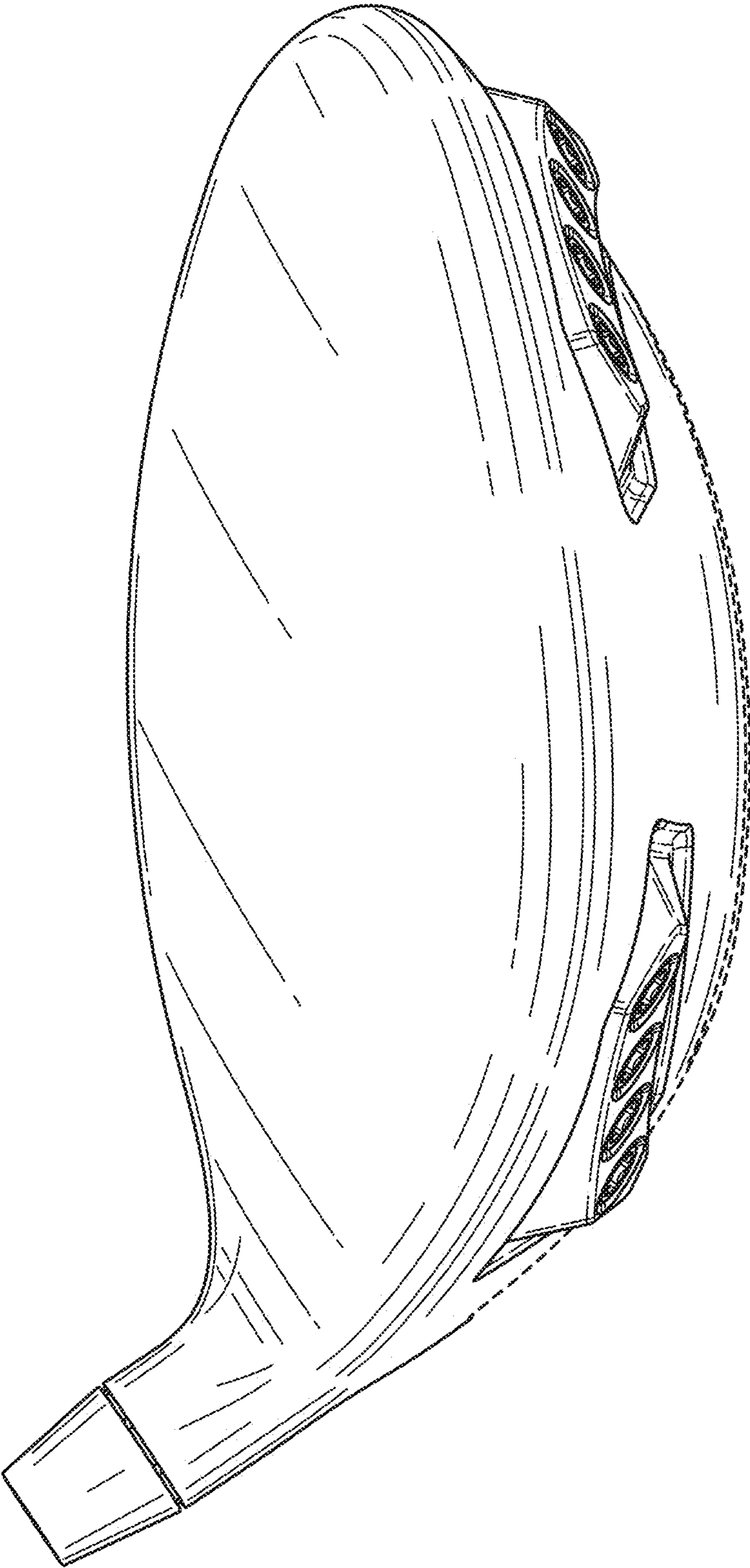

FIG. 12



FIG. 13

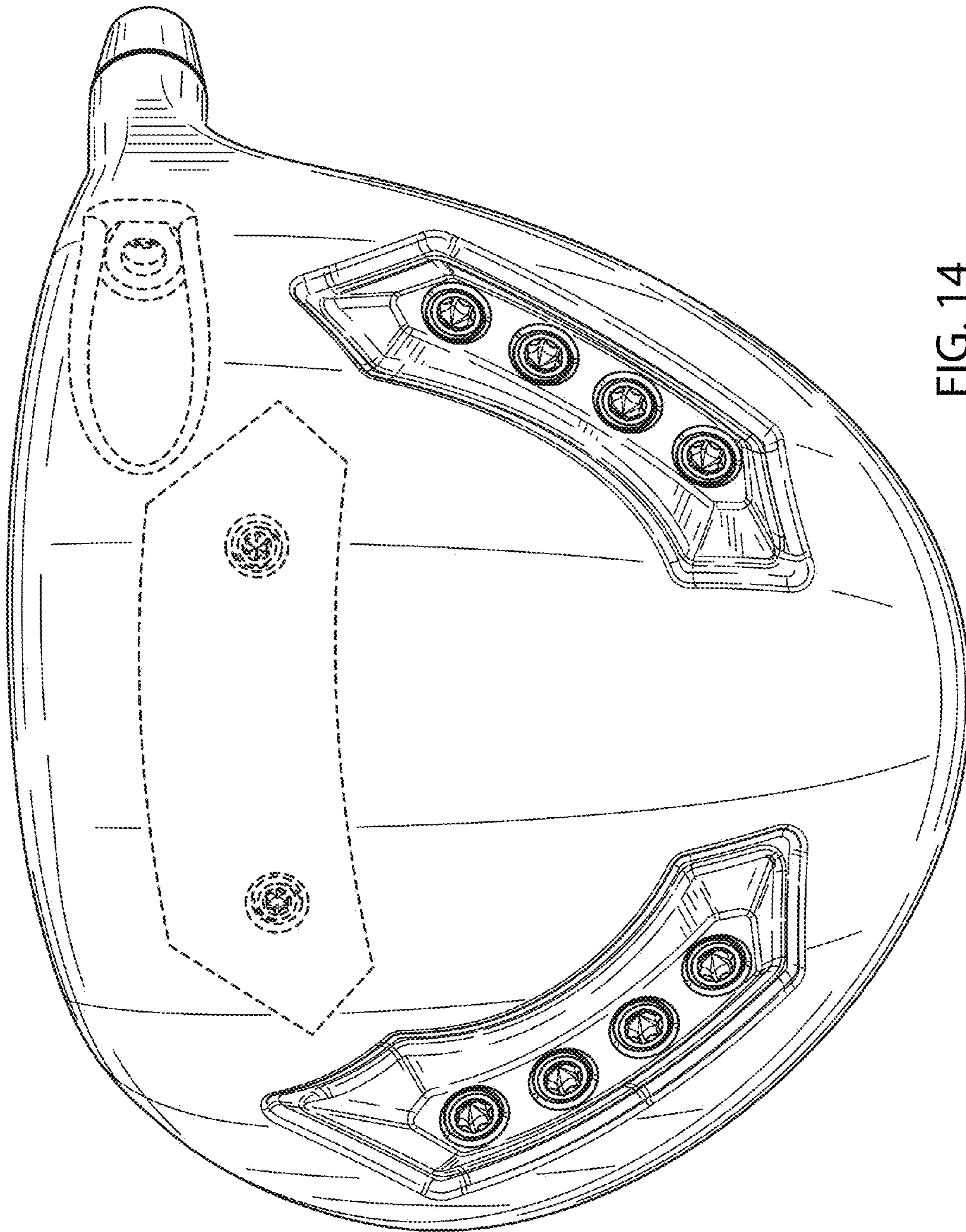

FIG. 14

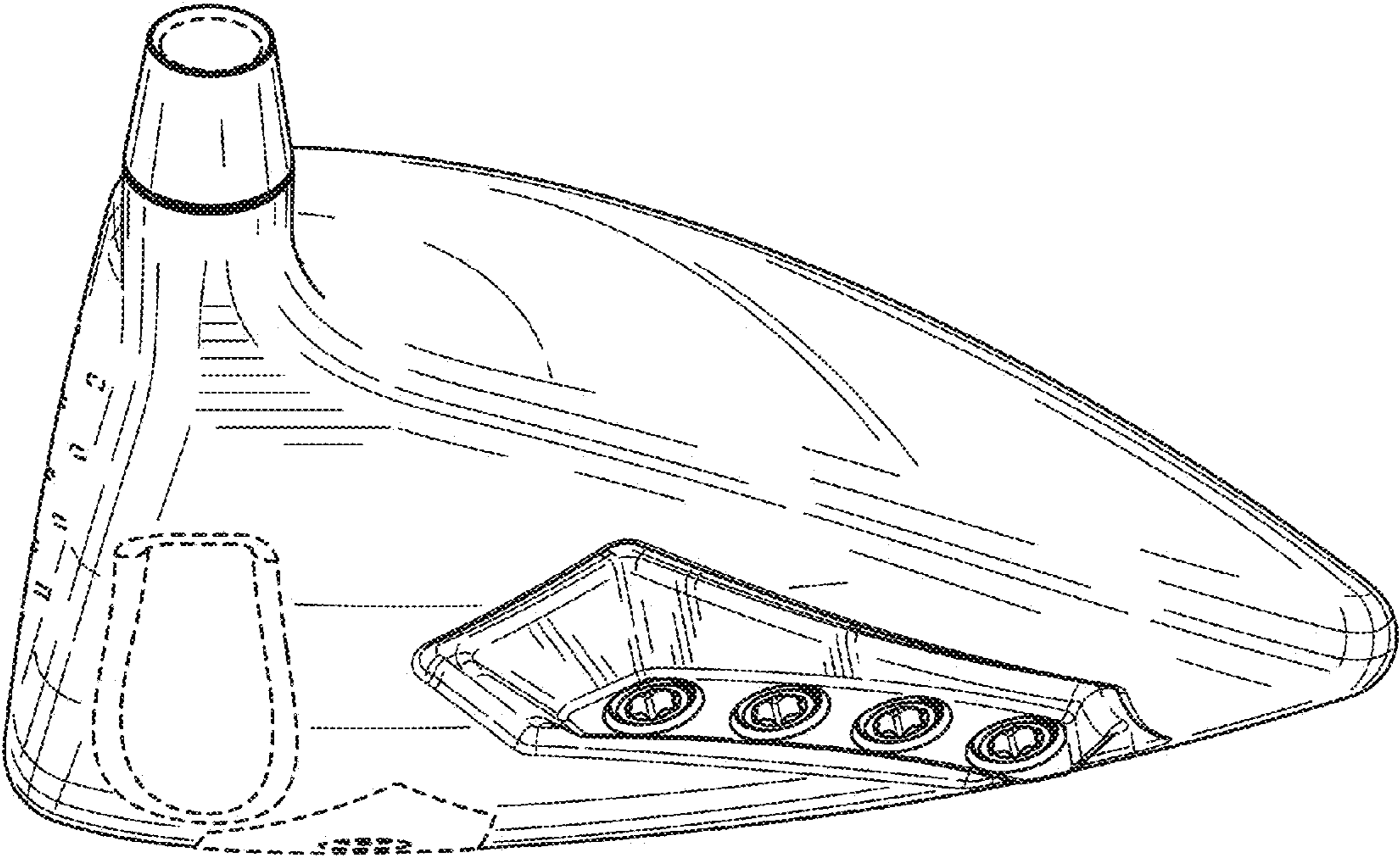

FIG. 15

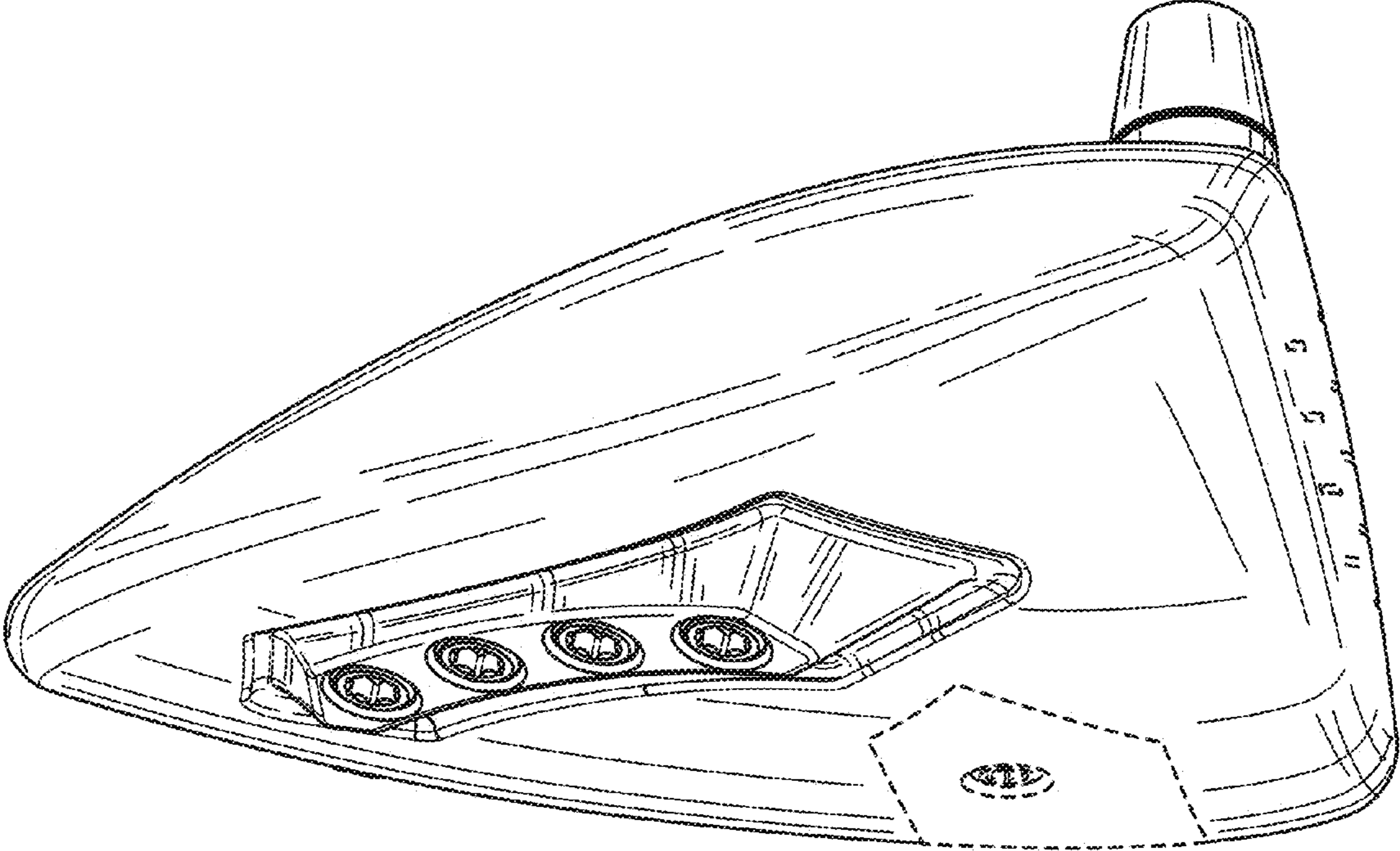

FIG. 16