



US00D746903S

(12) **United States Design Patent**
Kitagawa et al.

(10) **Patent No.:** **US D746,903 S**
(45) **Date of Patent:** **** Jan. 5, 2016**

(54) **TONER CARTRIDGE**

(71) Applicant: **KYOCERA Document Solutions Inc.,**
Osaka (JP)

(72) Inventors: **Hiroaki Kitagawa, Osaka (JP); Takashi**
Morita, Osaka (JP)

(73) Assignee: **KYOCERA Document Solutions Inc.,**
Osaka (JP)

(**) Term: **14 Years**

(21) Appl. No.: **29/504,666**

(22) Filed: **Oct. 8, 2014**

(30) **Foreign Application Priority Data**

Apr. 10, 2014 (JP) 2014-007889

(51) **LOC (10) Cl.** **16-03**

(52) **U.S. Cl.**
USPC **D18/43**

(58) **Field of Classification Search**
USPC D18/18, 40, 43, 56, 99
CPC G03G 15/0832; G03G 15/0834; G03G
15/0836; G03G 15/0837; G03G 15/0867;
G03G 15/0868; G03G 15/0872; G03G
15/0877; G03G 15/0898; G03G 15/50;
G03G 15/5016; G03G 15/60; G03G 15/65
See application file for complete search history.

(56) **References Cited**

U.S. PATENT DOCUMENTS

D723,099 S *	2/2015	Kubota	D18/43
D724,655 S *	3/2015	Kubota	D18/43
D736,309 S *	8/2015	Kang	D18/43
D736,310 S *	8/2015	Han	D18/43
D736,851 S *	8/2015	Kang	D18/43

* cited by examiner

Primary Examiner — Daniel Bui

Assistant Examiner — Khawaja Anwar

(74) *Attorney, Agent, or Firm* — Young & Thompson

(57) **CLAIM**

The ornamental design for a toner cartridge, as shown and described.

DESCRIPTION

FIG. 1 is a perspective view of front, left and top of toner cartridge showing our new design; FIG. 2 is a perspective view of rear, right and bottom thereof; FIG. 3 is a front view thereof; FIG. 4 is a rear view thereof; FIG. 5 is a left side view thereof; FIG. 6 is a right side view thereof; FIG. 7 is a top view thereof; and, FIG. 8 is a bottom view thereof.

The broken lines showing of the toner cartridge are included for the purpose of illustrating portions of the toner cartridge and form no part of the claimed design.

1 Claim, 5 Drawing Sheets

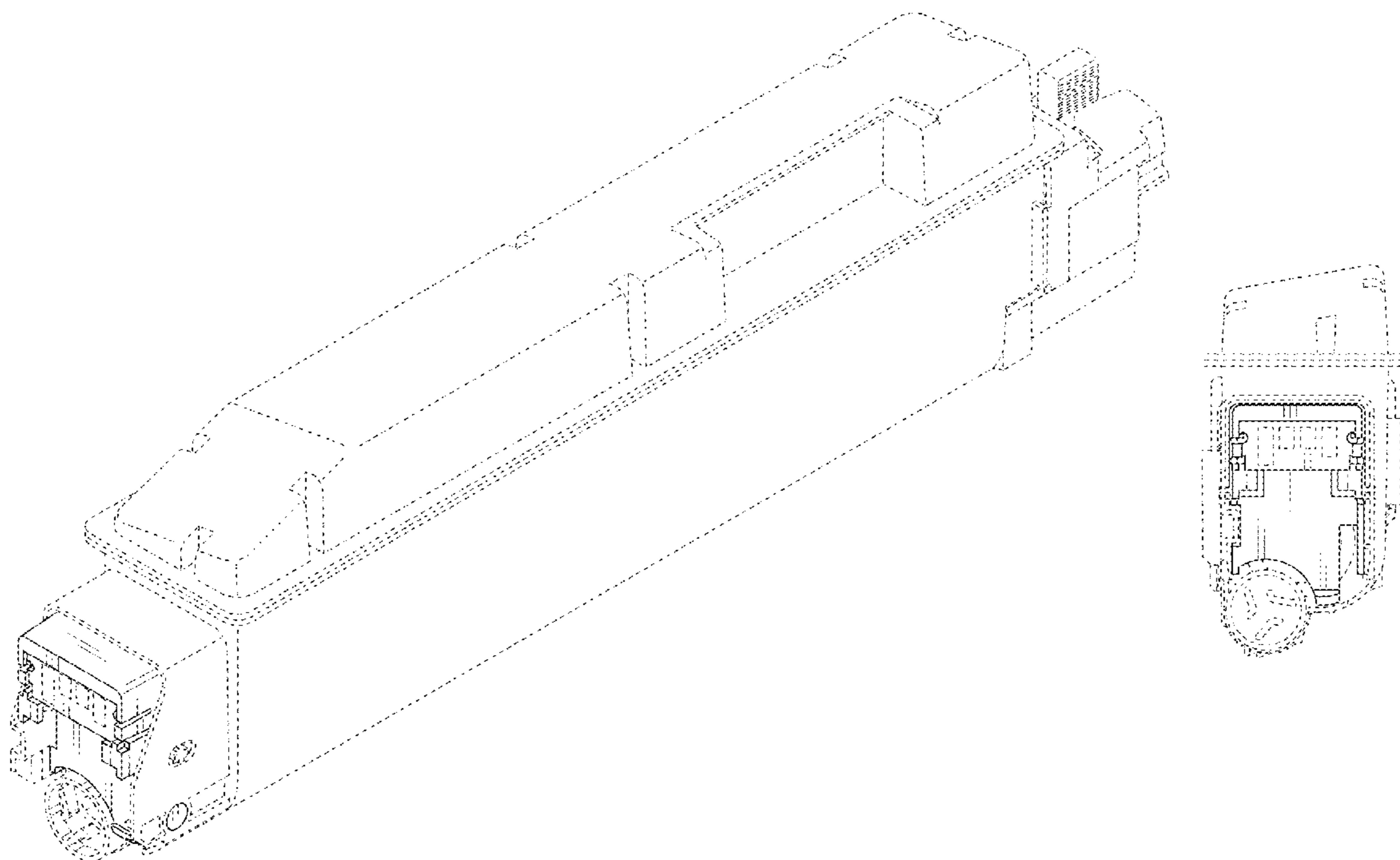

Fig. 1

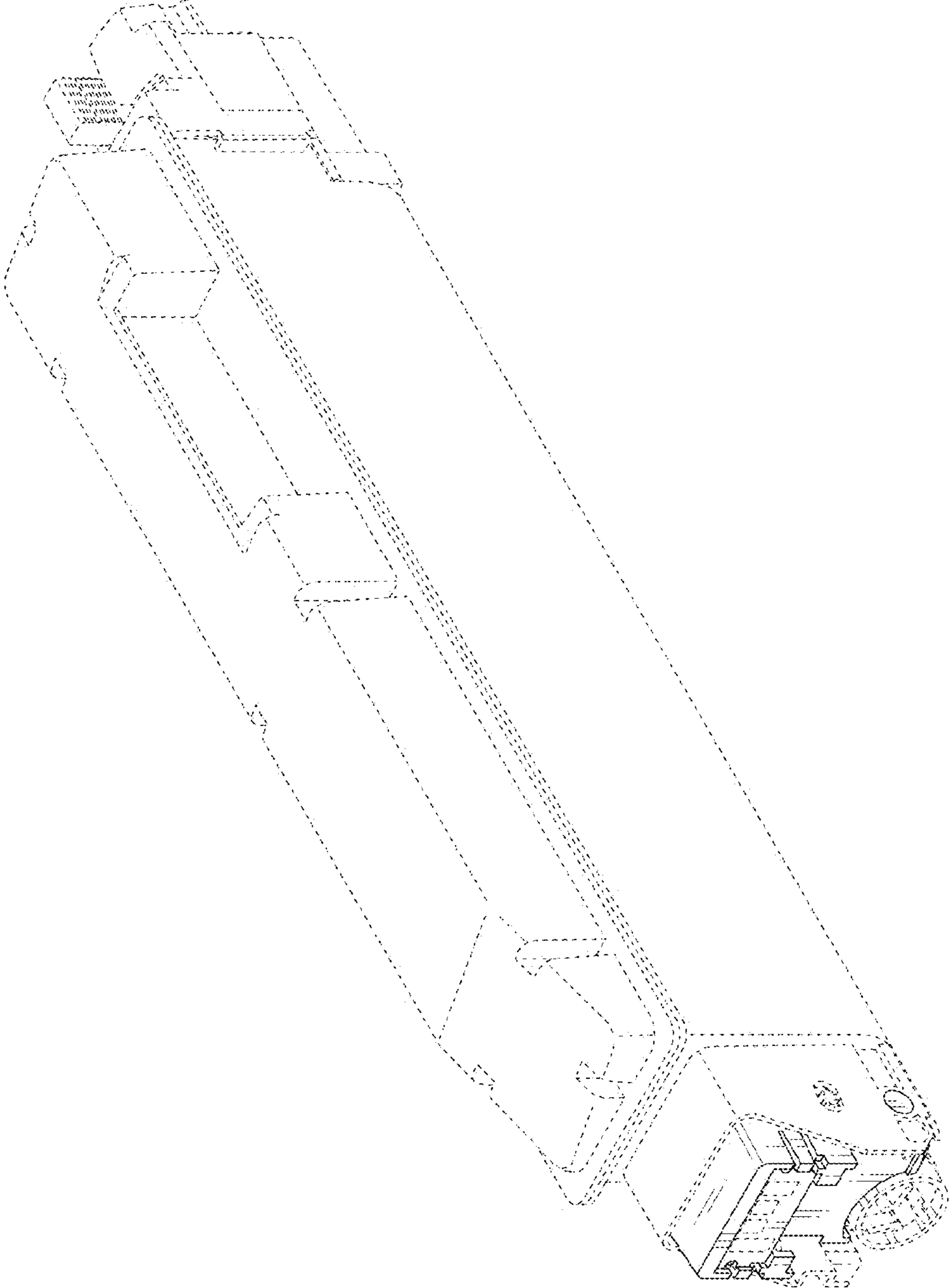

Fig. 2

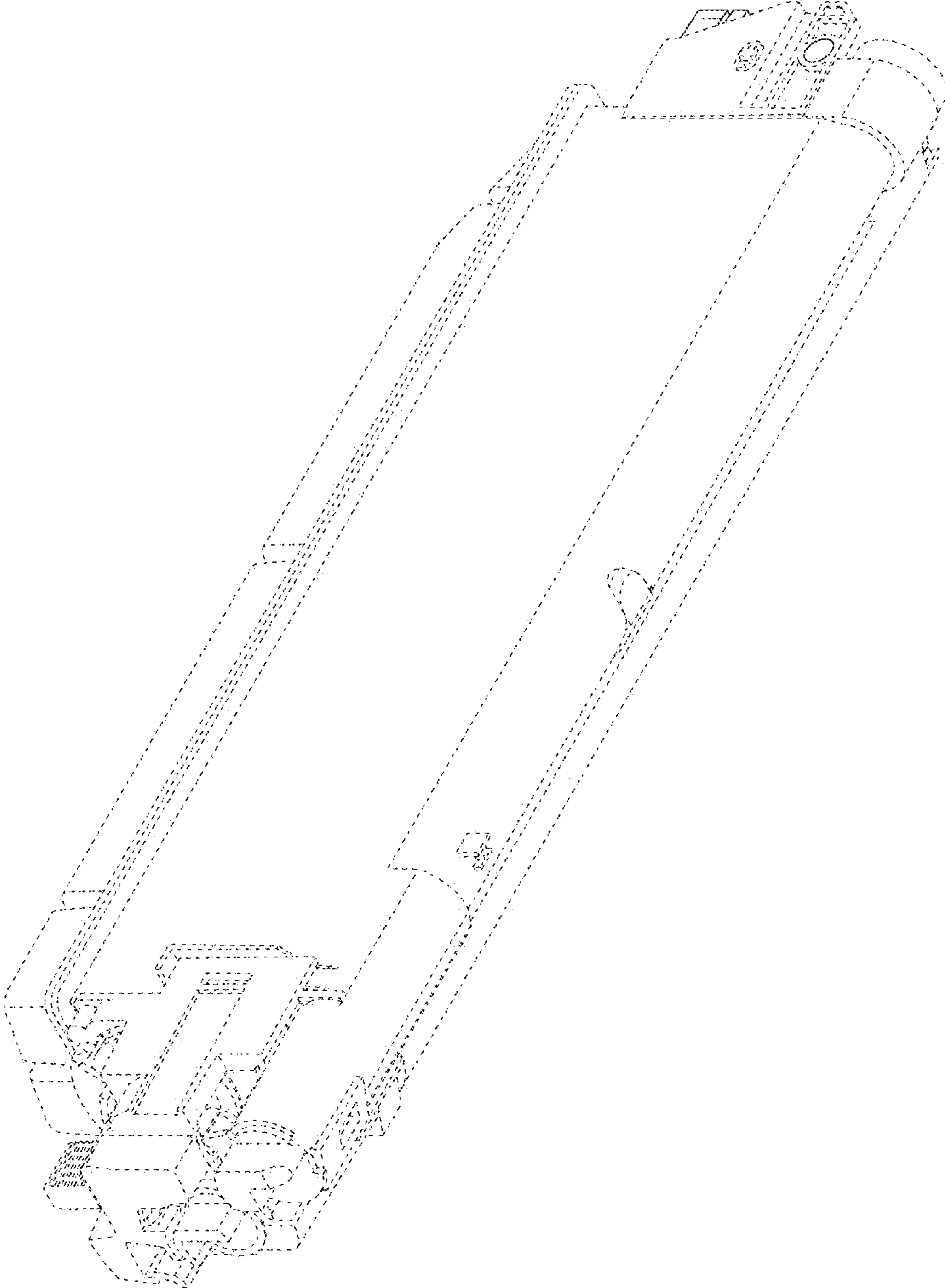

Fig. 3

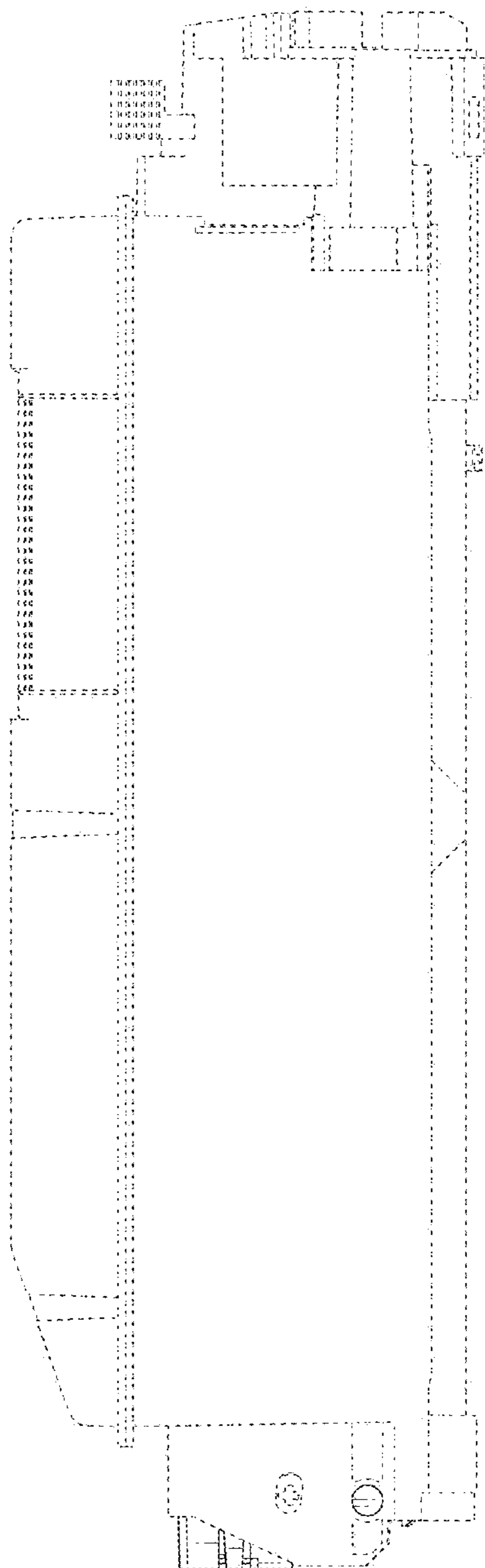

Fig. 4

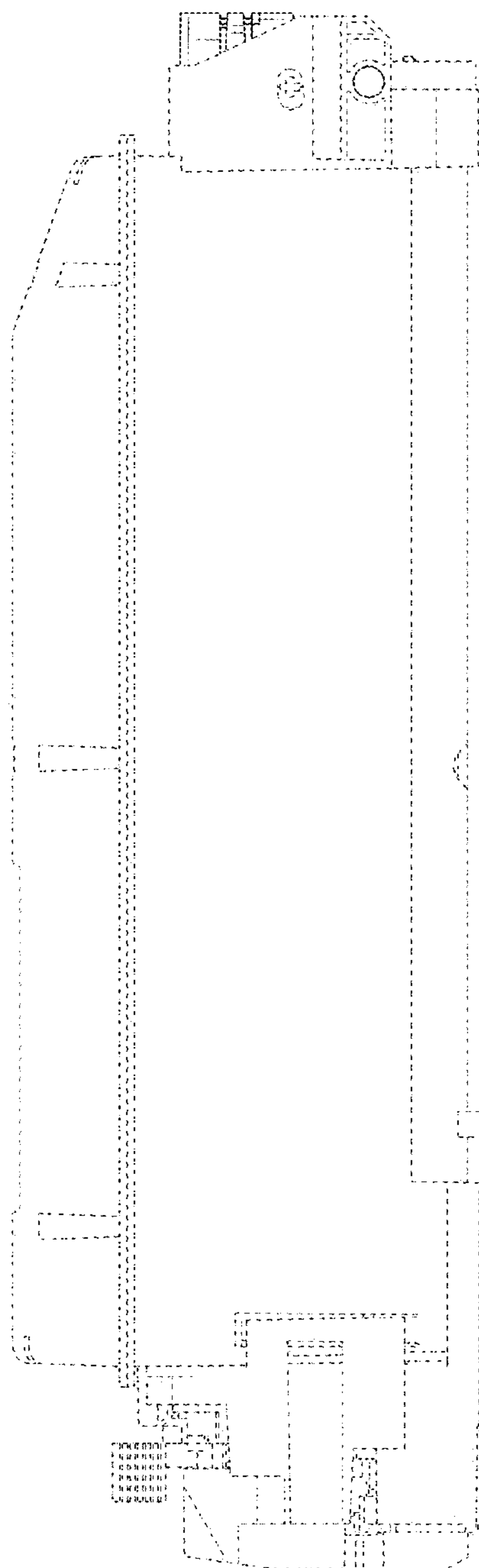

Fig. 6

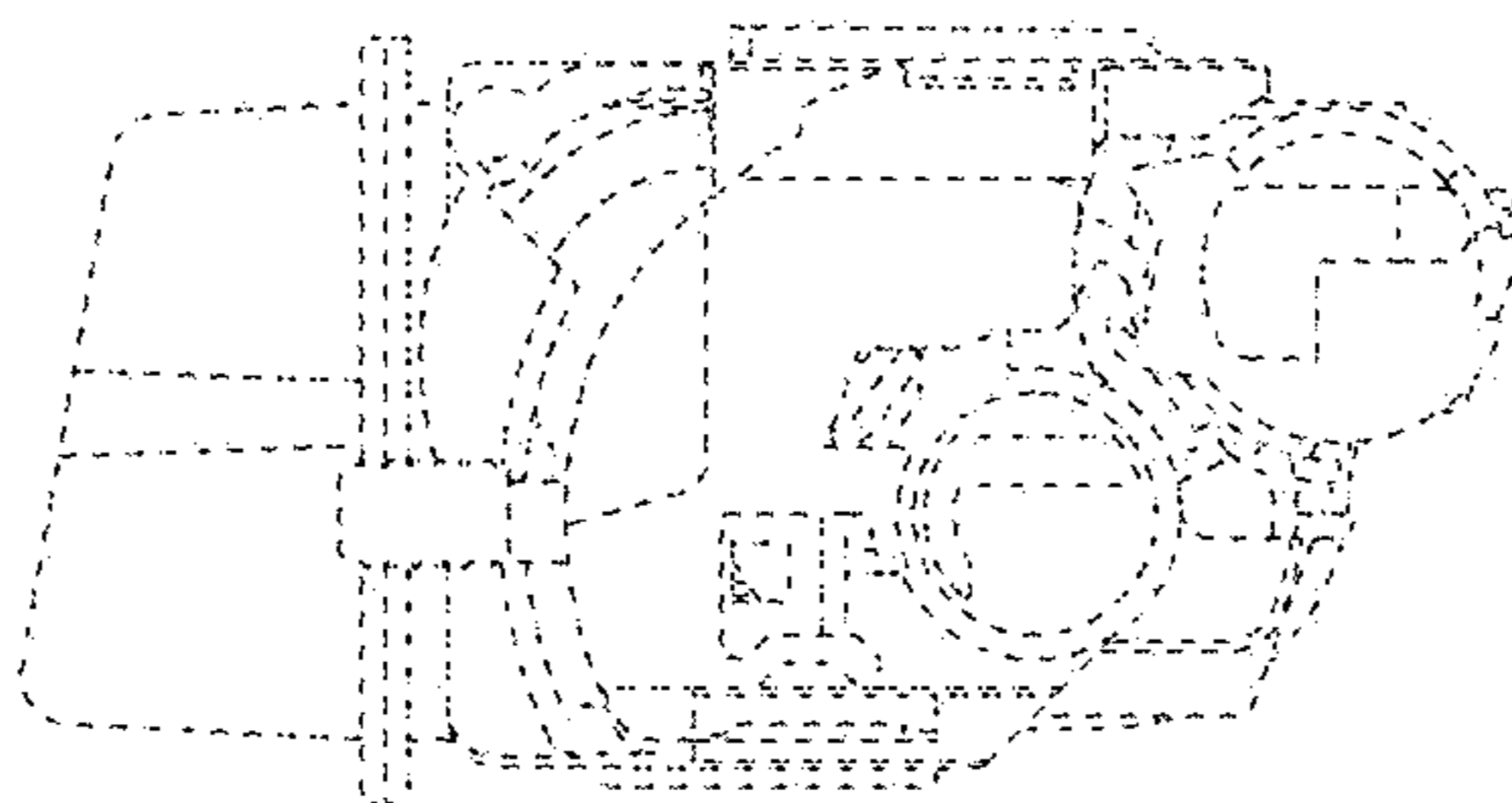

Fig. 5

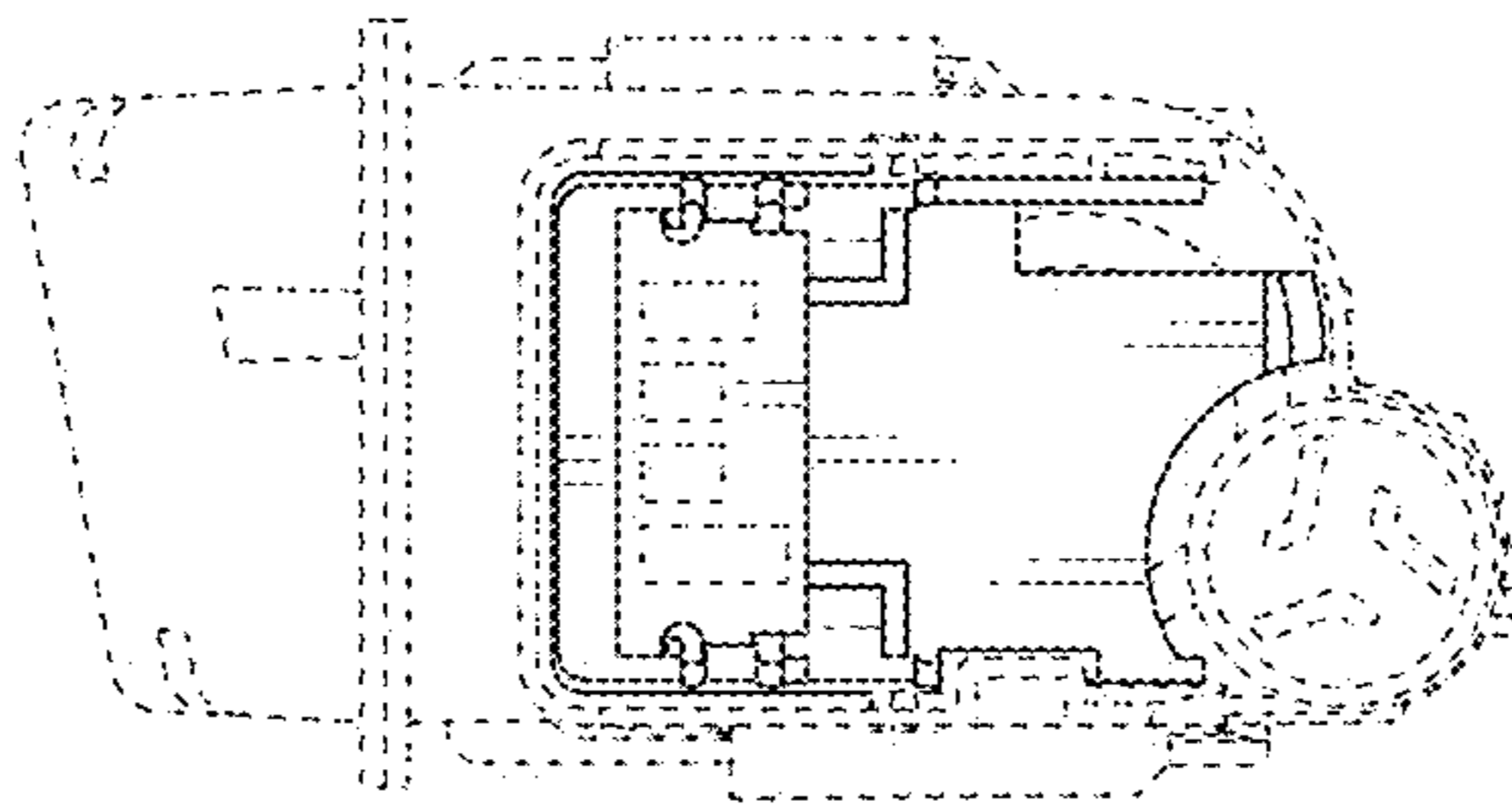

Fig. 7

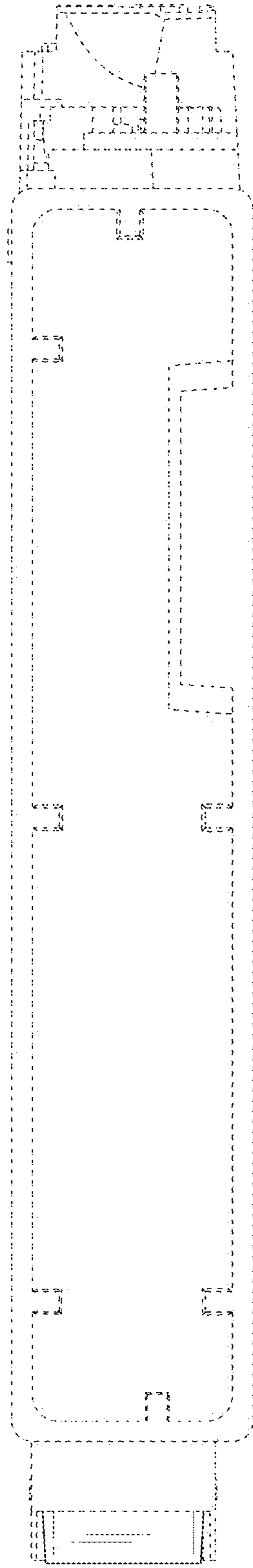

Fig. 8

