



US00D746770S

(12) **United States Design Patent**  
**Nook et al.**

(10) **Patent No.:** **US D746,770 S**  
(45) **Date of Patent:** **\*\* Jan. 5, 2016**

- (54) **BATTERY BOOSTER**
- (71) Applicant: **THE NOCO COMPANY**, Glenwillow, OH (US)
- (72) Inventors: **Jonathan Lewis Nook**, Gates Mills, OH (US); **William Knight Nook, Sr.**, Shaker Heights, OH (US); **James Richard Stanfield**, Peoria, AZ (US); **Derek Michael Underhill**, Tempe, AZ (US)
- (73) Assignee: **THE NOCO COMPANY**, Glenwillow, OH (US)

(\*\*) Term: **14 Years**

(21) Appl. No.: **29/496,699**

(22) Filed: **Jul. 16, 2014**

(51) **LOC (10) Cl.** ..... **13-02**

(52) **U.S. Cl.**  
USPC ..... **D13/107**; D13/103

(58) **Field of Classification Search**  
USPC ..... D13/102–106, 110, 118–119, 184, 103, D13/104, 107–108; D14/96–100, 163, 176  
CPC ..... Y02E 60/12; Y02E 60/122; Y02E 60/124; Y02E 60/50; H01M 2/02; H01M 2/022; H01M 2/0202; H01M 2/0207; H01M 2/0212; H01M 2/1061; H01M 1/1022; H01M 1/1055; H01M 1/1066; H01M 1/105; H01M 1/204; H01M 10/4257; H01M 10/0436; H01M 10/48; H01M 10/44; H01M 10/46; H01M 10/465; H01M 10/482; H01M 2200/30; H01M 2250/30; H01M 2250/40; H02J 7/00; H02J 7/0003; H02J 7/0011; H02J 7/0013; H02J 7/0054; H02J 7/0055; H02J 7/0057; H02J 2007/0062

See application file for complete search history.

(56) **References Cited**

**U.S. PATENT DOCUMENTS**

5,019,767 A \* 5/1991 Shirai et al. .... 320/112  
D485,810 S \* 1/2004 Fiocchi ..... D13/184

D634,313	S	*	3/2011	Fitzpatrick et al.	.....	D14/250
D654,854	S	*	2/2012	Inskeep	.....	D13/107
D664,501	S	*	7/2012	Inskeep	.....	D13/107
D681,550	S	*	5/2013	Corbin	.....	D13/103
D687,768	S	*	8/2013	Minamikawa	.....	D13/107
D694,176	S	*	11/2013	Buetow et al.	.....	D13/103
D694,180	S	*	11/2013	Inskeep	.....	D13/107
D701,490	S	*	3/2014	Inskeep	.....	D13/110
2006/0201558	A1	*	9/2006	Marty et al.	.....	137/613
2008/0213653	A1	*	9/2008	Marukawa et al.	.....	429/72
2011/0116861	A1	*	5/2011	Zhang et al.	.....	403/322.1
2013/0164600	A1	*	6/2013	Roskamp et al.	.....	429/159
2014/0184898	A1	*	7/2014	Overliese et al.	.....	348/372
2015/0099151	A1	*	4/2015	Lavender	.....	429/121

**OTHER PUBLICATIONS**

U.S. Trademark Application No. 86030590 filed on Aug. 6, 2013, including drawing and sample.

\* cited by examiner

*Primary Examiner* — Rosemary K Tarcza

*Assistant Examiner* — Sanjeev Paul

(74) *Attorney, Agent, or Firm* — Vorys, Sater, Seymour and Pease LLP; William L. Klima

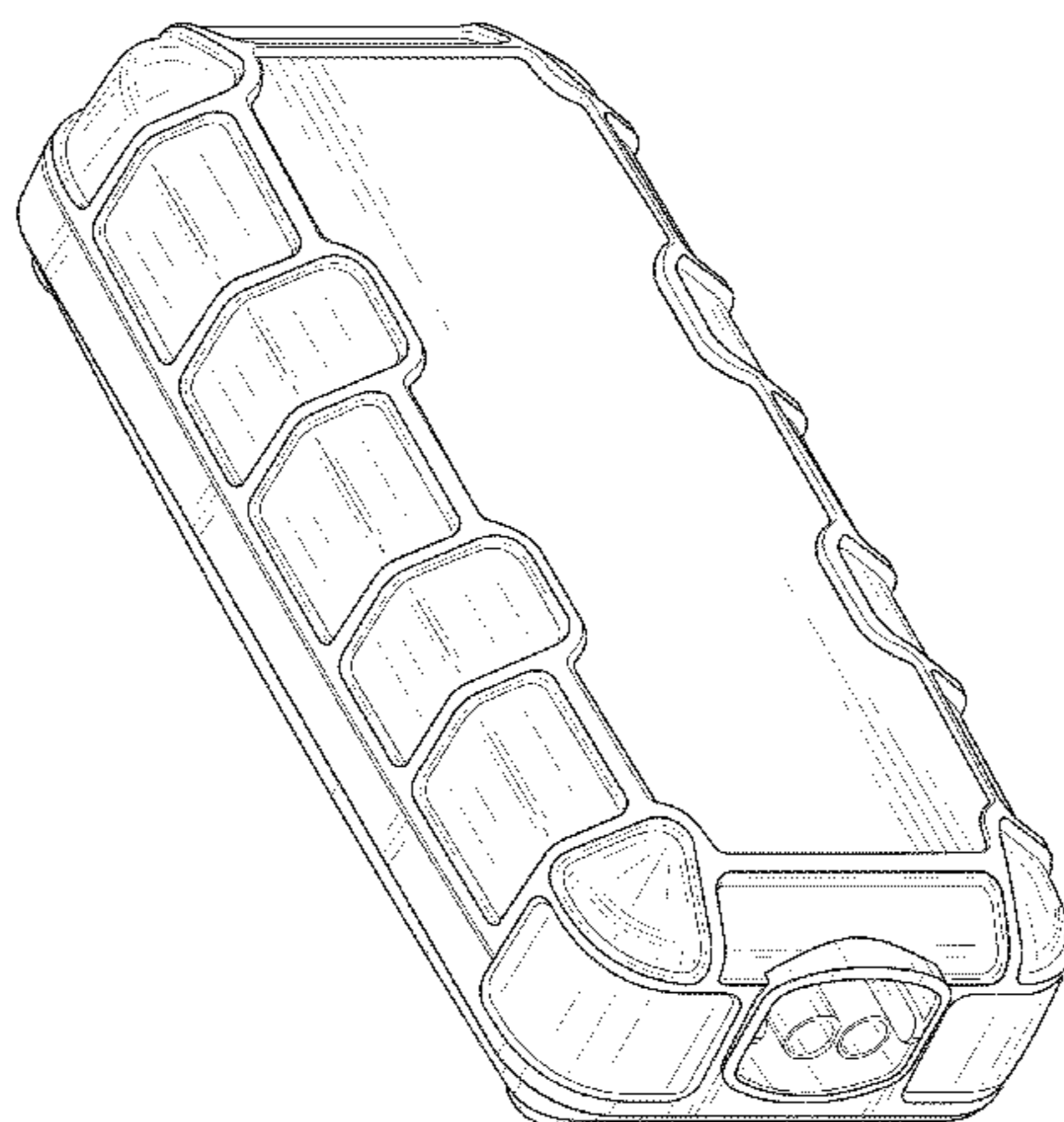
(57) **CLAIM**

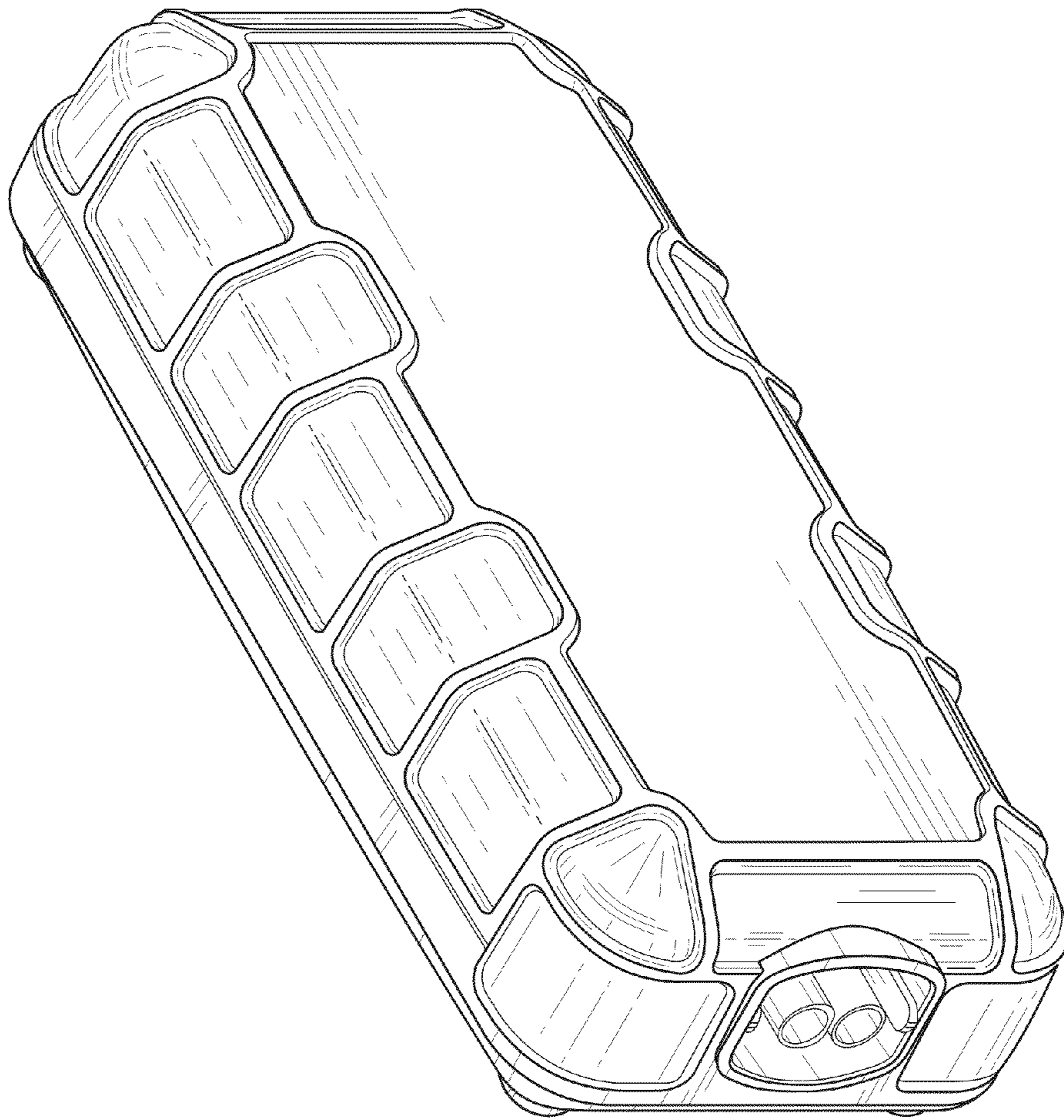
The ornamental design for a battery booster, as shown and described.

**DESCRIPTION**

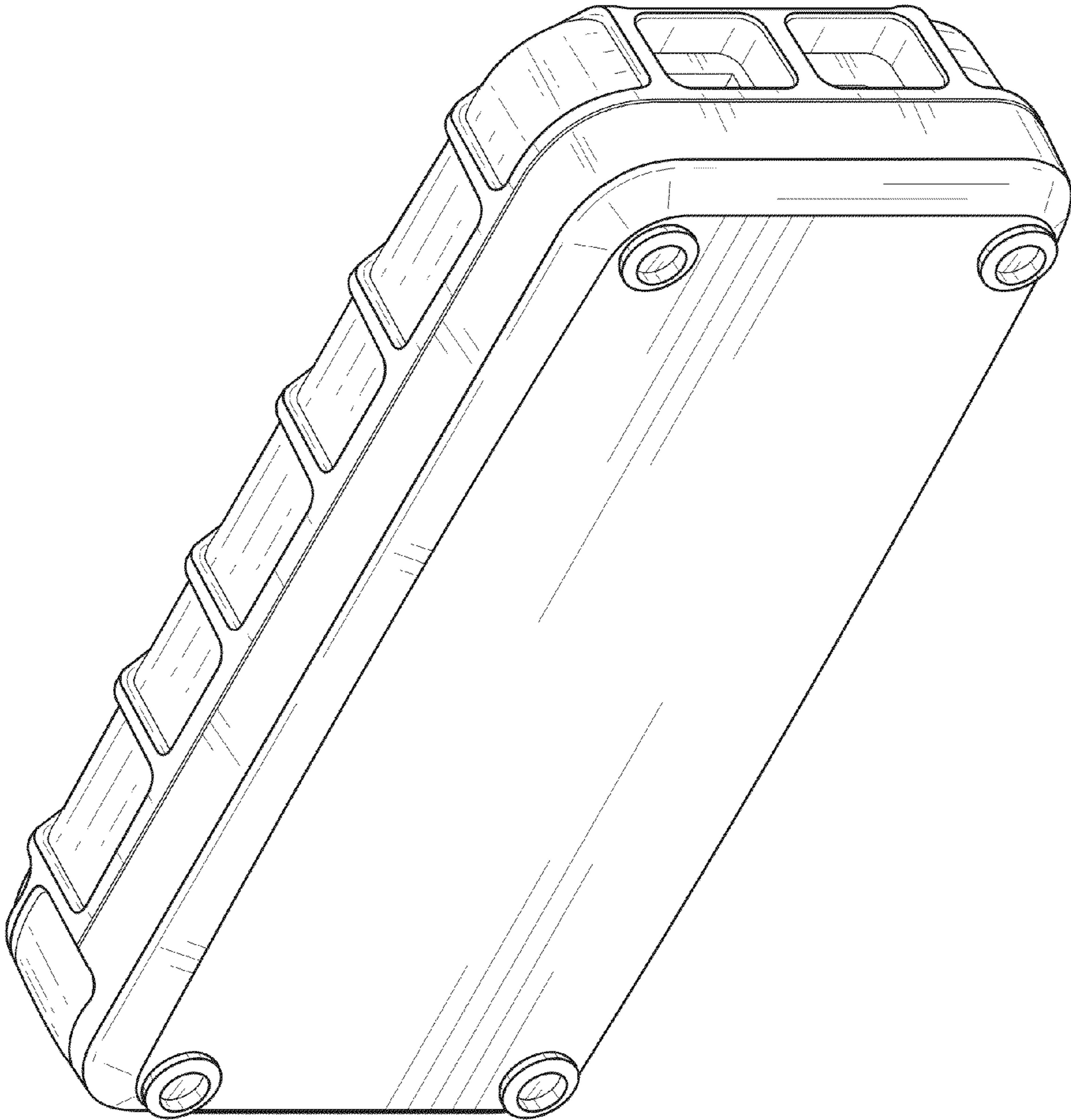
FIG. 1 is a top perspective view for a battery booster;  
FIG. 2 is a bottom perspective view thereof;  
FIG. 3 is a bottom planar view thereof; and  
FIG. 4 is a top planar view thereof.  
FIG. 5 is a left-side elevational view thereof;  
FIG. 6 is a right-side elevational view thereof;  
FIG. 7 is a front-side elevational view thereof; and,  
FIG. 8 is a rear-side elevational view thereof.

**1 Claim, 6 Drawing Sheets**



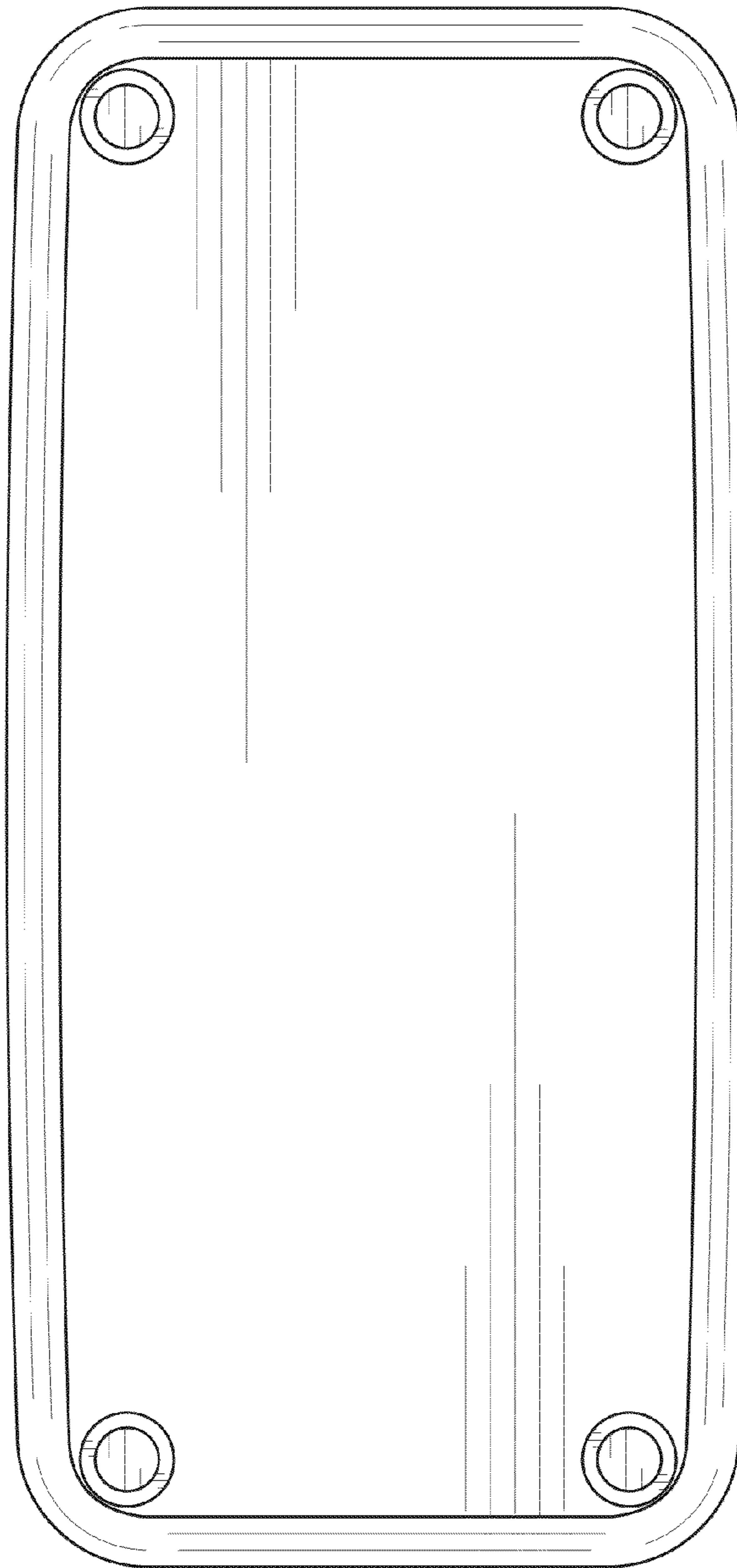


**FIG. 1**

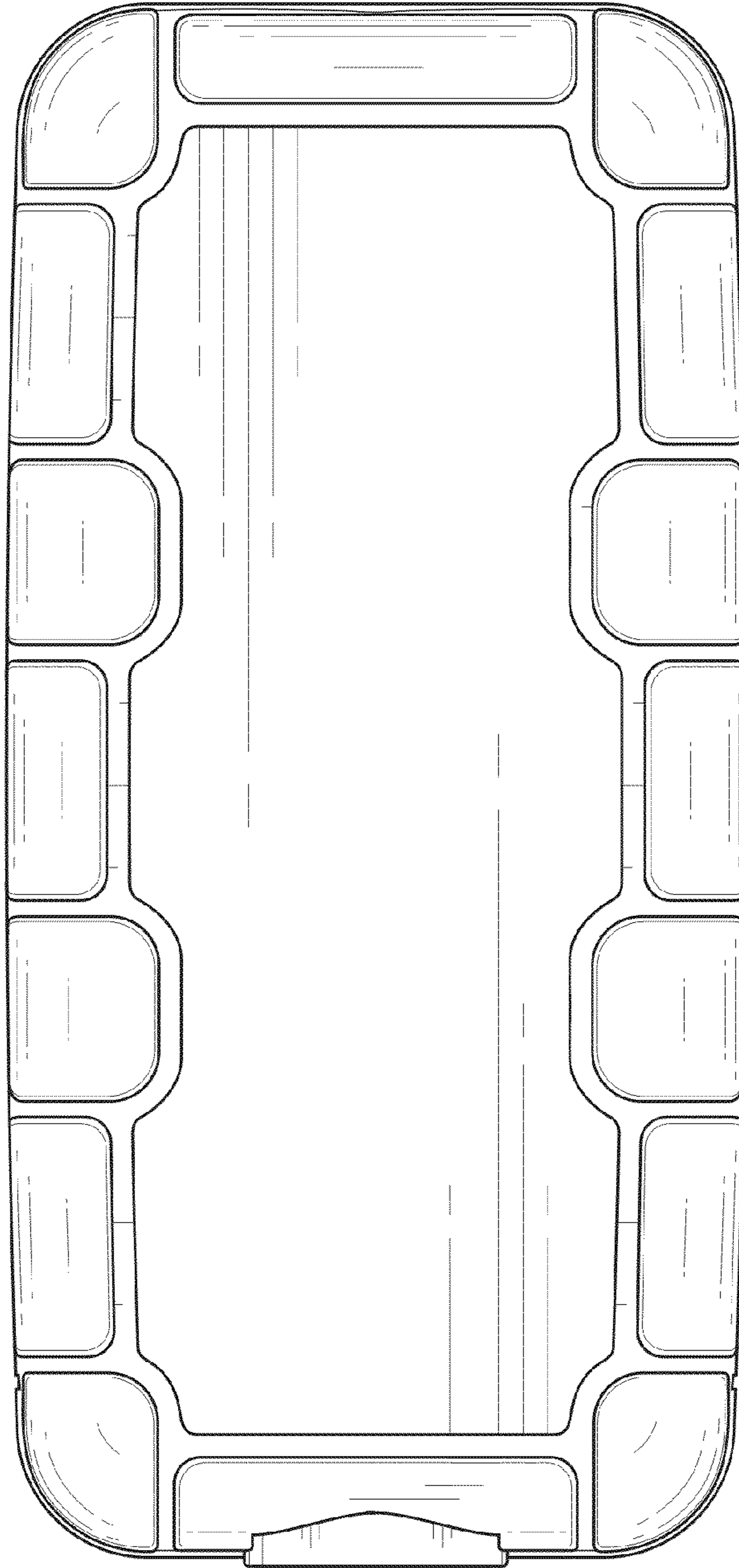


**FIG. 2**

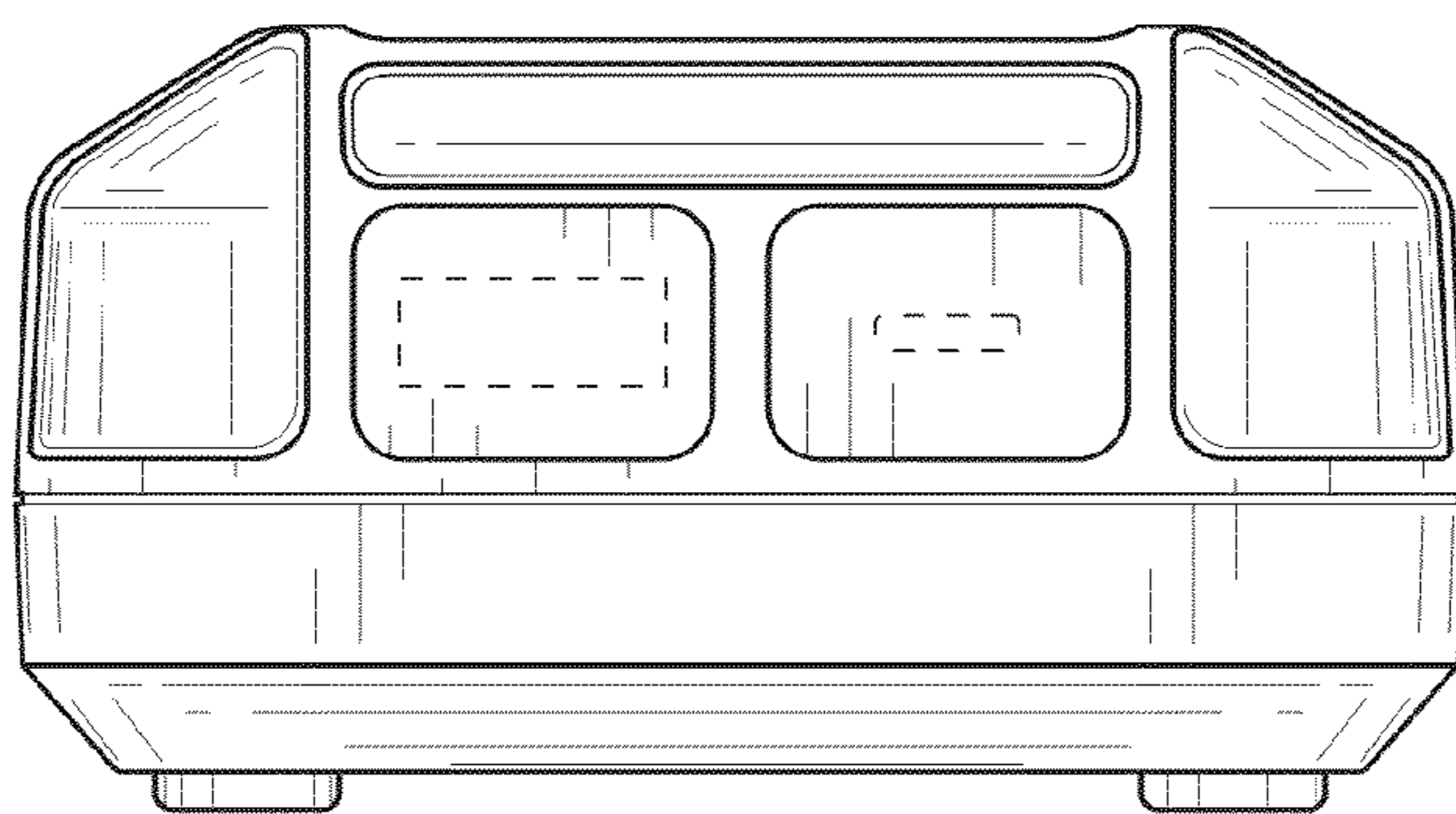




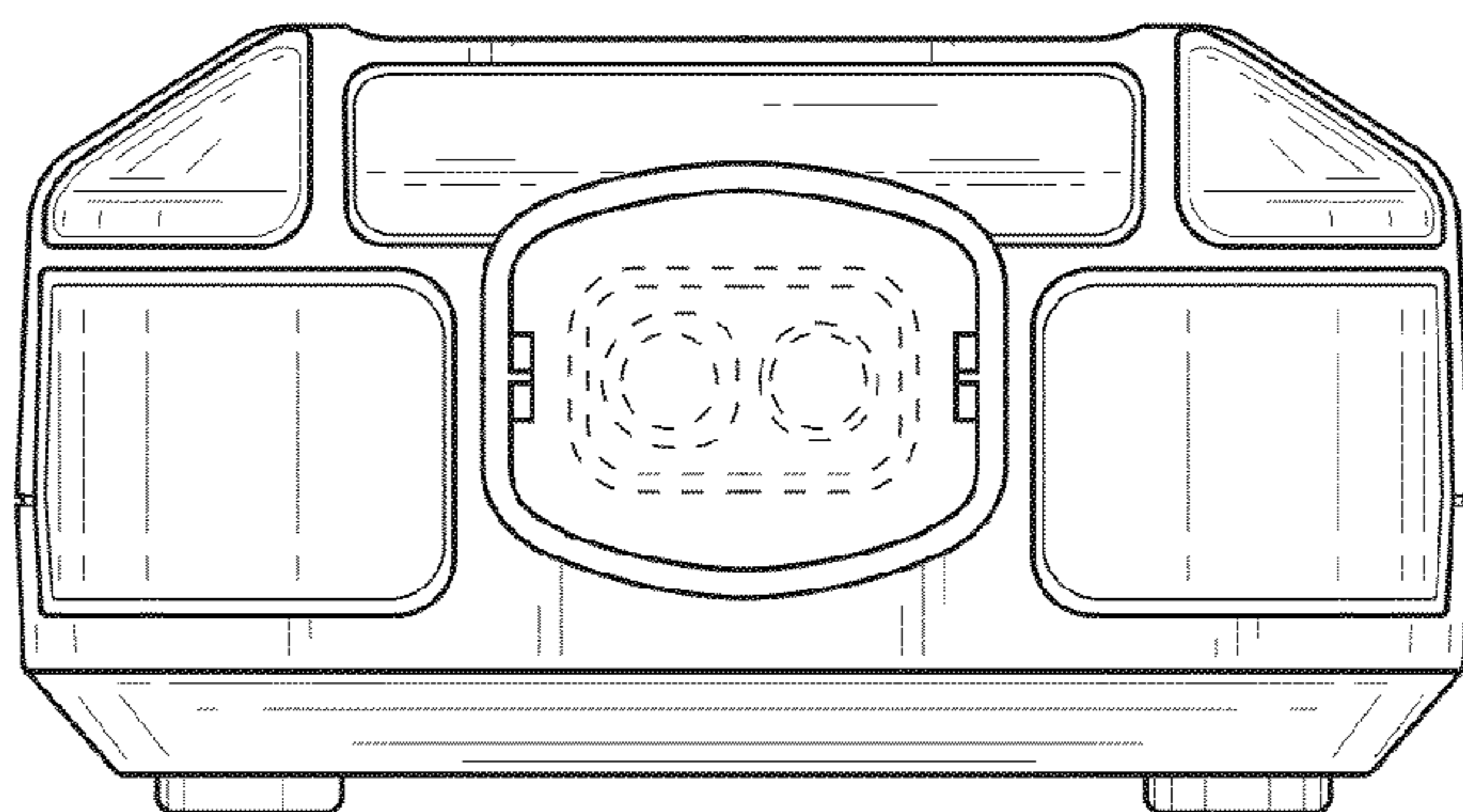
**FIG. 3**



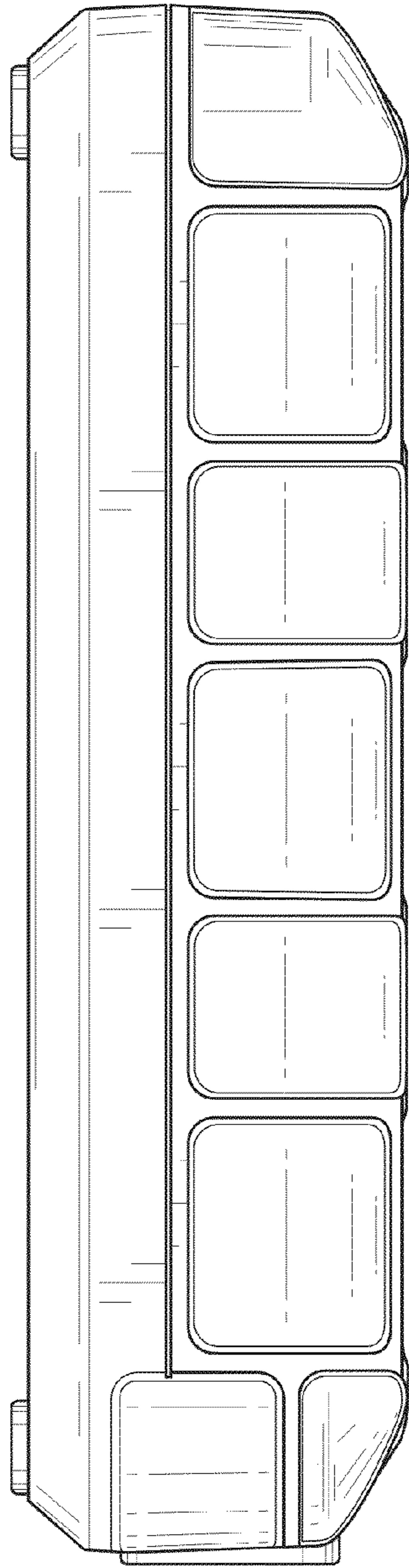
**FIG. 4**



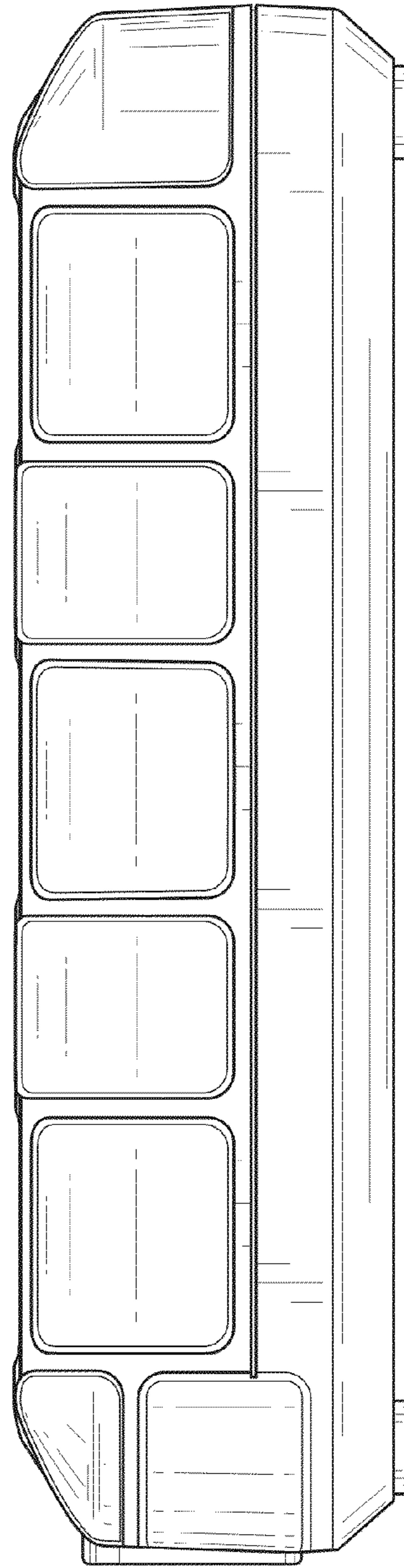
**FIG. 5**



**FIG. 6**



**FIG. 7**



**FIG. 8**