



US00D746720S

(12) **United States Design Patent**
Elia

(10) **Patent No.:** **US D746,720 S**
(45) **Date of Patent:** **** Jan. 5, 2016**

(54) **ORNAMENT**

(71) Applicant: **621542 Ontario Limited**, Toronto (CA)

(72) Inventor: **Paul Elia**, Toronto (CA)

(73) Assignee: **621542 Ontario Limites**, Toronto (CA)

(**) Term: **14 Years**

(21) Appl. No.: **29/472,286**

(22) Filed: **Nov. 11, 2013**

(51) **LOC (10) Cl.** **11-02**

(52) **U.S. Cl.**

USPC **D11/157**

(58) **Field of Classification Search**

USPC D11/4, 5, 29, 40, 157, 184, 202, 204,
D11/218; D6/450, 451, 458, 462, 497, 499;
D99/99; D20/29, 36; 428/3, 7-16,
428/542.2, 542.4; 248/915; 52/80.1, 80.2,
52/81.6

See application file for complete search history.

(56) **References Cited**

U.S. PATENT DOCUMENTS

D30,611 S *	4/1899	Clark et al.	D11/202
D181,415 S *	11/1957	Hentges et al.	D11/29
D244,970 S *	7/1977	Weiner	D11/202
D252,802 S *	9/1979	Lavin	D11/29
D310,795 S *	9/1990	Boivin	D11/202
D316,530 S *	4/1991	Clifton	D11/202
D357,646 S *	4/1995	Movizzo	D11/202
5,988,401 A *	11/1999	Gardner et al.	211/14
D569,766 S *	5/2008	Cavness	D11/157
D571,253 S *	6/2008	Cavness	D11/157
D627,680 S *	11/2010	Dufresne	D11/157
D641,613 S *	7/2011	Isberner	D8/383
D641,660 S *	7/2011	Cavness	D11/157
D654,828 S *	2/2012	Piric	D11/157
D664,888 S *	8/2012	Villiers et al.	D11/131
D664,889 S *	8/2012	Cavness	D11/157
D667,752 S *	9/2012	Leclerc	D11/202
D673,075 S *	12/2012	Elia	D11/157
D678,101 S *	3/2013	Parvex	D11/1

D715,683 S * 10/2014 Letney D11/157
D716,181 S * 10/2014 McAdams D11/202
D716,182 S * 10/2014 McAdams D11/202

* cited by examiner

Primary Examiner — John Windmuller

Assistant Examiner — Steven Czyz

(74) *Attorney, Agent, or Firm* — McMillan LLP

(57) **CLAIM**

The ornamental design for an ornament, as shown and described.

DESCRIPTION

FIG. 1 is a perspective view of the ornament taken from the right front side.

FIG. 2 is a perspective view of the design of FIG. 1 taken from the left back side.

FIG. 3 is a front view of the design of FIG. 1.

FIG. 4 is a back view of the design of FIG. 1.

FIG. 5 is a left side view of the design of FIG. 1.

FIG. 6 is a right side view the design of FIG. 1.

FIG. 7 is a perspective view of a second embodiment of the ornament taken from the right front side.

FIG. 8 is a perspective view of the design of FIG. 7 taken from the left back side.

FIG. 9 is a front view of the design of FIG. 7.

FIG. 10 is a back view of the design of FIG. 7.

FIG. 11 is a left side view of the design of FIG. 7.

FIG. 12 is a right side view the design of FIG. 7.

FIG. 13 is a perspective view of a third embodiment of the ornament taken from the right front side.

FIG. 14 is a perspective view of the design of FIG. 13 taken from the left back side.

FIG. 15 is a front view of the design of FIG. 13.

FIG. 16 is a back view of the design of FIG. 13.

FIG. 17 is a left side view of the design of FIG. 13.

FIG. 18 is a right side view the design of FIG. 13.

FIG. 19 is a perspective view of a fourth embodiment of the ornament taken from the right front side.

FIG. 20 is a perspective view of the design of FIG. 19 taken from the left back side.

FIG. 21 is a front view of the design of FIG. 19.

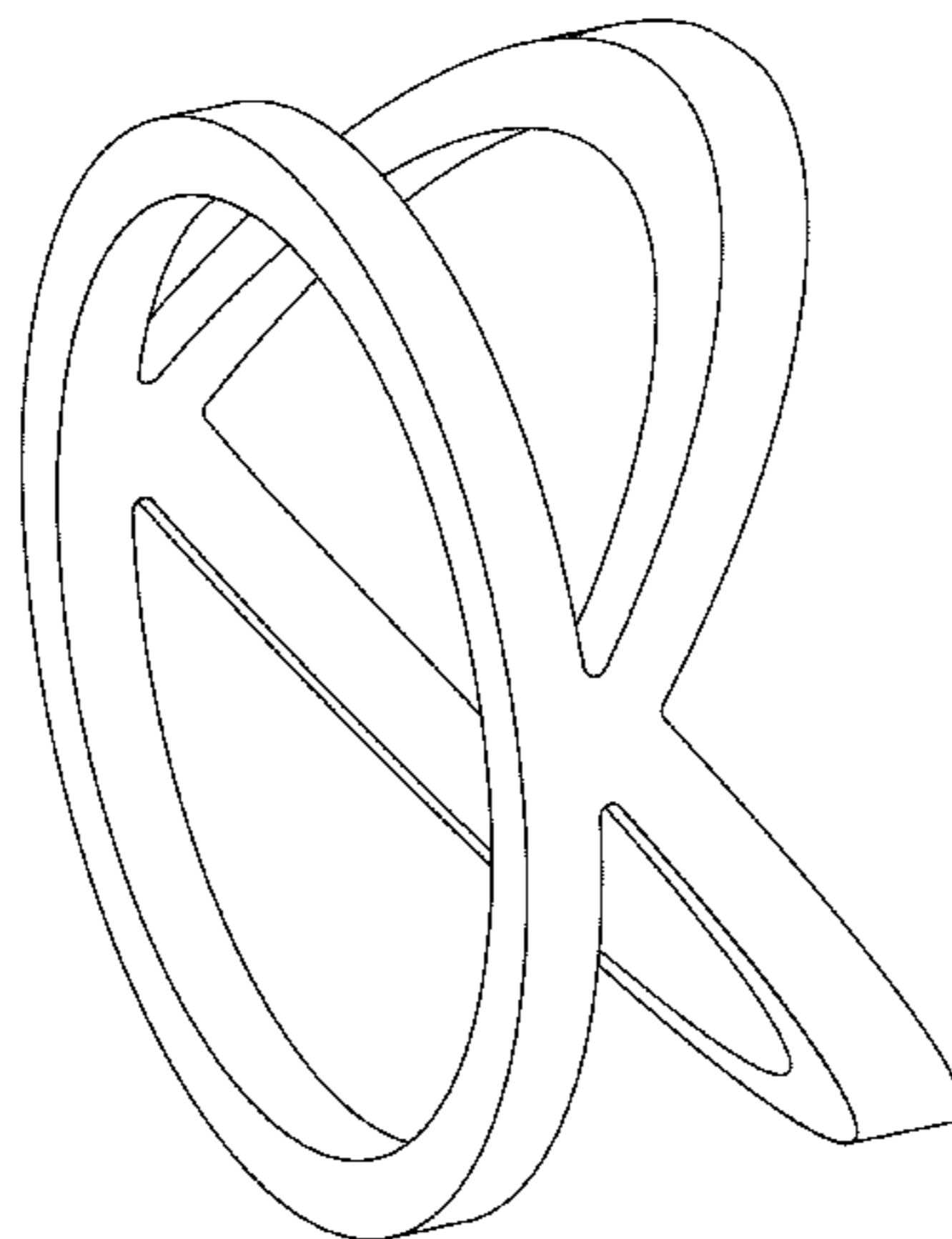

FIG. 22 is a back view of the design of FIG. 19.
FIG. 23 is a left side view of the design of FIG. 19.
FIG. 24 is a right side view the design of FIG. 19.
FIG. 25 is a perspective view of a fifth embodiment of the ornament taken from the right front side.
FIG. 26 is a perspective view of the design of FIG. 25 taken from the left back side.
FIG. 27 is a front view of the design of FIG. 25.
FIG. 28 is a back view of the design of FIG. 25.
FIG. 29 is a left side view of the design of FIG. 25.
FIG. 30 is a right side view the design of FIG. 25.
FIG. 31 is a perspective view of a sixth embodiment of the ornament taken from the right front side.
FIG. 32 is a perspective view of the design of FIG. 31 taken from the left back side.

FIG. 33 is a front view of the design of FIG. 31.
FIG. 34 is a back view of the design of FIG. 31.
FIG. 35 is a left side view of the design of FIG. 31.
FIG. 36 is a right side view the design of FIG. 31.
FIG. 37 is a perspective view of a seventh embodiment of the ornament taken from the right front side.
FIG. 38 is a perspective view of the design of FIG. 37 taken from the left back side.
FIG. 39 is a front view of the design of FIG. 37.
FIG. 40 is a back view of the design of FIG. 37.
FIG. 41 is a left side view of the design of FIG. 37; and,
FIG. 42 is a right side view the design of FIG. 37.

1 Claim, 42 Drawing Sheets

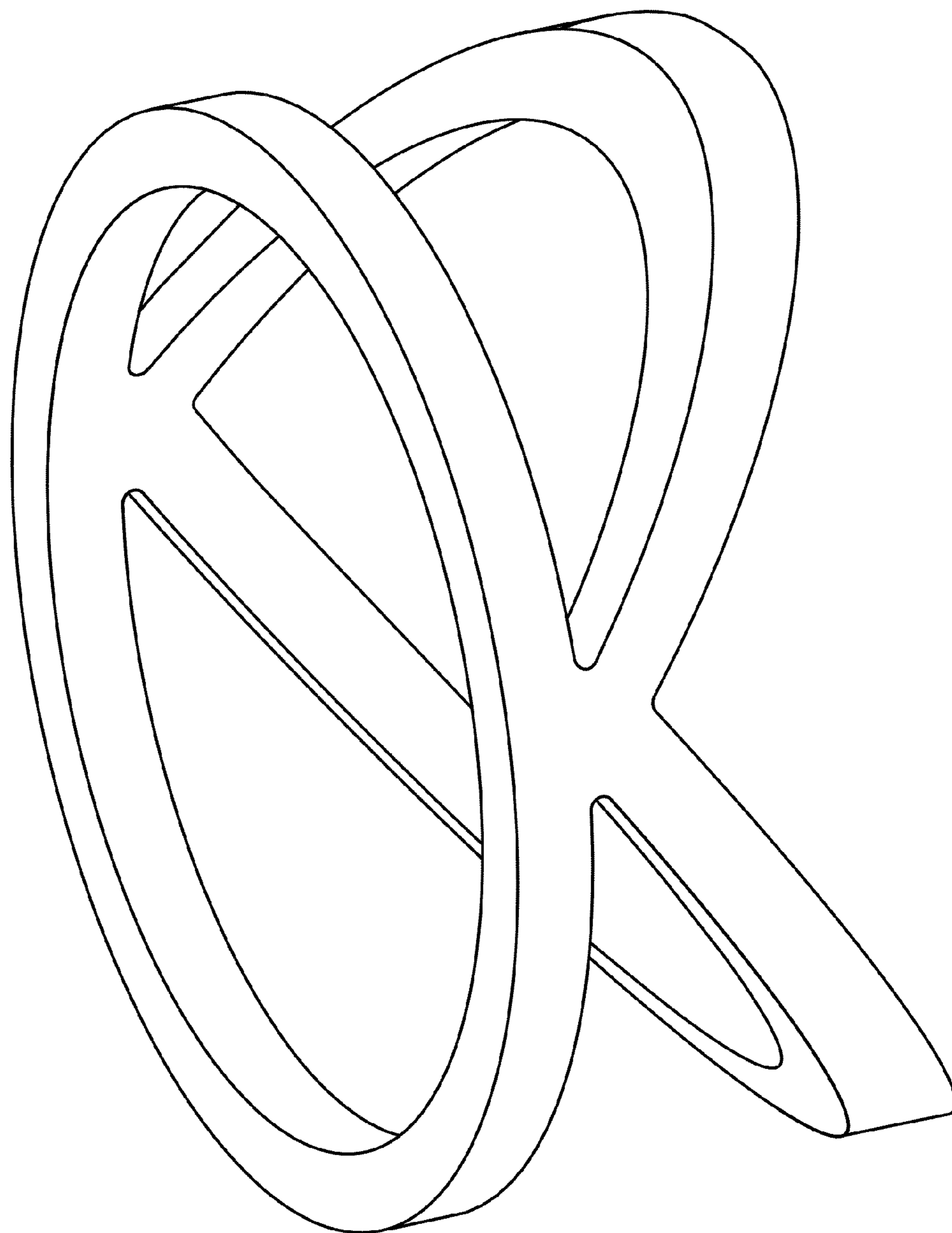

FIG. 1

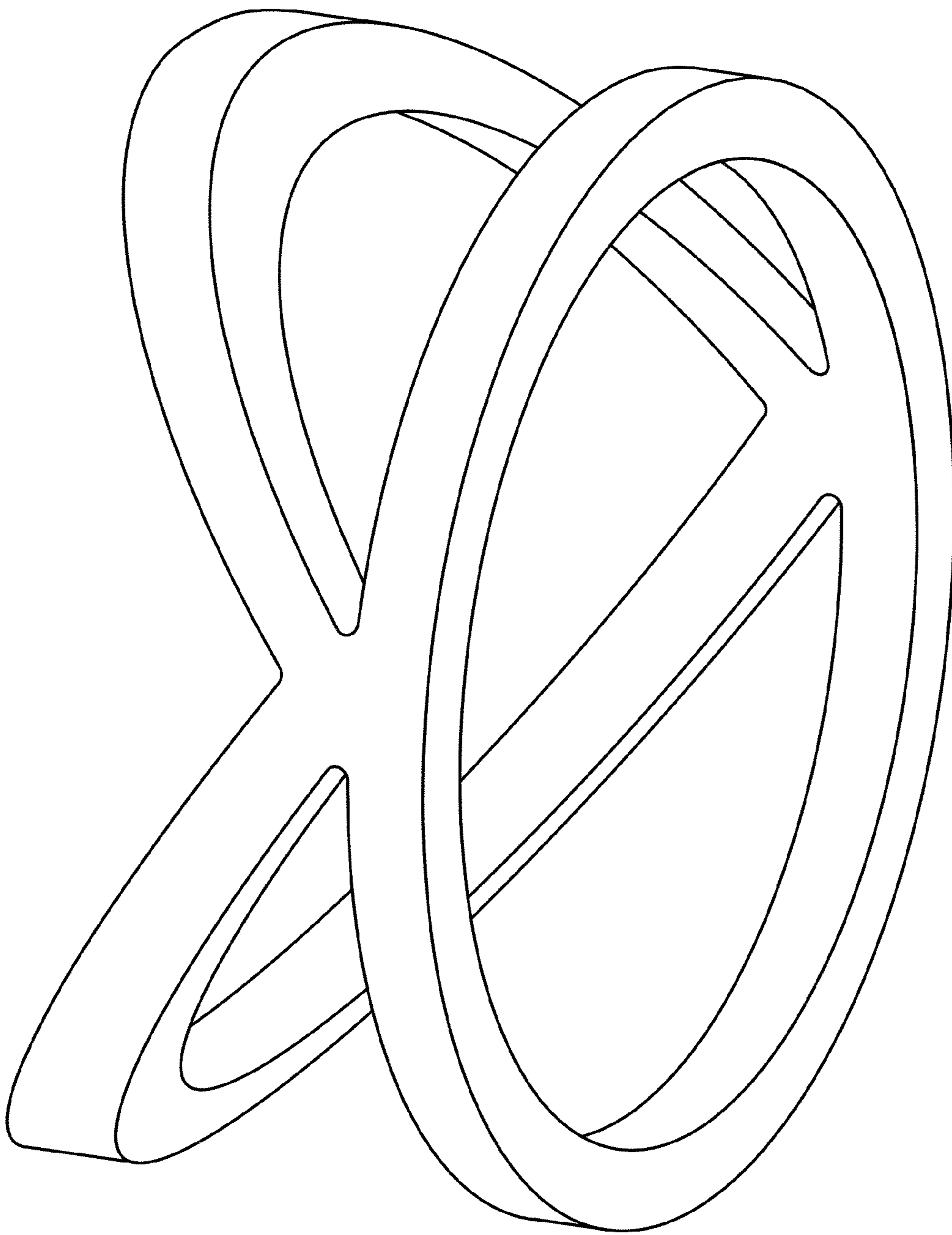

FIG. 2

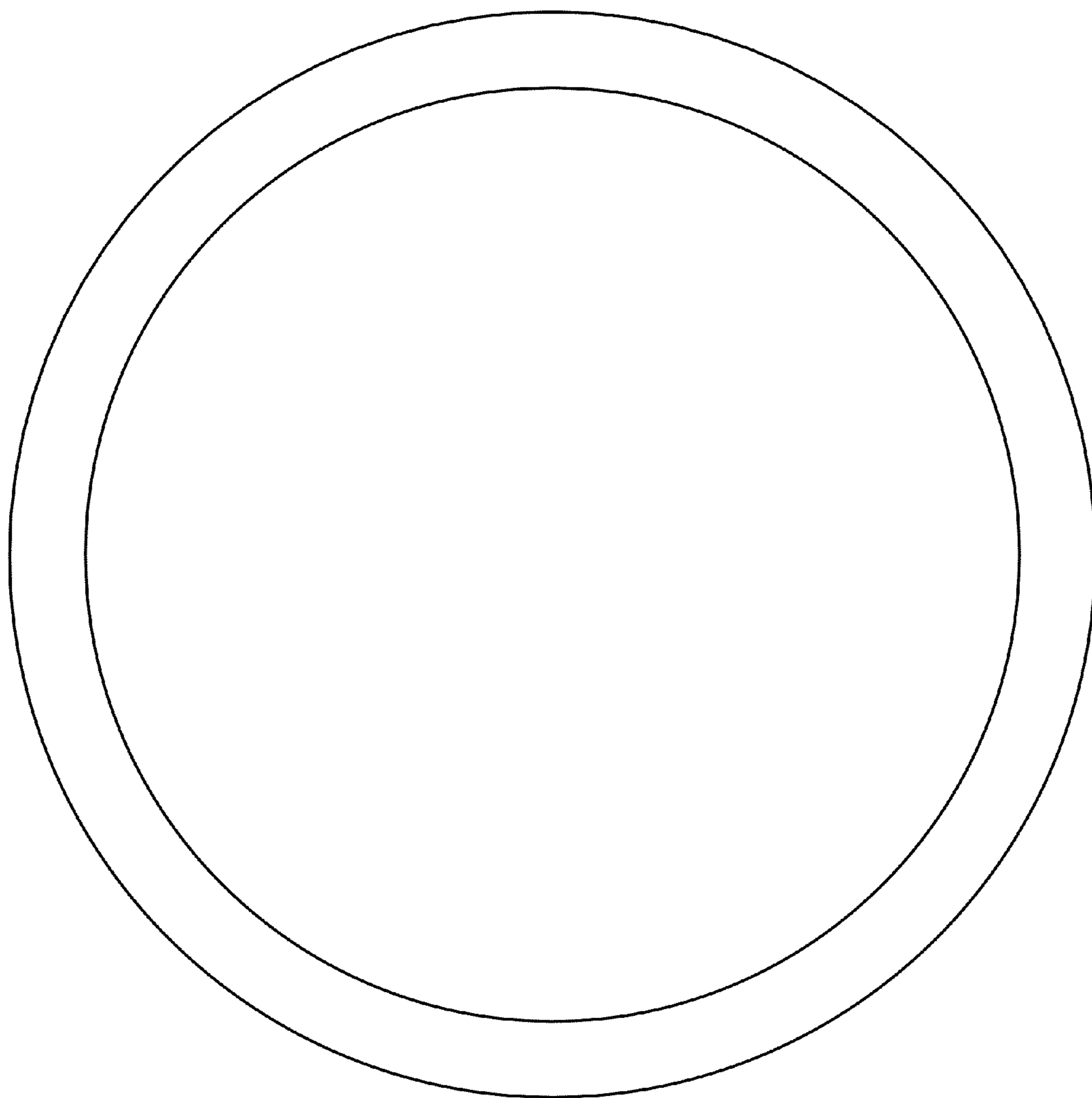

FIG. 3

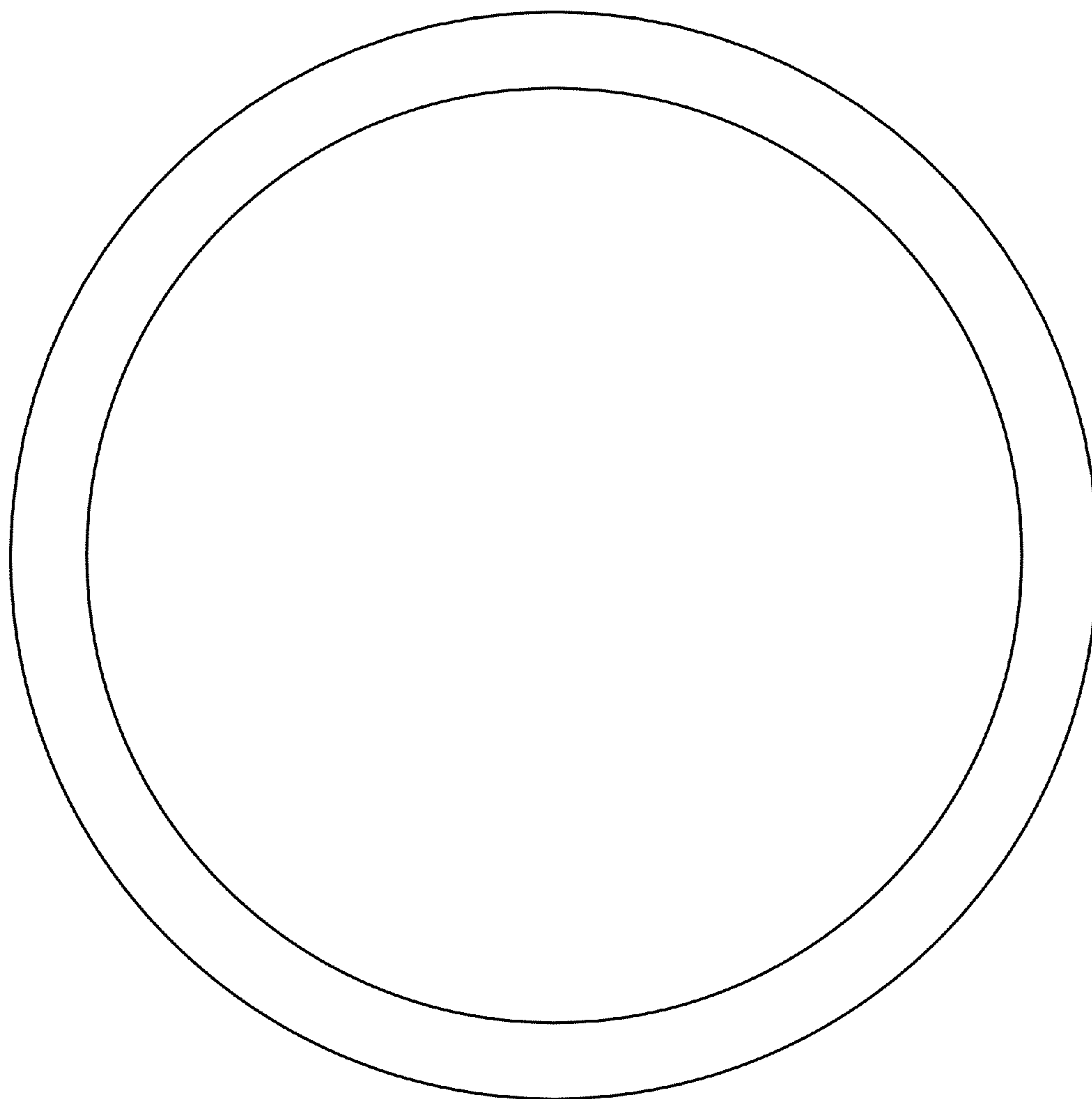

FIG. 4

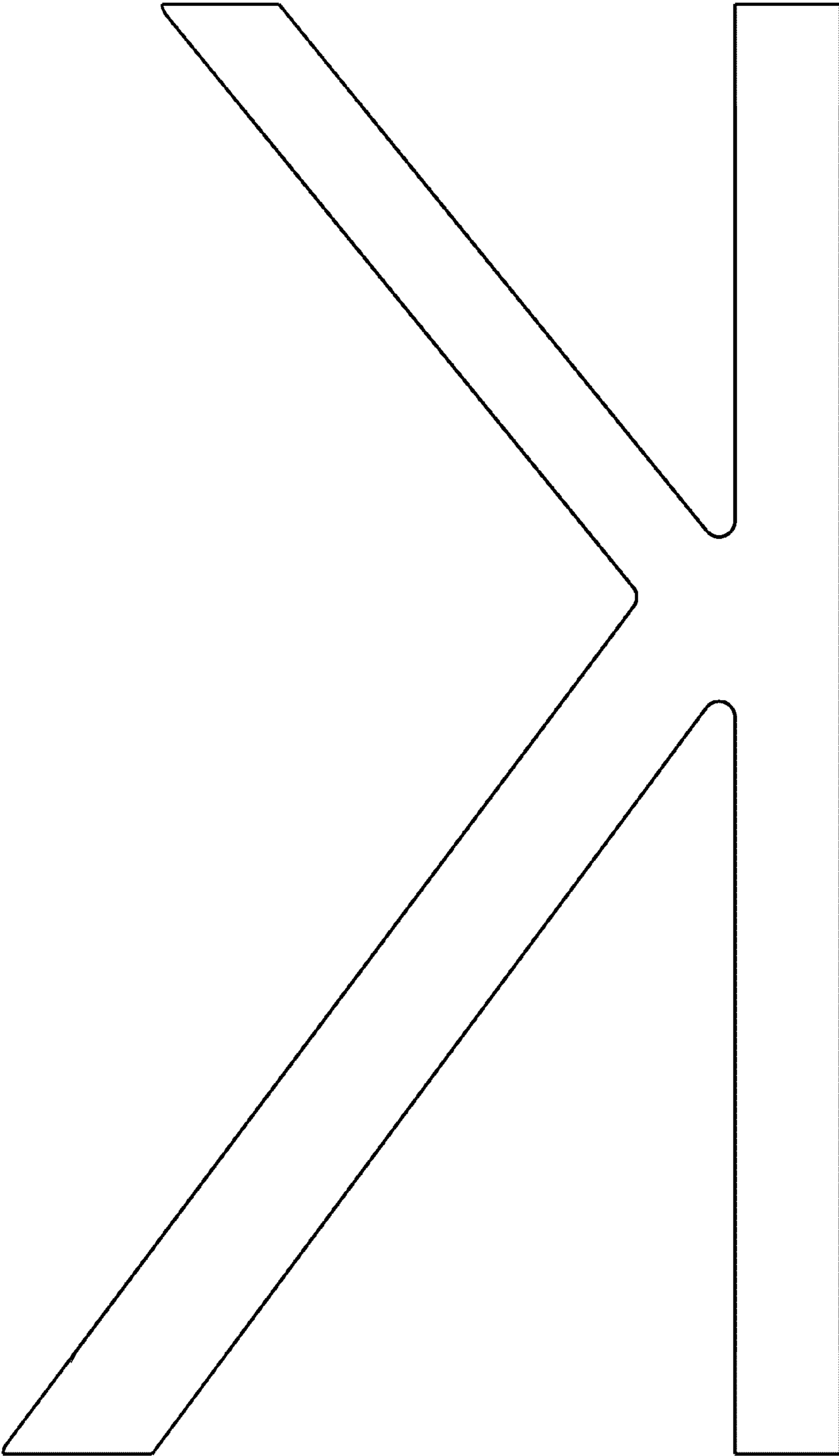

FIG. 5

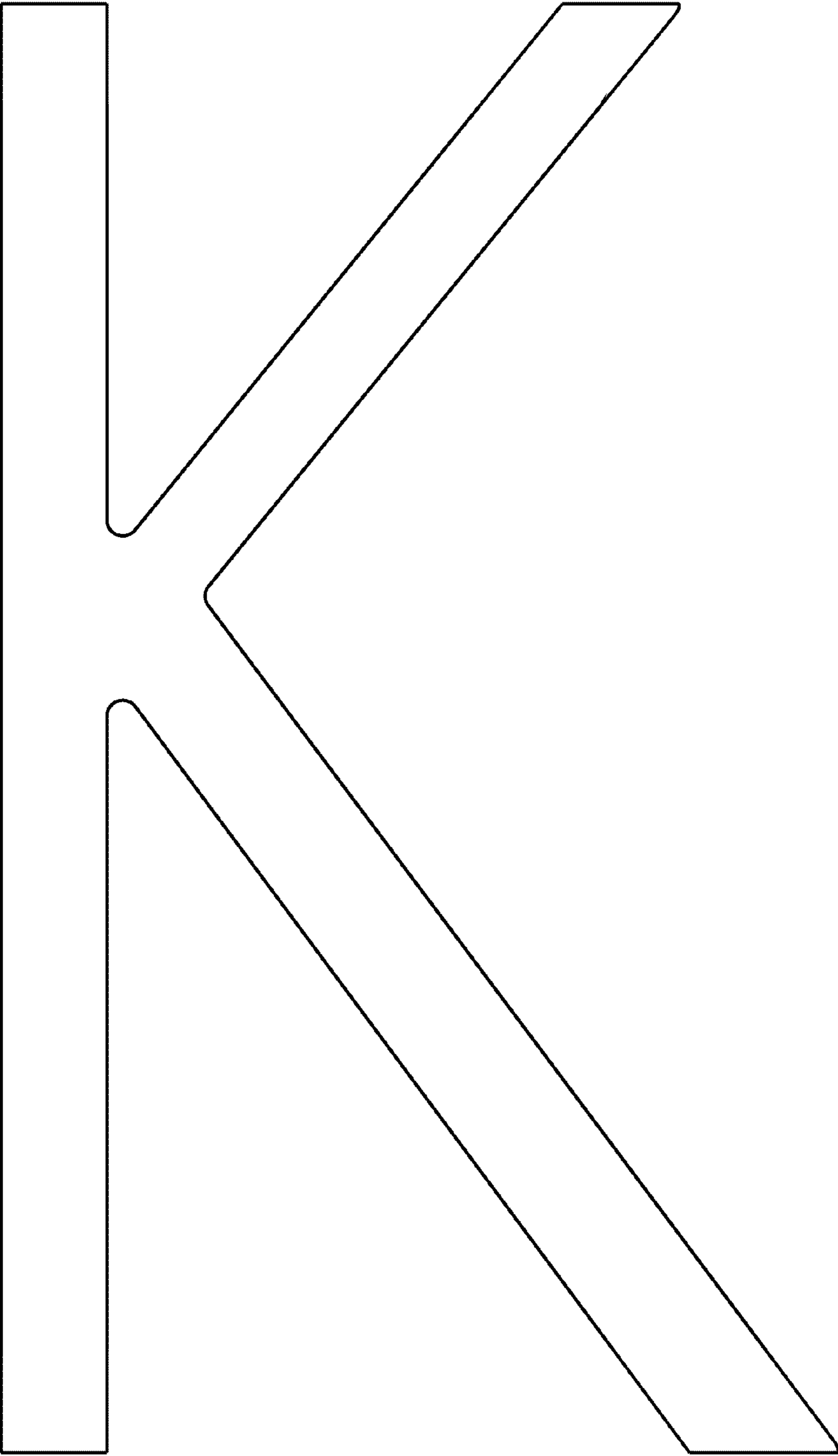

FIG. 6

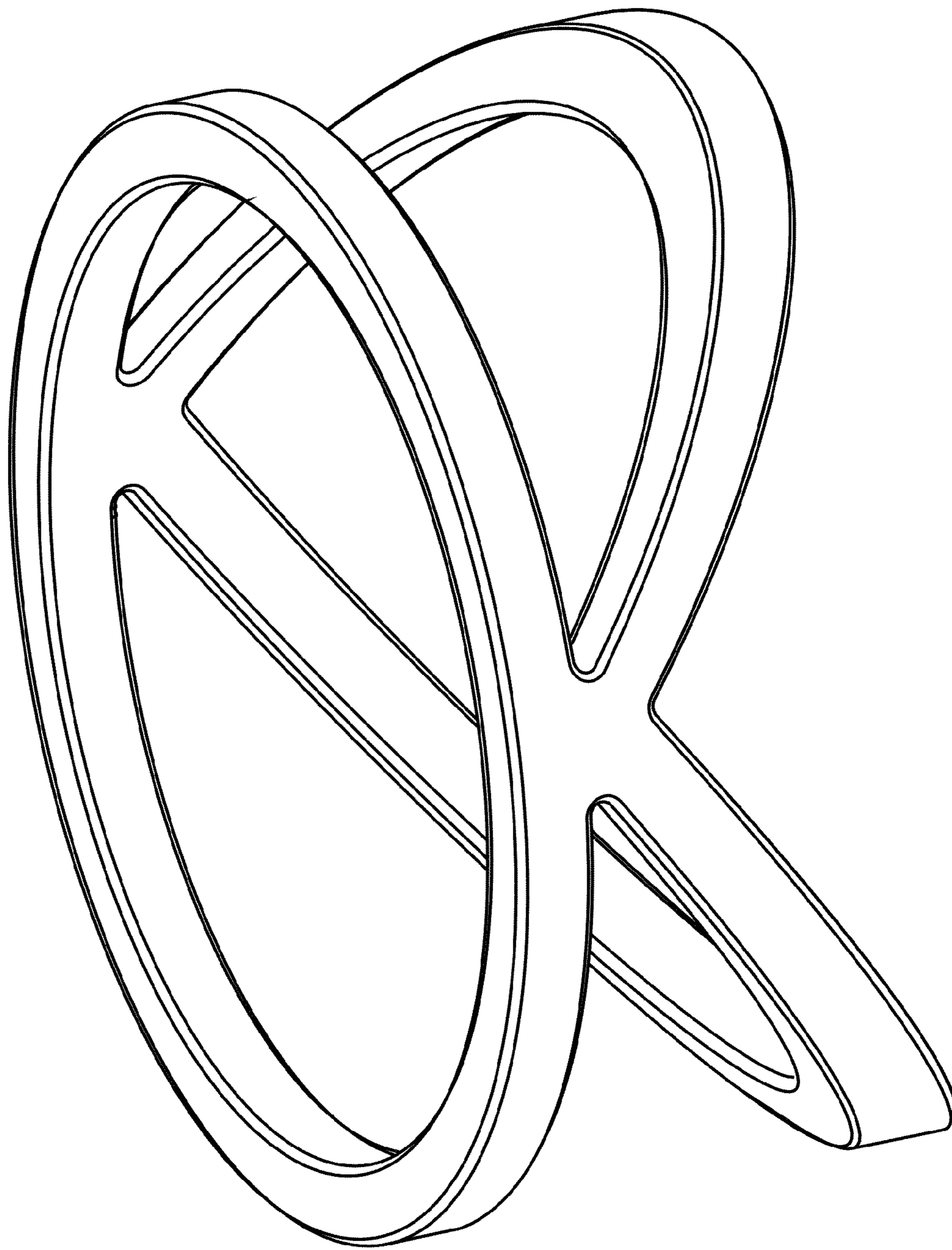

FIG. 7

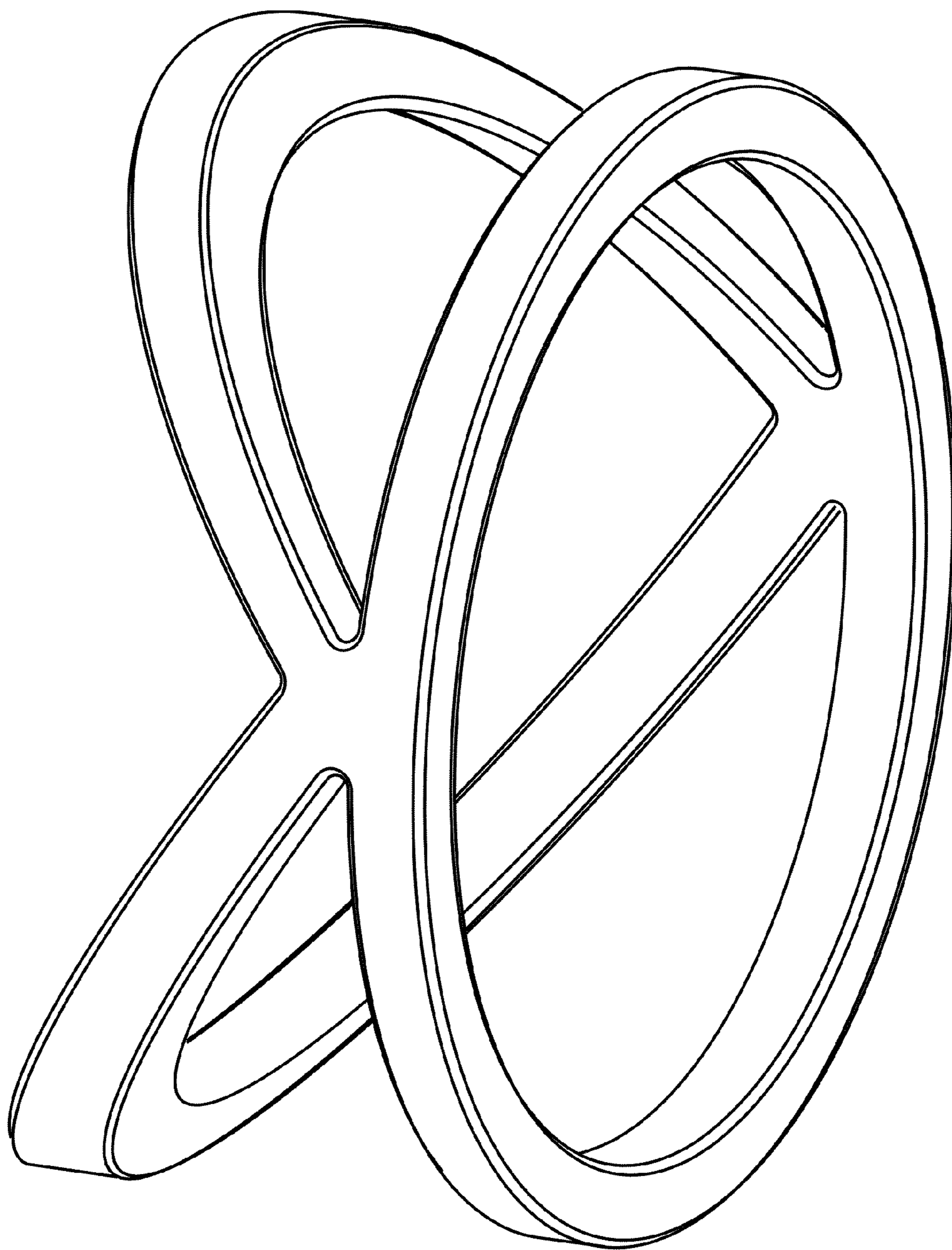

FIG. 8

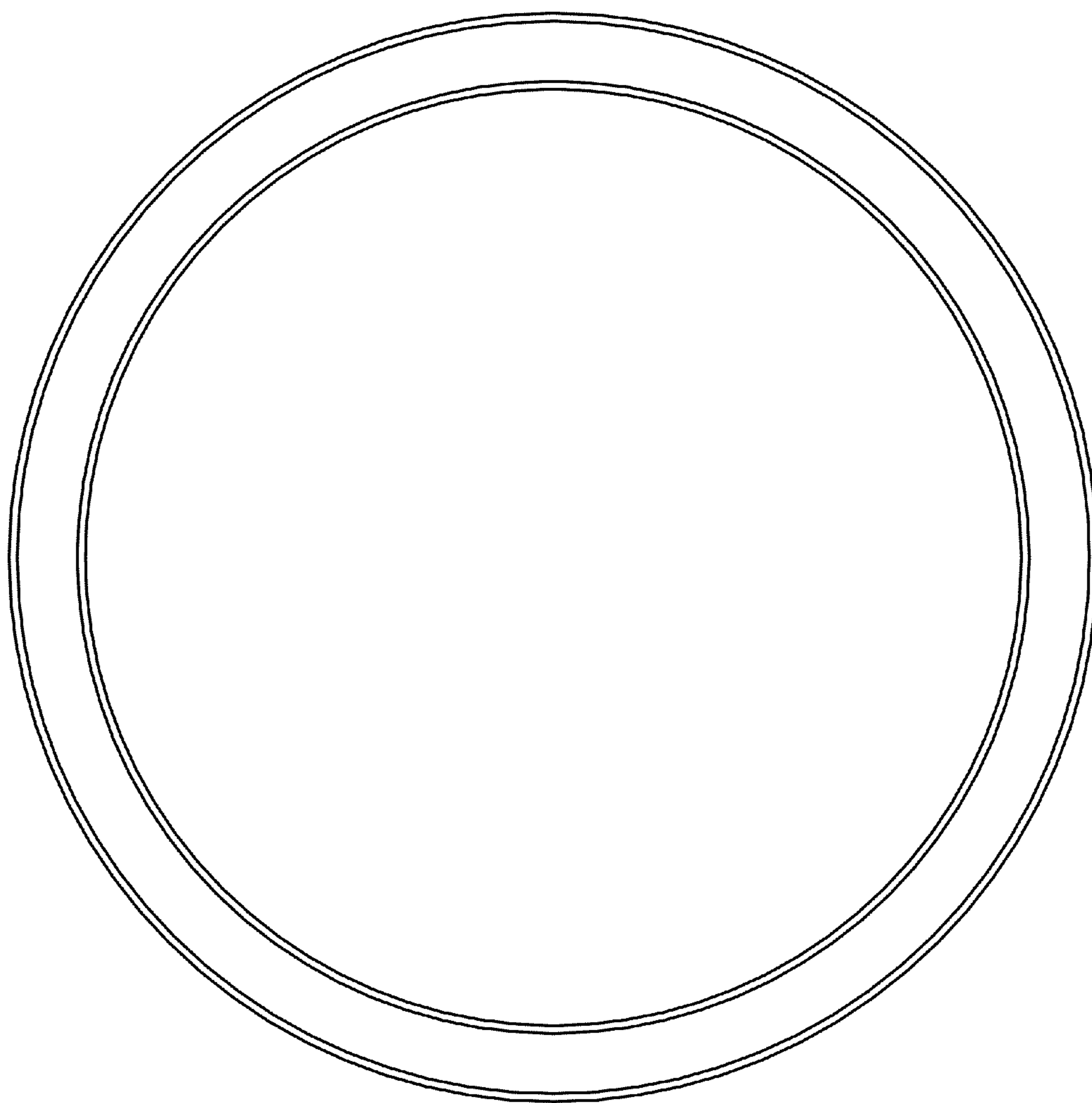

FIG. 9

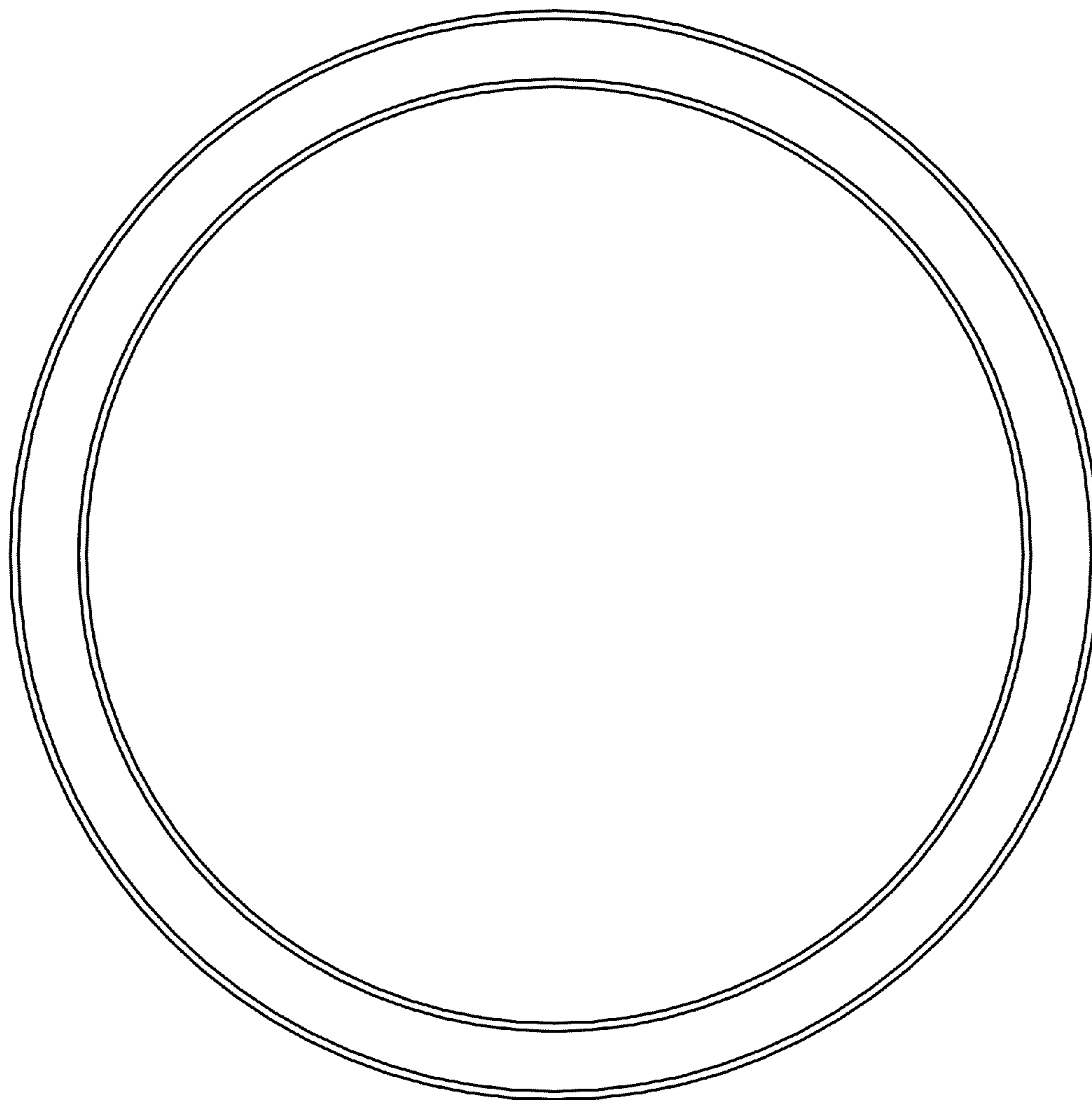

FIG. 10

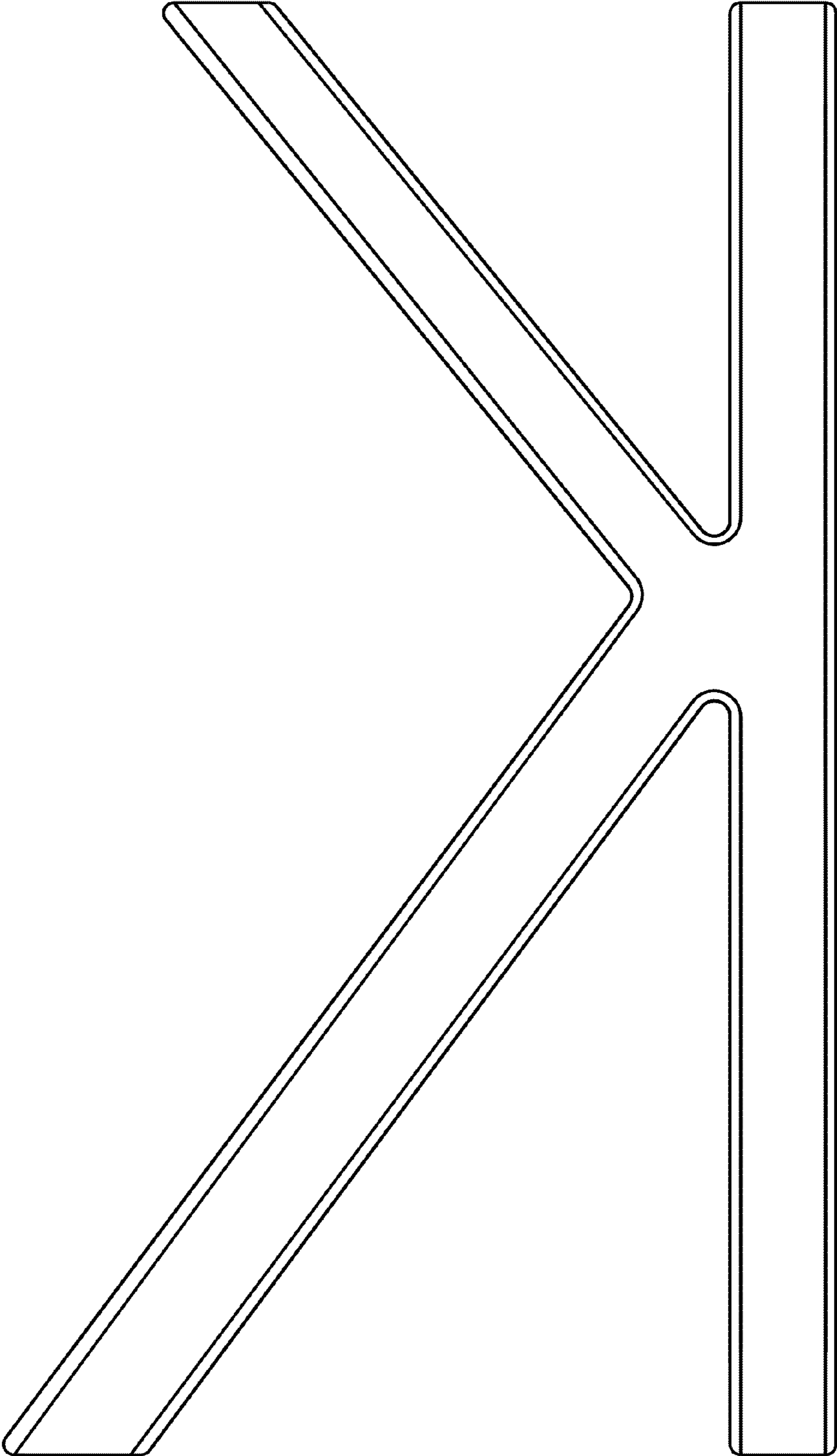

FIG. 11

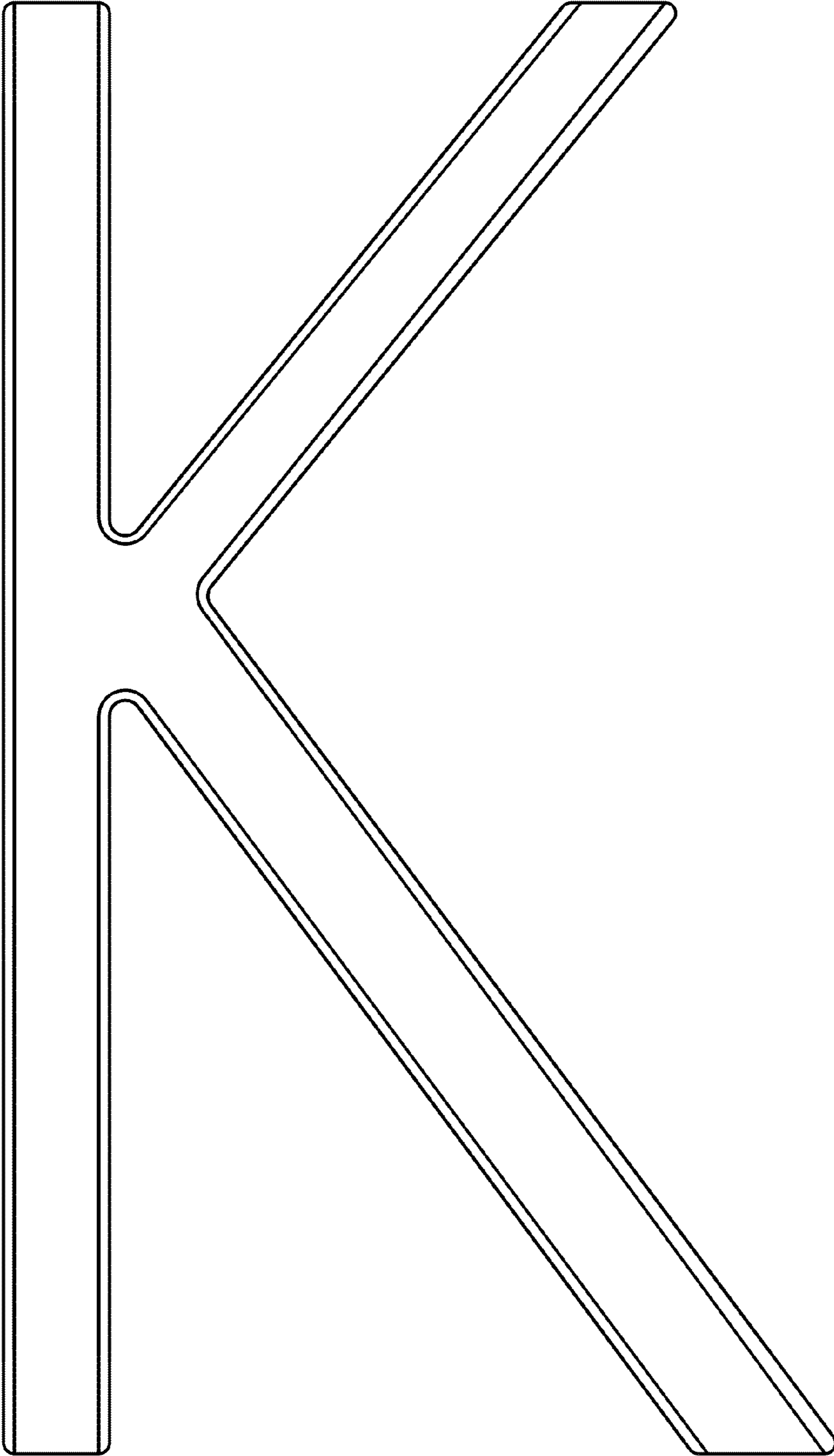

FIG. 12

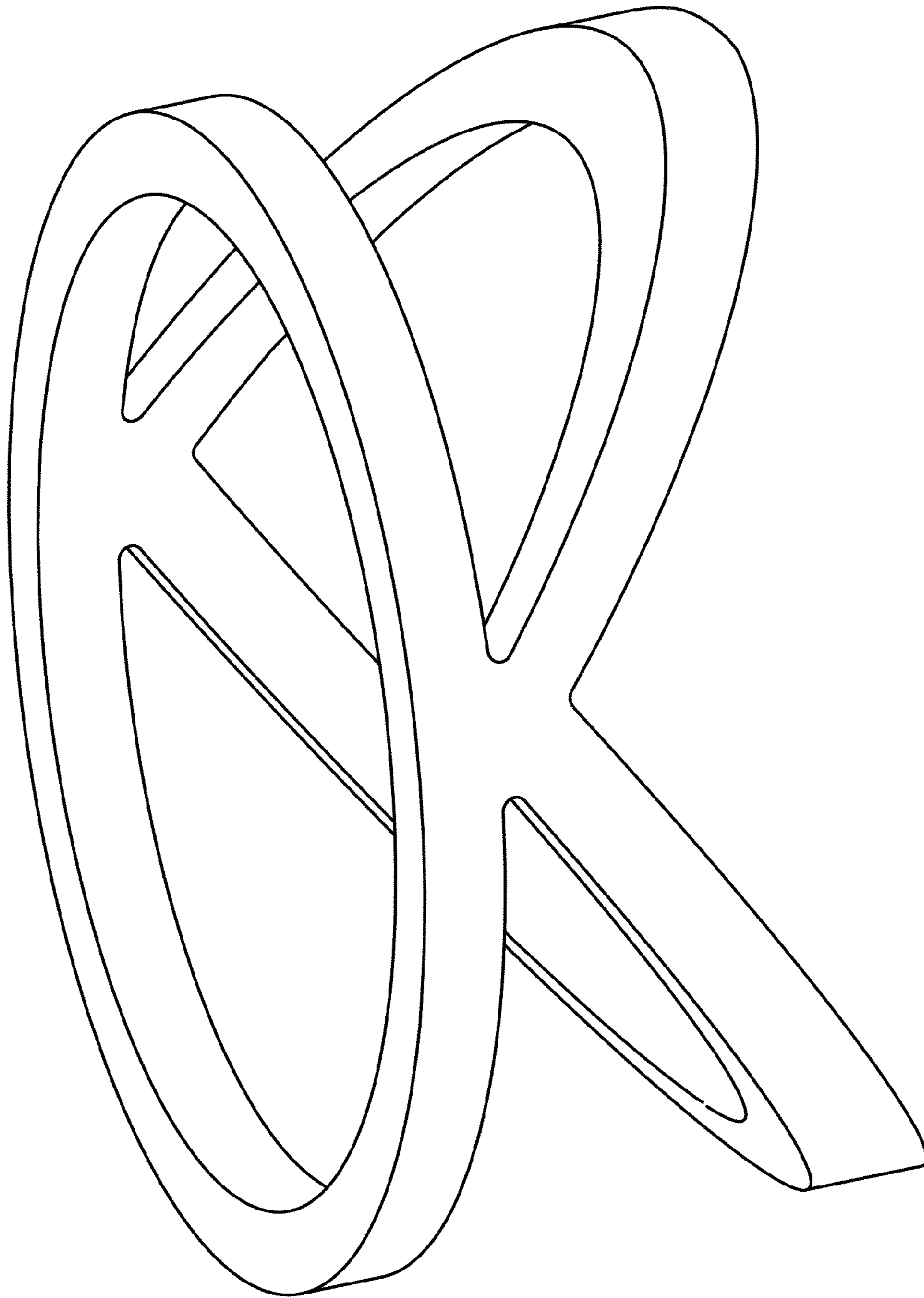

FIG. 13

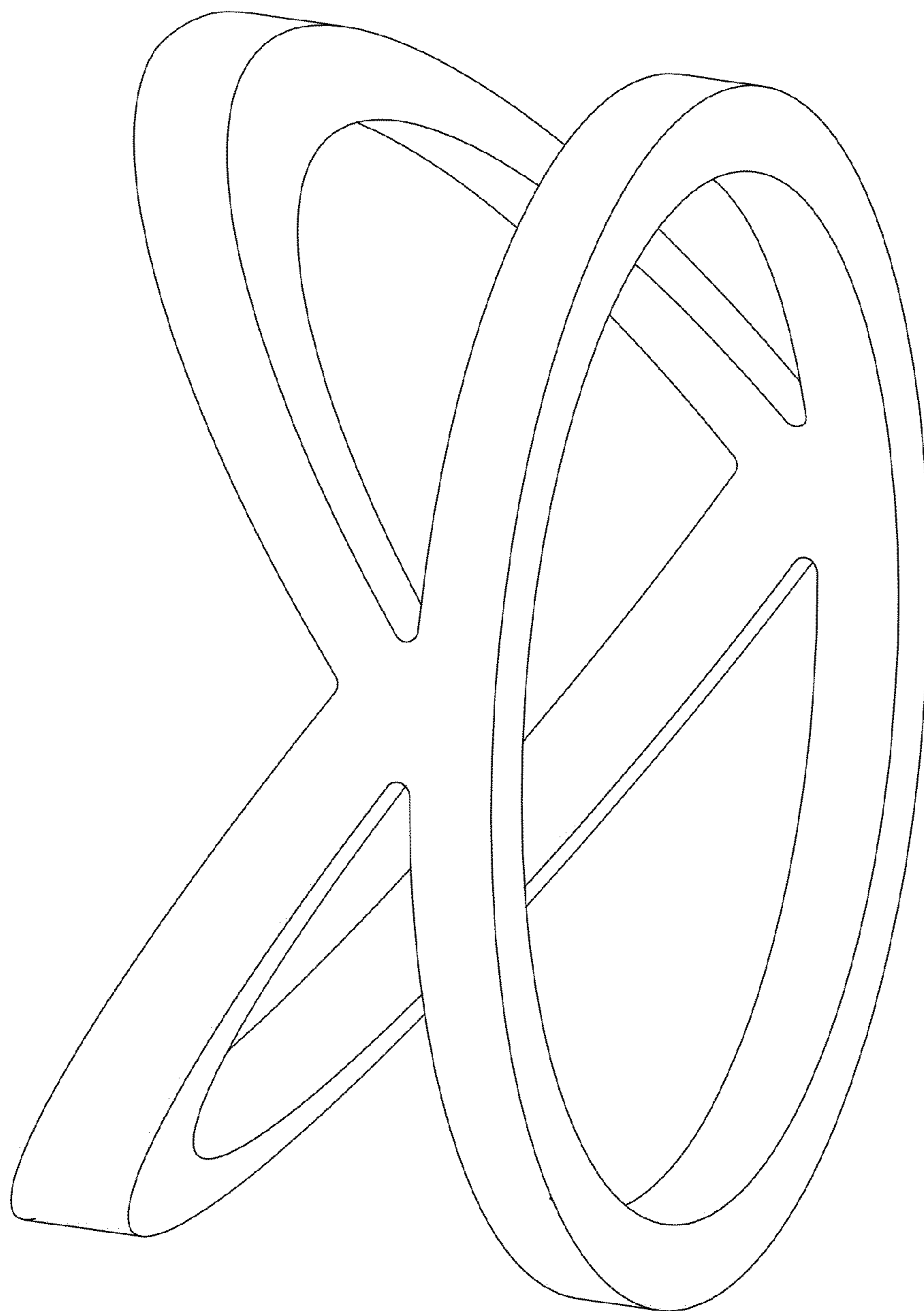

FIG. 14

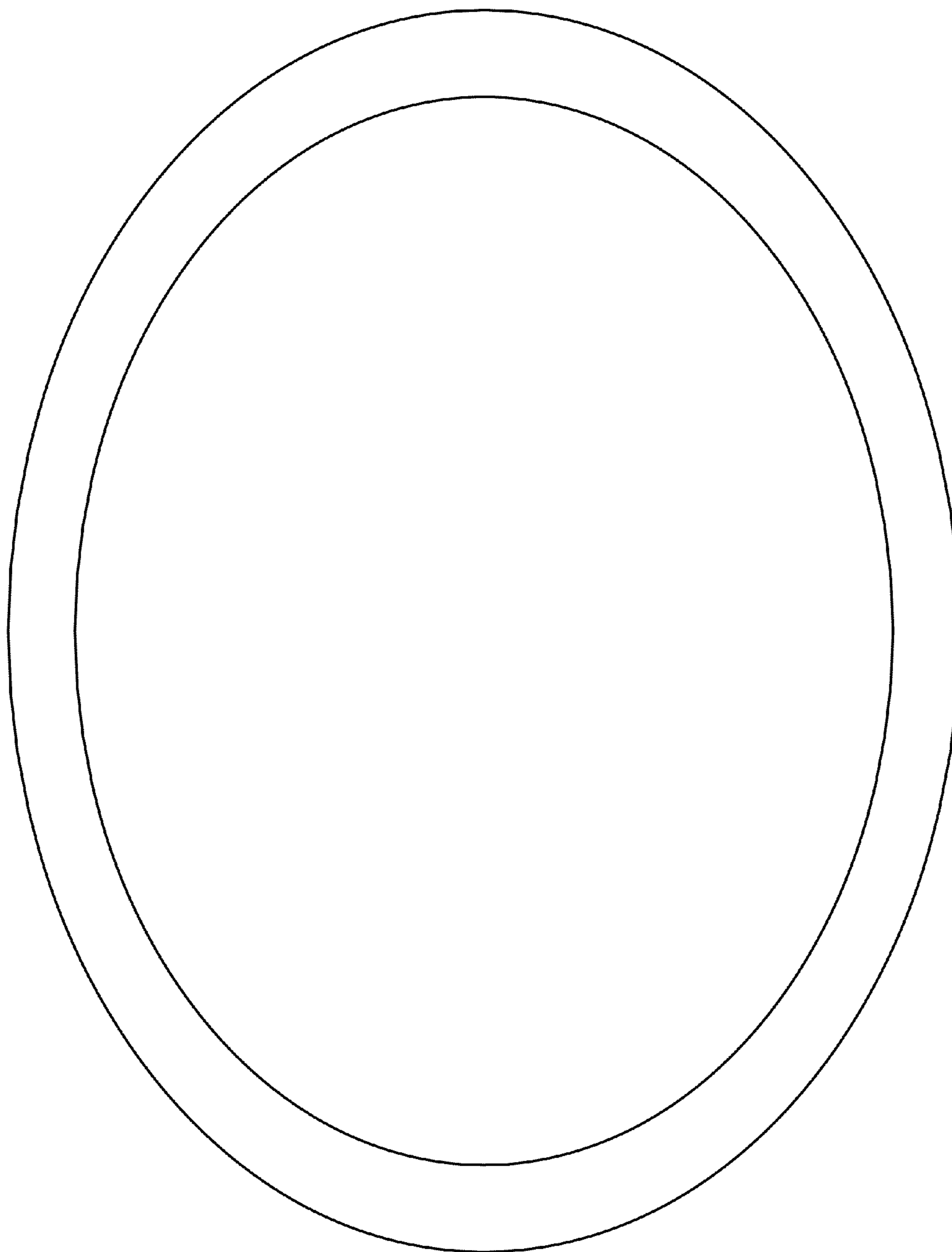

FIG. 15

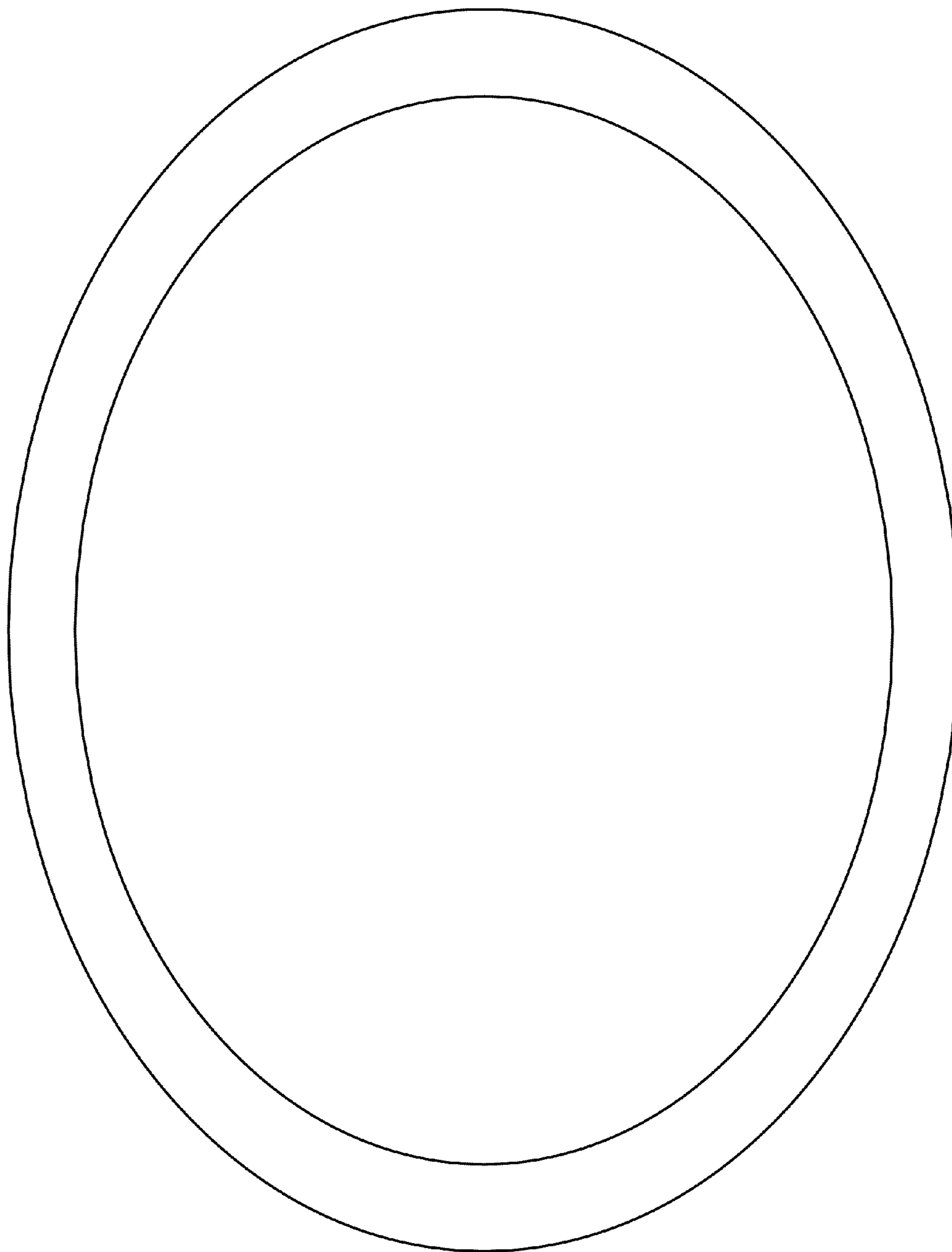

FIG. 16

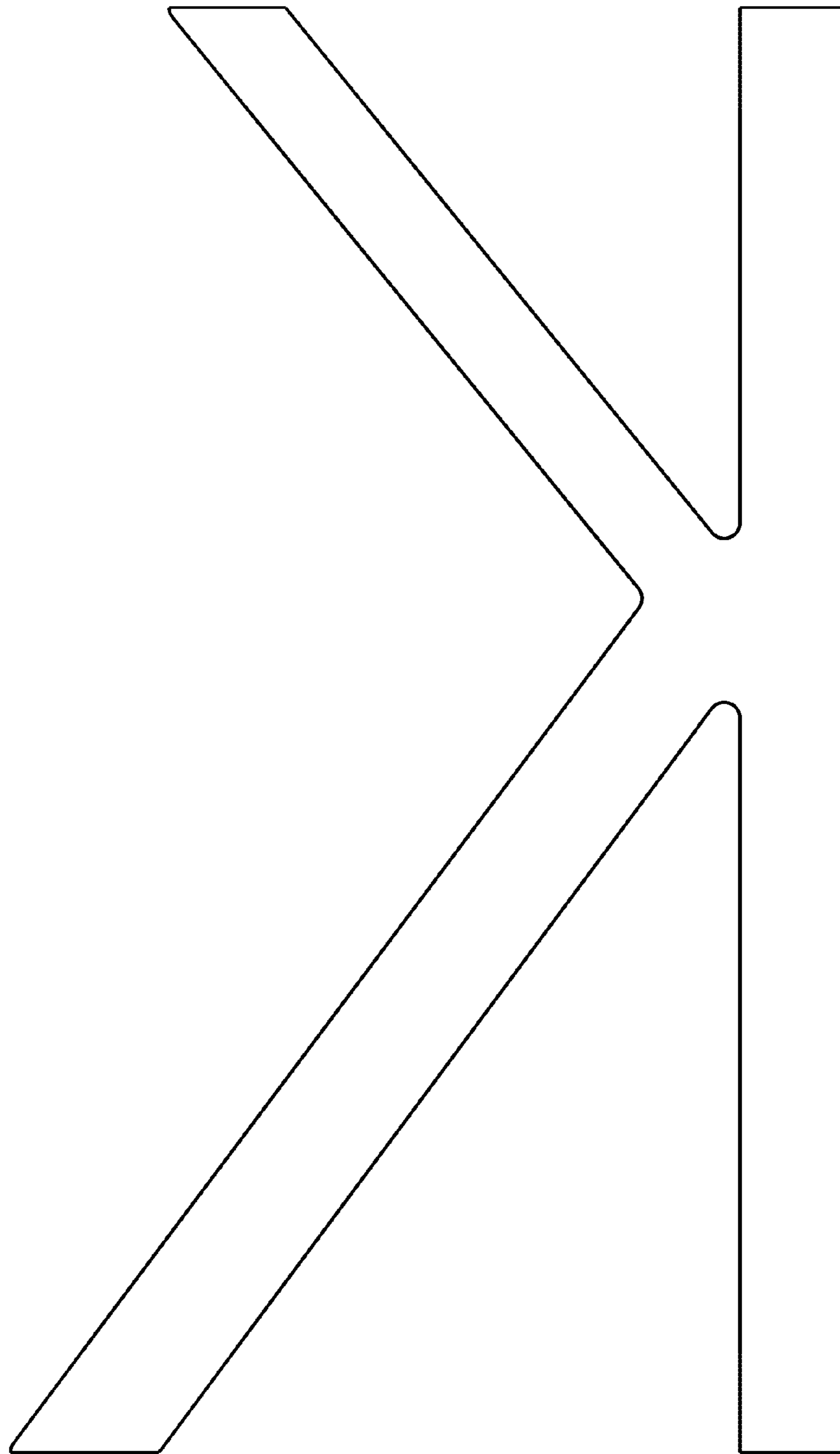

FIG. 17

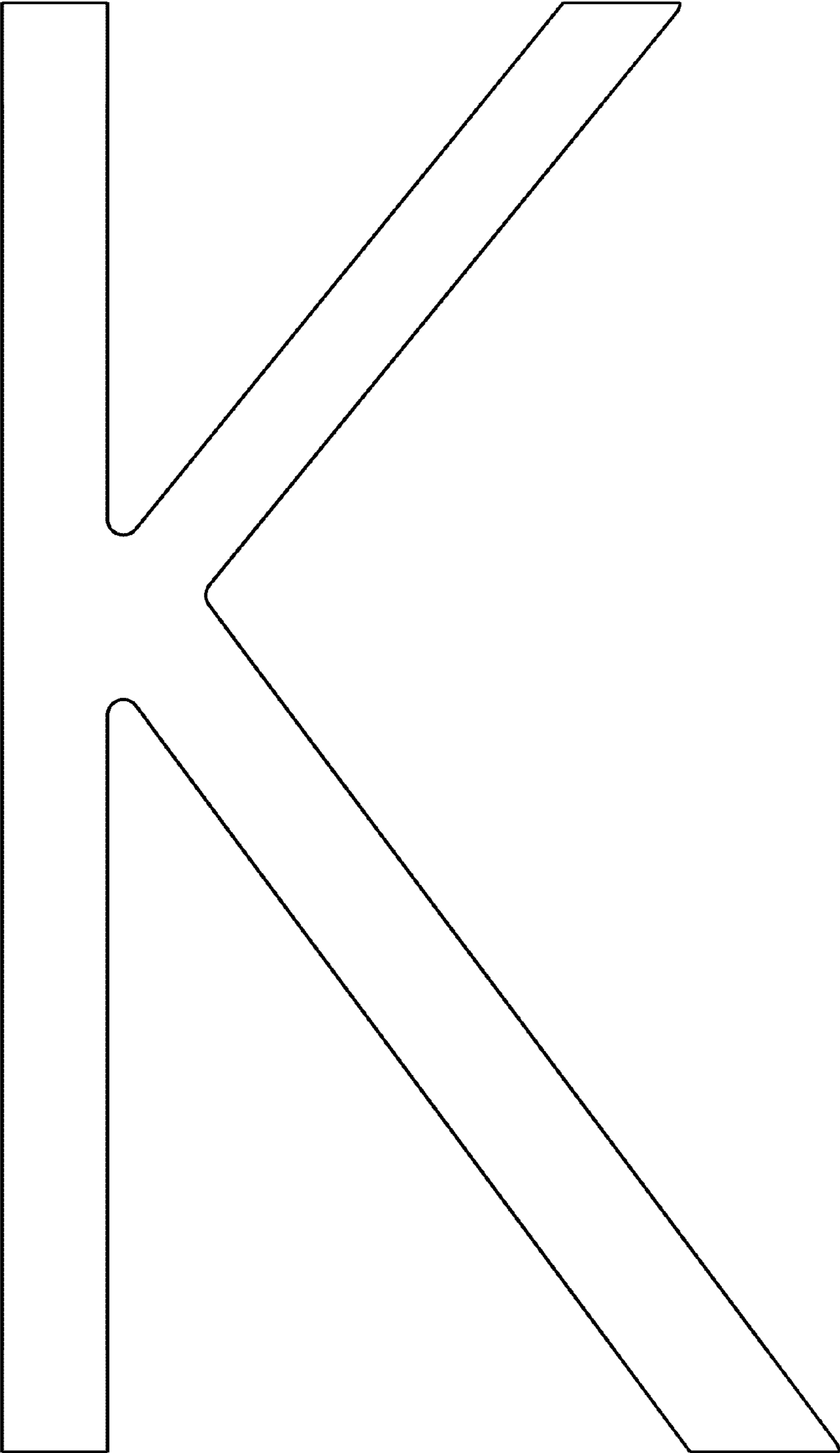

FIG. 18

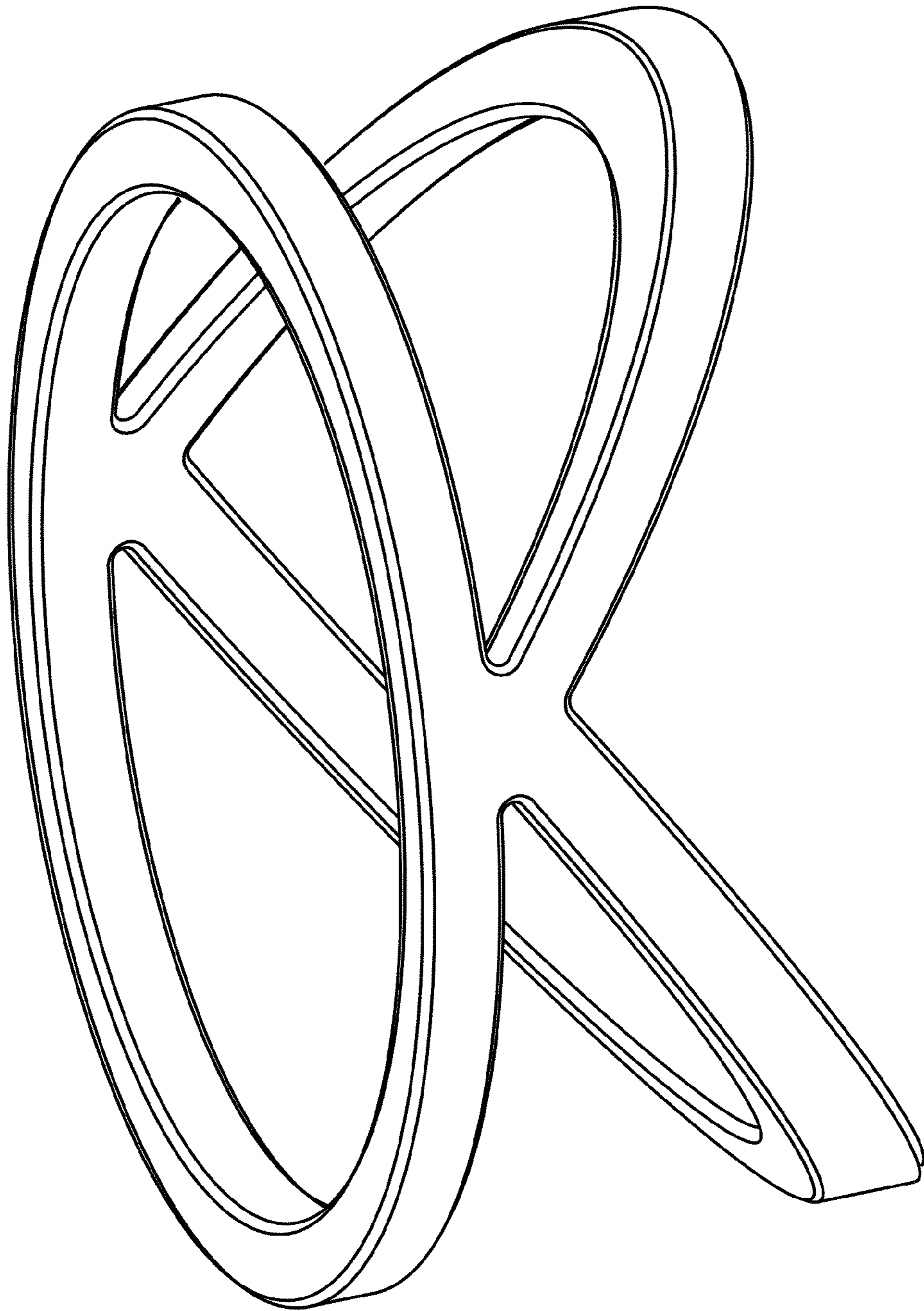

FIG. 19

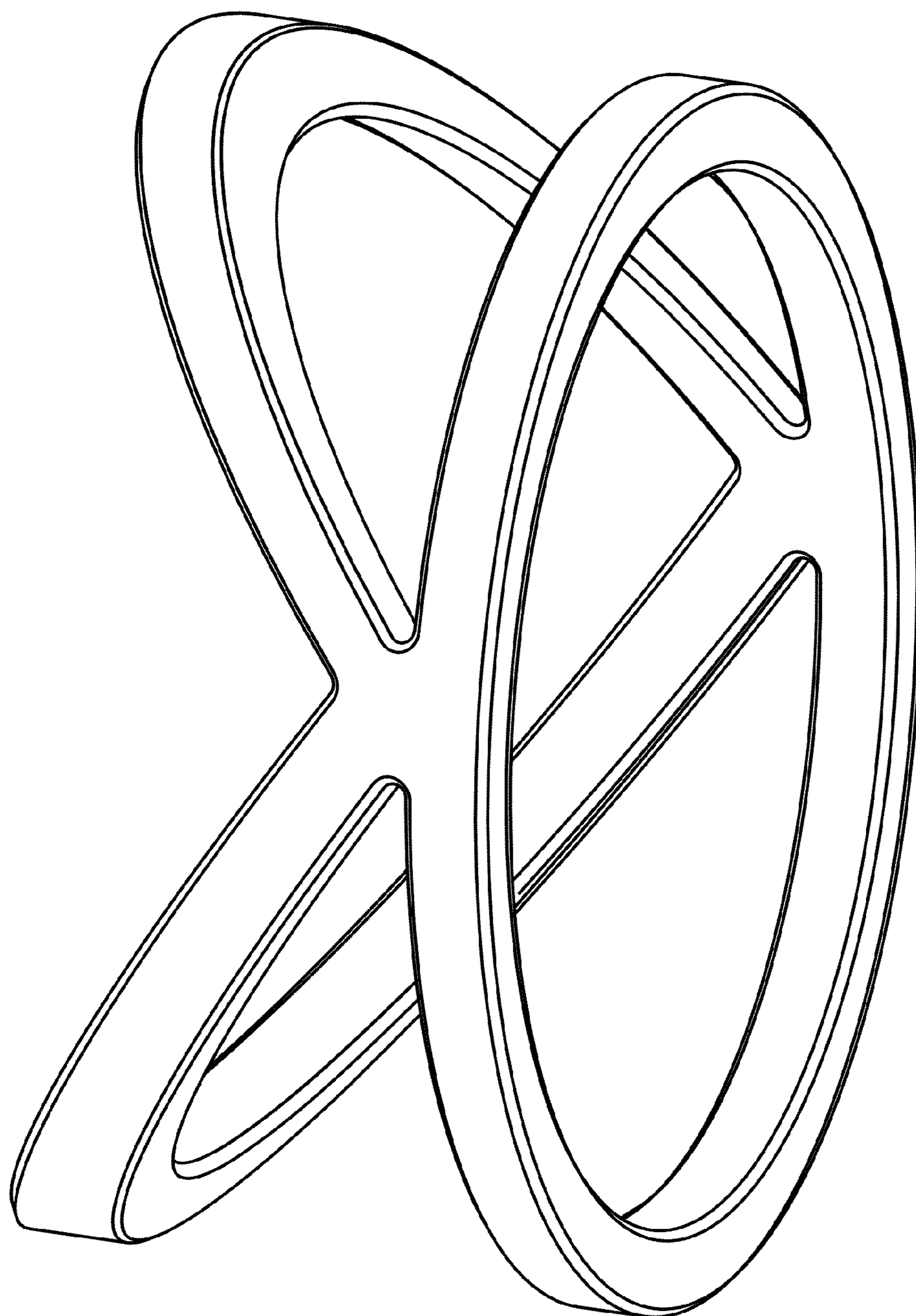

FIG. 20

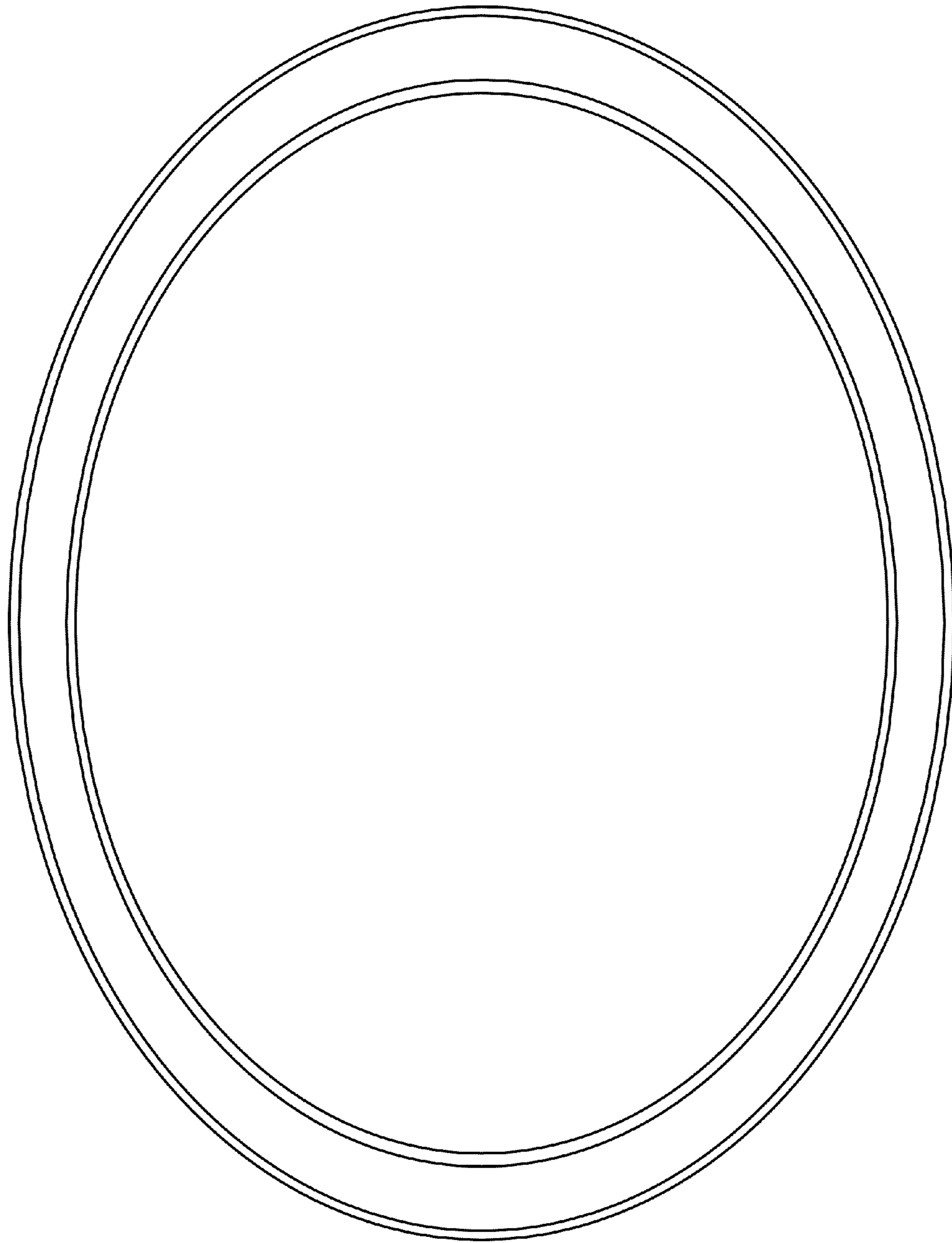

FIG. 21

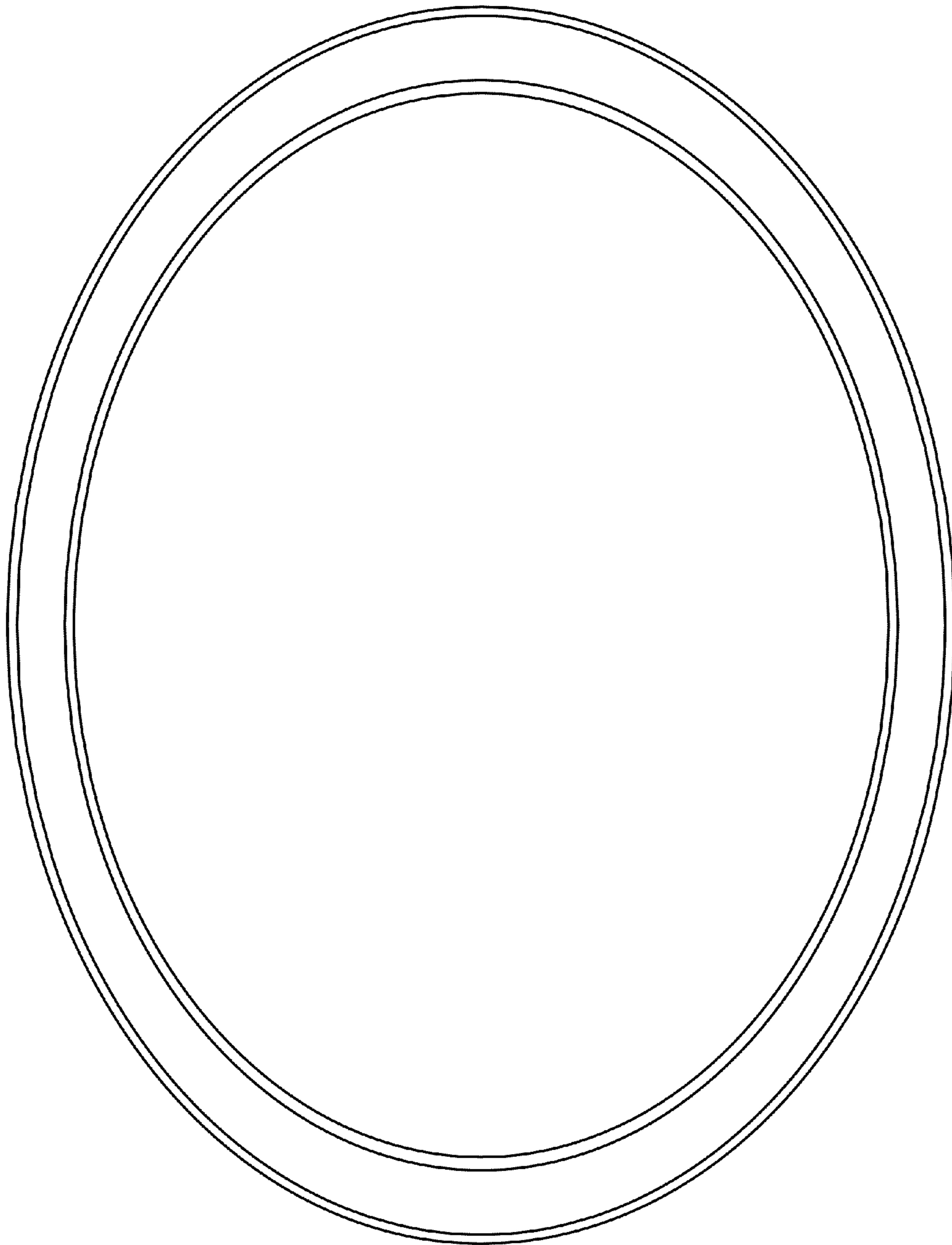

FIG. 22

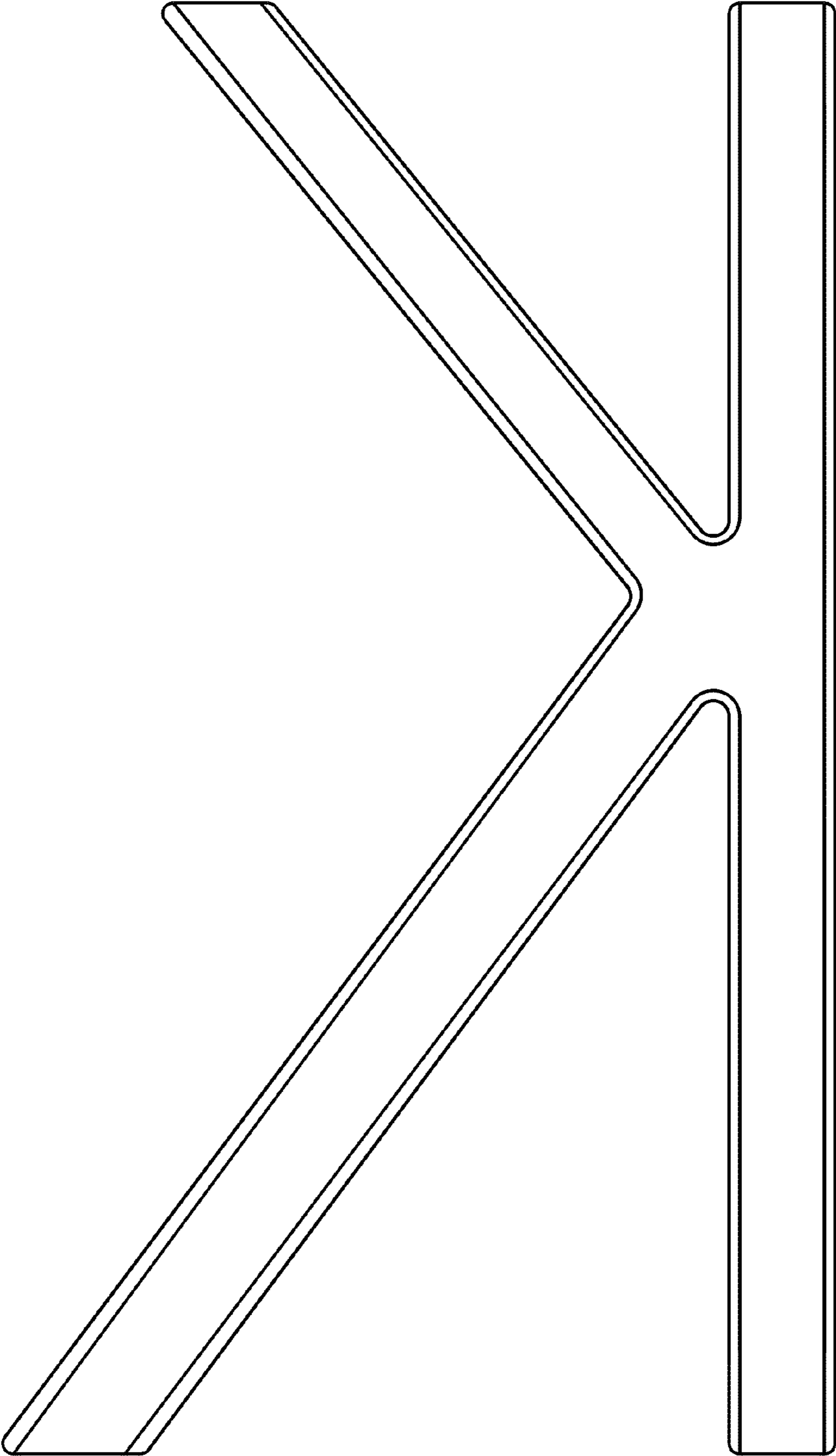

FIG. 23

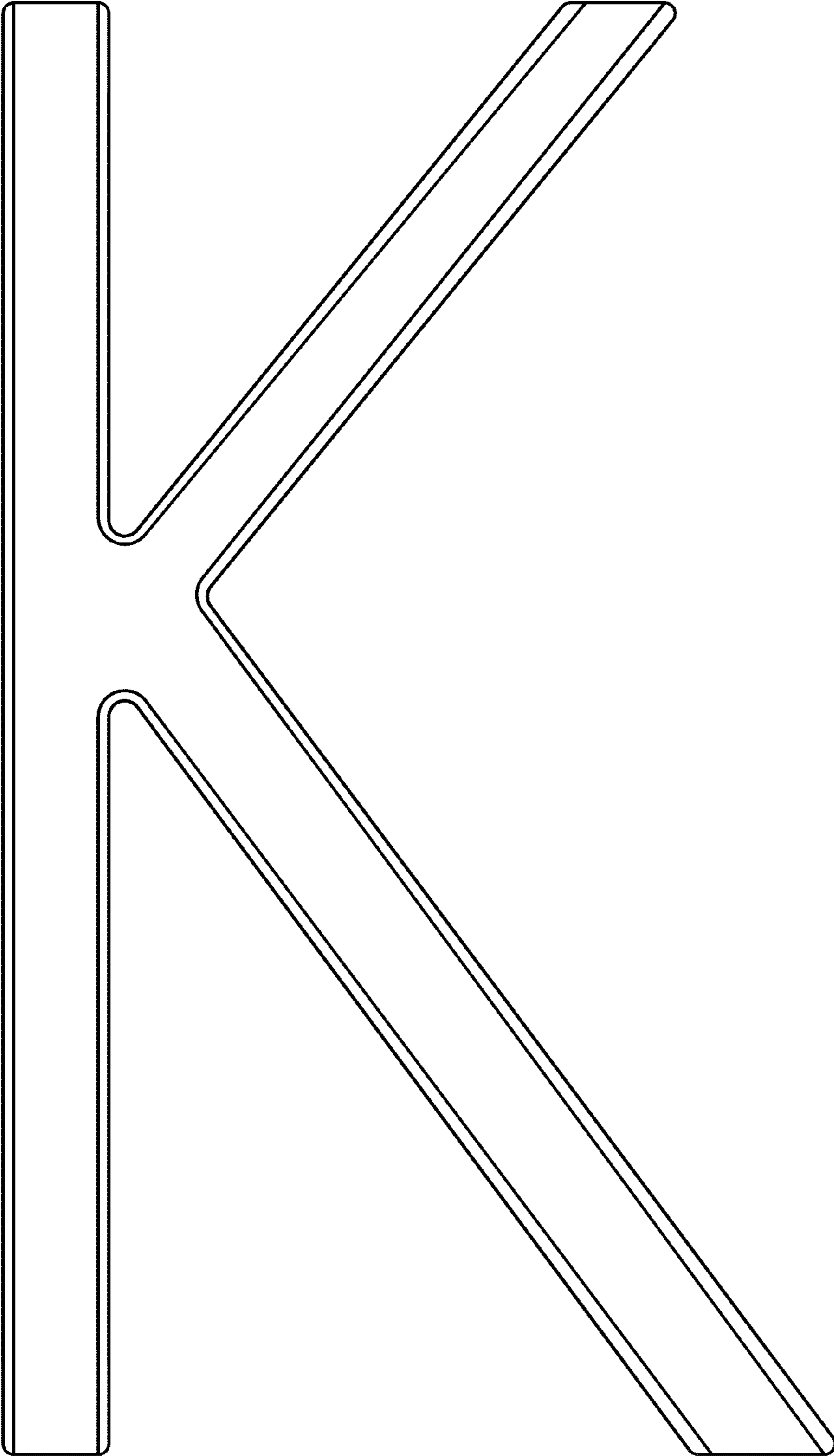

FIG. 24

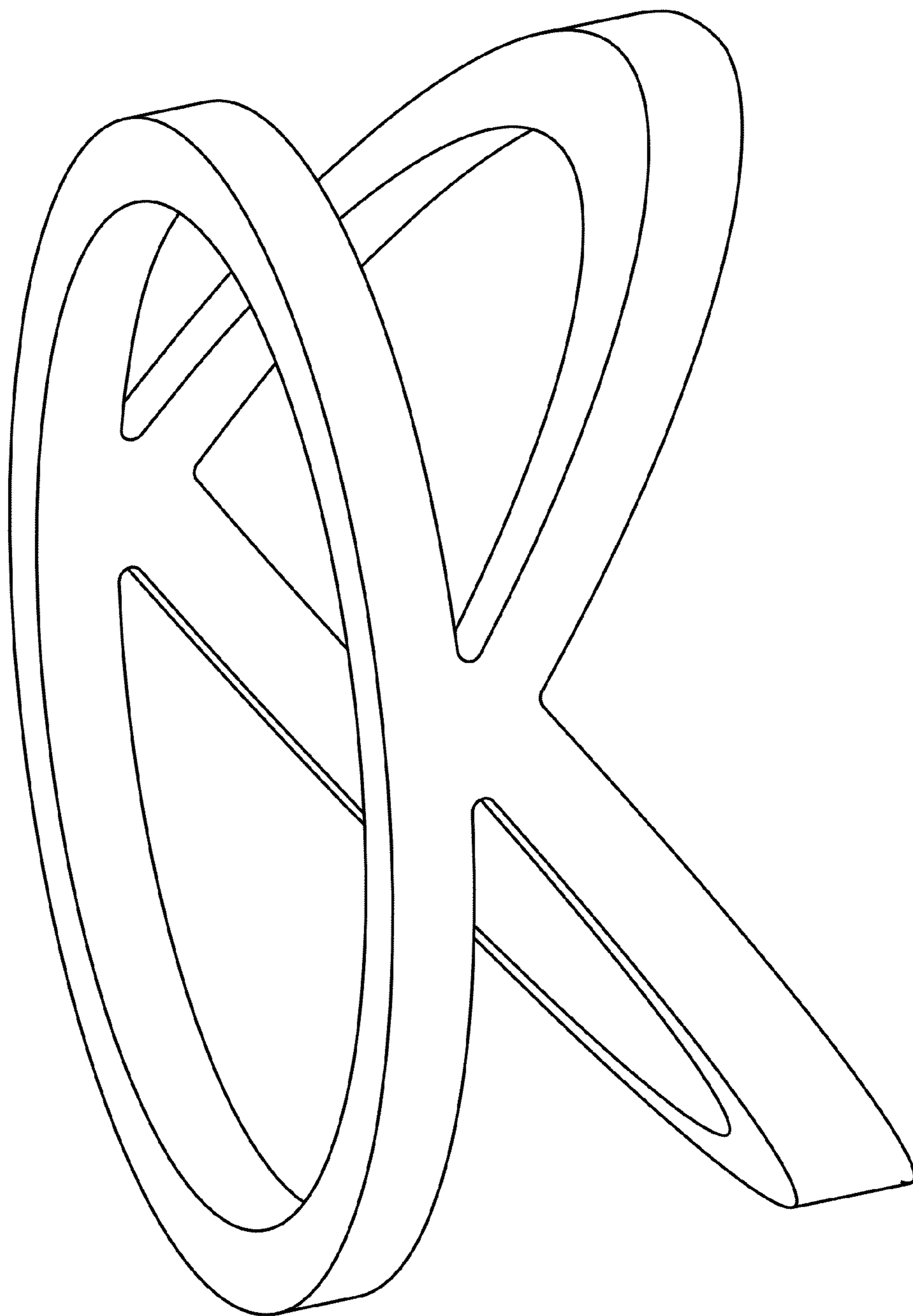

FIG. 25

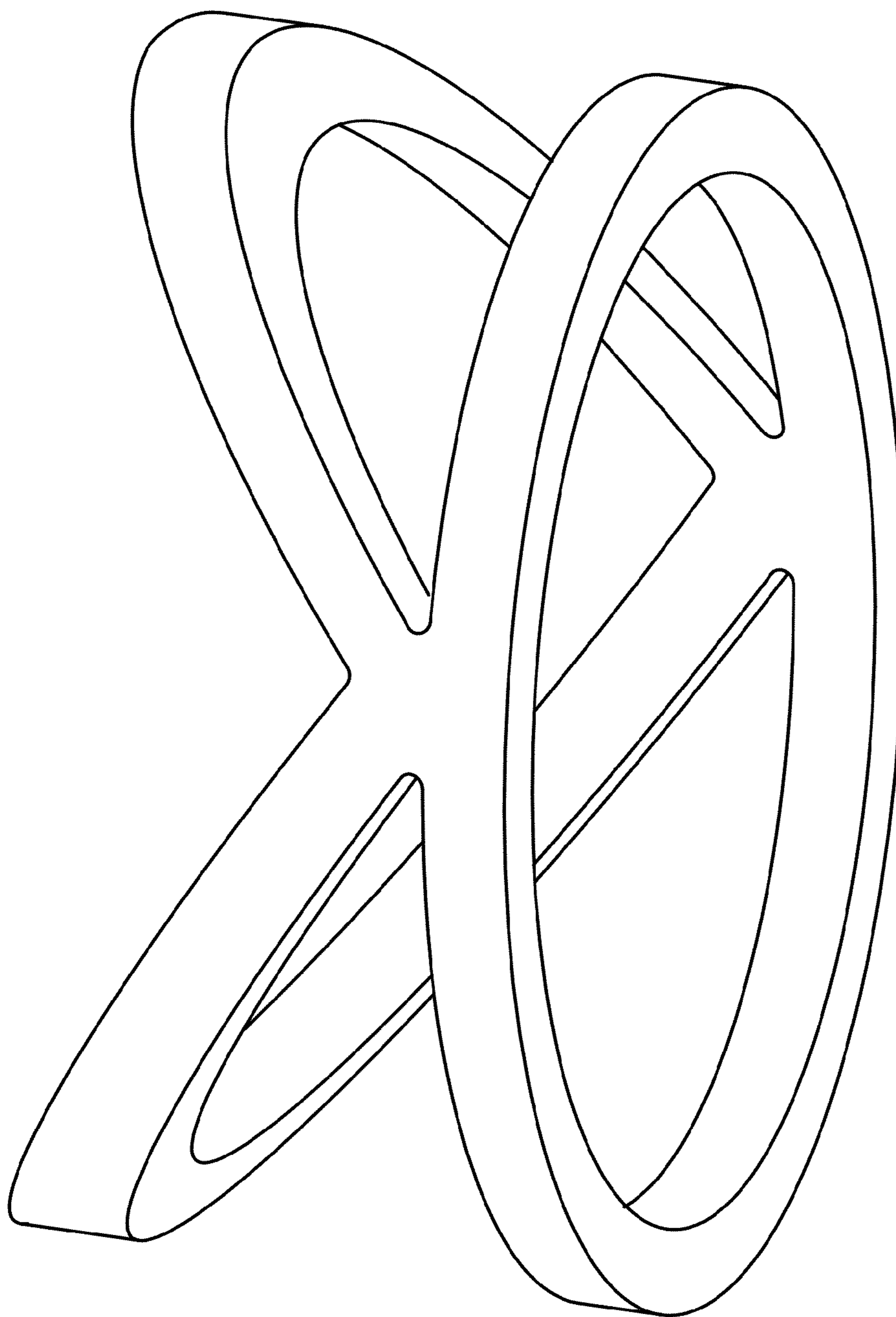

FIG. 26

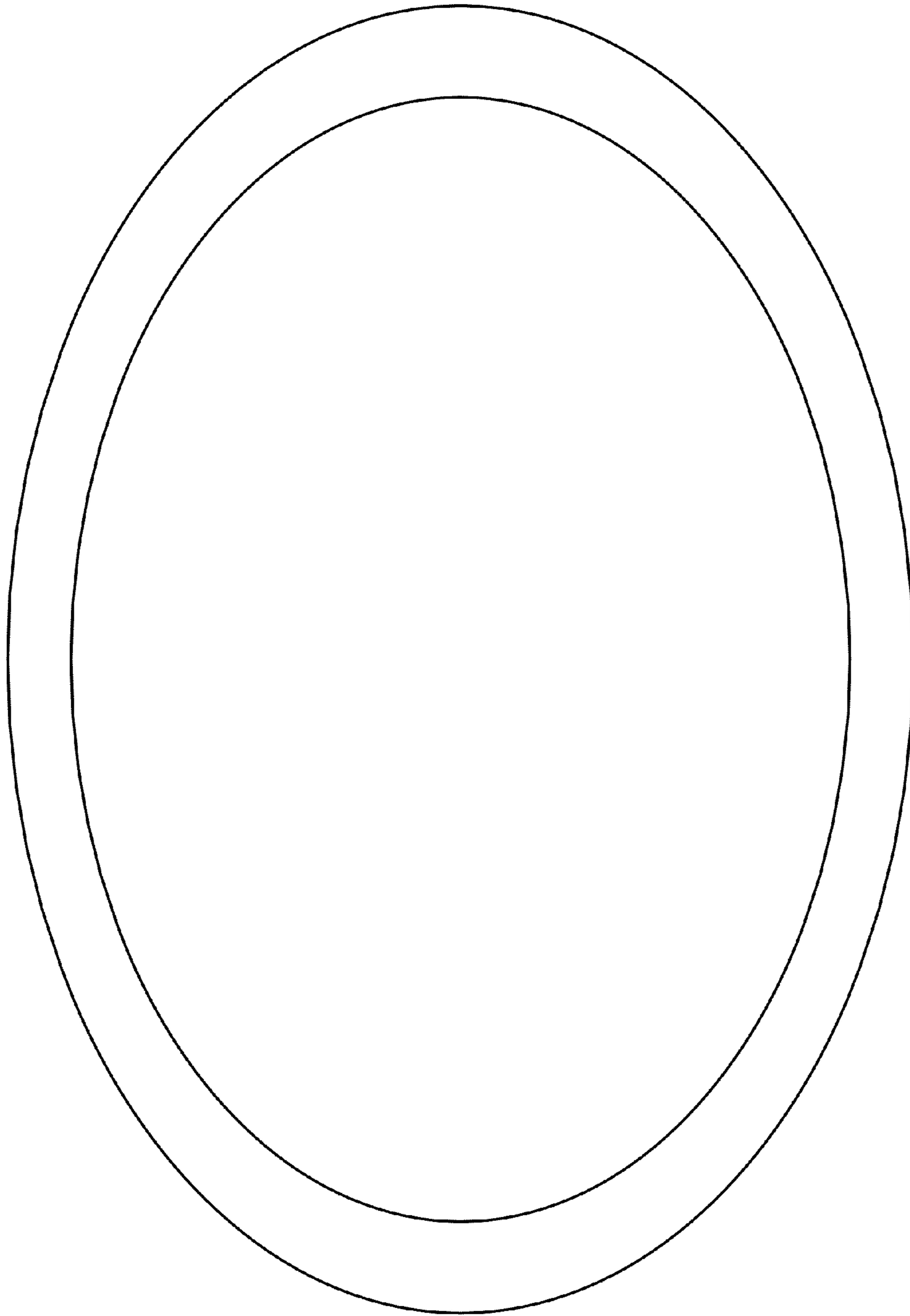

FIG. 27

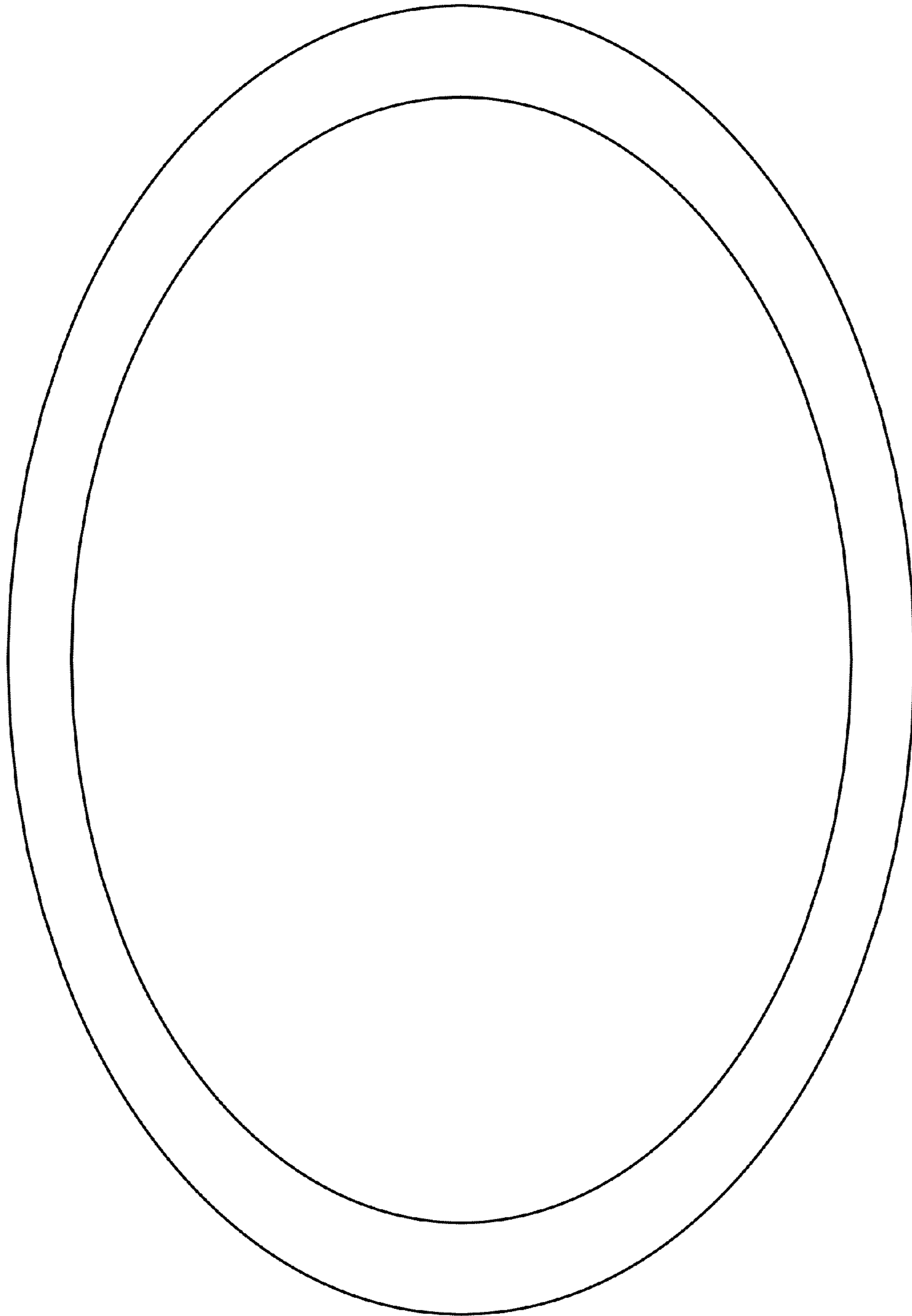

FIG. 28

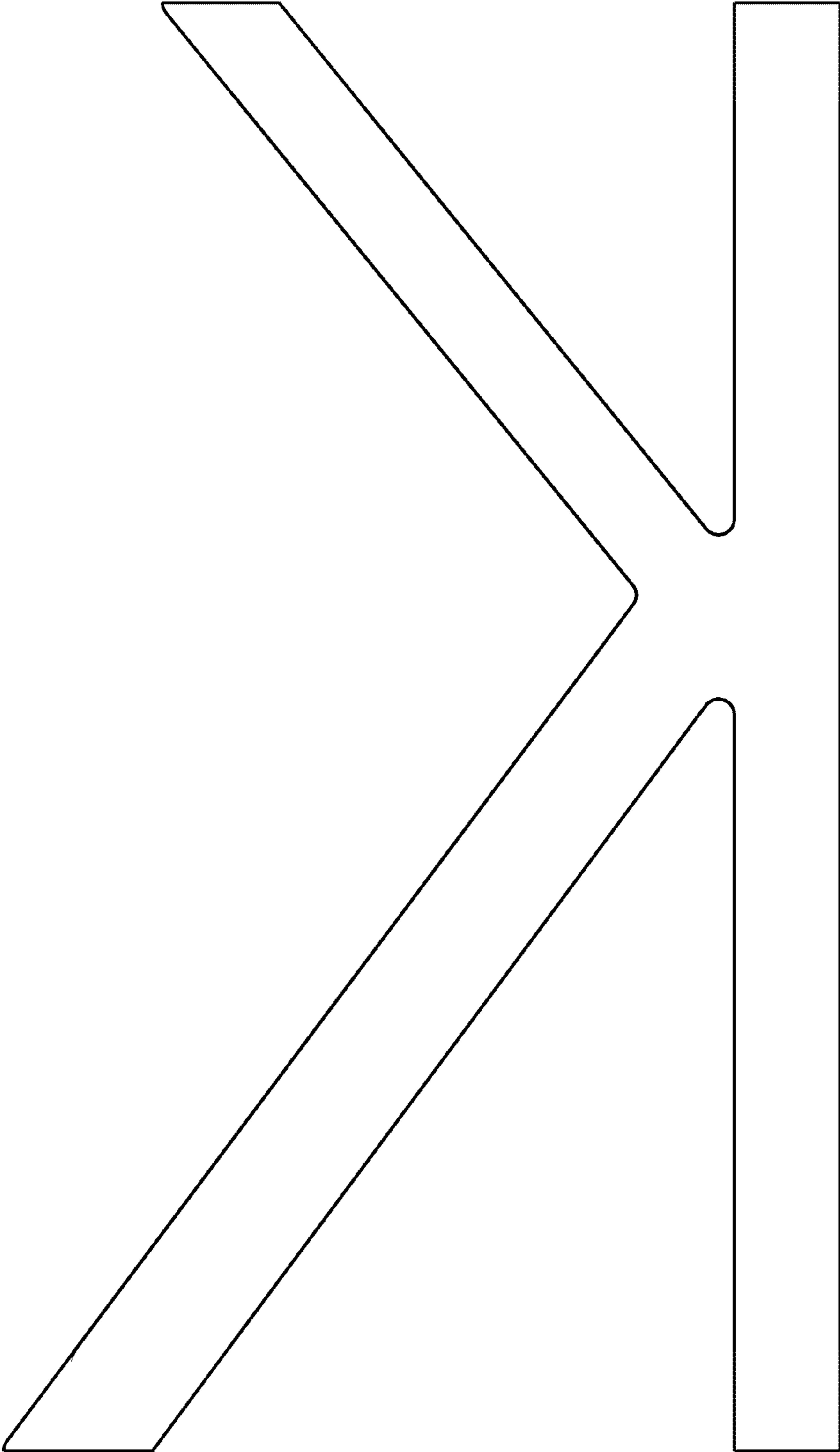

FIG. 29

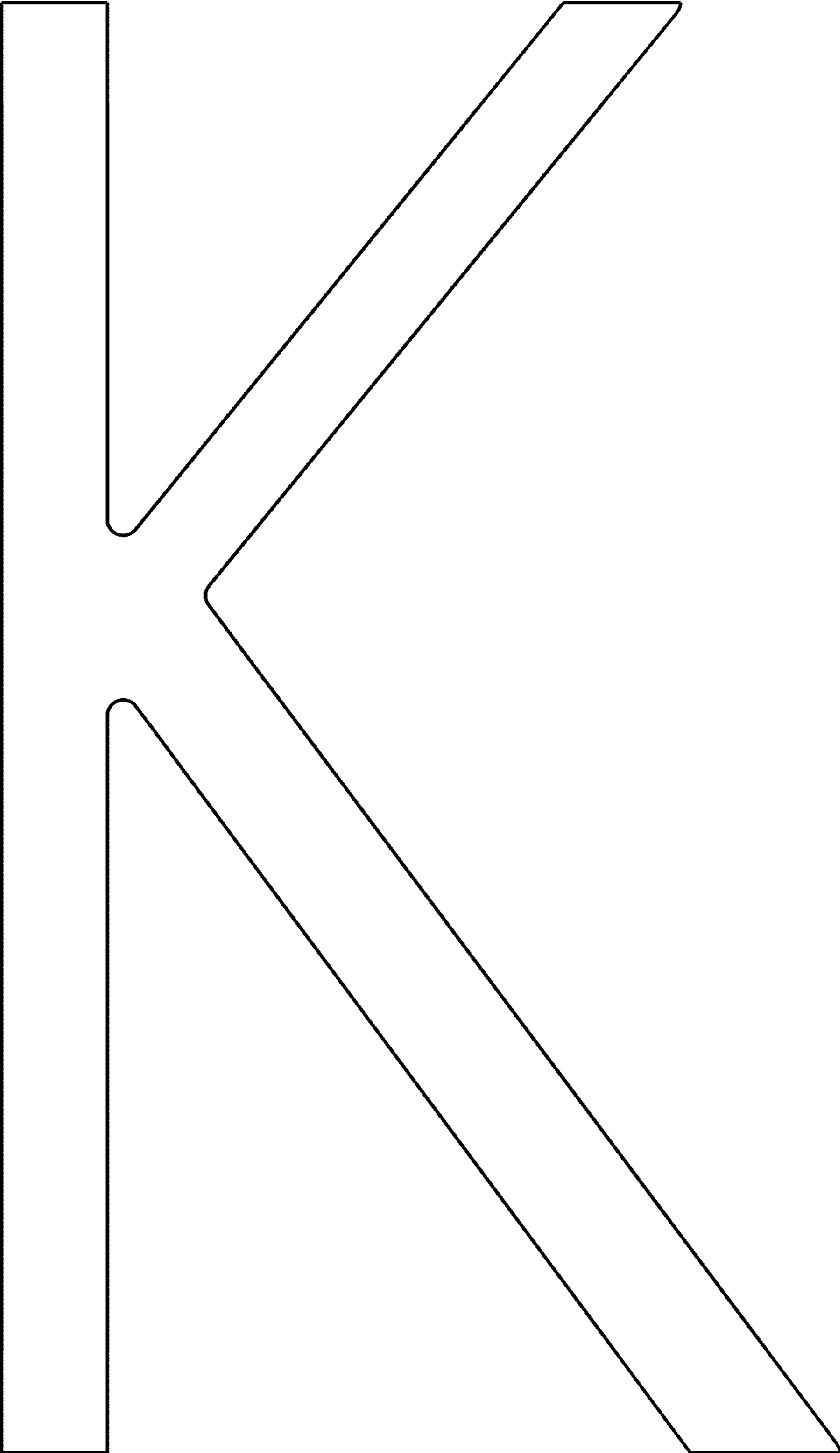

FIG. 30

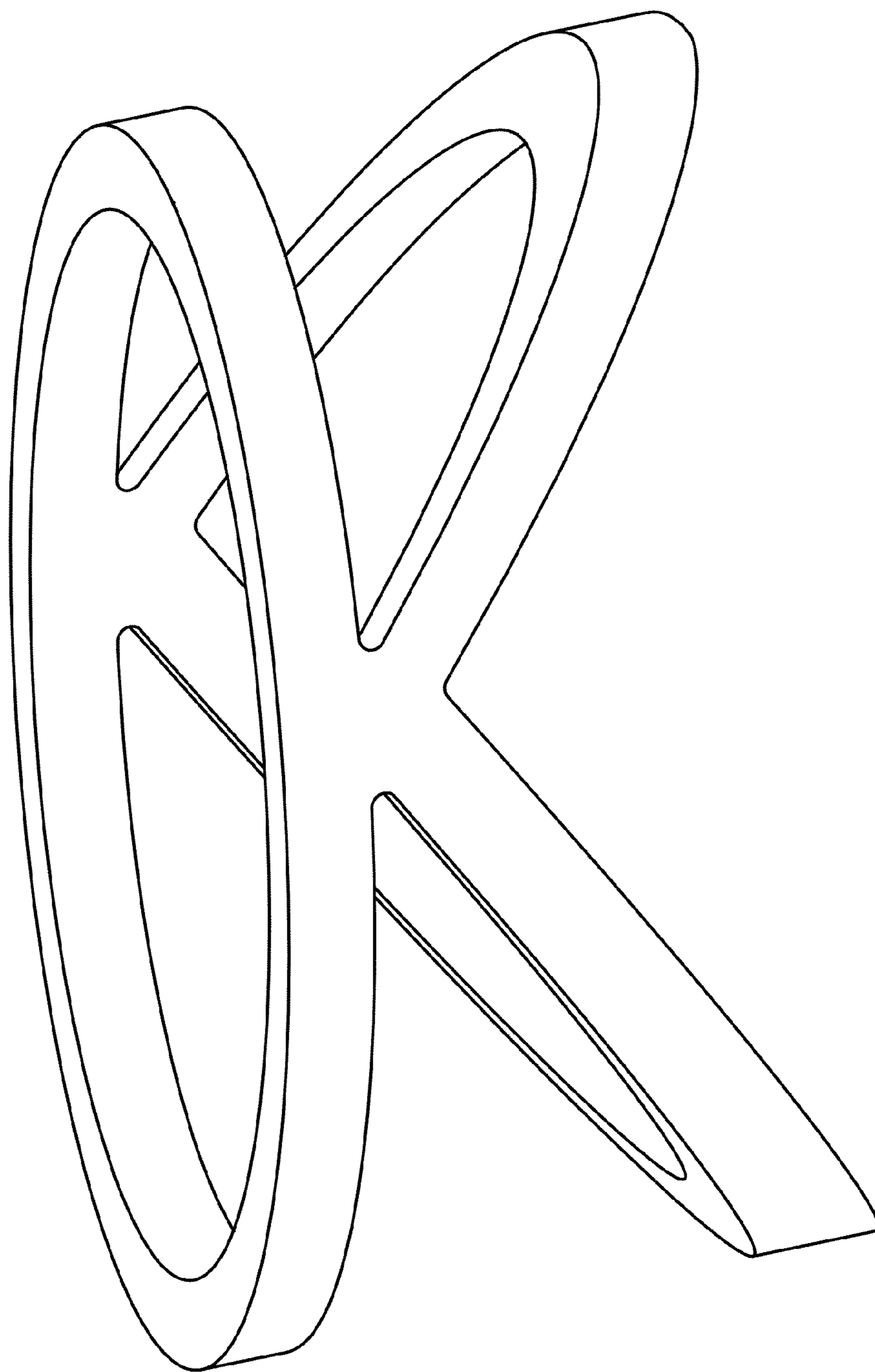

FIG. 31

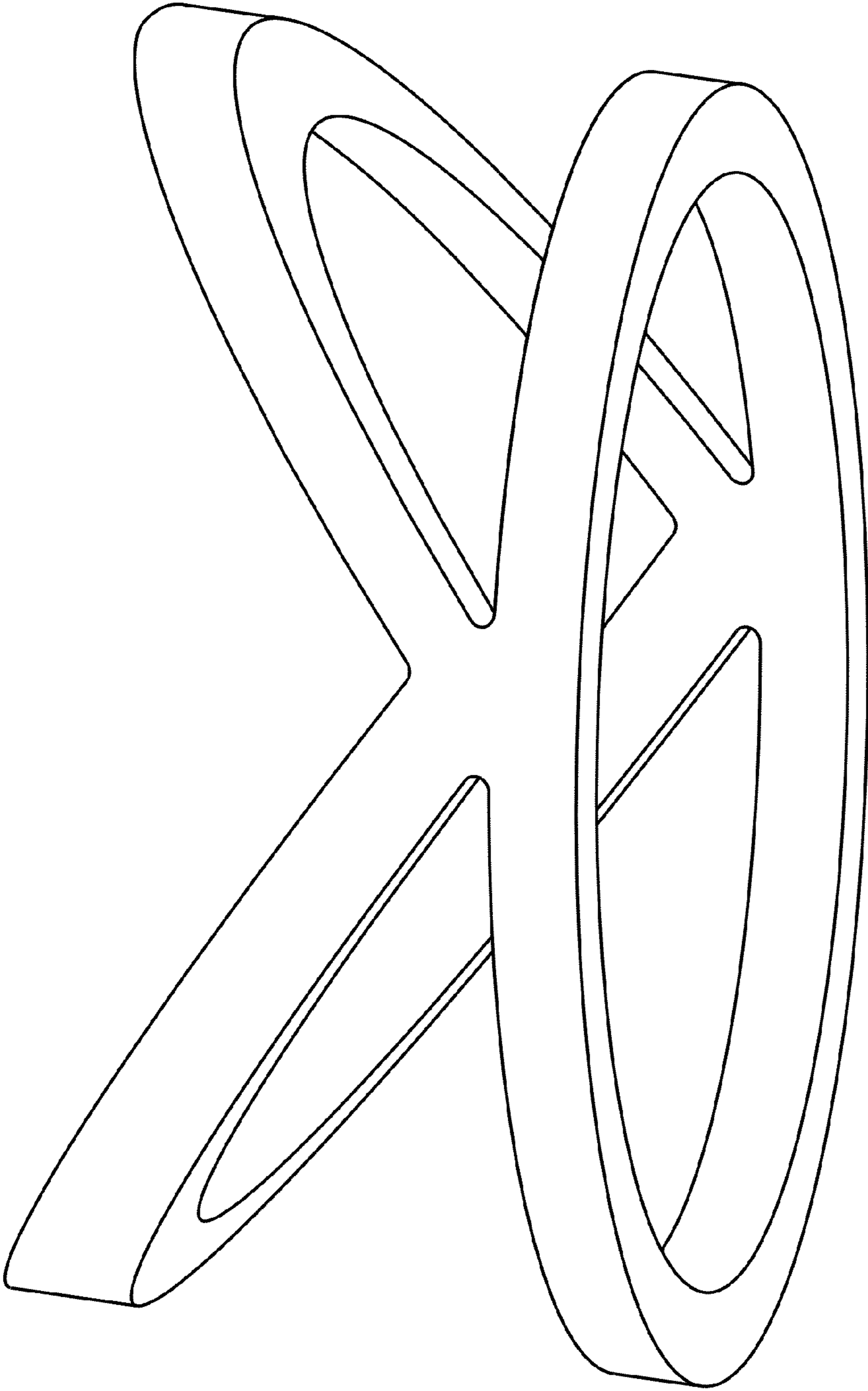

FIG. 32

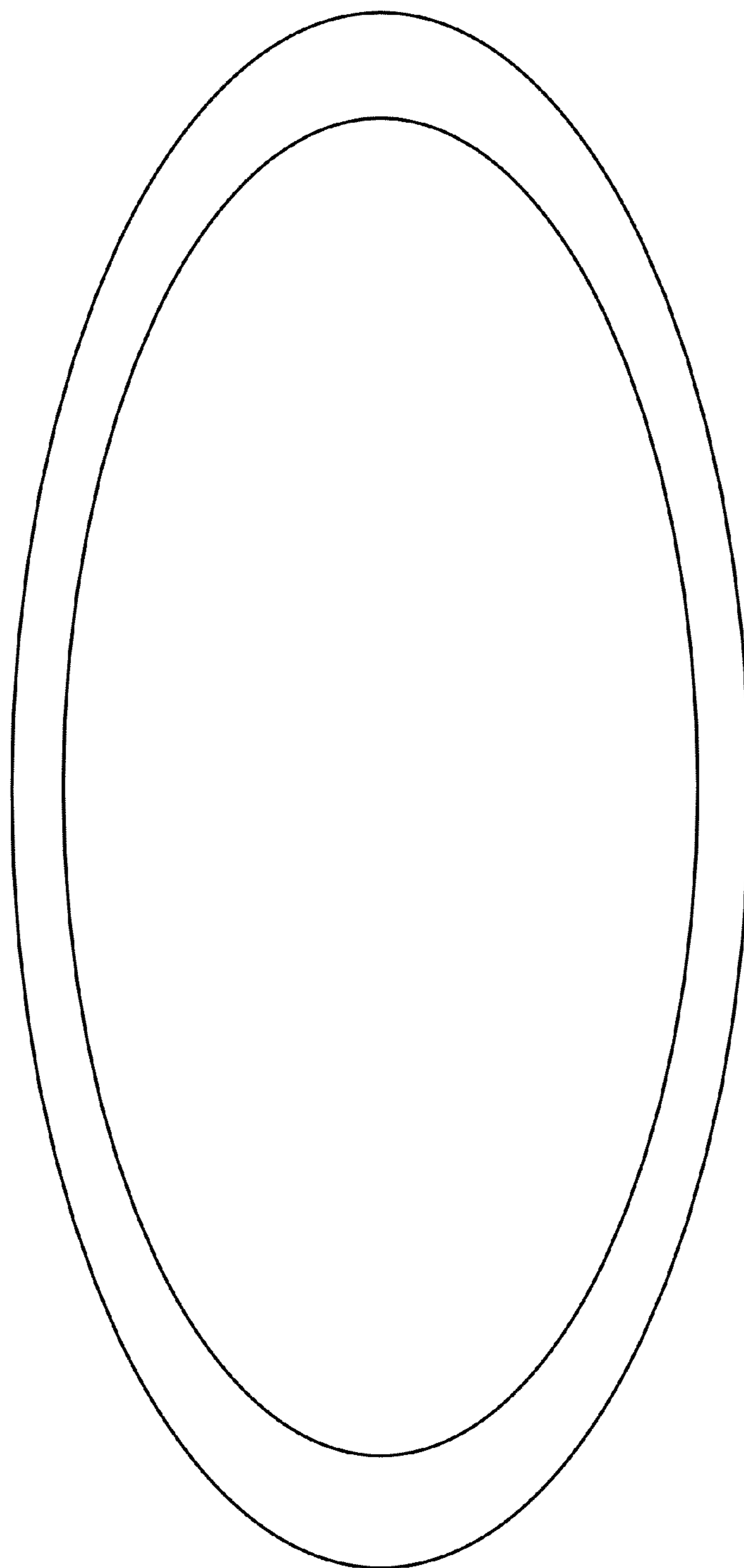

FIG. 33

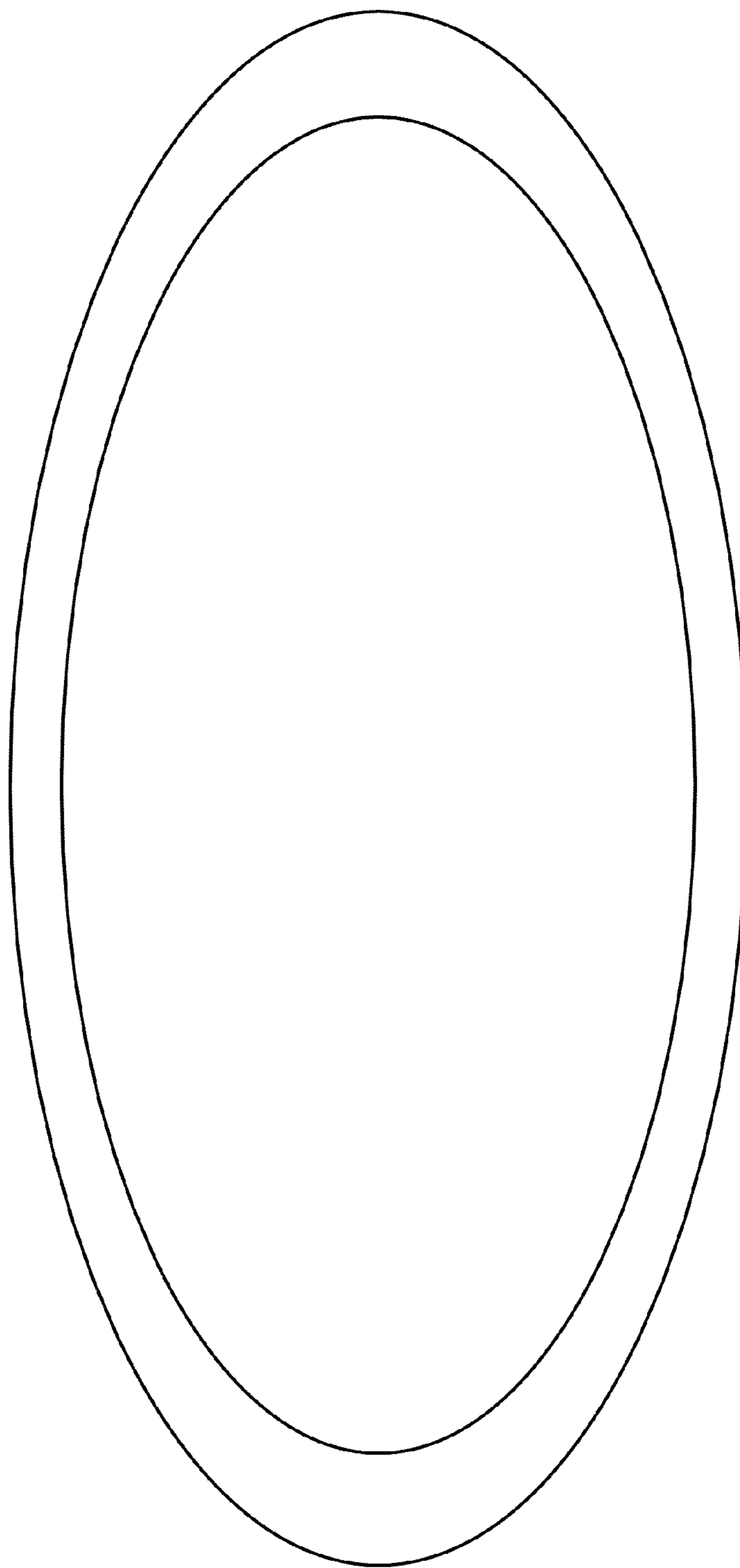

FIG. 34

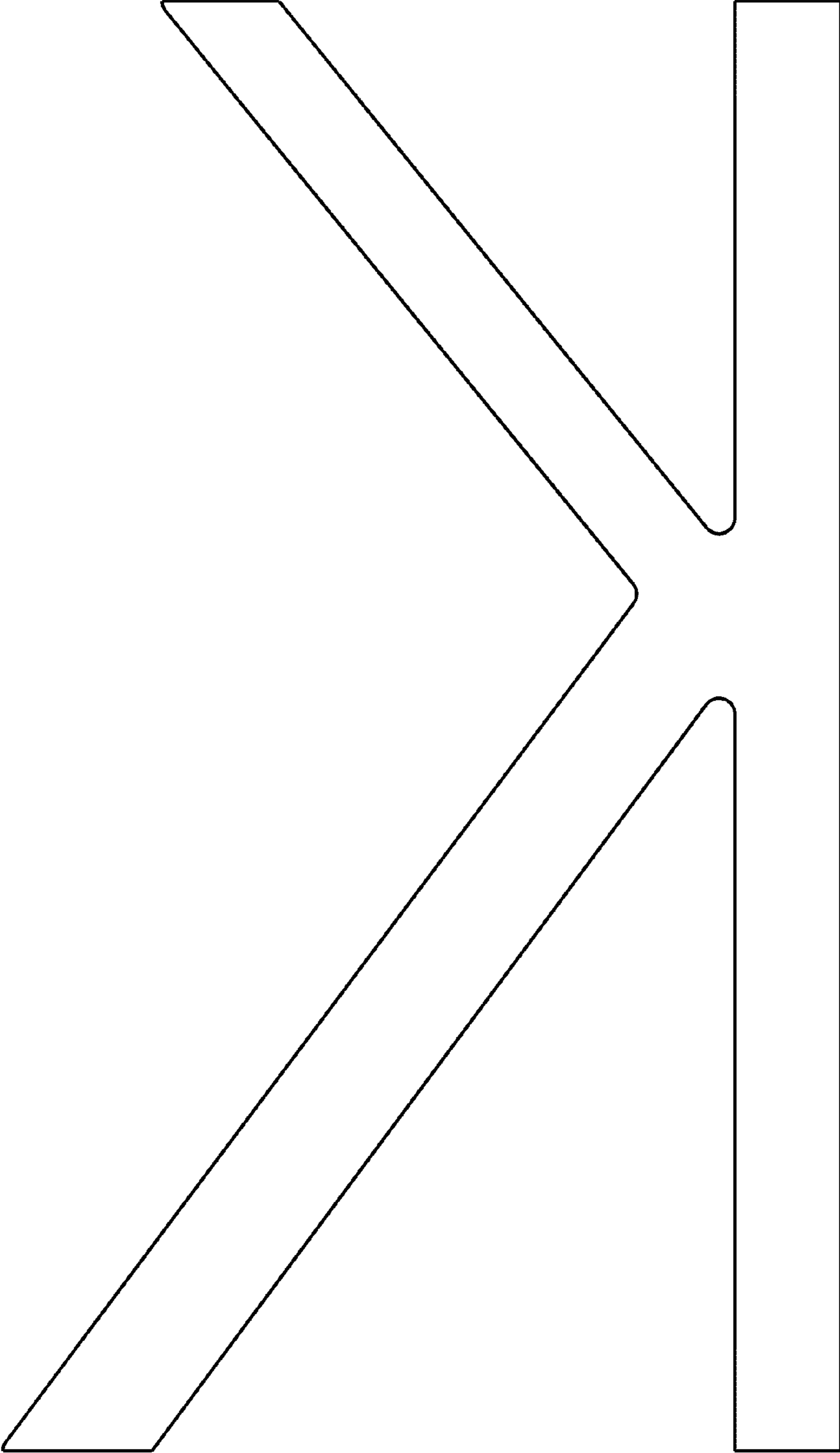

FIG. 35

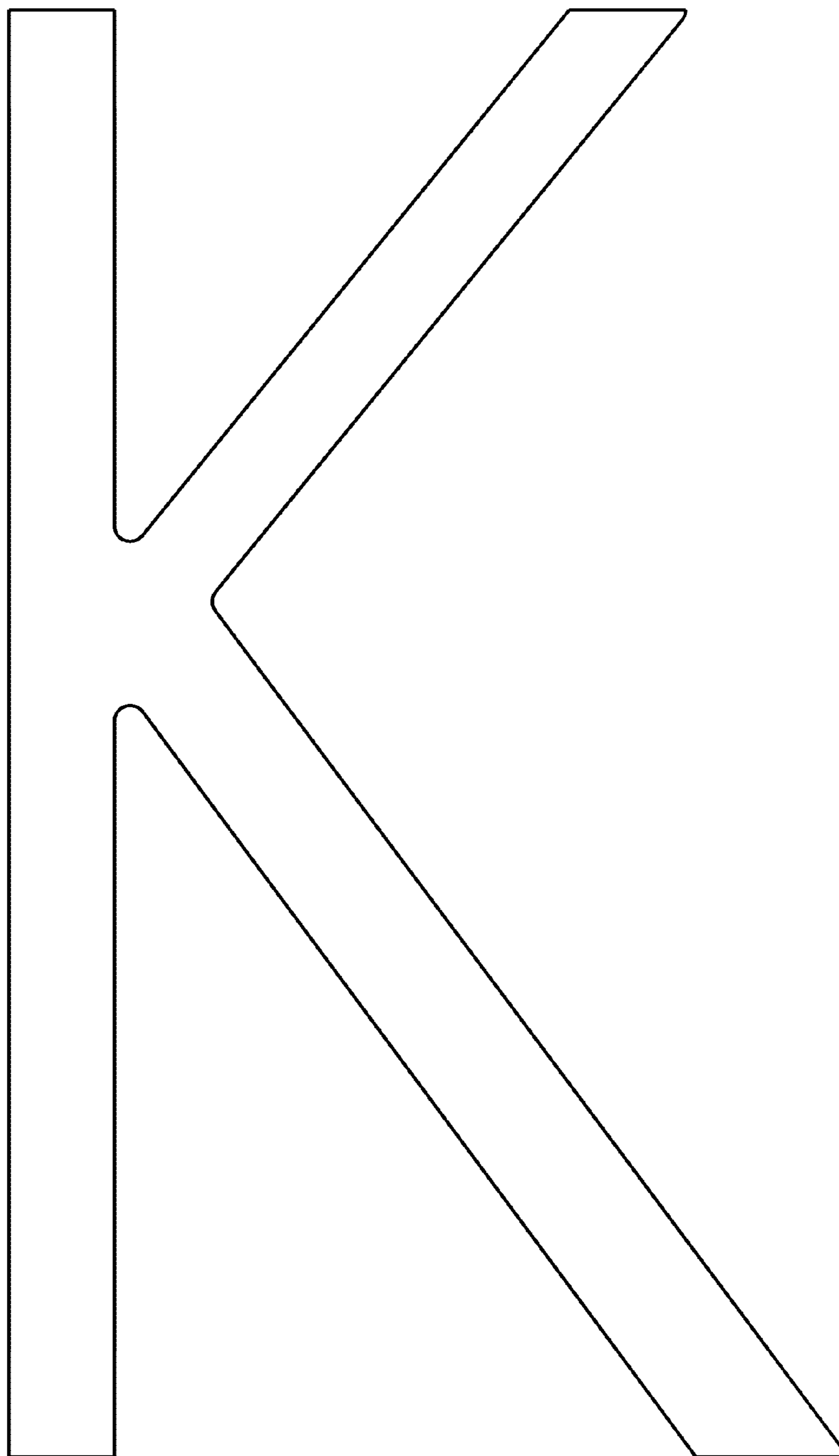

FIG. 36

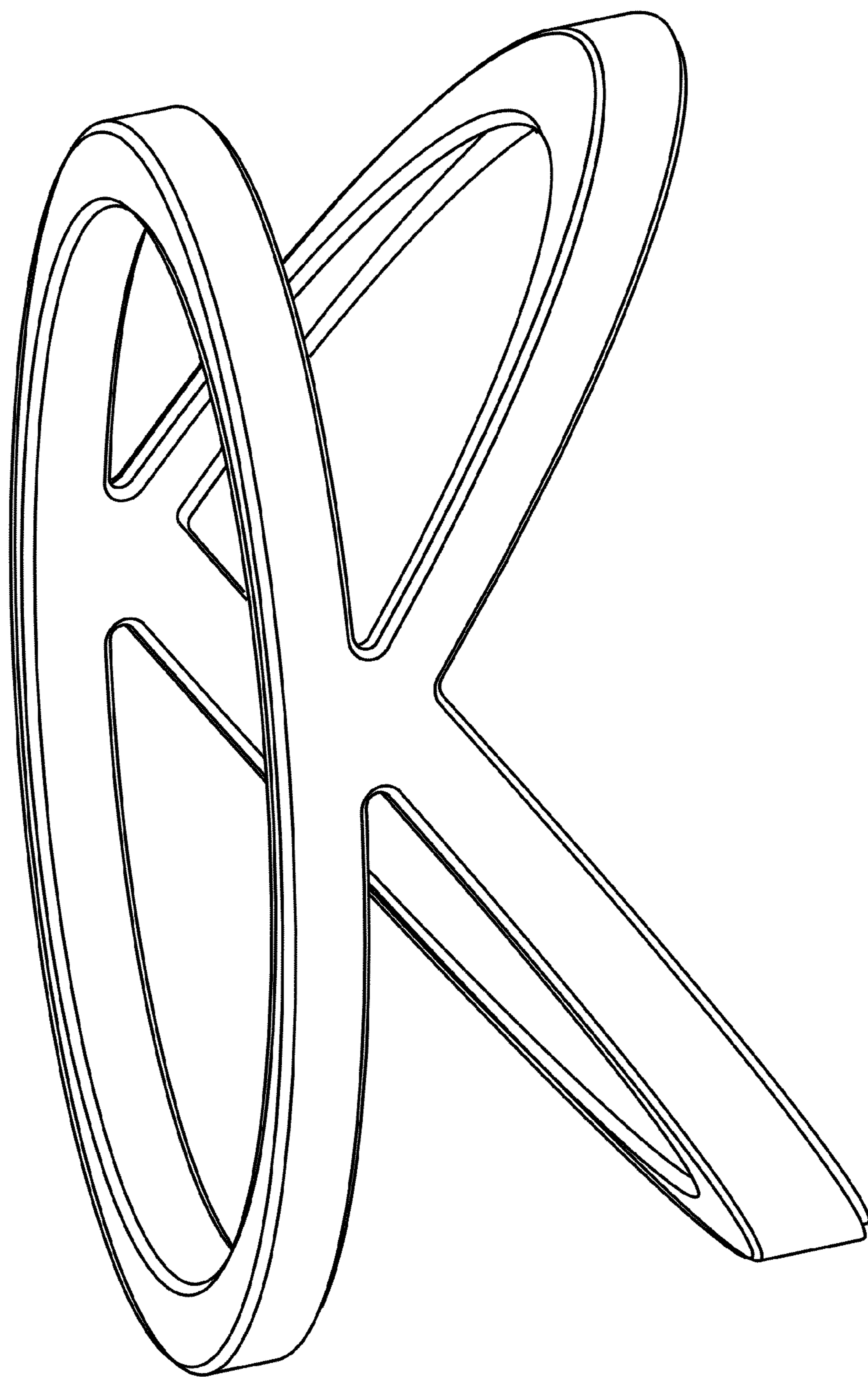

FIG. 37

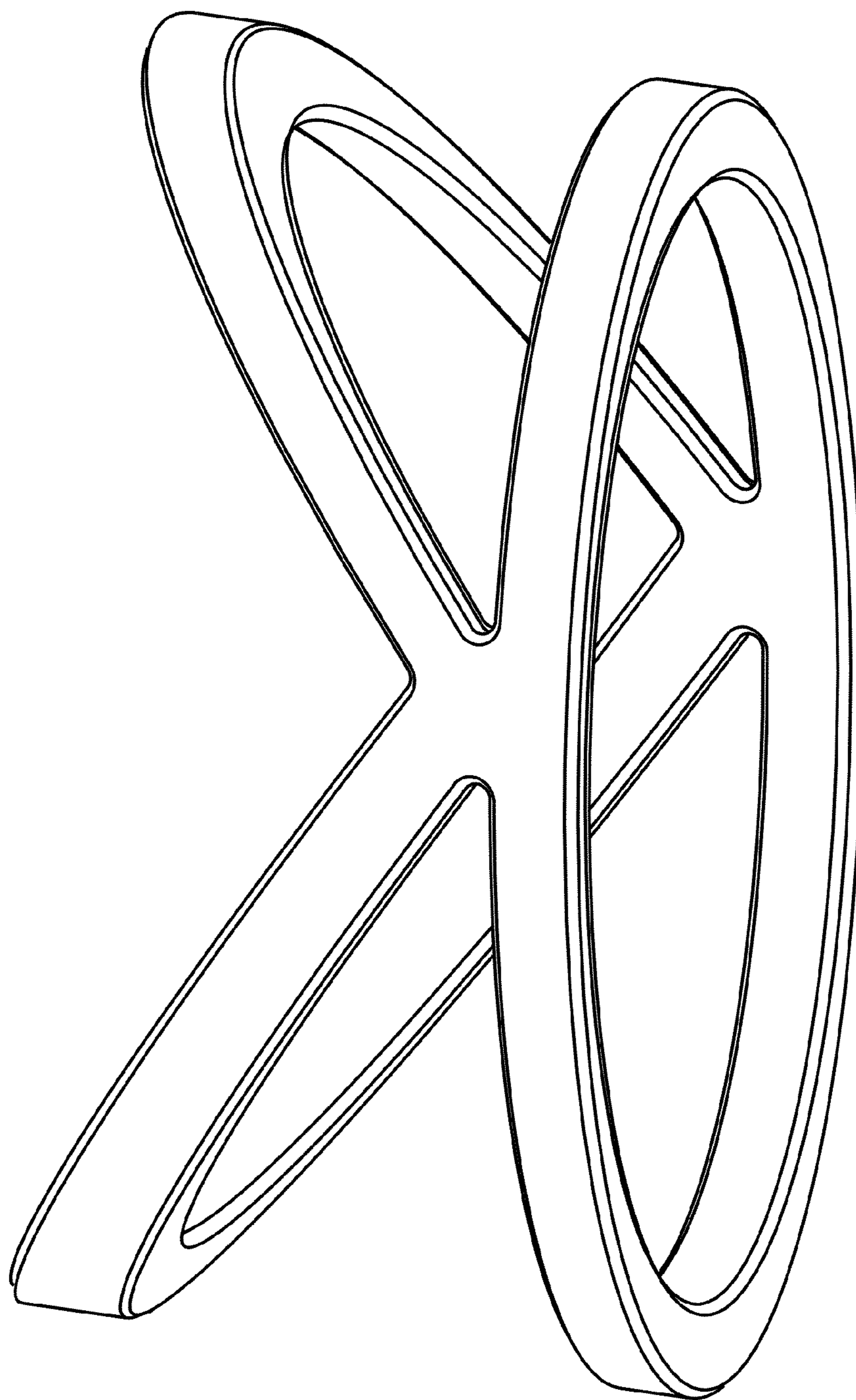

FIG. 38

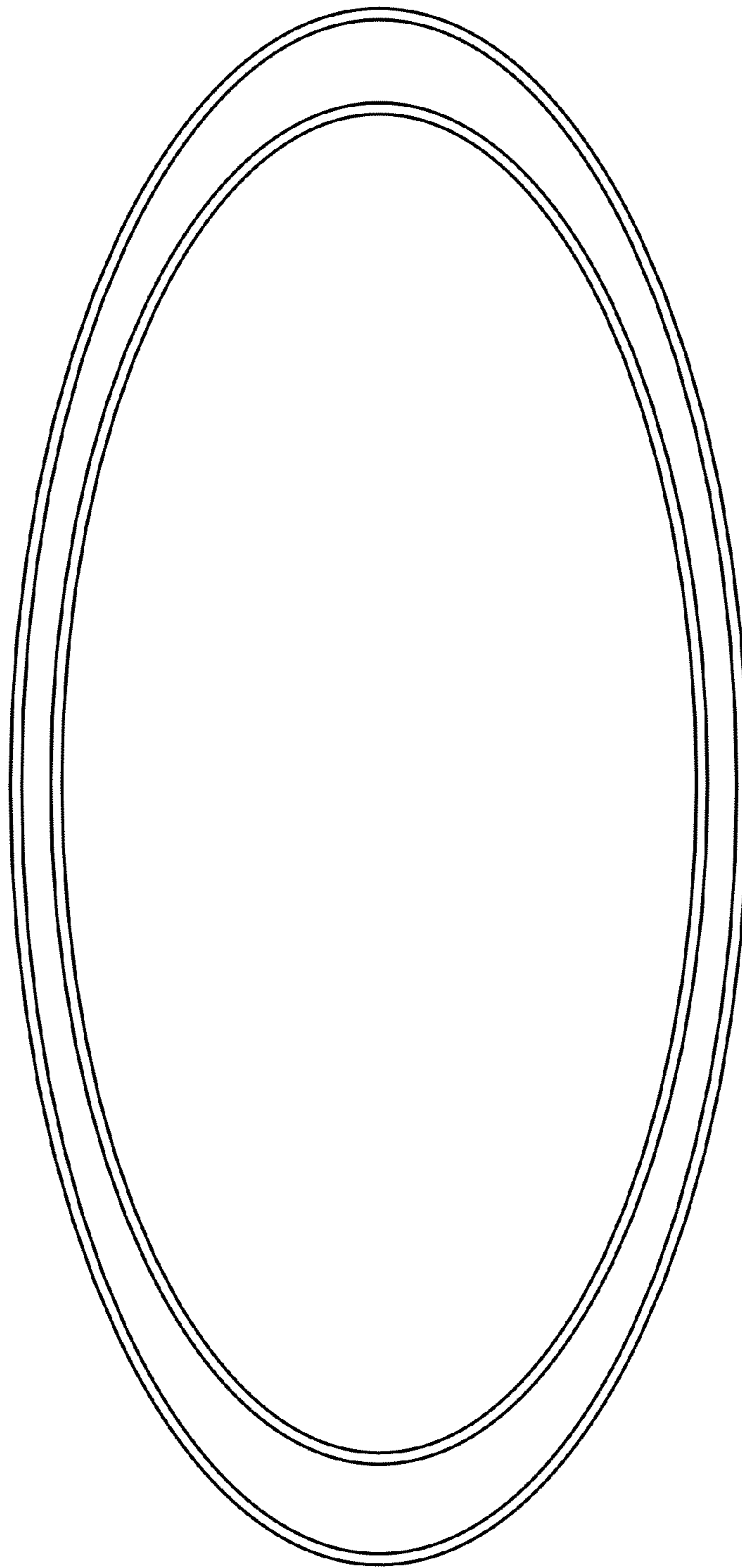

FIG. 39

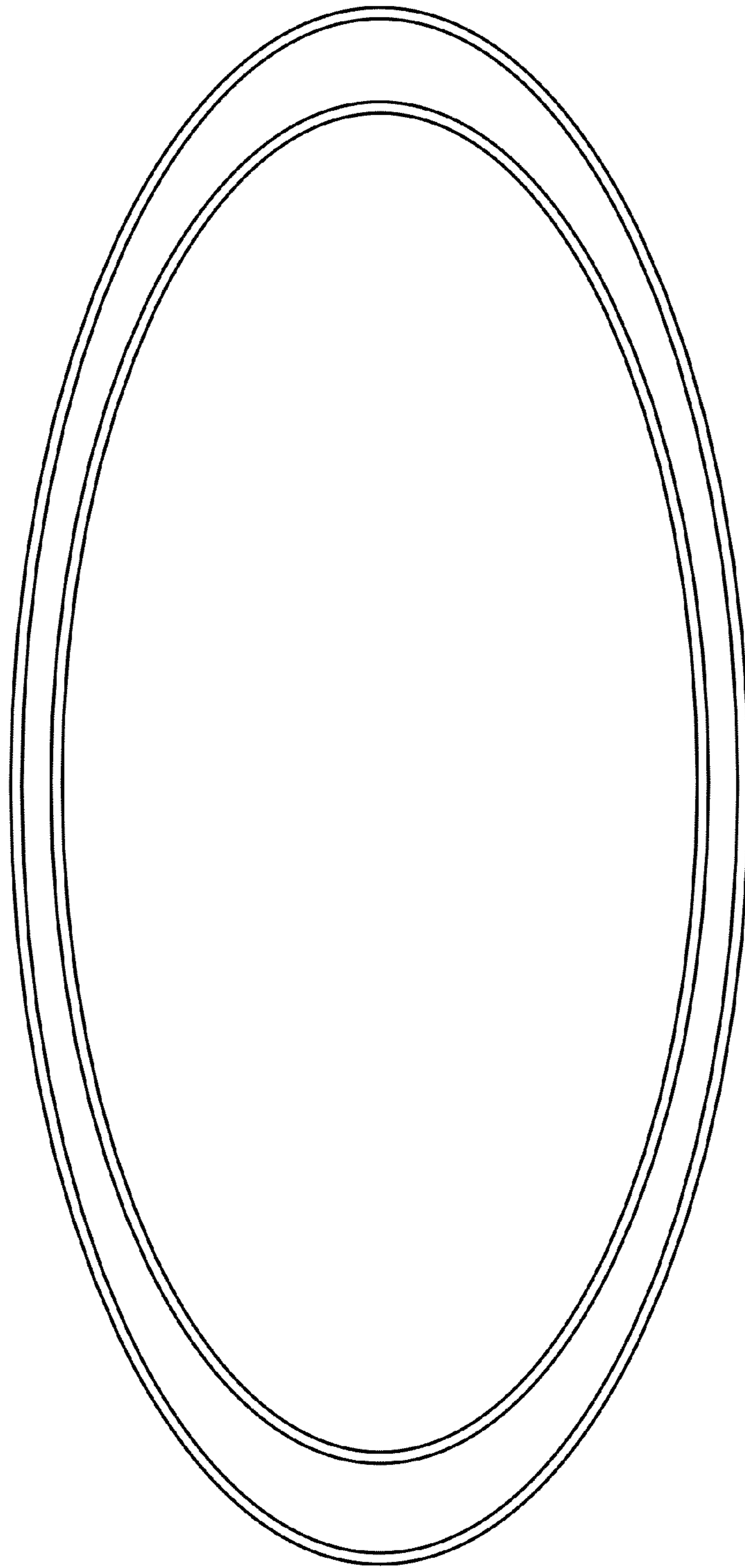

FIG. 40

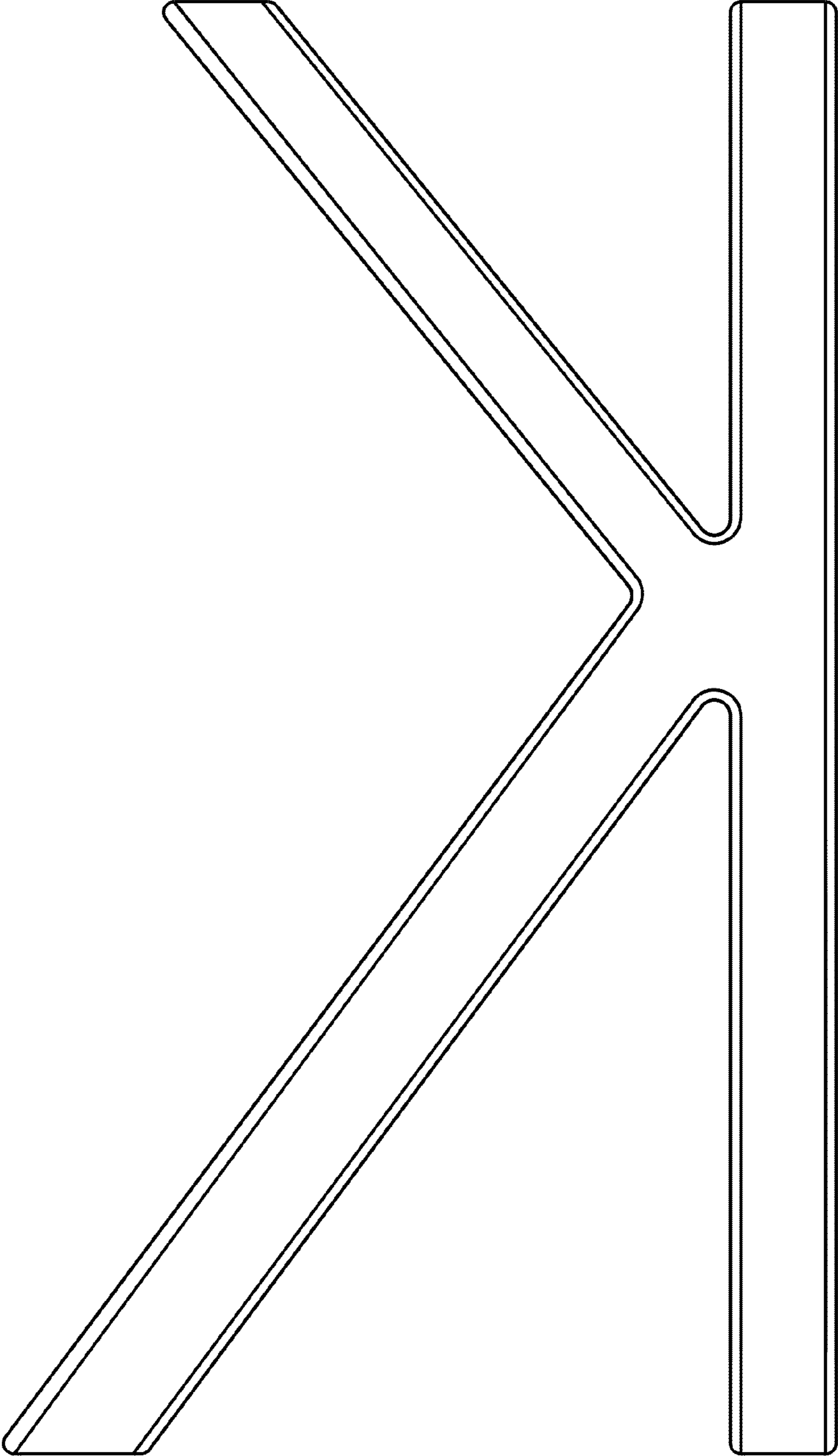

FIG. 41

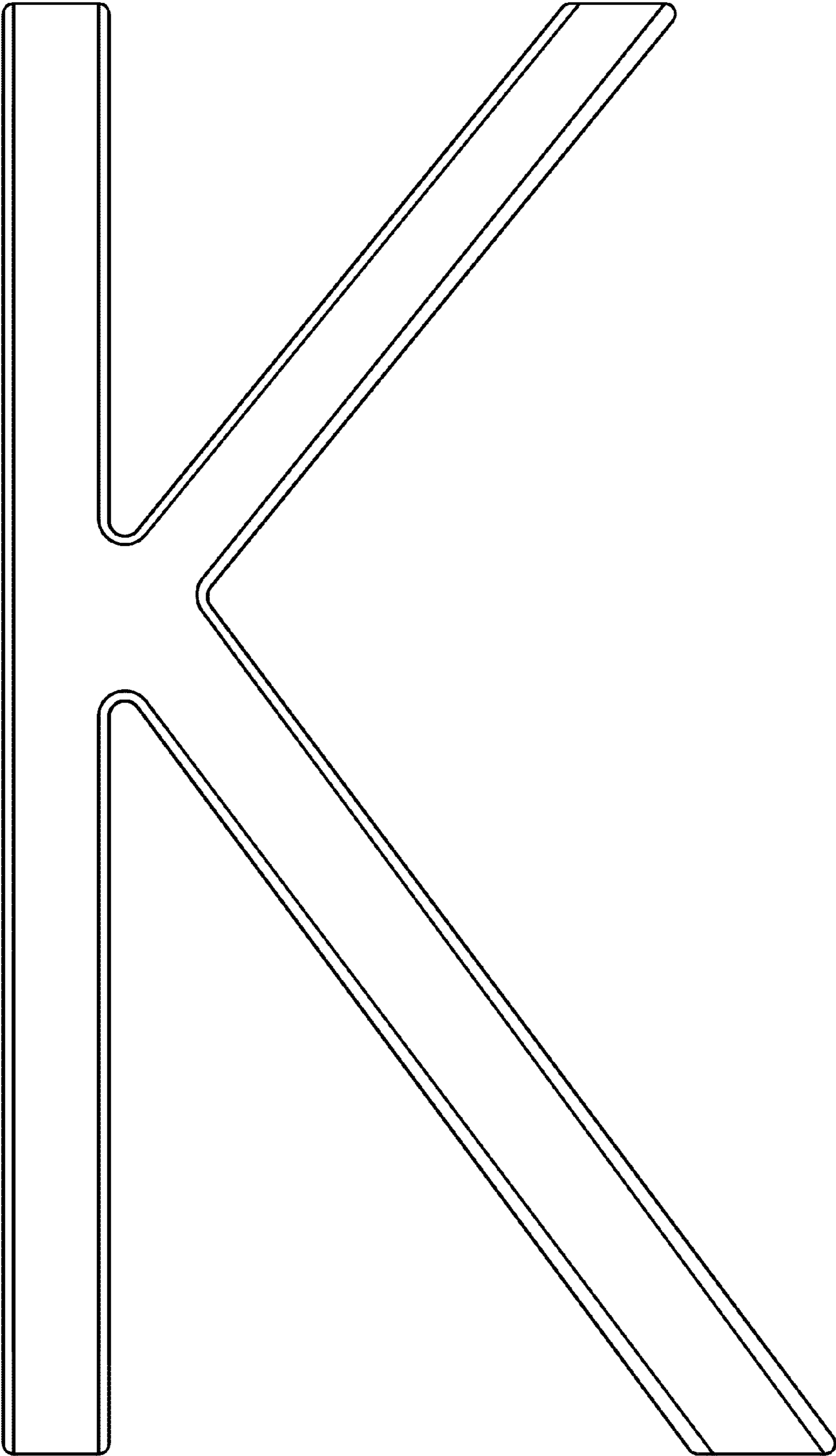

FIG. 42