



US00D746693S

(12) **United States Design Patent**
Davis

(10) **Patent No.:** **US D746,693 S**
(45) **Date of Patent:** **** Jan. 5, 2016**

(54) **BEVERAGE BOTTLE WITH POUR SPOUT**

(71) Applicant: **Kerry Davis**, Wingate, NC (US)

(72) Inventor: **Kerry Davis**, Wingate, NC (US)

(**) Term: **14 Years**

(21) Appl. No.: **29/497,885**

(22) Filed: **Jul. 29, 2014**

(51) **LOC (10) Cl.** **09-01**

(52) **U.S. Cl.**
USPC **D9/528**

(58) **Field of Classification Search**
USPC D9/414, 435, 499, 516, 523, 529, 530,
D9/542, 543, 549, 574, 571, 575, 688-691,
D9/772, 773, 776; 215/379, 381-385;
220/660, 669, 675
CPC B65D 3/00; B65D 3/04; B65D 35/22;
B65D 81/3227; B65D 81/3283
See application file for complete search history.

(56) **References Cited**

U.S. PATENT DOCUMENTS

3,127,068 A 3/1964 Sutter
D288,531 S * 3/1987 Tarasevich D9/522

D328,421 S * 8/1992 Weiler D24/115
D392,568 S * 3/1998 Goettner D9/526
D401,857 S * 12/1998 Collins D9/526
D475,626 S * 6/2003 Baruw D9/526
6,695,163 B2 2/2004 Michalowski
D495,954 S * 9/2004 Solomon D9/526
D508,651 S * 8/2005 Harrell D9/531
D510,871 S 10/2005 Nielson
D608,645 S * 1/2010 Handy D9/522
D622,149 S * 8/2010 Bernstein D9/526

* cited by examiner

Primary Examiner — Derrick Holland

Assistant Examiner — Janice Lim

(74) *Attorney, Agent, or Firm* — Crossley Patent Law

(57) **CLAIM**

The ornamental design for a beverage bottle with pour spout, as shown and described.

DESCRIPTION

FIG. 1 is a right side elevation view of a beverage bottle with pour spout, showing my new design, and the left side elevation view being a mirror image thereof; FIG. 2 is a rear elevation view thereof; FIG. 3 is a front elevation view thereof; FIG. 4 is a top plan view thereof; FIG. 5 is a bottom plan view thereof; and, FIG. 6 is an isometric view thereof.

1 Claim, 5 Drawing Sheets

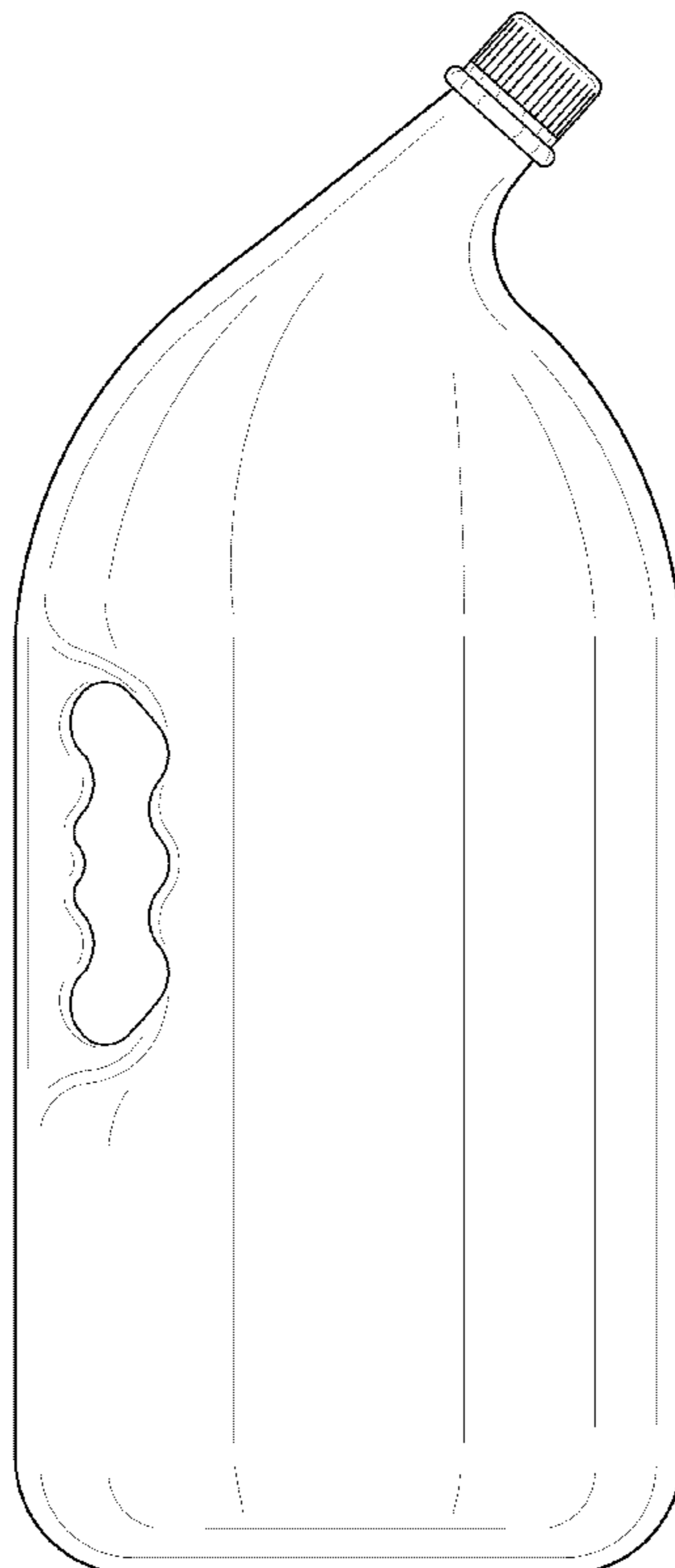

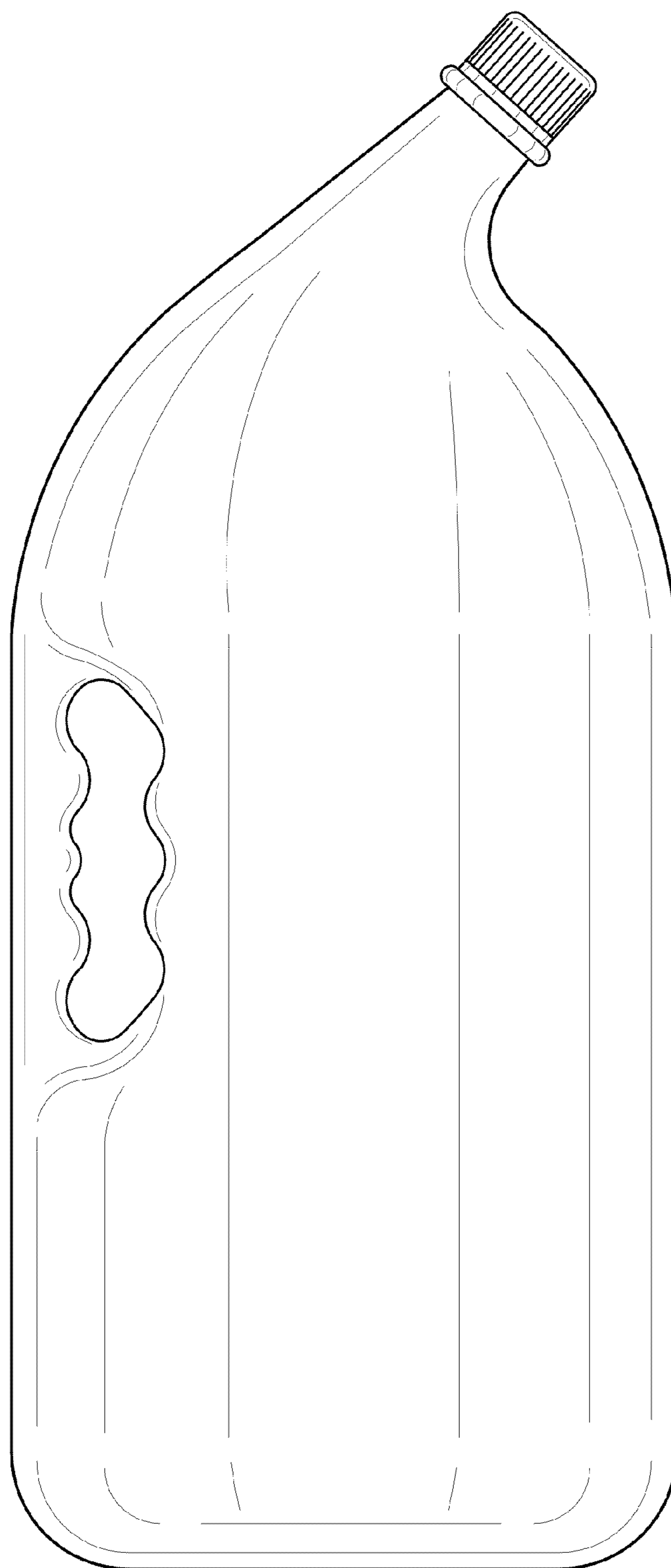

FIG. 1

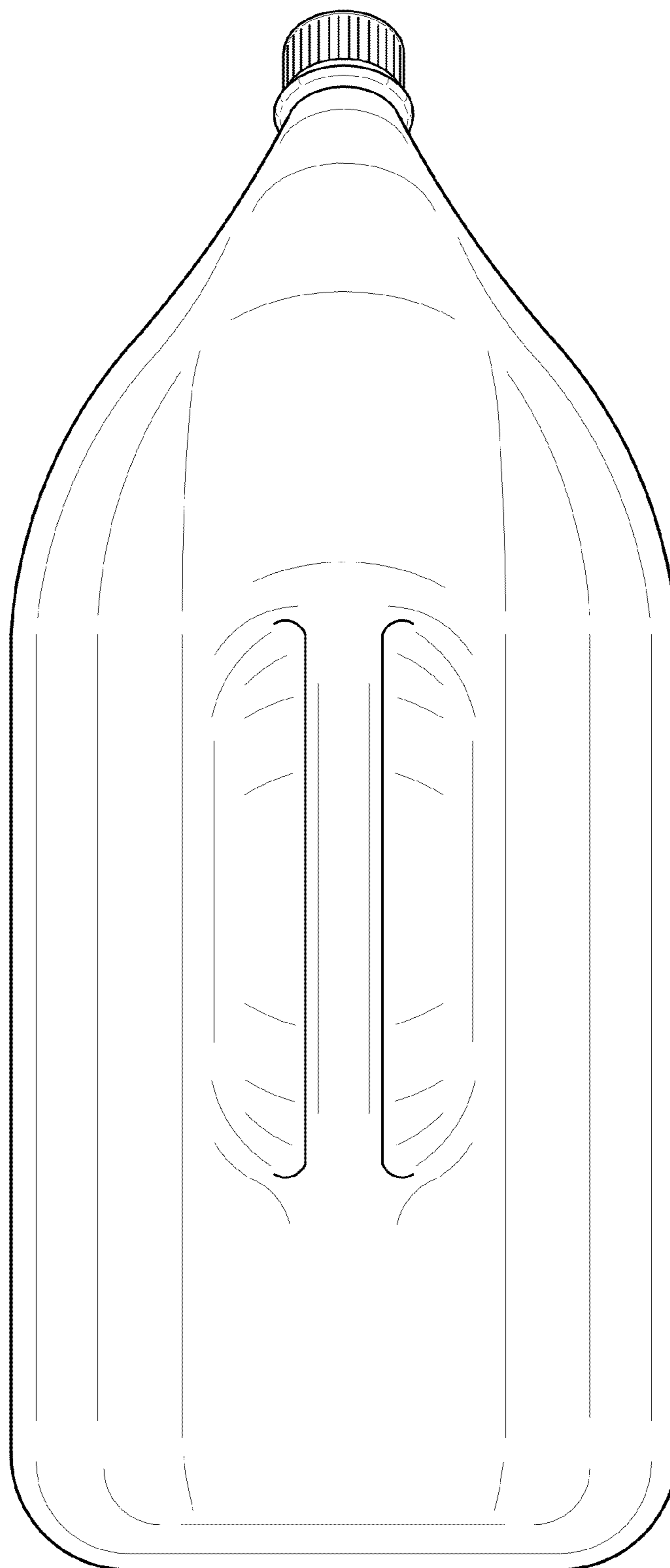

FIG. 2

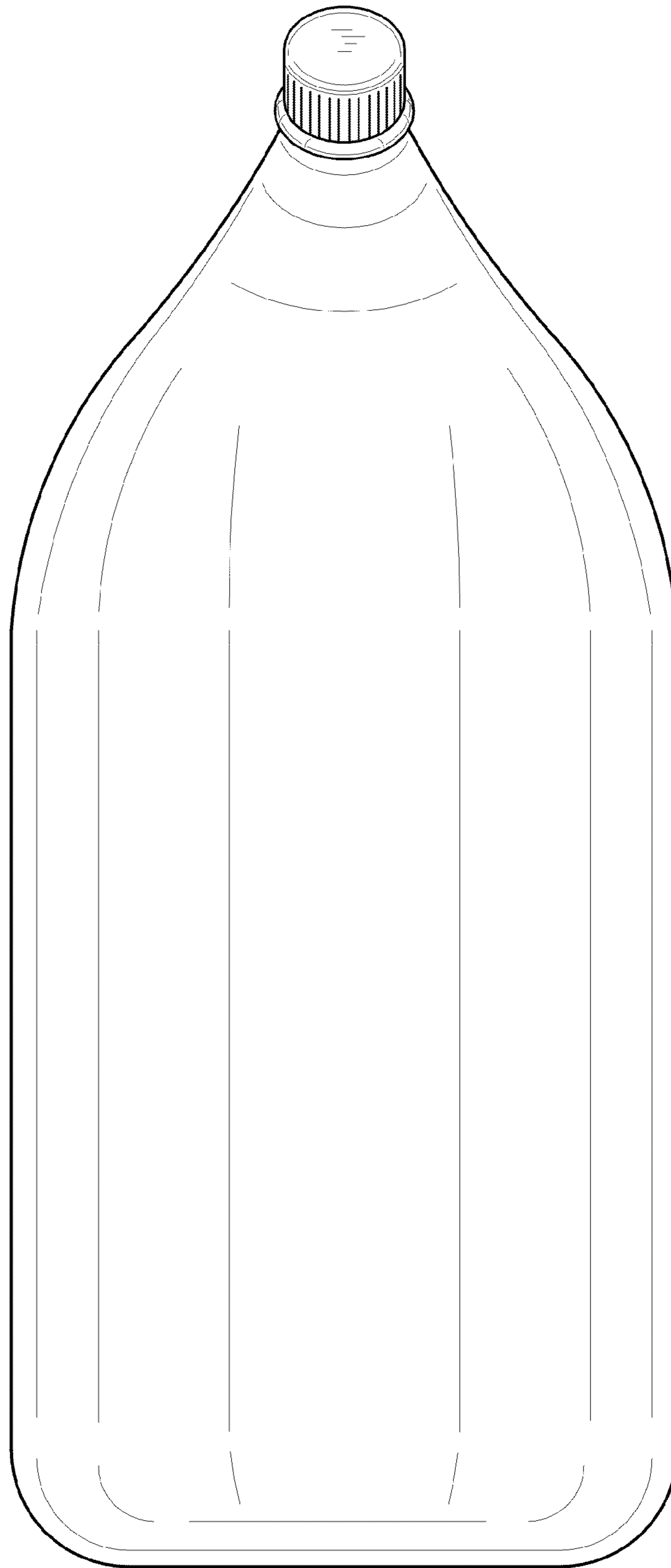

FIG. 3

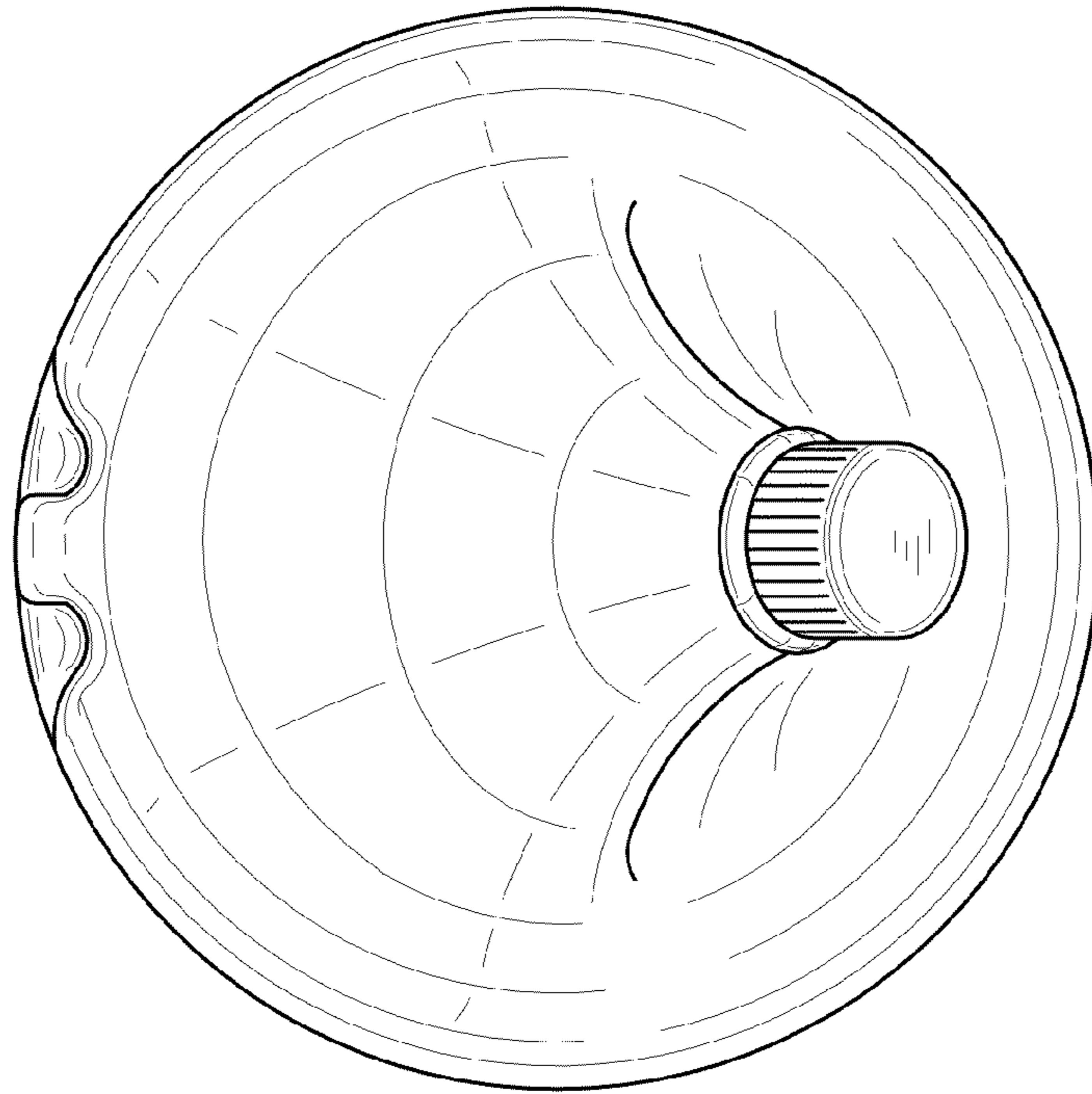

FIG. 4

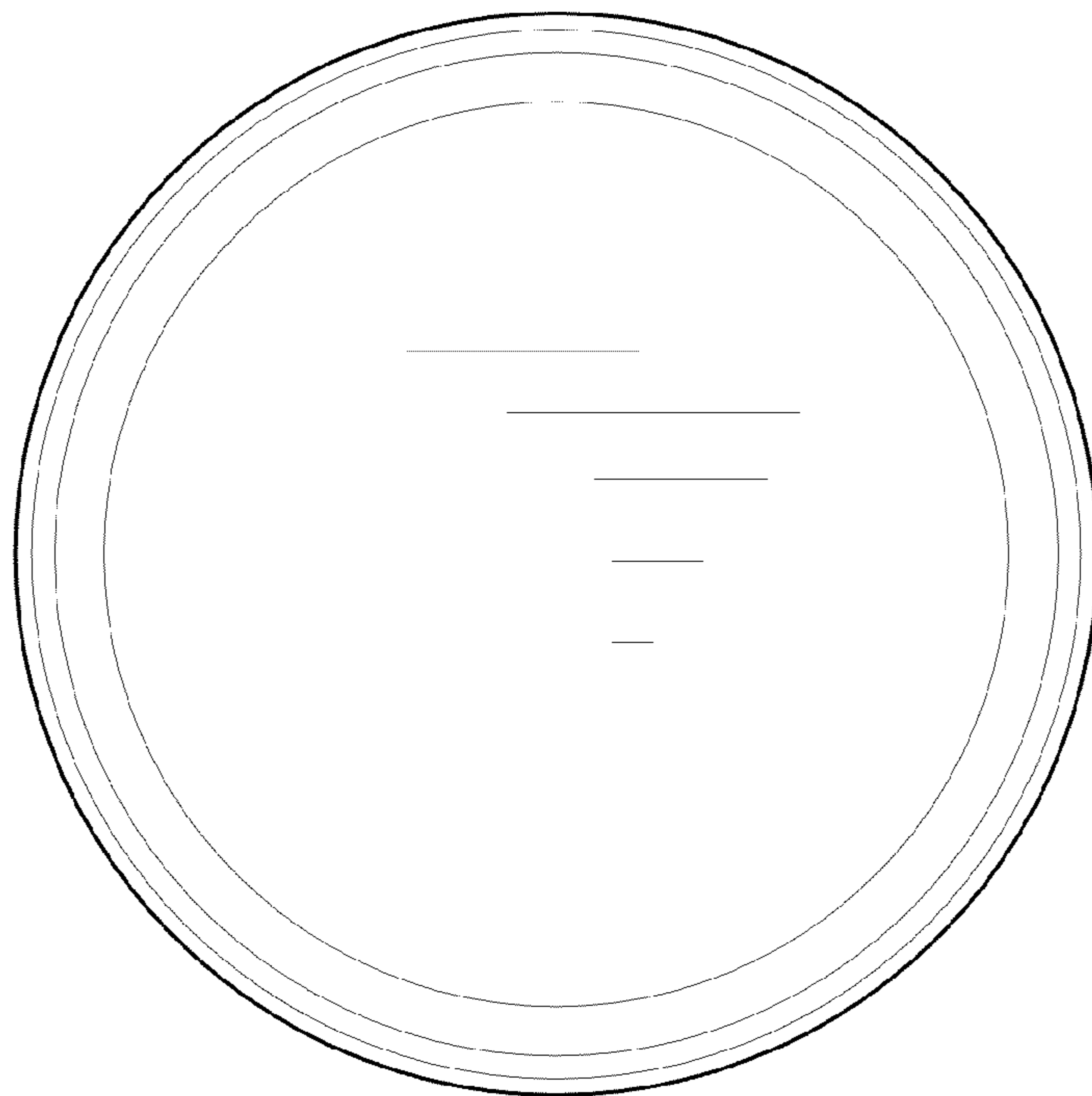

FIG. 5

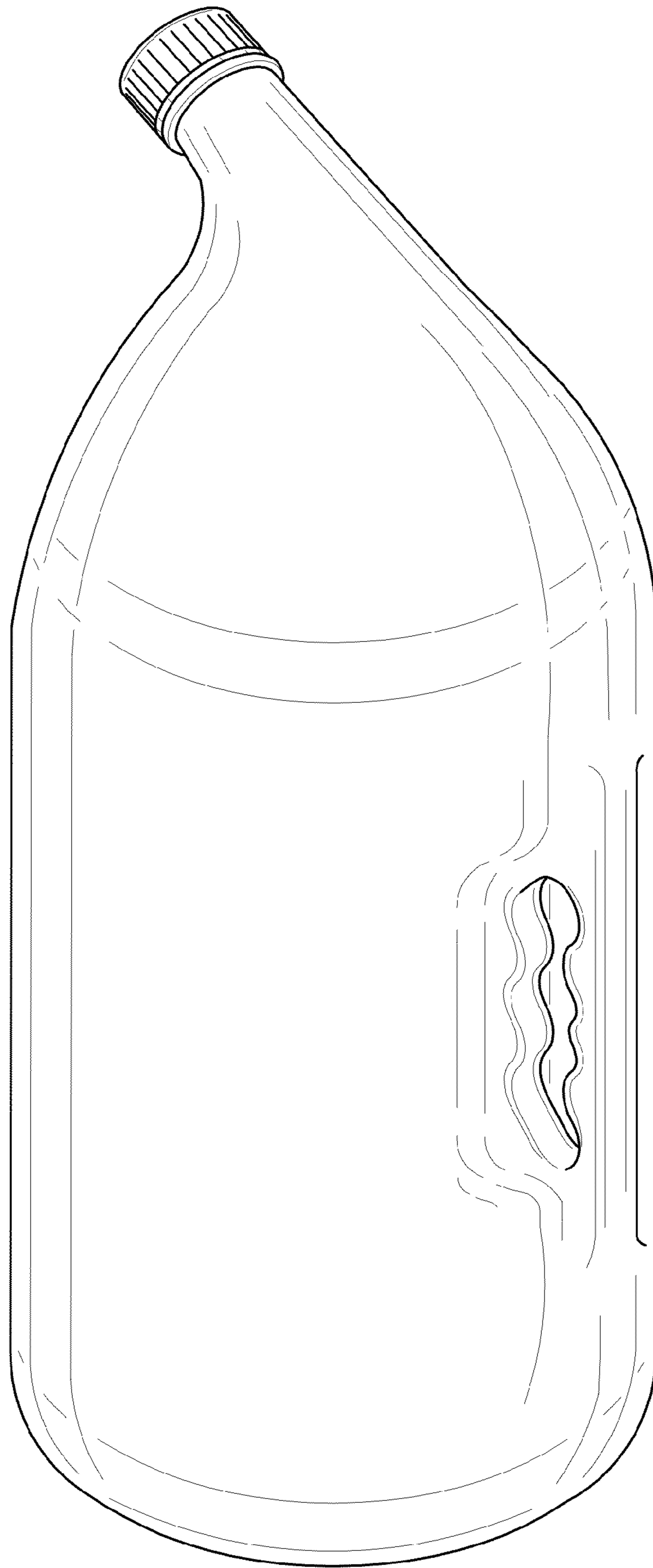

FIG. 6