



US00D746559S

(12) **United States Design Patent**
Besanceney et al.

(10) **Patent No.:** **US D746,559 S**
(45) **Date of Patent:** **** Jan. 5, 2016**

(54) **FOOTWEAR SOLE**

(71) Applicant: **Nine West Development Corporation**,
Wilmington, DE (US)

(72) Inventors: **Henry A. Besanceney**, New York, NY
(US); **John F. Ludemann**, Southport,
ME (US)

(73) Assignee: **Nine West Development LLC**, New
York, NY (US)

(**) Term: **14 Years**

(21) Appl. No.: **29/465,232**

(22) Filed: **Aug. 26, 2013**

Related U.S. Application Data

(63) Continuation-in-part of application No. 29/382,988,
filed on Jan. 10, 2011, now abandoned.

(51) **LOC (10) Cl.** **02-04**

(52) **U.S. Cl.**
USPC **D2/947**; D2/954; D2/956

(58) **Field of Classification Search**
USPC D2/902, 906, 908, 916, 918, 925,
D2/946-962, 977; 36/3 B, 22 R, 24.5, 25 R,
36/28, 32 R, 34 R, 59 C, 67 A, 103
CPC A43B 13/00; A43B 13/02; A43B 13/023;
A43B 13/026; A43B 13/04; A43B 13/08;
A43B 13/10; A43B 13/12; A43B 13/14;
A43B 13/141; A43B 13/143; A43B 13/16;
A43B 13/18; A43B 13/181; A43B 13/187;
A43B 13/189; A43B 13/20; A43B 13/22;
A43B 13/223; A43B 13/24; A43B 13/28;
A43B 13/30; A43B 13/32; A43B 13/34;
A43B 13/36

See application file for complete search history.

(56) **References Cited**

U.S. PATENT DOCUMENTS

D331,313	S	*	12/1992	Lesbirel	D2/954
D332,692	S	*	1/1993	Hatfield et al.	D2/953
5,371,957	A	*	12/1994	Gaudio	36/50.1
5,588,226	A		12/1996	Schenkel		
5,983,524	A		11/1999	Polegato		
5,992,052	A		11/1999	Moretti		

(Continued)

Primary Examiner — T. Chase Nelson

(74) *Attorney, Agent, or Firm* — Senniger Powers LLP

(57) **CLAIM**

The ornamental design for a footwear sole, as shown and described.

DESCRIPTION

FIG. 1 is a right side elevation of a first embodiment of a footwear sole;

FIG. 2 is a left side elevation of the first embodiment;

FIG. 3 is a bottom plan thereof;

FIG. 4 is a cross section taken in the plane of line 4-4 of FIG. 1, the cross section being typical of every similarly sized element shown in each of the side elevations of both embodiments;

FIG. 5 is a cross section taken in the plane of line 5-5 of FIG. 1, the cross section being typical of every similarly sized element shown in each of the side elevations of both embodiments;

FIG. 6 is a cross section taken in the plane of line 6-6 of FIG. 1, the side profiles thereof being typical of both embodiments;

FIG. 7 is a right side elevation of a second embodiment of a footwear sole;

FIG. 8 is a left side elevation of the second embodiment; and, FIG. 9 is a bottom plan thereof.

The elements shown in dashed lines depict portions of the footwear sole forming no part of the claimed design. The top plans of the sole form no part of the claimed design.

1 Claim, 7 Drawing Sheets

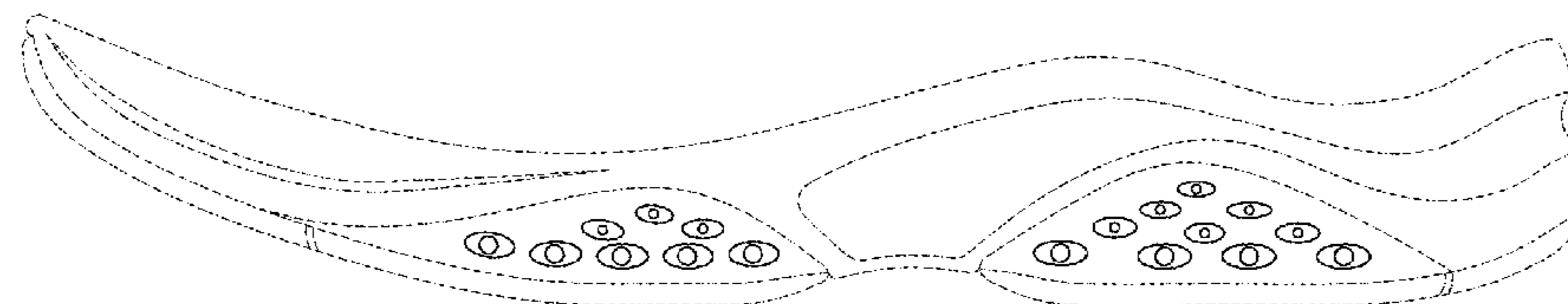
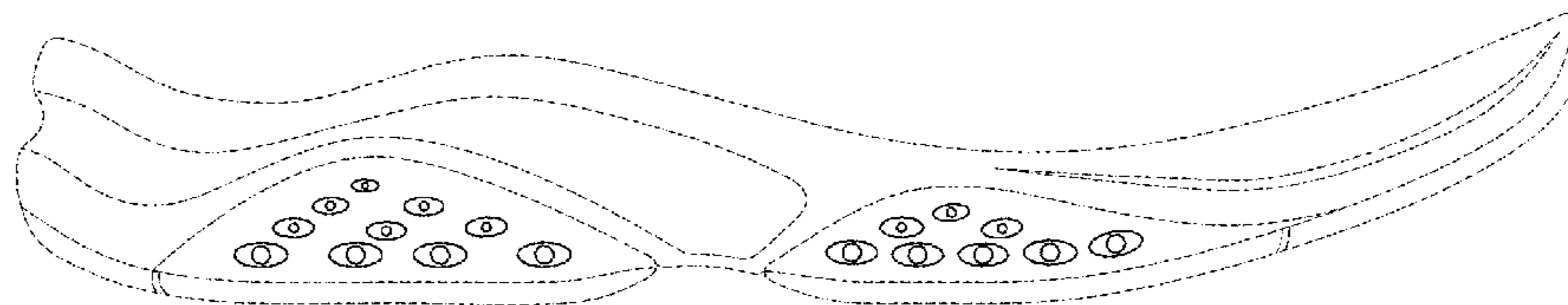

(56)

References Cited

U.S. PATENT DOCUMENTS

6,038,790	A *	3/2000	Pyle et al.	36/30 R	7,823,297	B2	11/2010	Polegato Moretti	
D422,780	S *	4/2000	Aguerre	D2/916	D636,570	S *	4/2011	Merritt et al.	D2/951
6,092,305	A	7/2000	Troy et al.		D637,803	S *	5/2011	Alvear et al.	D2/954
D429,552	S *	8/2000	Kern	D2/953	D642,775	S *	8/2011	Raysse	D2/946
6,282,813	B1	9/2001	Squadroni		D645,240	S *	9/2011	McClaskie	D2/959
6,389,711	B1	5/2002	Polegato		D650,566	S *	12/2011	Yamashita et al.	D2/951
6,408,541	B1	6/2002	Moretti		D650,567	S *	12/2011	Badegruber	D2/956
6,604,302	B2	8/2003	Polegato Moretti		D657,945	S *	4/2012	Oberschneider	D2/953
6,655,048	B2	12/2003	Moretti		D659,963	S *	5/2012	Merritt et al.	D2/951
6,681,500	B2	1/2004	Moretti		D664,754	S *	8/2012	Klein et al.	D2/961
6,823,609	B2	11/2004	Moretti		D665,566	S *	8/2012	Klein et al.	D2/961
6,839,984	B2	1/2005	Polegato		D668,854	S *	10/2012	Dean et al.	D2/947
6,874,251	B2	4/2005	Moretti		D669,673	S *	10/2012	Alush	D2/957
6,904,705	B2	6/2005	Polegato Moretti		8,424,223	B2 *	4/2013	Jara et al.	36/59 R
D507,863	S *	8/2005	McClaskie	D2/952	8,789,298	B2 *	7/2014	Eder et al.	36/133
D511,608	S *	11/2005	Carnes	D2/908	8,793,902	B2 *	8/2014	Besanceney et al.	36/3 B
D513,111	S *	12/2005	Caine	D2/908	D722,425	S *	2/2015	Cin	D2/947
7,017,284	B2	3/2006	Keidel et al.		2005/0000117	A1	1/2005	Polegato Moretti	
7,096,604	B2	8/2006	Polegato Moretti		2005/0241082	A1	11/2005	Moretti	
D544,183	S *	6/2007	Hull	D2/955	2008/0216358	A1	9/2008	Polegato Moretti	
D545,035	S *	6/2007	Roulo	D2/959	2009/0188134	A1	7/2009	Polegato Moretti	
D545,036	S *	6/2007	Roulo	D2/959	2009/0193690	A1	8/2009	Moretti	
D552,337	S *	10/2007	Parekh et al.	D2/959	2009/0199438	A1	8/2009	Polegato Moretti	
7,367,141	B2	5/2008	Polegato Moretti		2009/0211119	A1	8/2009	Moretti	
7,370,382	B2	5/2008	Polegato Moretti		2009/0277047	A1	11/2009	Polegato Moretti	
D590,586	S *	4/2009	Harlow	D2/960	2010/0011624	A1	1/2010	Polegato Moretti	
D593,290	S *	6/2009	Chen	D2/953	2010/0050480	A1	3/2010	Polegato Moretti	
7,546,697	B2	6/2009	Polegato Moretti		2010/0132228	A1	6/2010	Polegato Moretti	
7,559,157	B2	7/2009	Polegato Moretti		2011/0113646	A1 *	5/2011	Merritt et al.	36/28
D608,999	S *	2/2010	McClaskie	D2/959	2011/0113649	A1 *	5/2011	Merritt et al.	36/102
7,716,851	B2	5/2010	Polegato Moretti		2011/0185593	A1 *	8/2011	Ramos	36/103
7,793,426	B2	9/2010	Byrne et al.		2012/0005920	A1 *	1/2012	Alvear et al.	36/28
					2012/0047770	A1 *	3/2012	Dean et al.	36/103
					2012/0174444	A1 *	7/2012	Besanceney et al.	36/30 R

* cited by examiner

FIG. 1

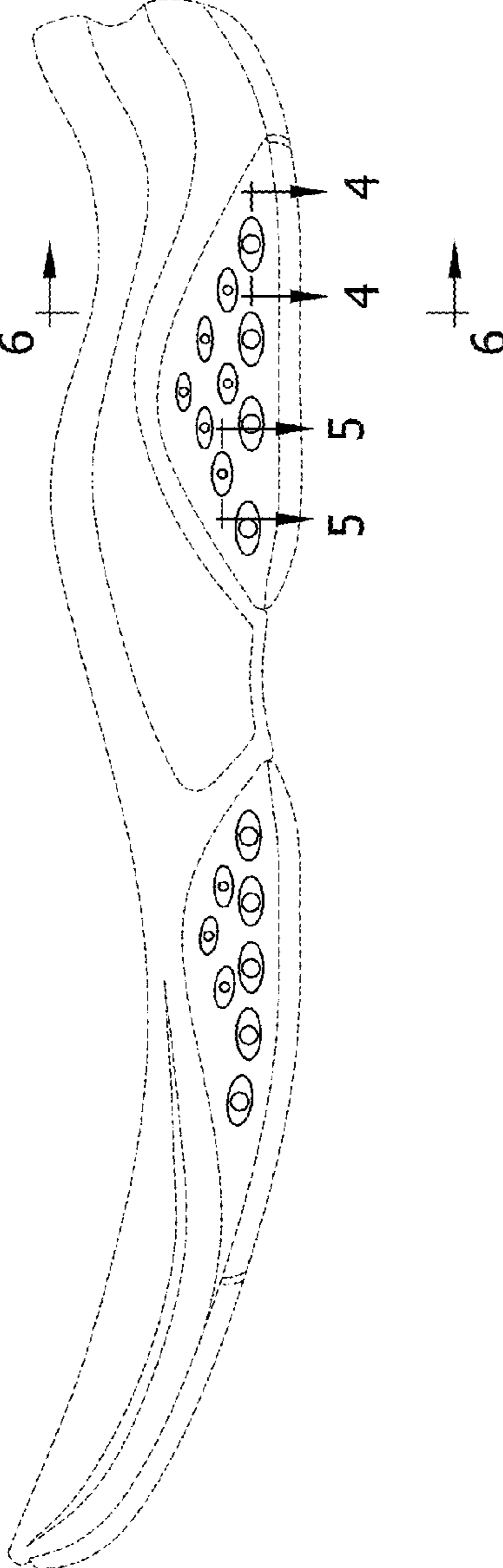

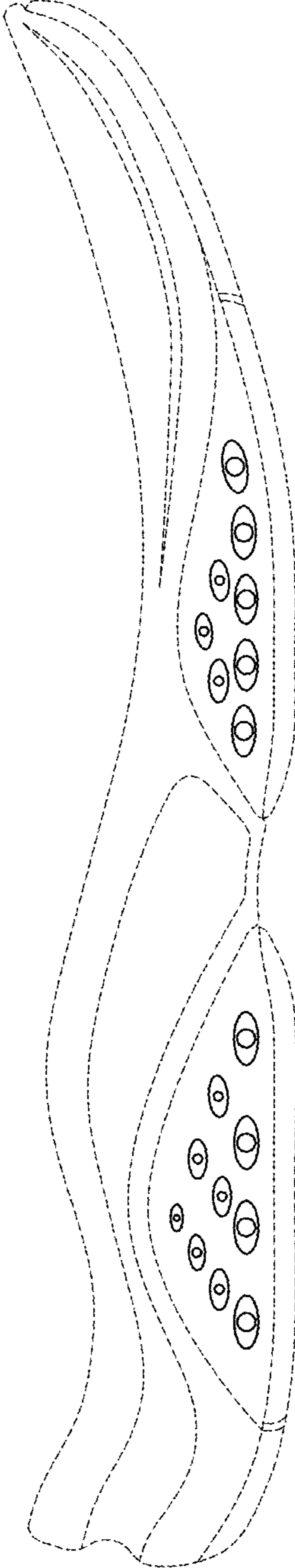

FIG. 2

FIG. 3

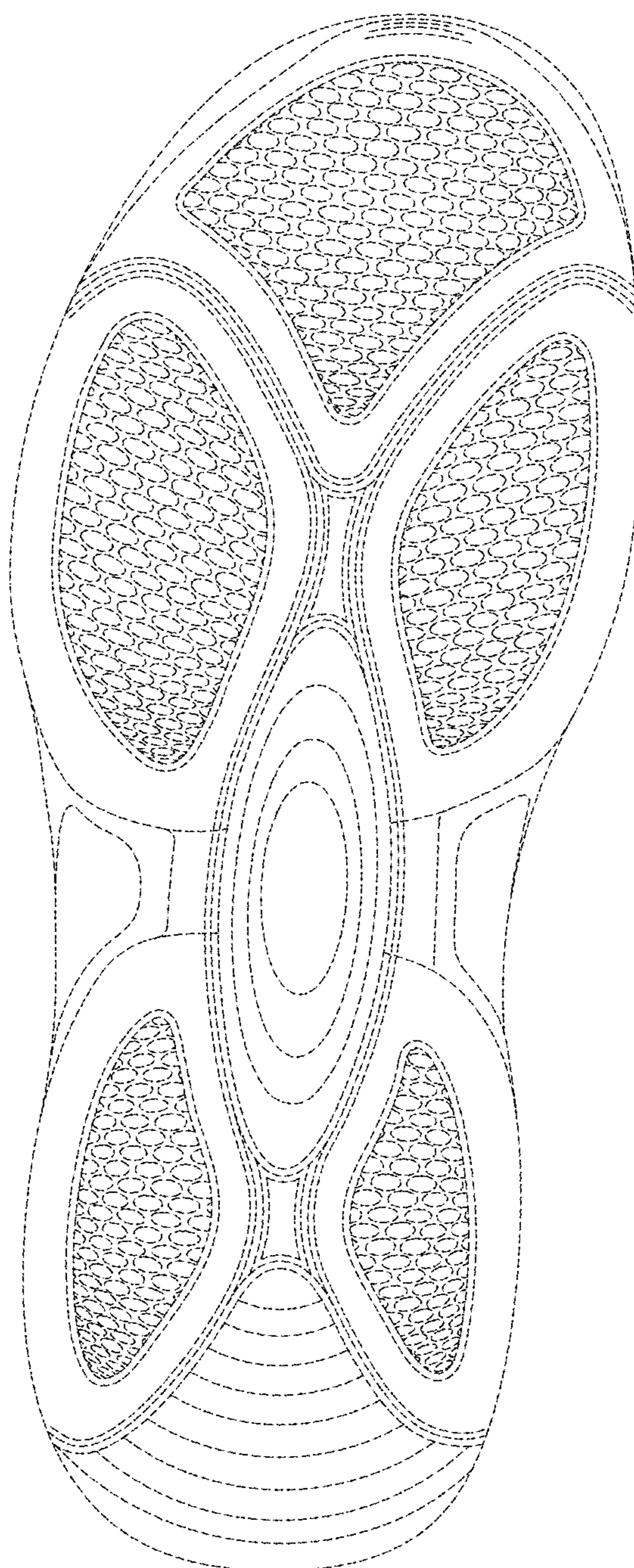

FIG. 4

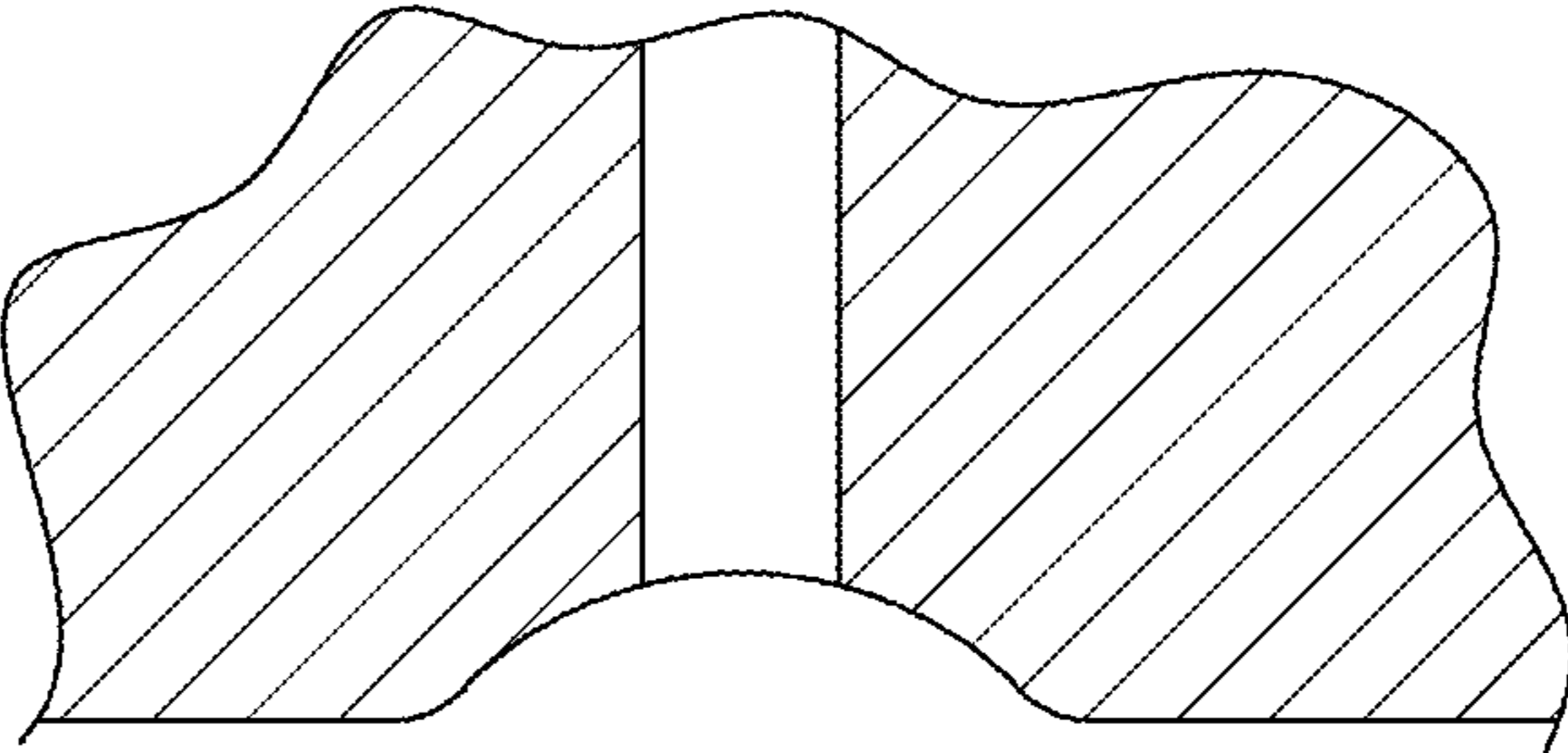

FIG. 5

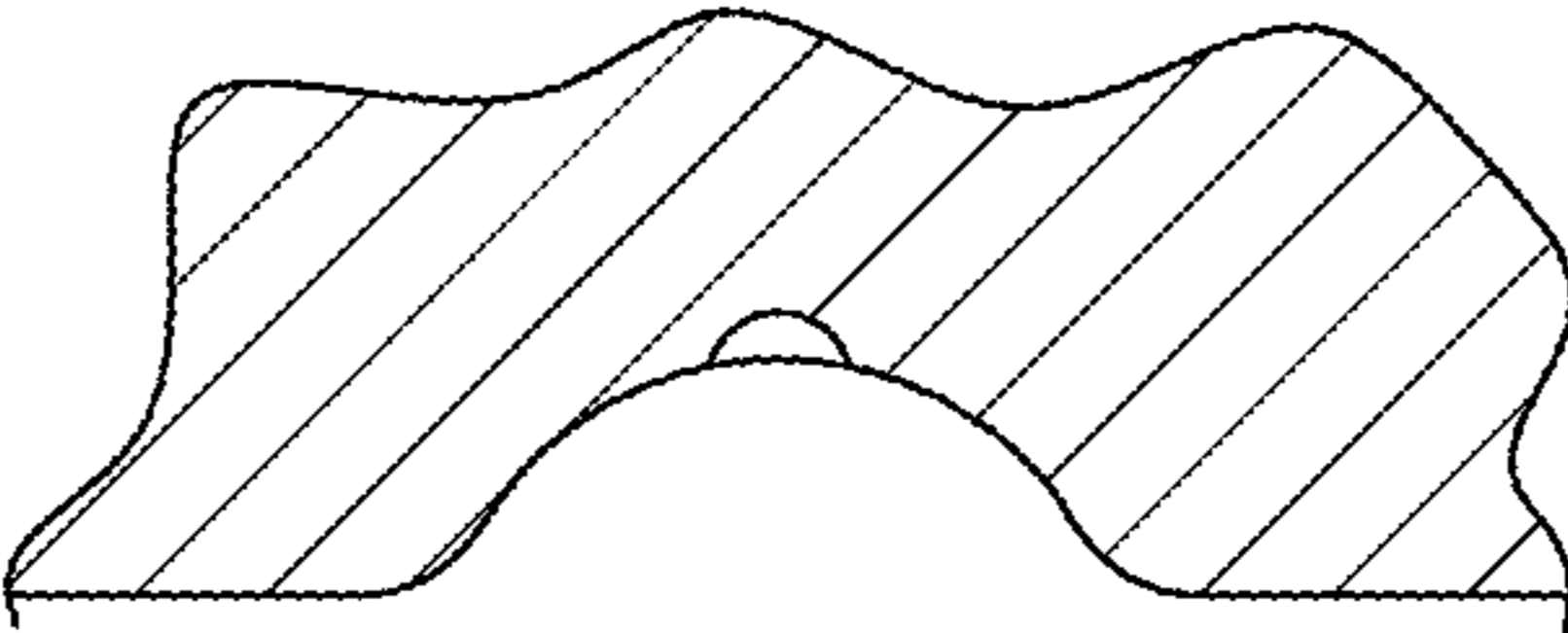
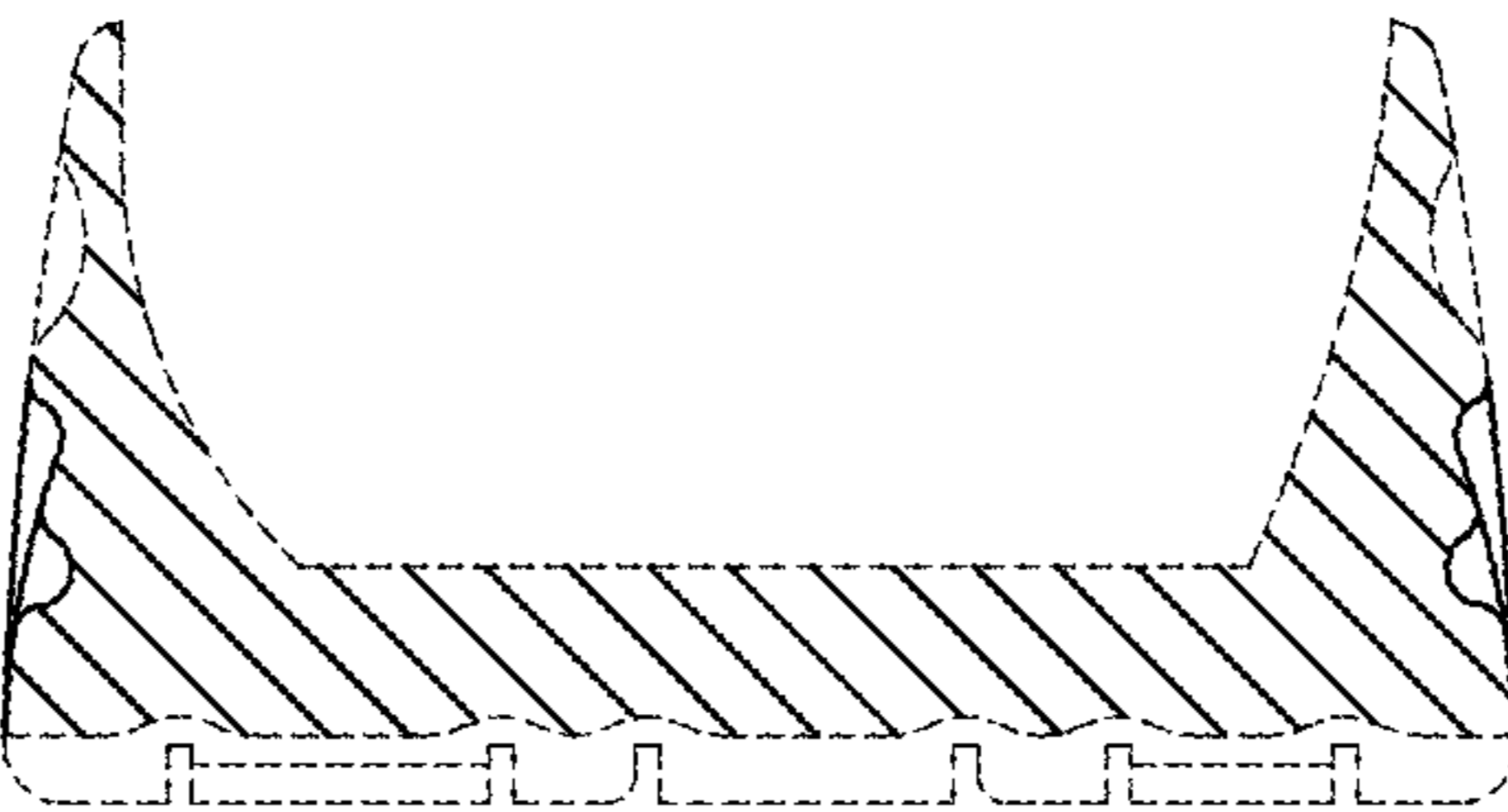

FIG. 6



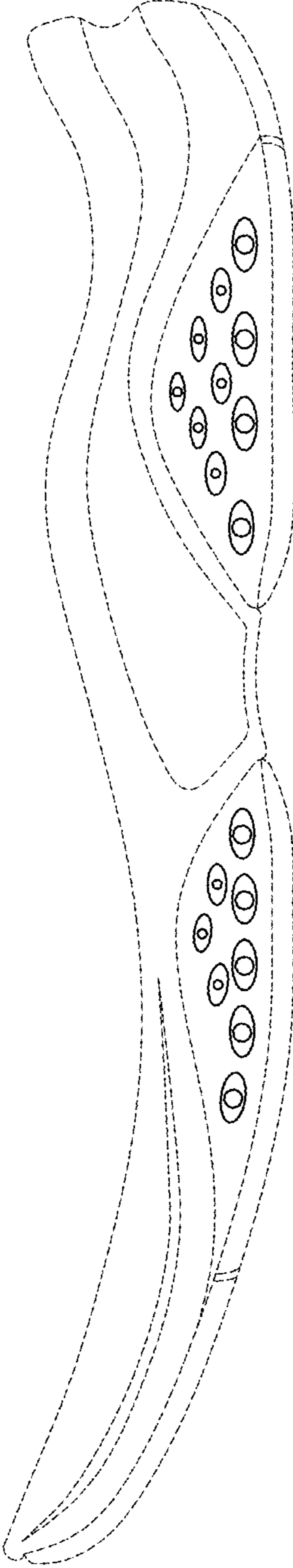

FIG. 7

FIG. 8

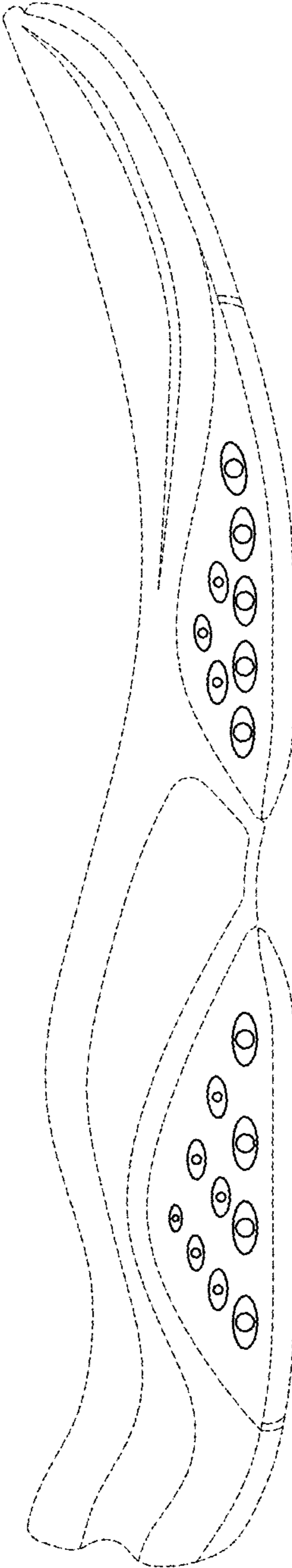

FIG. 9

