



US00D746538S

(12) **United States Design Patent**
Cha et al.

(10) **Patent No.:** **US D746,538 S**

(45) **Date of Patent:** **** Dec. 29, 2015**

(54) **AUTOMATED TELLER MACHINE**

(56) **References Cited**

(71) Applicant: **Nautilus Hyosung Inc.**, Seoul (KR)

U.S. PATENT DOCUMENTS

(72) Inventors: **Jae Min Cha**, Sungnam-si (KR); **Joon Hee Kim**, Seoul (KR); **Jae Min Park**, Anyang-si (KR); **Hee Youn Lee**, Sungnam-si (KR)

D332,165 S *	12/1992	Fukutake et al.	D99/28
D360,735 S *	7/1995	Hall	D99/28
D405,833 S *	2/1999	Mussett	D20/1
D410,129 S *	5/1999	Molander et al.	D99/28
D427,413 S *	6/2000	Wallace et al.	D99/35
D479,642 S *	9/2003	Magee et al.	D99/28
D492,080 S *	6/2004	Magee et al.	D99/28
D494,730 S *	8/2004	Magee et al.	D99/28
D505,765 S *	5/2005	Swaine et al.	D99/28

(73) Assignee: **NAUTILUS HYOSUNG INC.**, Seoul (KR)

(Continued)

(**) Term: **14 Years**

Primary Examiner — Elizabeth J Oswecki

(21) Appl. No.: **29/497,879**

(74) *Attorney, Agent, or Firm* — Fenwick & West LLP

(22) Filed: **Jul. 29, 2014**

(30) **Foreign Application Priority Data**

(57) **CLAIM**

The ornamental design for an automated teller machine, as shown and described.

Feb. 3, 2014 (KR) 30-2014-0005323

(51) **LOC (10) Cl.** **20-01**

DESCRIPTION

(52) **U.S. Cl.**

USPC **D99/28**

(58) **Field of Classification Search**

USPC D99/28, 34, 35, 36, 43, 99;
D14/300–302, 305, 307, 900–902;
D18/3.1–3.3, 4.1–4.6, 12.1–12.3;
D21/324, 325, 329, 369, 370; 101/66;
109/1 R, 1 V, 2, 23, 24.1, 25, 58, 58.5,
109/66; 446/8–13; 705/16, 17, 18, 42, 43,
705/44, 45; 235/51, 379–382, 382.5, 386;
206/0.8, 0.81, 0.815, 0.82, 0.83, 0.84

CPC . G06Q 20/10; G06Q 20/108; G06Q 20/1085;
G06Q 20/18; G07D 11/00; G07D 1/00;
G07D 1/02; G07D 1/04; G07D 1/06; G07D
9/002; G07D 9/04; G07F 19/20; G07F
19/201; G07F 19/202; G07F 19/203; G07F
19/204; G07F 19/205; G07F 19/21; G07F
7/04; G07F 75/00; G07F 1/00; E05G 7/001;
E05G 1/006; A63H 33/001; A63H 33/006

See application file for complete search history.

FIG. 1 is a perspective view of an automated teller machine, showing our new design.

FIG. 2 is a front view of the automated teller machine of FIG. 1.

FIG. 3 is a rear view of the automated teller machine of FIG. 1.

FIG. 4 is a left side view of the automated teller machine of FIG. 1.

FIG. 5 is a right side view of the automated teller machine of FIG. 1.

FIG. 6 is a top view of the automated teller machine of FIG. 1; and,

FIG. 7 is a bottom view of the automated teller machine of FIG. 1.

The broken lines shown in the drawings represent portions of the automated teller machine that form no part of the claimed design.

1 Claim, 6 Drawing Sheets

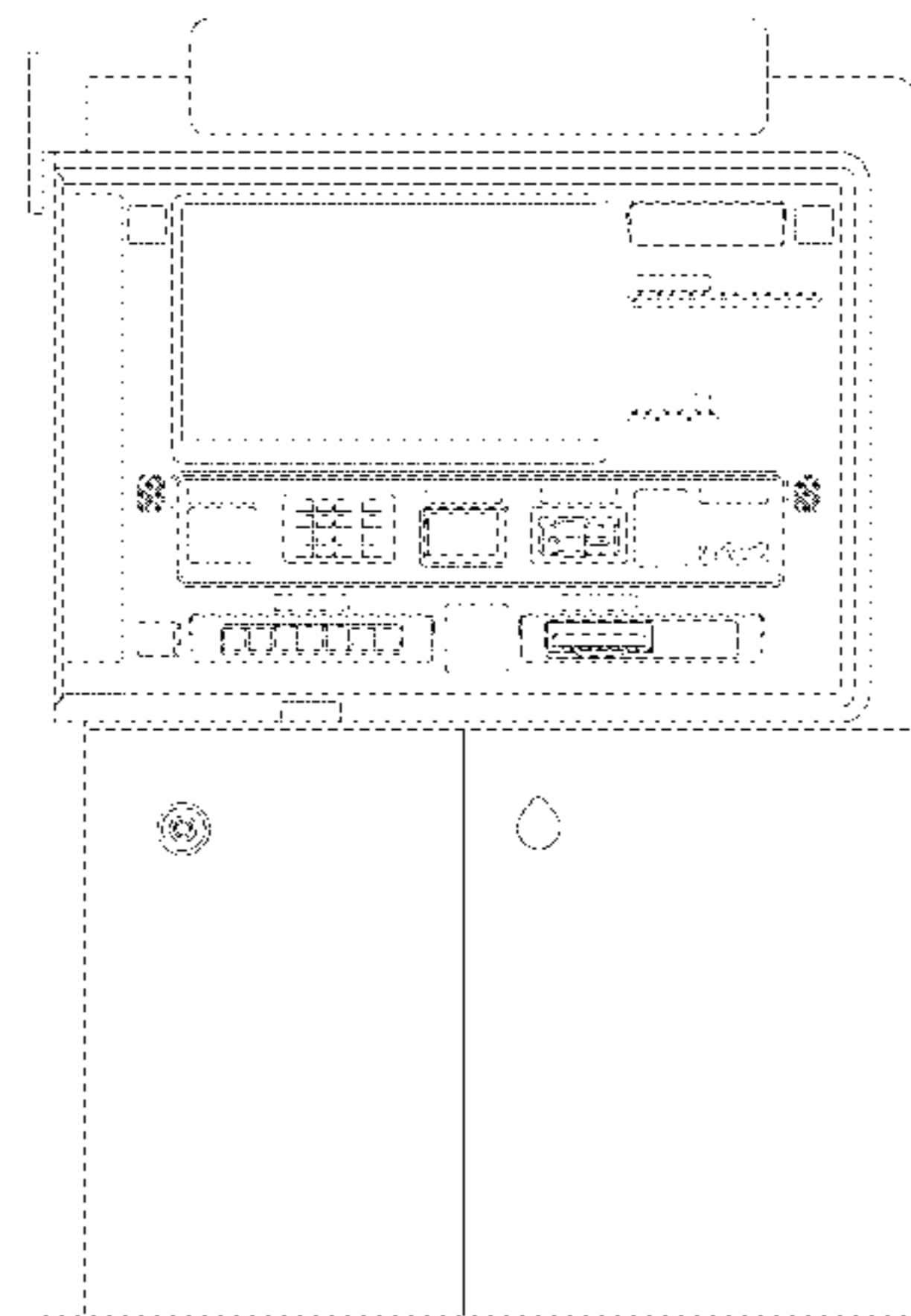
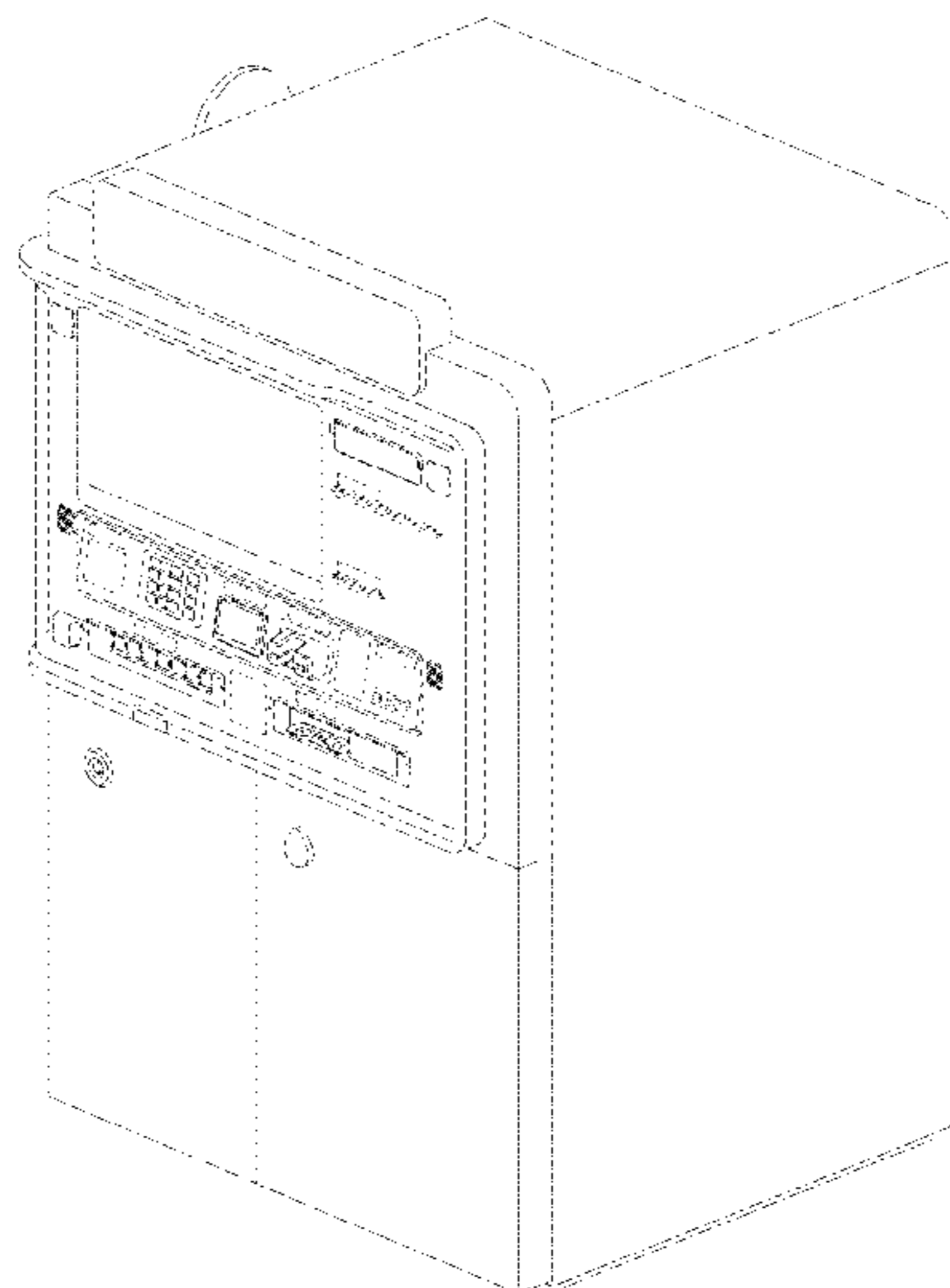

(56)

References Cited

U.S. PATENT DOCUMENTS

7,028,888	B2 *	4/2006	Laskowski	235/379						
D532,579	S *	11/2006	Kang et al.	D99/28						
D558,425	S *	12/2007	Dias	D99/28						
D584,875	S *	1/2009	Bleck	D99/28						
D597,275	S *	7/2009	Lee	D99/28						
D625,305	S *	10/2010	Bleck et al.	D14/307						
D625,485	S *	10/2010	Lee et al.	D99/28						
D629,585	S *	12/2010	Bleck et al.	D99/28						
7,959,072	B1 *	6/2011	Jenkins et al.	235/379						
7,989,460	B2 *	8/2011	Hennequin	514/266.1						
						D653,012	S *	1/2012	Rohan et al.	D99/28
						D653,014	S *	1/2012	Rohan et al.	D99/28
						D672,525	S *	12/2012	Lee et al.	D99/28
						D696,484	S *	12/2013	Lee et al.	D99/28
						D696,485	S *	12/2013	Lee et al.	D99/28
						D724,290	S *	3/2015	Cha et al.	D99/28
						D724,812	S *	3/2015	Cha et al.	D99/28
						2004/0262379	A1 *	12/2004	Gomes	235/379
						2005/0029340	A1 *	2/2005	Ferraro	235/379
						2006/0073883	A1 *	4/2006	Franks	463/25
						2008/0265019	A1 *	10/2008	Artino et al.	235/379
						2008/0296365	A1 *	12/2008	Schliebe	235/379
						2010/0161489	A1 *	6/2010	Goodall et al.	705/45

* cited by examiner

Fig 1

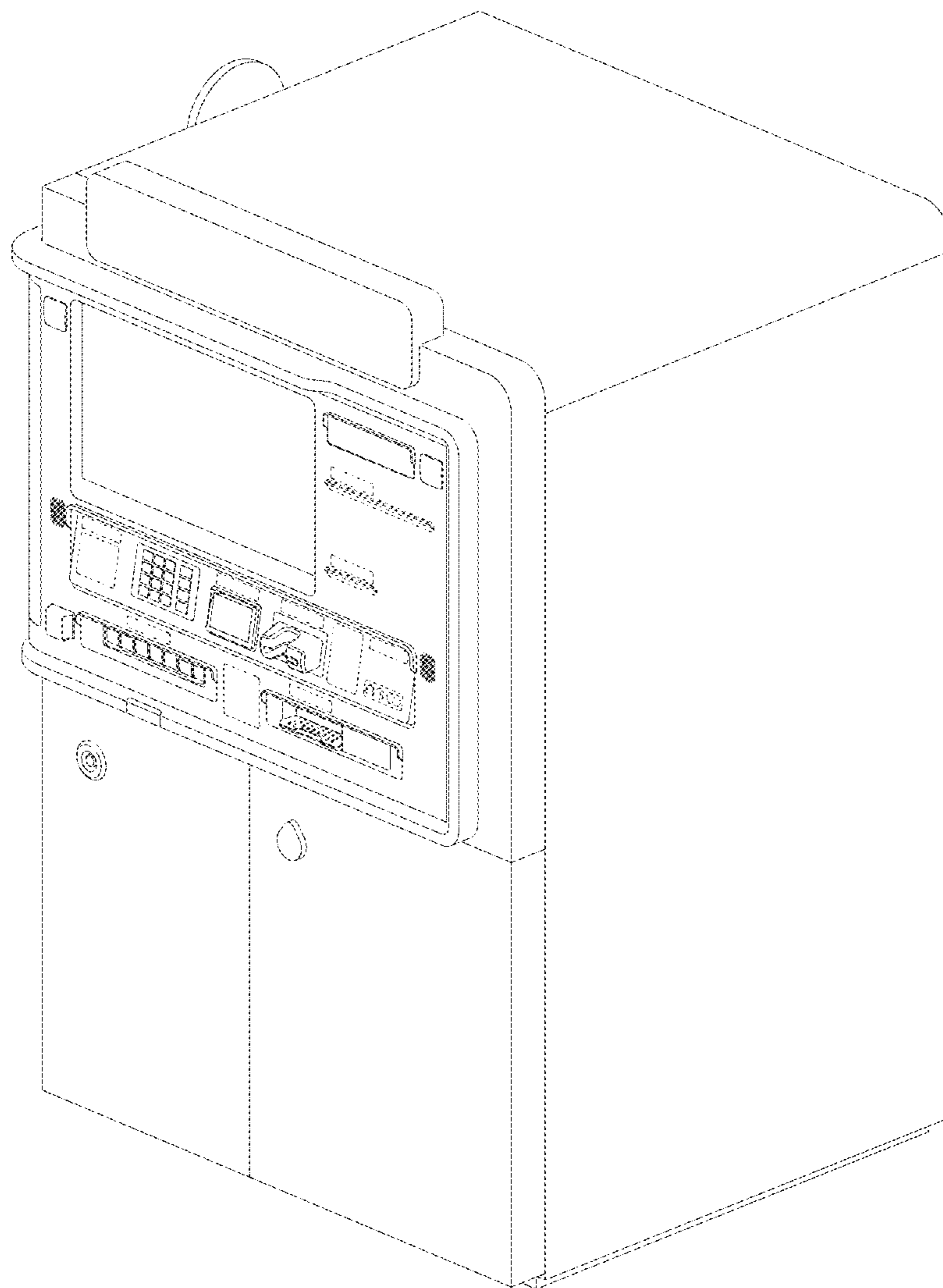

Fig 2

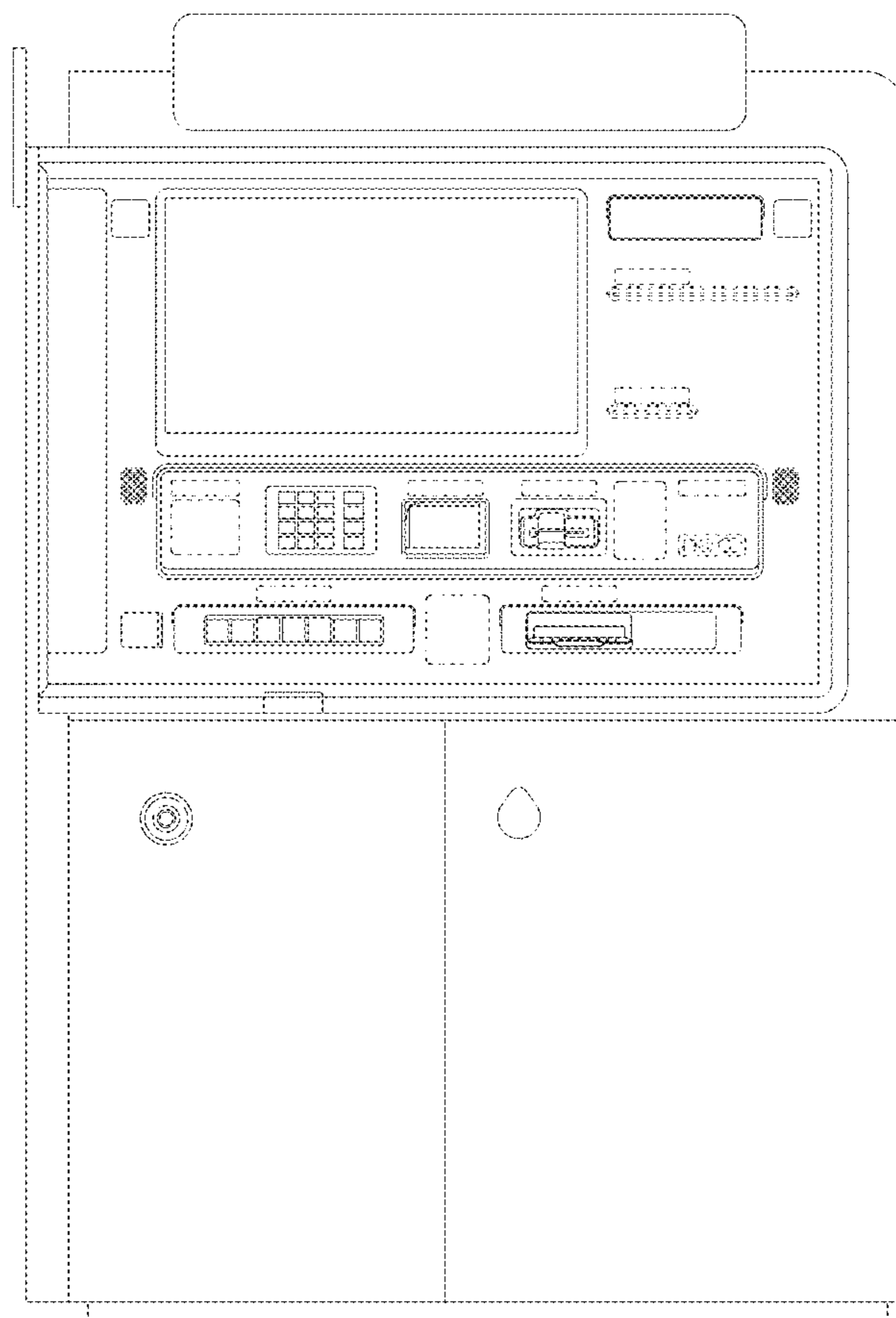

Fig 3

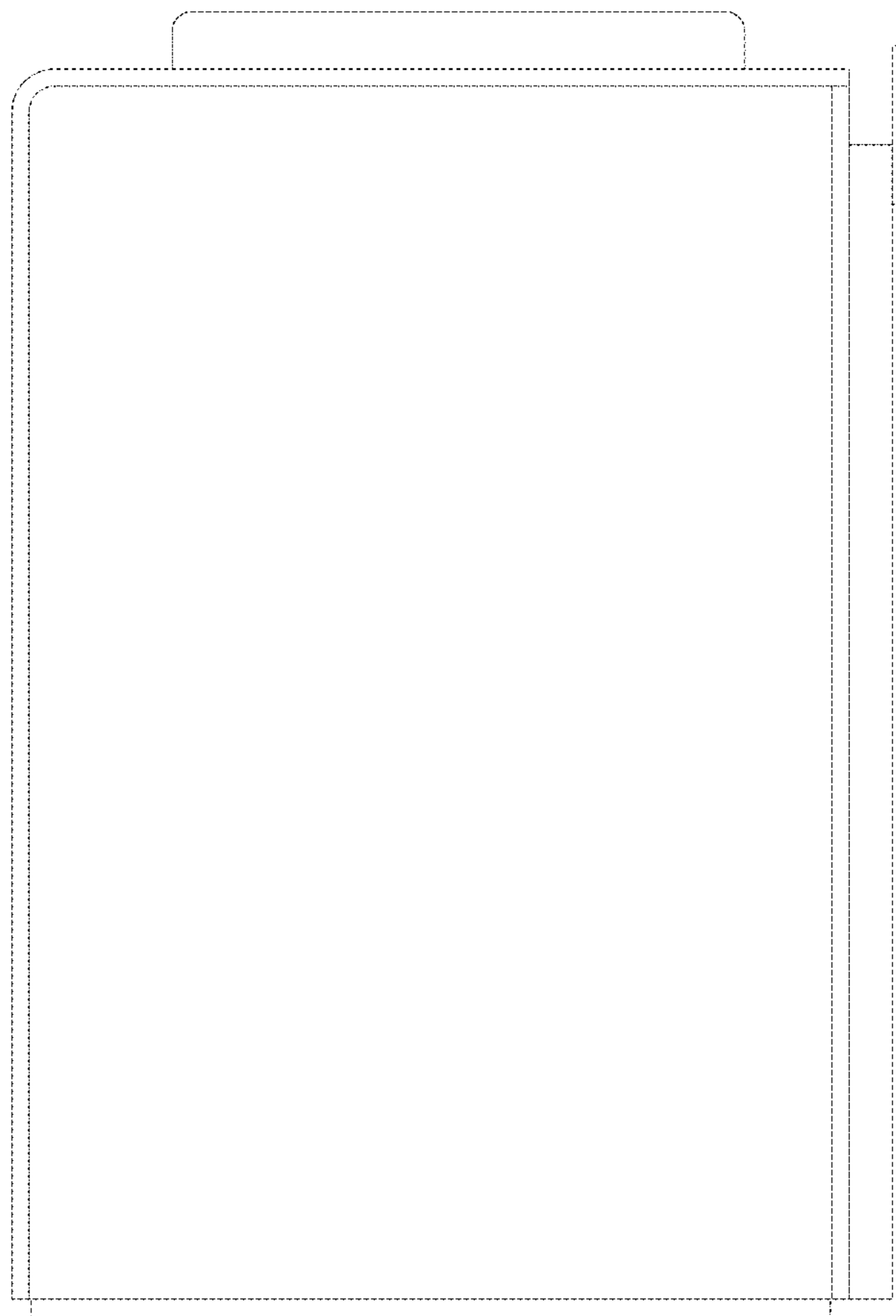

Fig 4

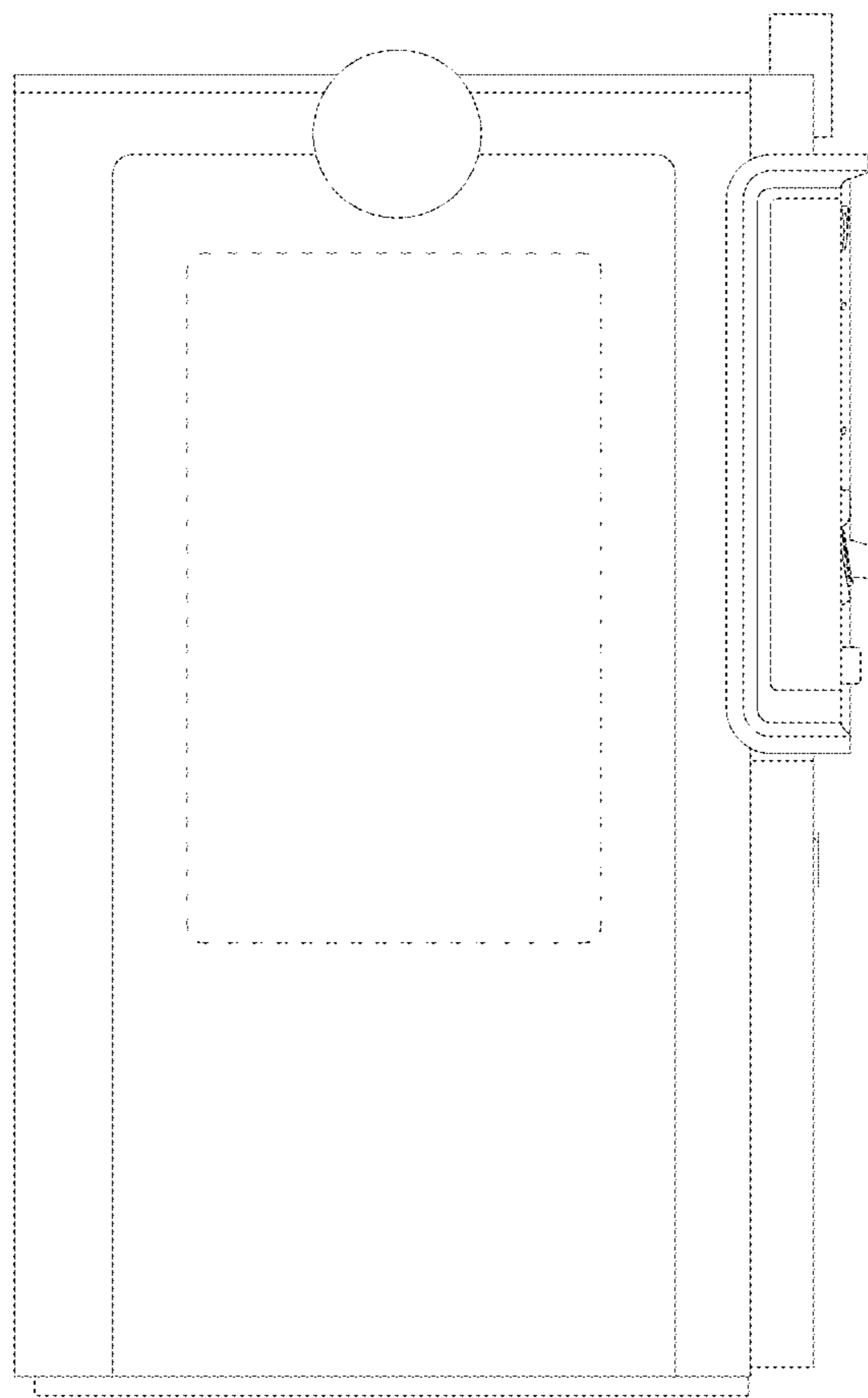

Fig 5

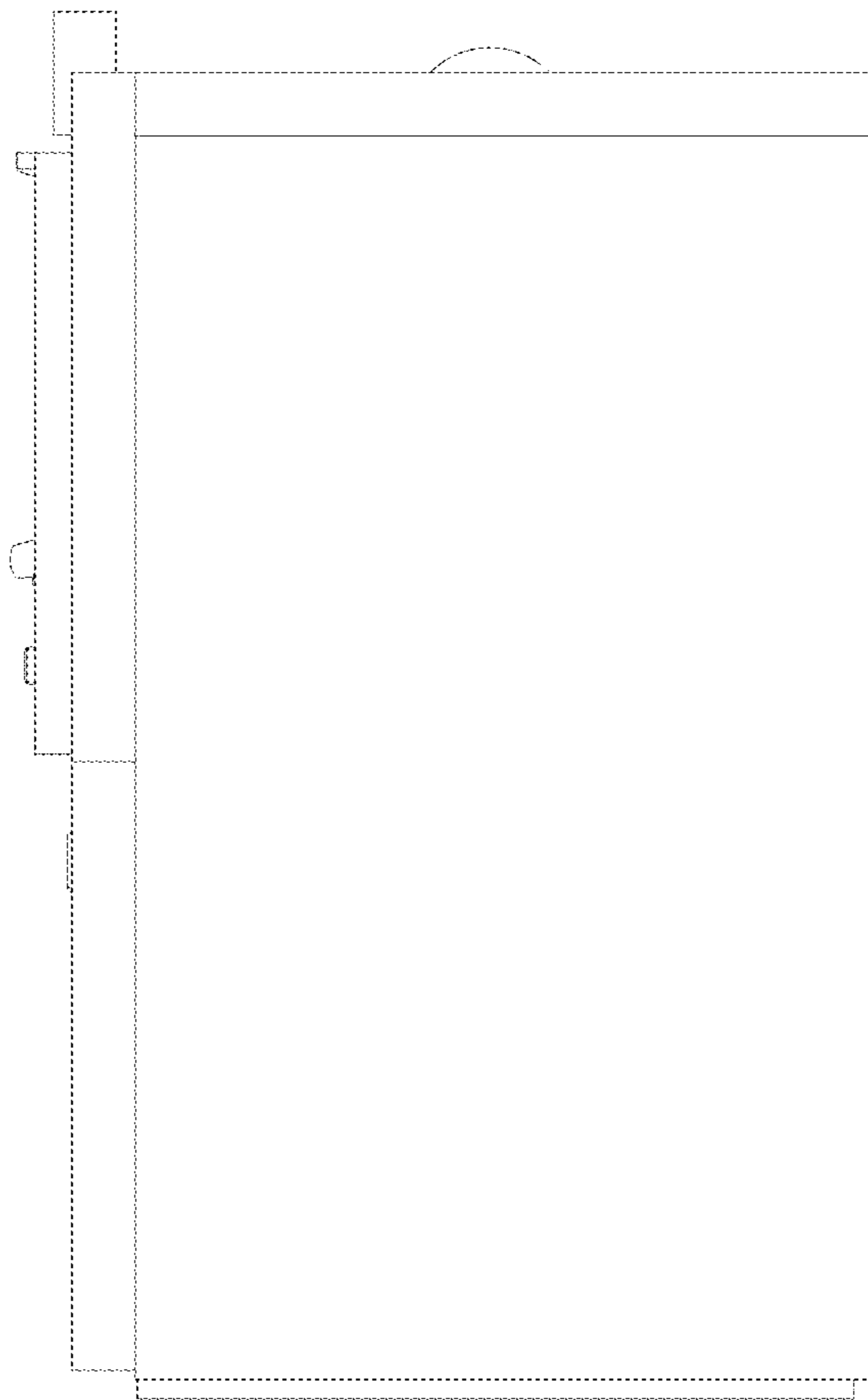

Fig 6

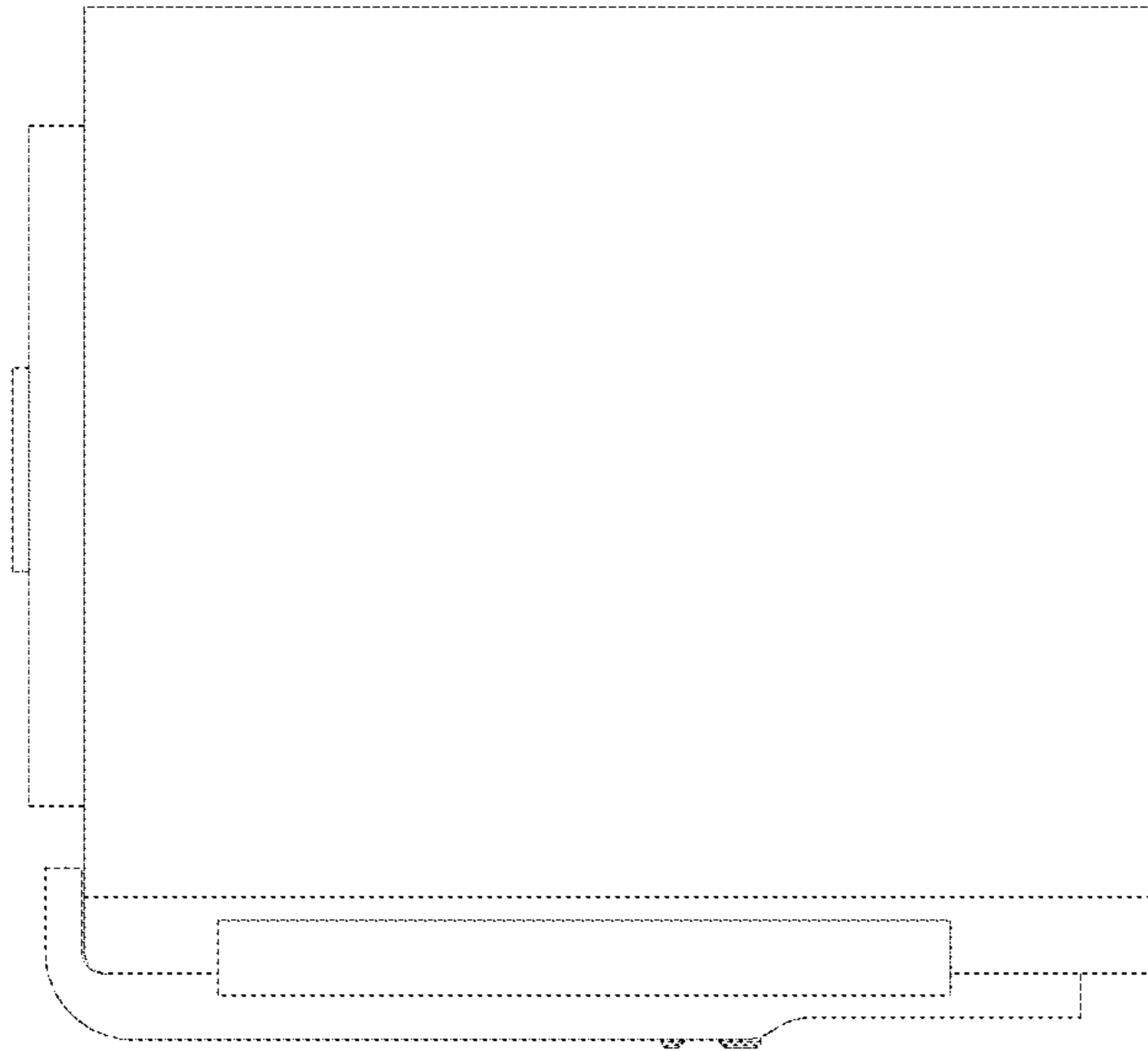

Fig 7

