



US00D746523S

(12) **United States Design Patent**  
**Jin**

(10) **Patent No.:** **US D746,523 S**  
(45) **Date of Patent:** **\*\* Dec. 29, 2015**

(54) **VACUUM CLEANER**

(71) Applicant: **Alfred Kaercher GmbH & Co. KG**,  
Winnenden (DE)

(72) Inventor: **Zheyi Jin**, Schwaikheim (DE)

(73) Assignee: **Alfred Kaercher GmbH & Co. KG**,  
Winnenden (DE)

(\*\*) Term: **14 Years**

(21) Appl. No.: **29/486,974**

(22) Filed: **Apr. 4, 2014**

(30) **Foreign Application Priority Data**

Oct. 4, 2013 (WO) ..... DM/081 864

(51) **LOC (10) Cl.** ..... **15-05**

(52) **U.S. Cl.**  
USPC ..... **D32/21**

(58) **Field of Classification Search**  
USPC ..... D32/21, 23-24, 31  
CPC ..... A47L 5/362; A47L 5/365; A47L 5/28;  
A47L 9/26; A47L 11/34; A47L 7/0038;  
B65H 75/18

See application file for complete search history.

(56) **References Cited**

**U.S. PATENT DOCUMENTS**

D333,195 S \* 2/1993 Oberdorfer-Bogel ..... D32/23  
D333,890 S \* 3/1993 Oberdorfer-Bogel ..... D32/23  
D334,258 S \* 3/1993 Oberdorfer-Bogel ..... D32/23  
D581,608 S \* 11/2008 Dammkoehler et al. .... D32/21  
D633,665 S \* 3/2011 Dammkoehler ..... D32/21  
D655,874 S \* 3/2012 Dammkoehler ..... D32/24  
D667,597 S \* 9/2012 Dammkoehler ..... D32/21  
D669,646 S \* 10/2012 Theising et al. .... D32/23

D715,505 S \* 10/2014 Dammkoehler ..... D32/21  
D725,328 S \* 3/2015 Aglassinger et al. .... D32/21  
D725,329 S \* 3/2015 Aglassinger et al. .... D32/21  
2015/0074936 A1 \* 3/2015 Plato et al. .... 15/324

**OTHER PUBLICATIONS**

Extract from catalog of Alfred Kaercher GmbH & Co. KG, "Programme 2009 Kaercher Professional Commercial", cover, pp. 85-87, 94-101 and last page. (Mar. 2009).

Extract from catalog of Alfred Kaercher GmbH & Co. KG, "Programme 2009 Kaercher Residential", cover, pp. 81, 83, 86, 87 and last page. (Mar. 2009).

Extract from catalog of Alfred Kaercher GmbH & Co. KG, "Programme 2010 Kaercher Home & Garden", cover, pp. 80-85, 89 and last page. (Nov. 2009).

Extract from catalog of Alfred Kaercher GmbH & Co. KG, "Programme 2010 Kaercher Professional", cover, pp. 94-105 and last page. (Nov. 2009).

Extract from catalog of Alfred Kaercher GmbH & Co. KG, "Programme 2011 Kaercher Professional", cover, pp. 120-134, 136, 138, 142, 148 and last page. (Nov. 2010).

(Continued)

*Primary Examiner* — Ruth McInroy

(74) *Attorney, Agent, or Firm* — Lipsitz & McAllister, LLC

(57) **CLAIM**

The ornamental design for a vacuum cleaner, as shown and described.

**DESCRIPTION**

FIG. 1 is a front, top and left side perspective view of a vacuum cleaner showing the new design;

FIG. 2 is a front, top and right side perspective view thereof;

FIG. 3 is a front elevational view thereof;

FIG. 4 is a left side elevational view thereof;

FIG. 5 is a rear elevational view thereof;

FIG. 6 is a right side elevational view thereof; and,

FIG. 7 is a top plan view thereof.

**1 Claim, 7 Drawing Sheets**

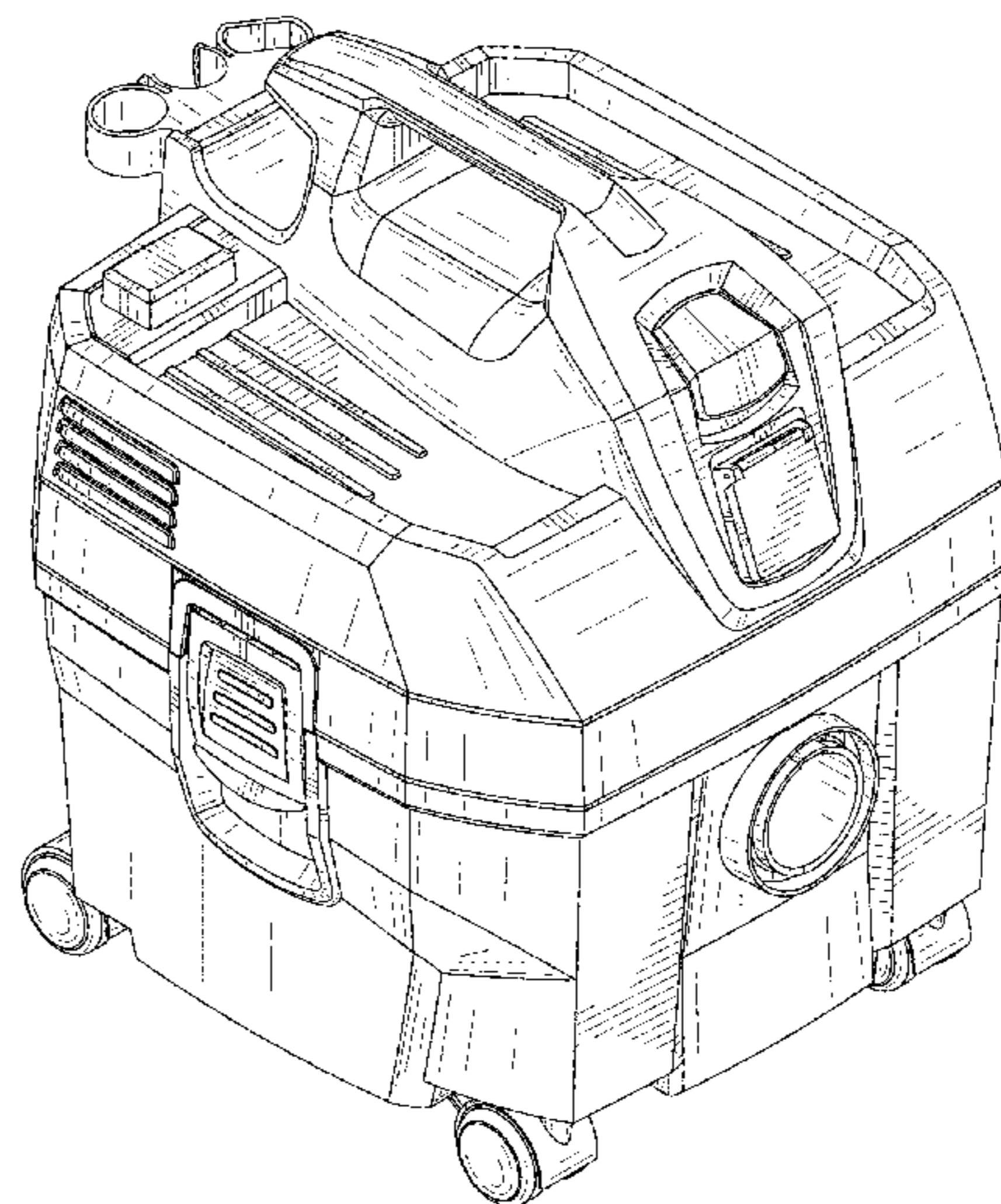
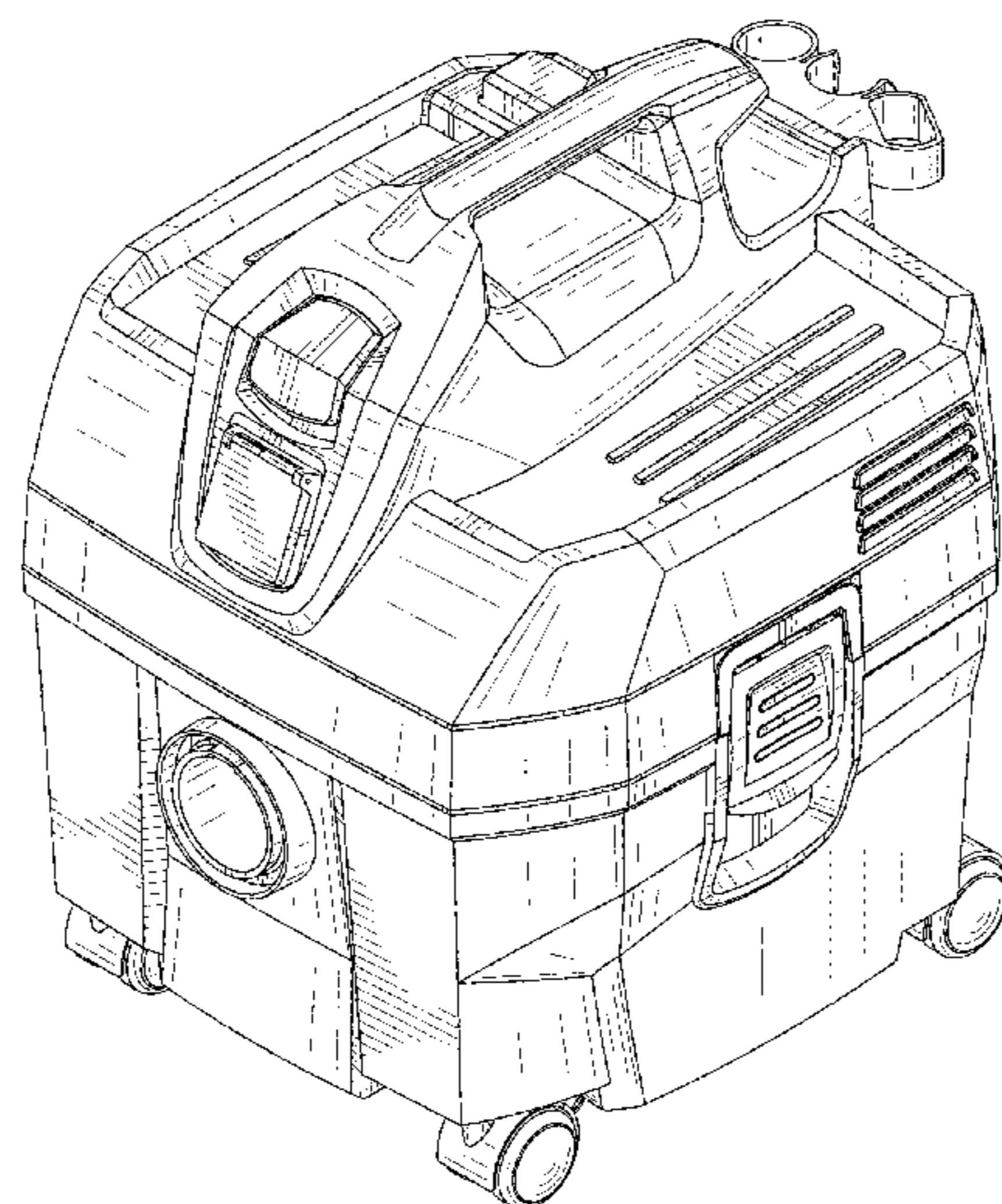

(56)

**References Cited**

OTHER PUBLICATIONS

Extract from catalog of Alfred Kaercher GmbH & Co. KG, "Programme 2012 Kaercher Professional (Professional Industrial)", cover, pp. 108, 110, 111, 115-118 and last page. (Nov. 2011).

Extract from catalog of Alfred Kaercher GmbH & Co. KG, "Programme 2012 Kaercher Professional", cover, pp. 126-134, 136, 138, 140, 142, 144, 146, 148, 150, 151, 162 and last page. (Nov. 2011).

Extract from catalog of Alfred Kaercher GmbH & Co. KG, "Programme 2012 Kaercher Home & Garden", cover, pp. 72-81 and last page. (Oct. 2011).

Extract from catalog of Alfred Kaercher GmbH & Co. KG, "Programme 2013 Kaercher Home & Garden", cover, pp. 70-86 and last page. (Oct. 2012).

Extract from catalog of Alfred Kaercher GmbH & Co. KG, "Programme 2013 Kaercher Xpert", cover, pp. 14, 15 and last page (Nov. 2012).

Extract from catalog of Alfred Kaercher GmbH & Co. KG, "Programme 2013 Kaercher Professional", cover, pp. 238, 240-267 and last page (Nov. 2012).

\* cited by examiner

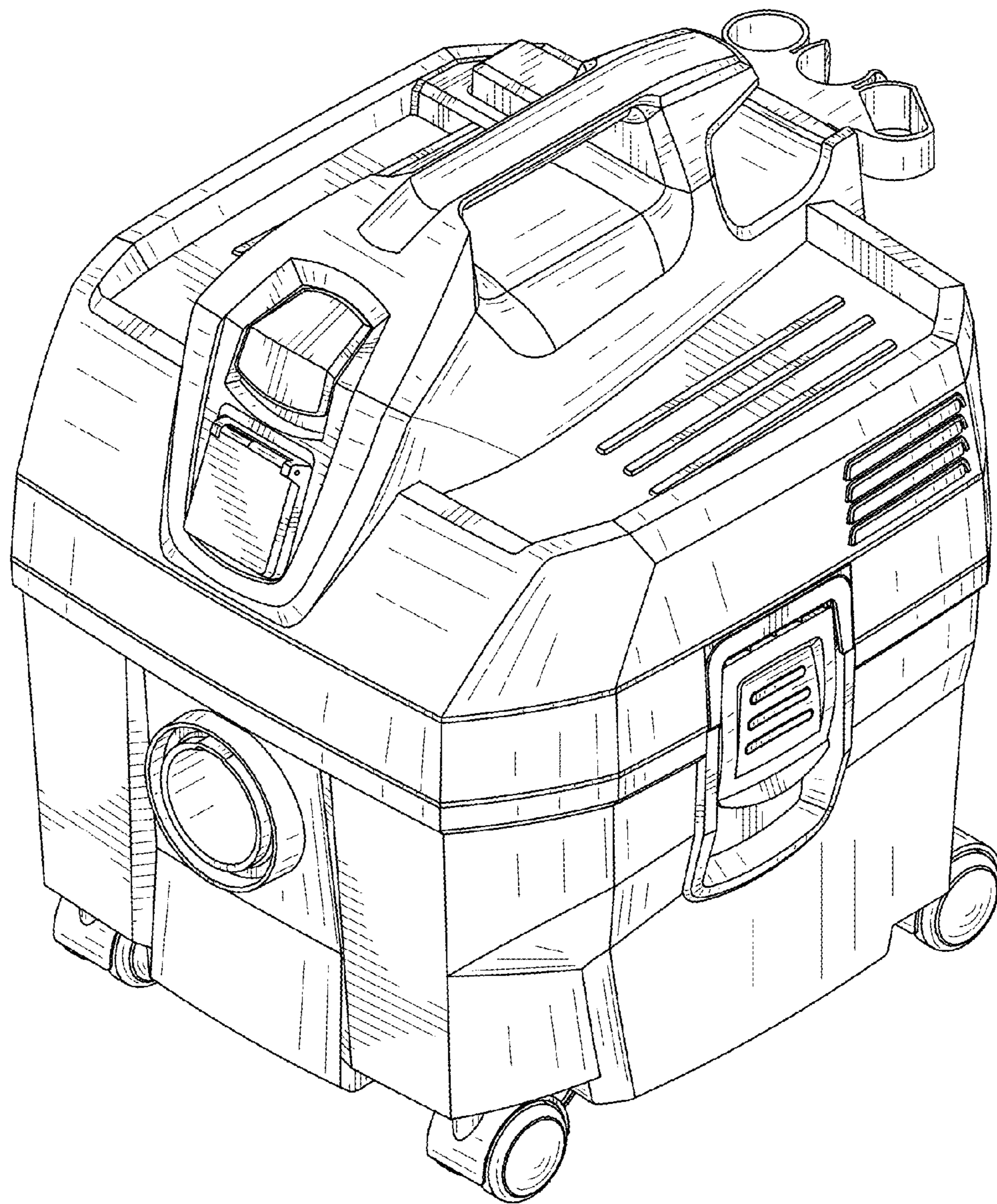

FIG. 1

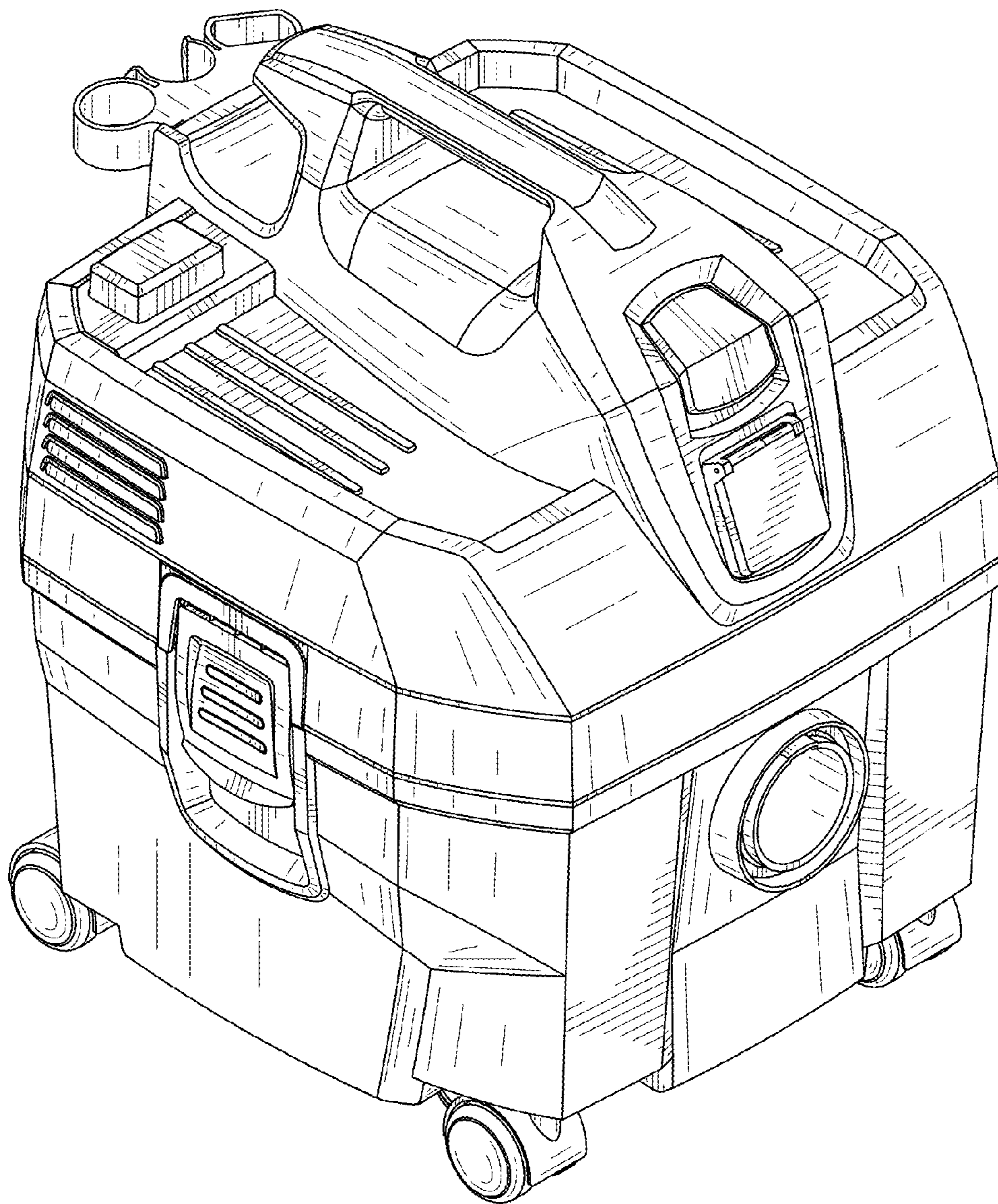

FIG. 2

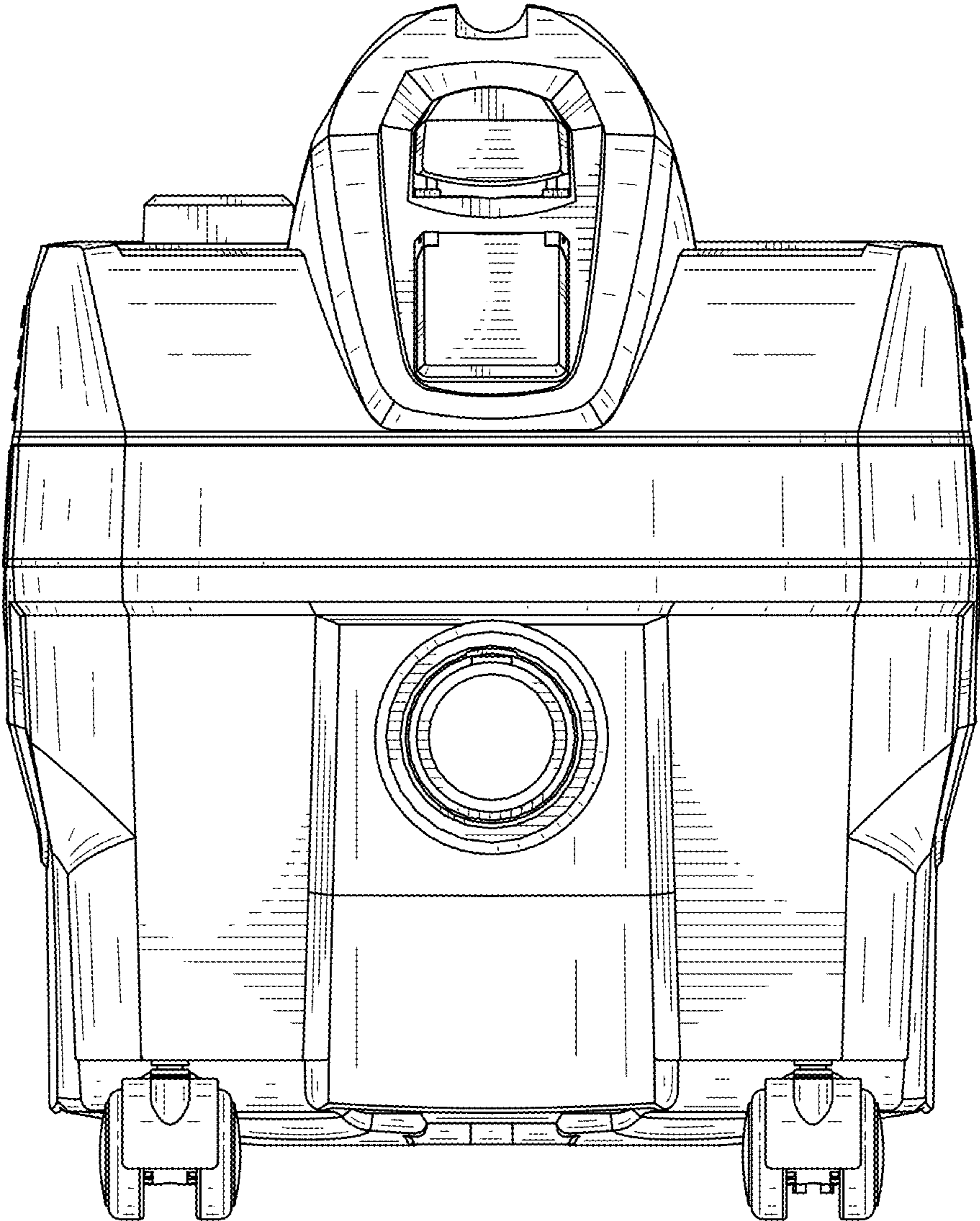

FIG. 3

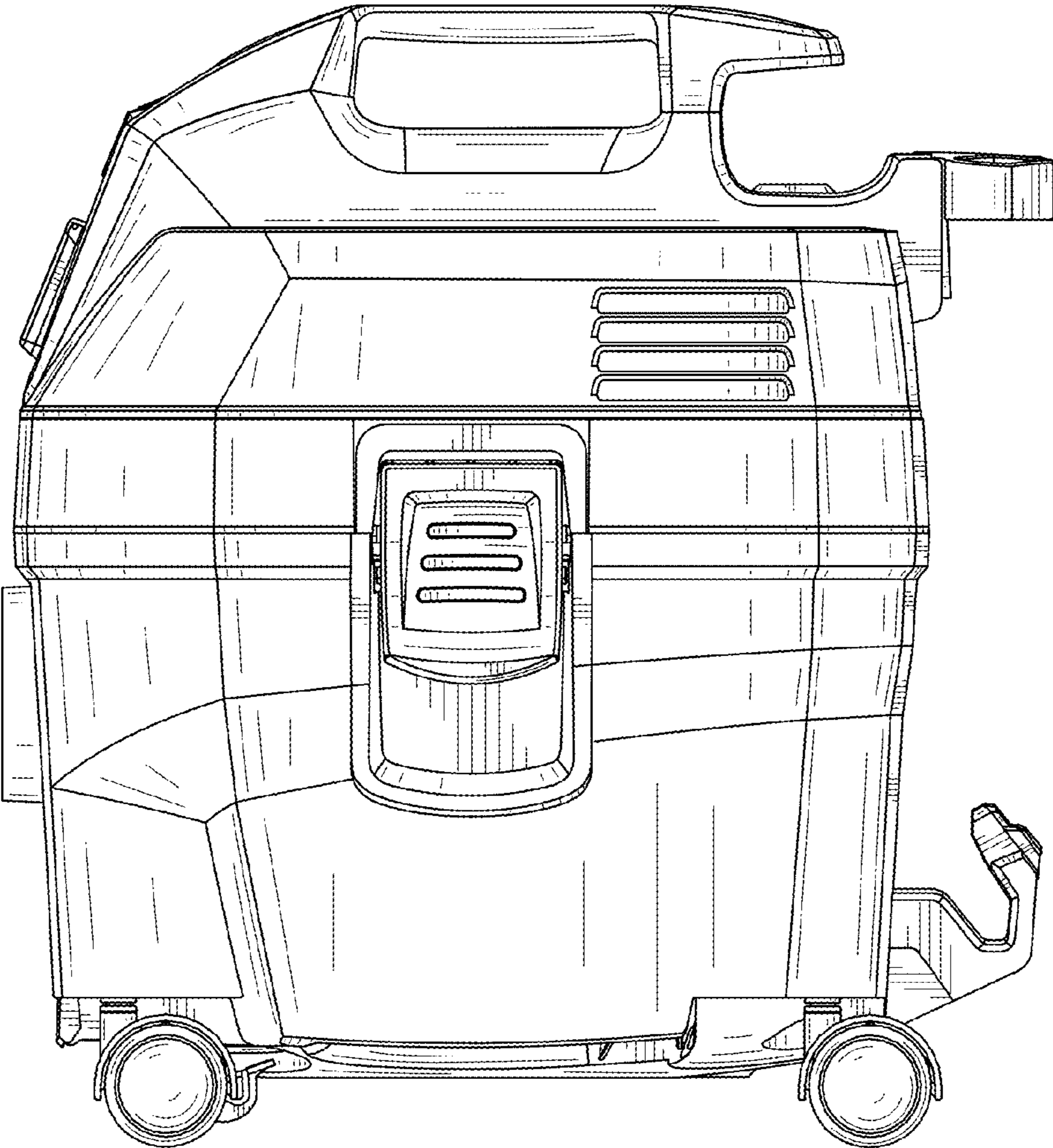

FIG. 4

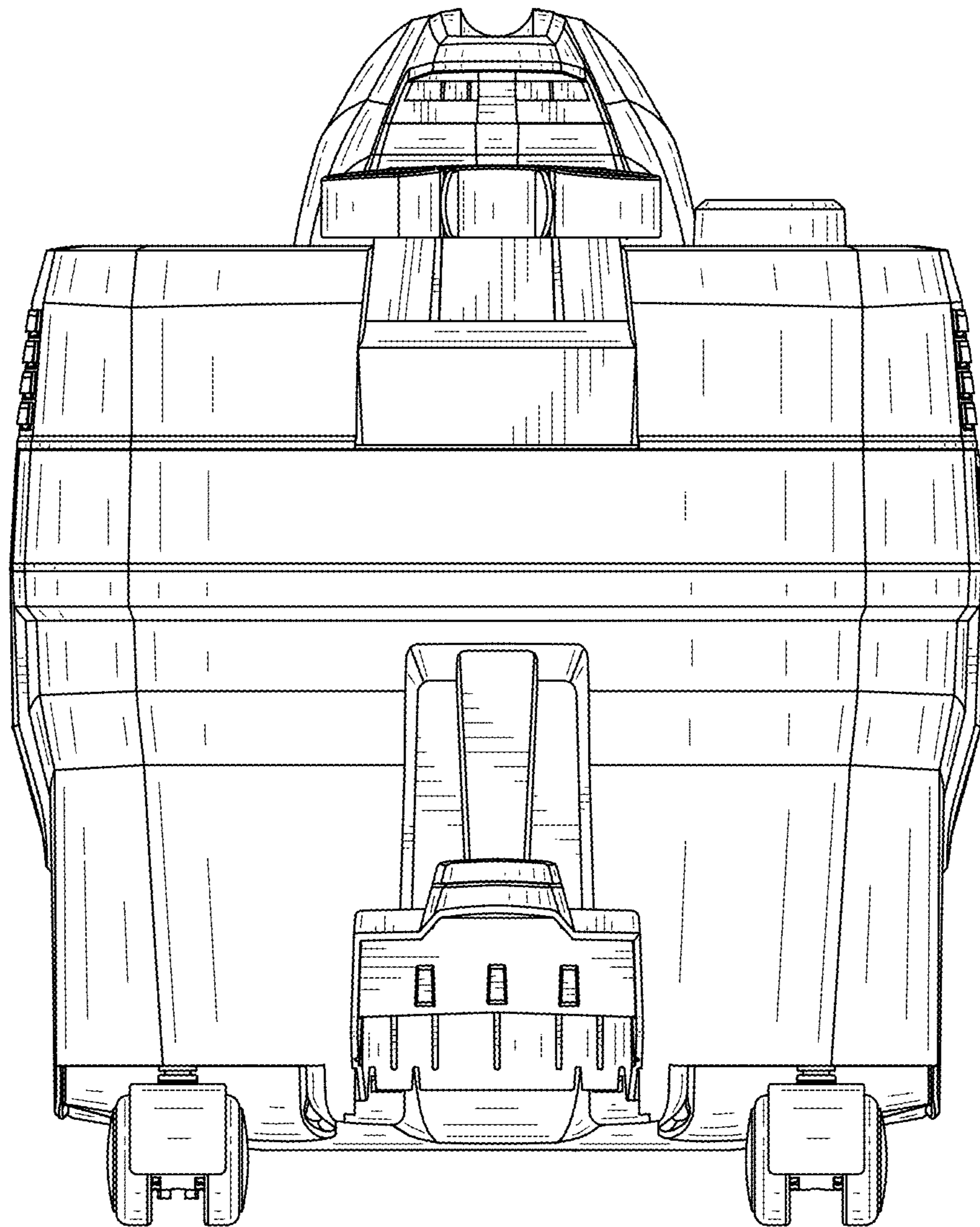

FIG. 5

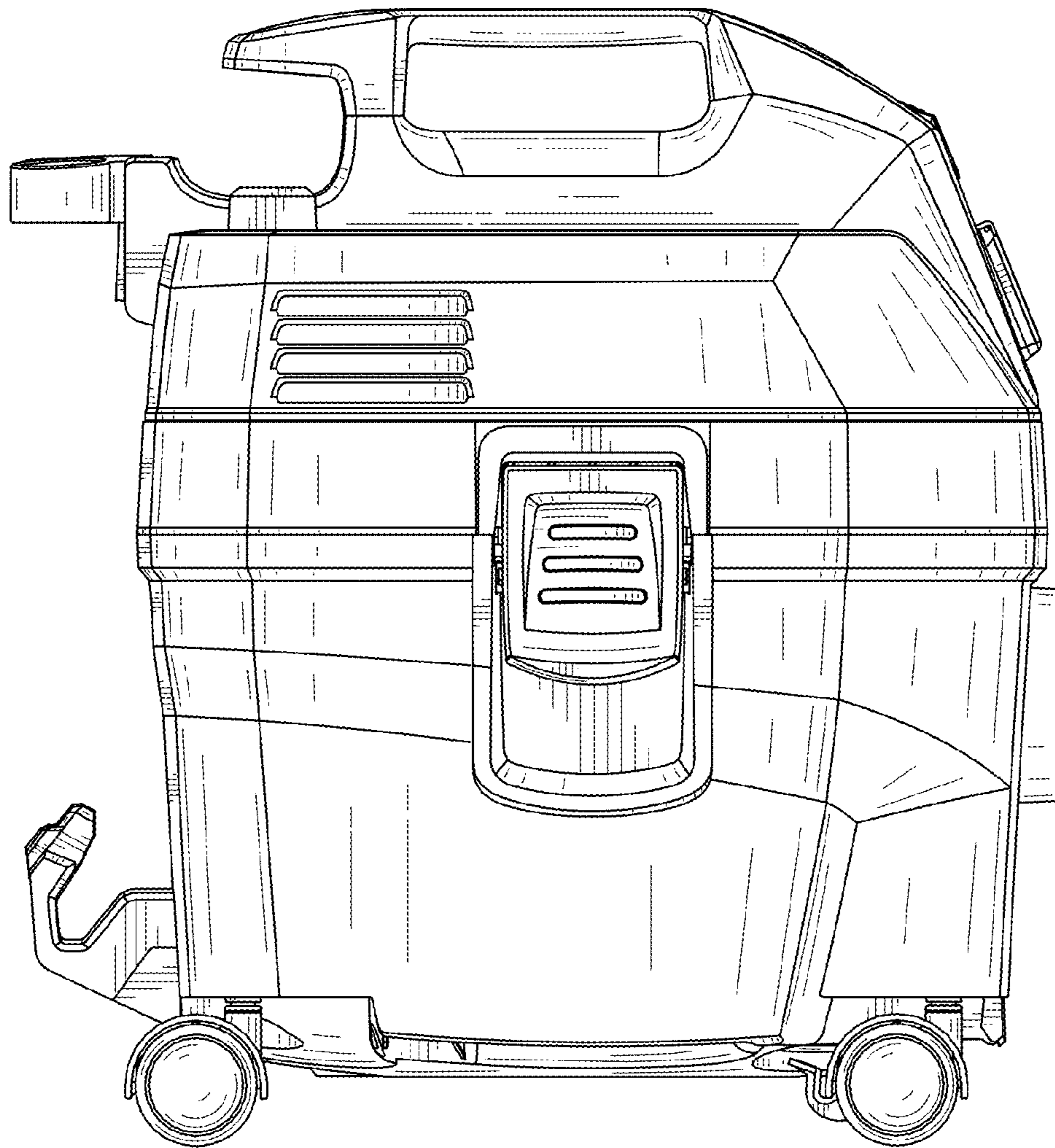
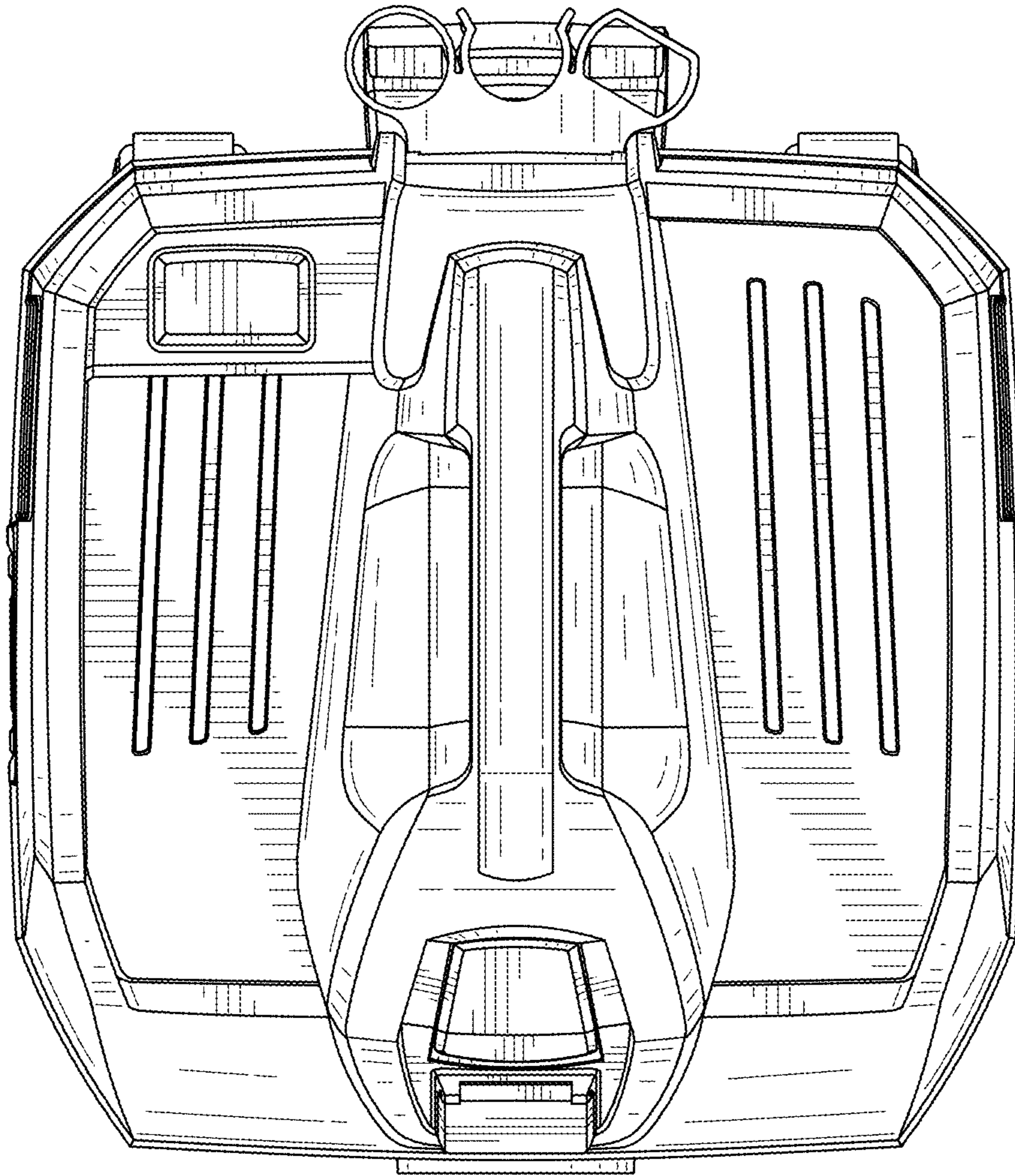

FIG. 6





**FIG. 7**