



US00D746391S

(12) **United States Design Patent**
Wilkes et al.

(10) **Patent No.:** **US D746,391 S**

(45) **Date of Patent:** **** Dec. 29, 2015**

(54) **SURFCRAFT FIN**

(71) Applicant: **Leading Edge Surfboards Pty Ltd,**
Victoria (AU)

(72) Inventors: **Darryl James Wilkes,** Victoria (AU);
Francine Viola Wilkes, Victoria (AU)

(73) Assignee: **Leading Edge Surfboards Pty Ltd**
(AU)

(**) Term: **14 Years**

(21) Appl. No.: **29/501,169**

(22) Filed: **Sep. 2, 2014**

(51) **LOC (10) Cl.** **21-02**

(52) **U.S. Cl.**
USPC **D21/778**

(58) **Field of Classification Search**
USPC D21/684–685, 760–761, 765–766,
D21/768–777, 778; 114/253, 345–346;
441/74–75; 472/128–129; D12/5, 6,
D12/316; 280/601, 609, 637, 11.36
CPC B63B 35/79; B63B 35/73; B63B 1/00
See application file for complete search history.

(56) **References Cited**

U.S. PATENT DOCUMENTS

D257,786 S *	1/1981	Vann	D21/778
4,320,546 A *	3/1982	Knox	441/74
D267,666 S *	1/1983	Vann	D21/778
D307,310 S *	4/1990	Bucknell	D21/778
6,254,446 B1 *	7/2001	Thigpen	441/79
D528,166 S *	9/2006	Wright	D21/769

* cited by examiner

Primary Examiner — Zenia Bennett

(74) *Attorney, Agent, or Firm* — Lerner, David, Littenberg,
Krumholz & Mentlik, LLP

(57) **CLAIM**

The ornamental design for a surfcraft fin, as shown and described.

DESCRIPTION

FIG. 1 is a bottom front perspective view of a surfcraft fin according to a first embodiment of our design; FIG. 2 is a bottom rear perspective view thereof; FIG. 3 is a front view thereof; FIG. 4 is a rear view thereof; FIG. 5 is a first side view thereof; FIG. 6 is a second side view thereof; FIG. 7 is a top view thereof; FIG. 8 is a bottom view thereof; FIG. 9 is a bottom front perspective view of a surfcraft fin according to a second embodiment of our design; FIG. 10 is a bottom rear perspective view thereof; FIG. 11 is a front view thereof; FIG. 12 is a rear view thereof; FIG. 13 is a first side view thereof; FIG. 14 is a second side view thereof; FIG. 15 is a top view thereof; FIG. 16 is a bottom view thereof; FIG. 17 is a bottom front perspective view of a surfcraft fin according to a third embodiment of our design; FIG. 18 is a bottom rear perspective view thereof; FIG. 19 is a front view thereof; FIG. 20 is a rear view thereof; FIG. 21 is a first side view thereof; FIG. 22 is a second side view thereof; FIG. 23 is a top view thereof; and, FIG. 24 is a bottom view thereof. Broken lines are environmental only and form no part of the claimed design.

1 Claim, 24 Drawing Sheets

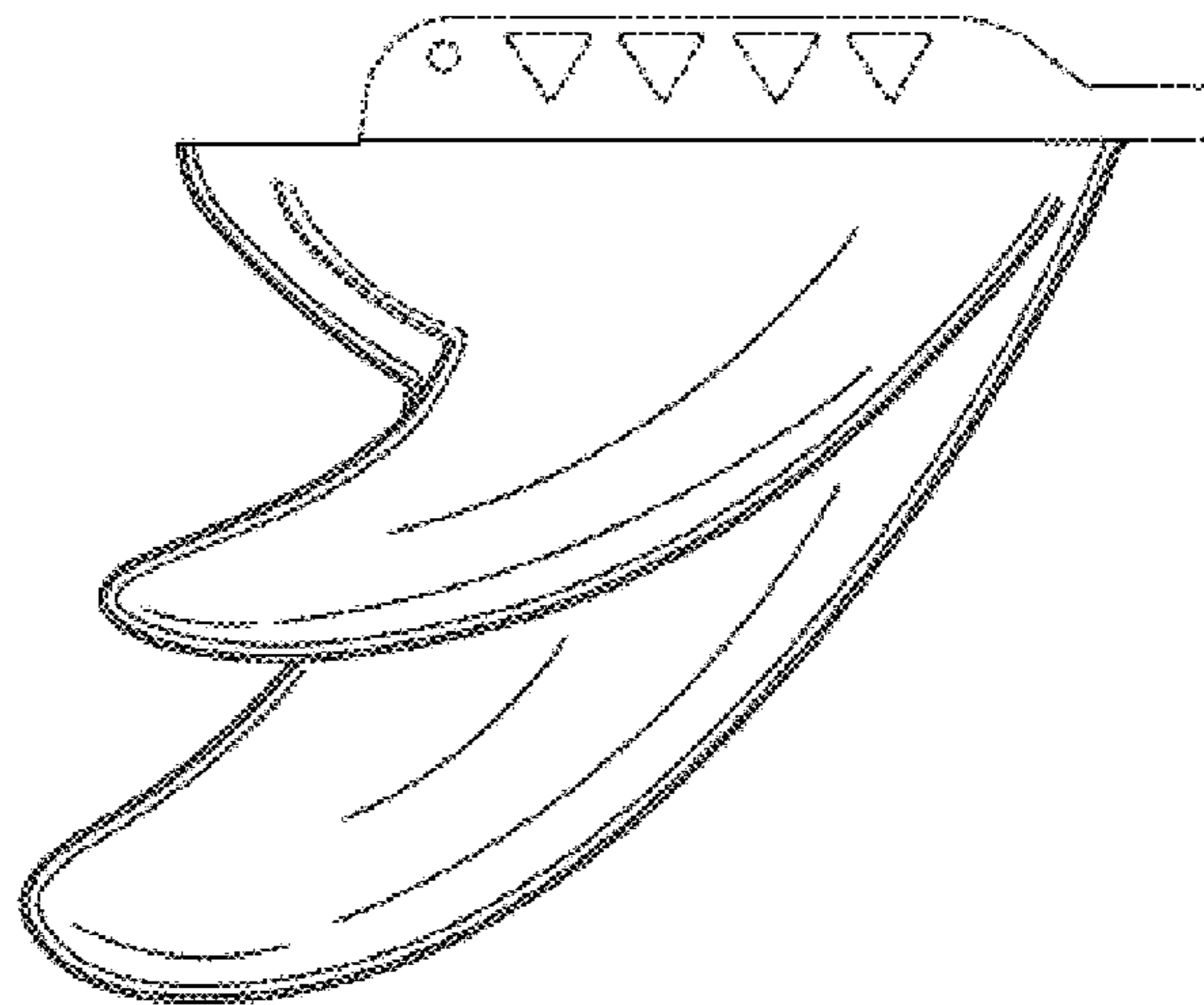
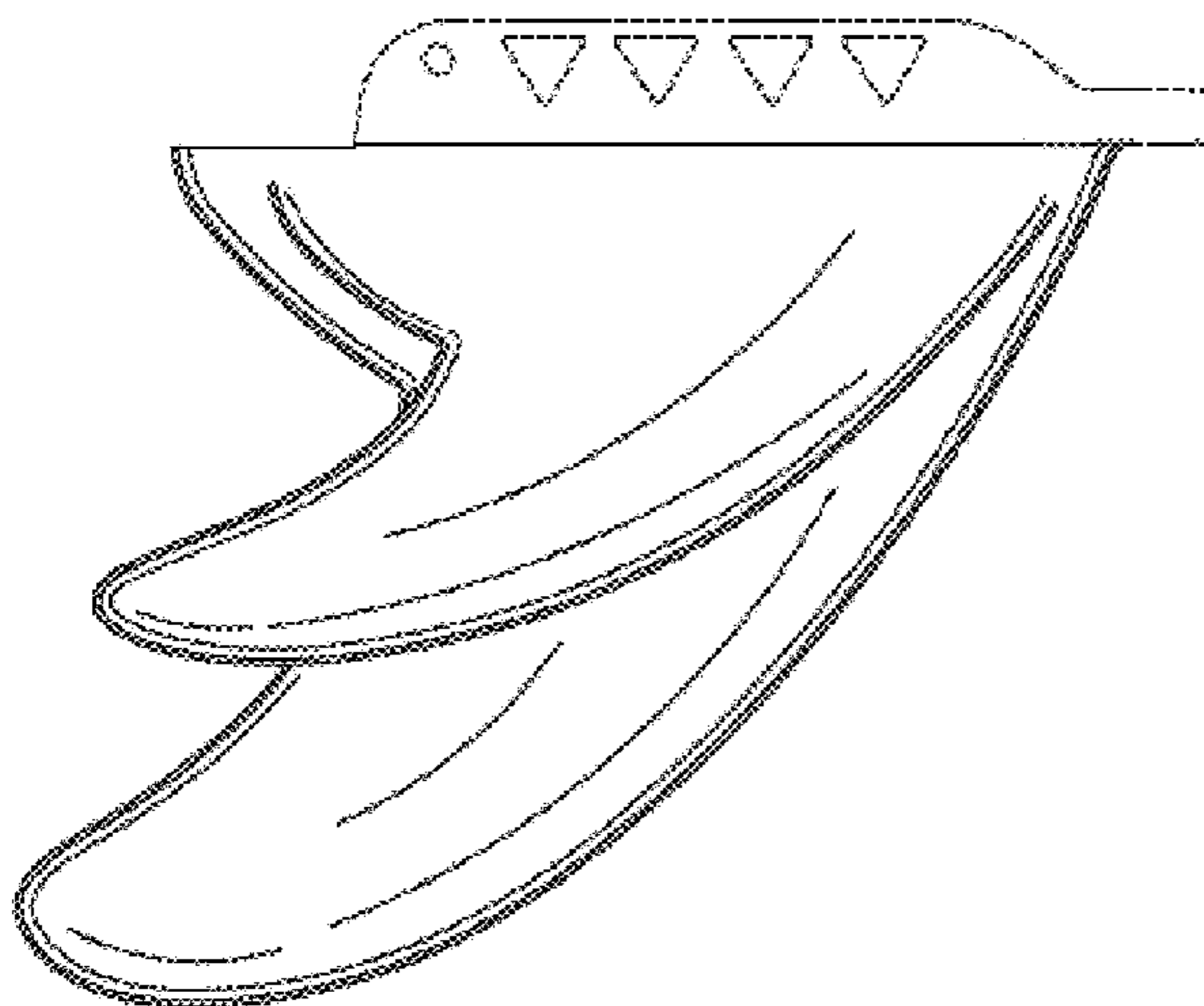

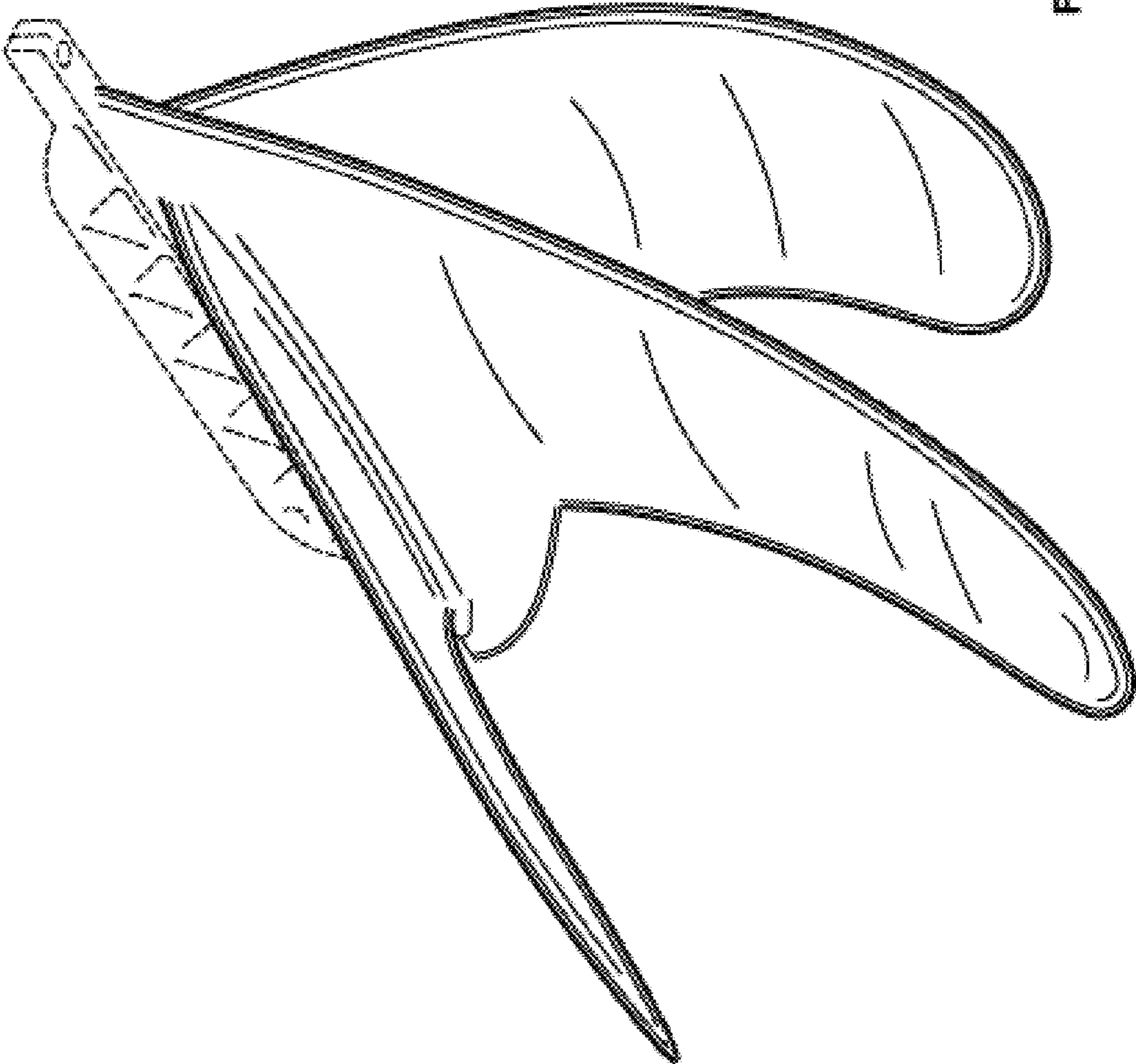

FIGURE 1

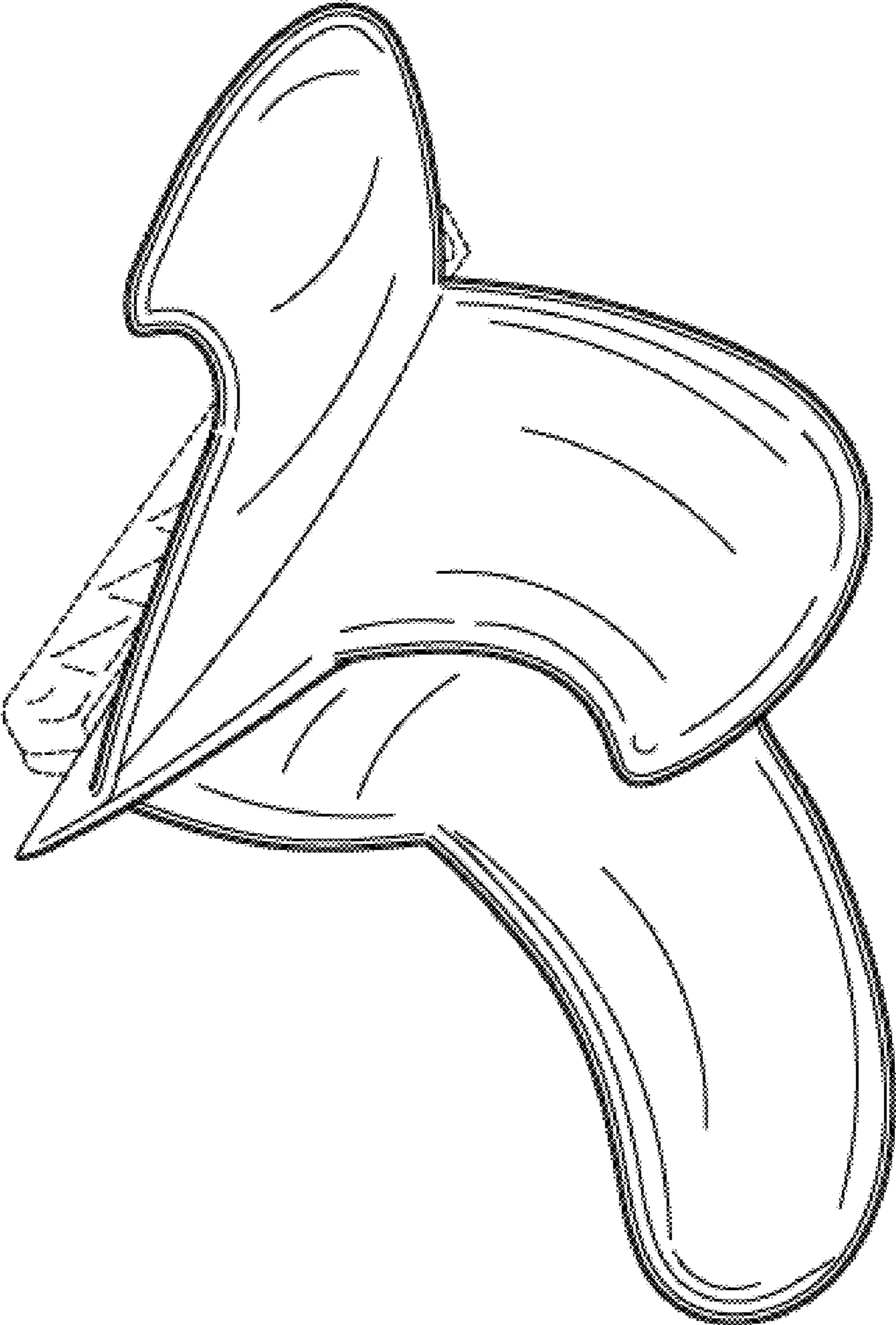

FIGURE 2

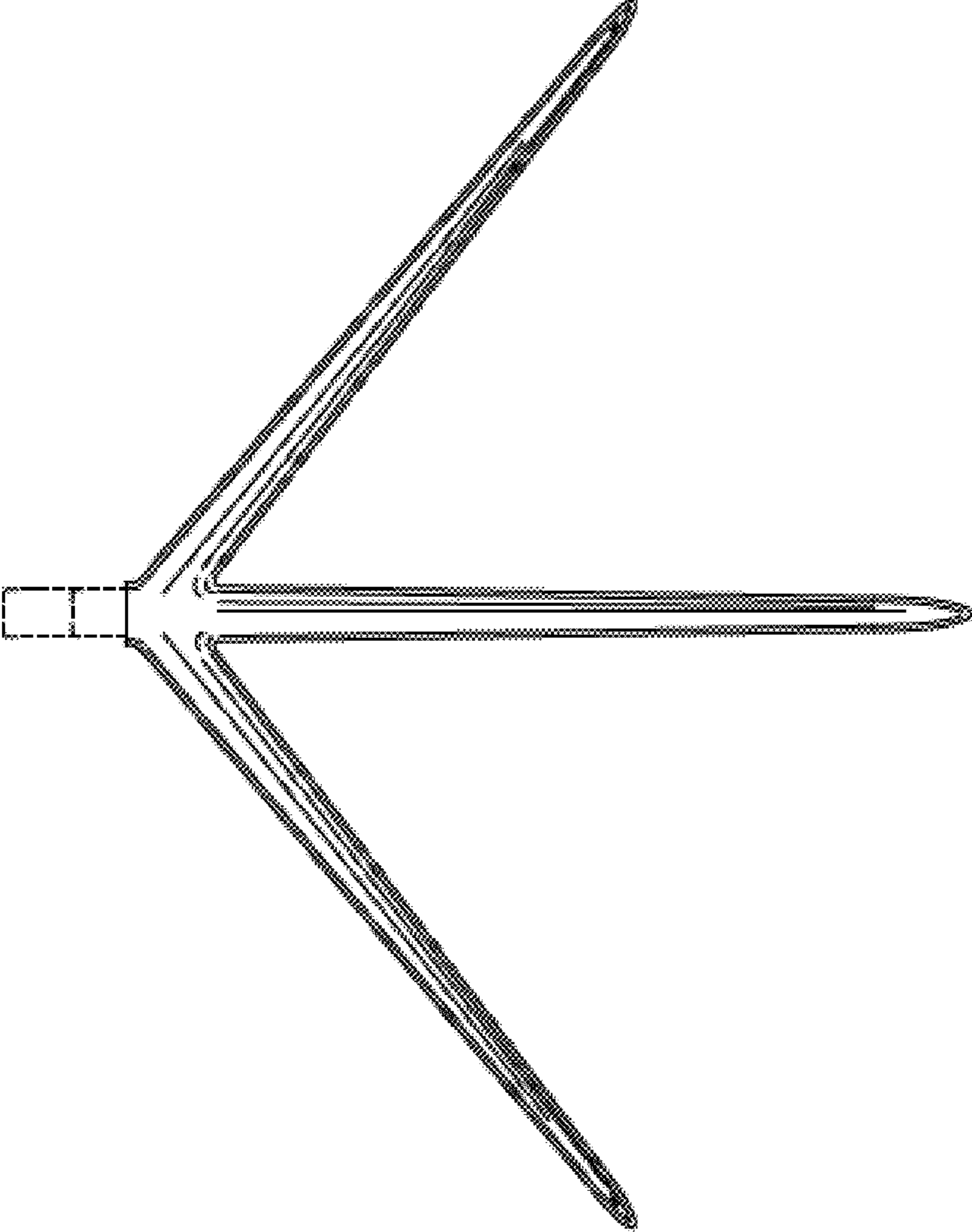

FIGURE 3

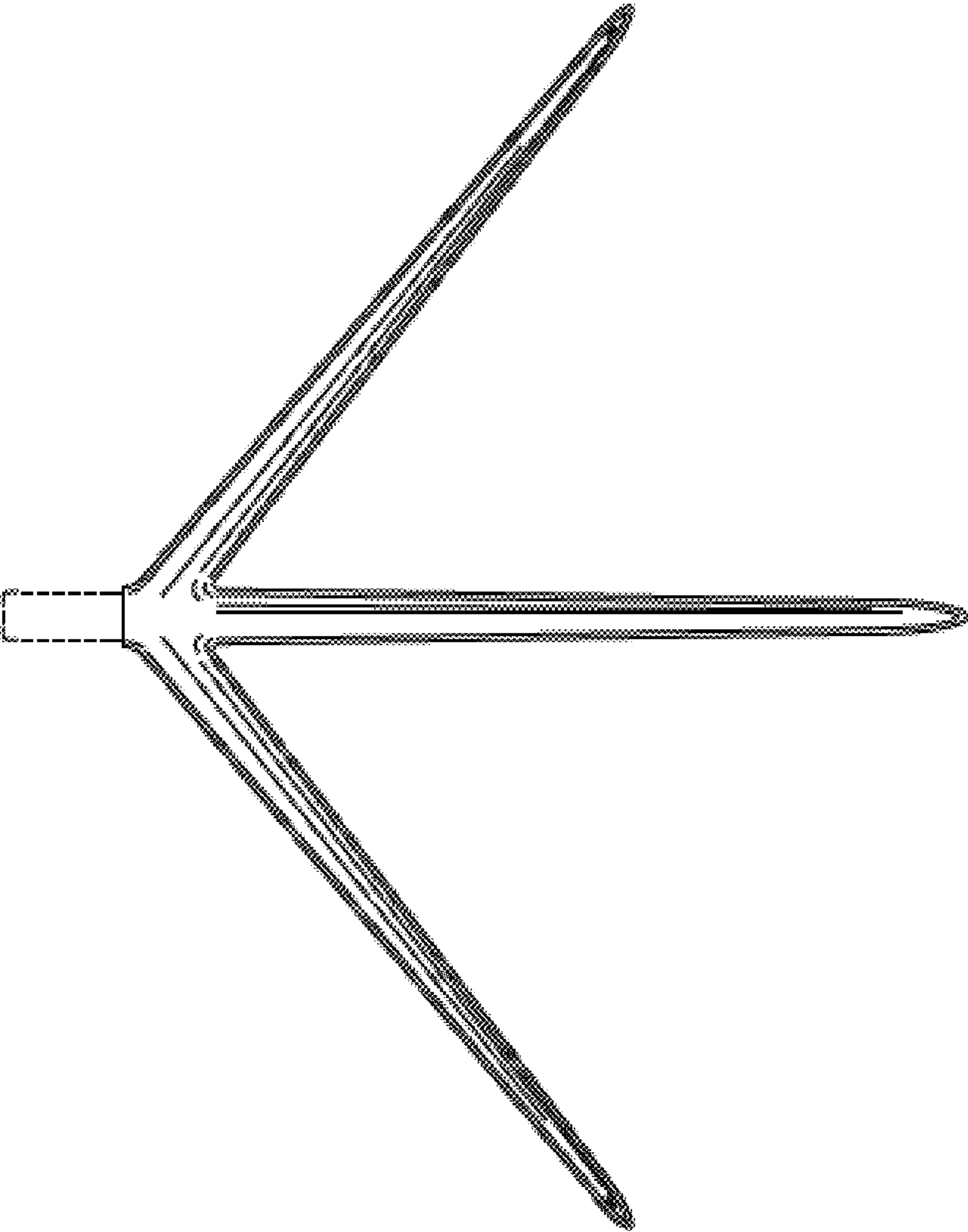

FIGURE 4

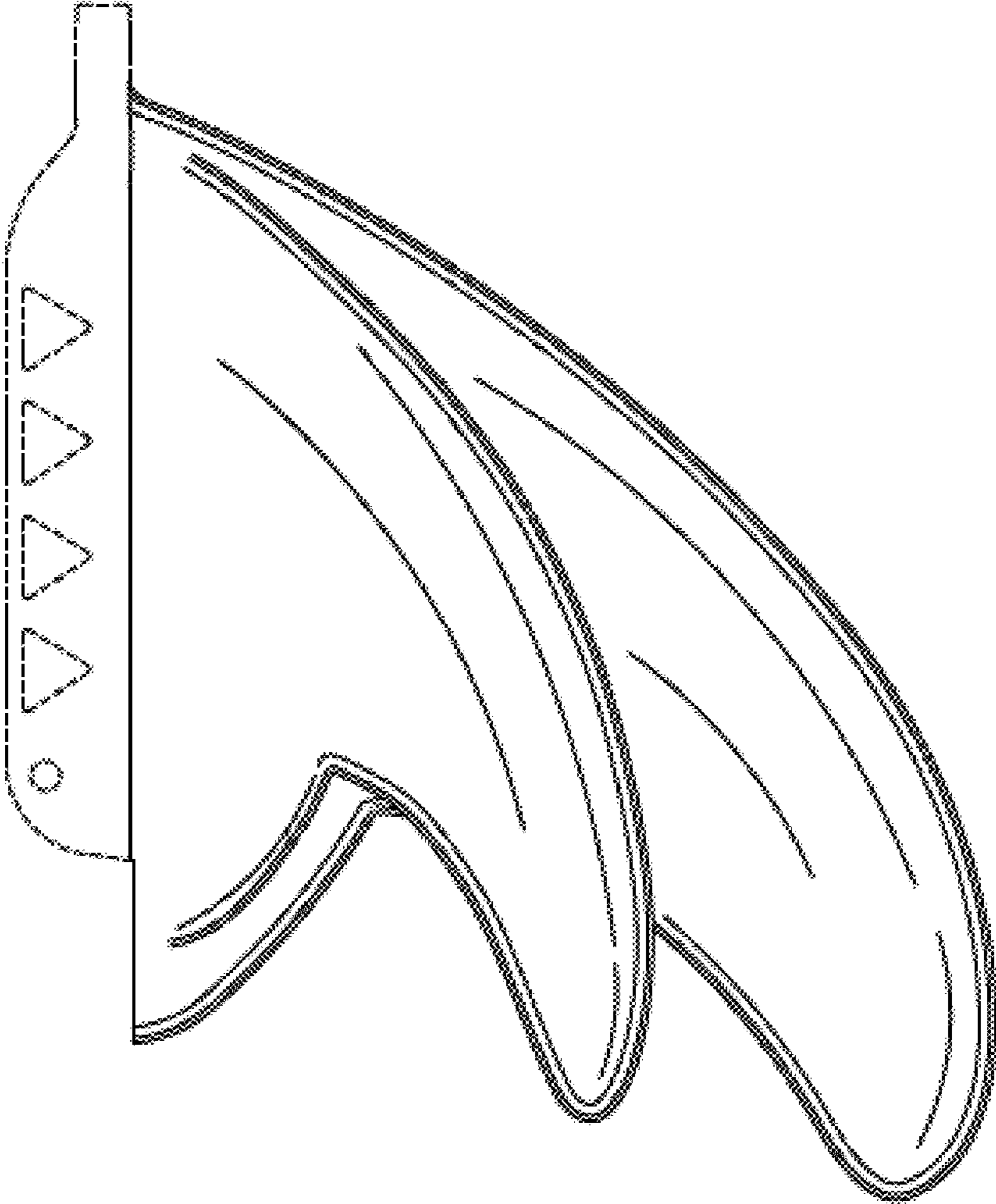

FIGURE 5

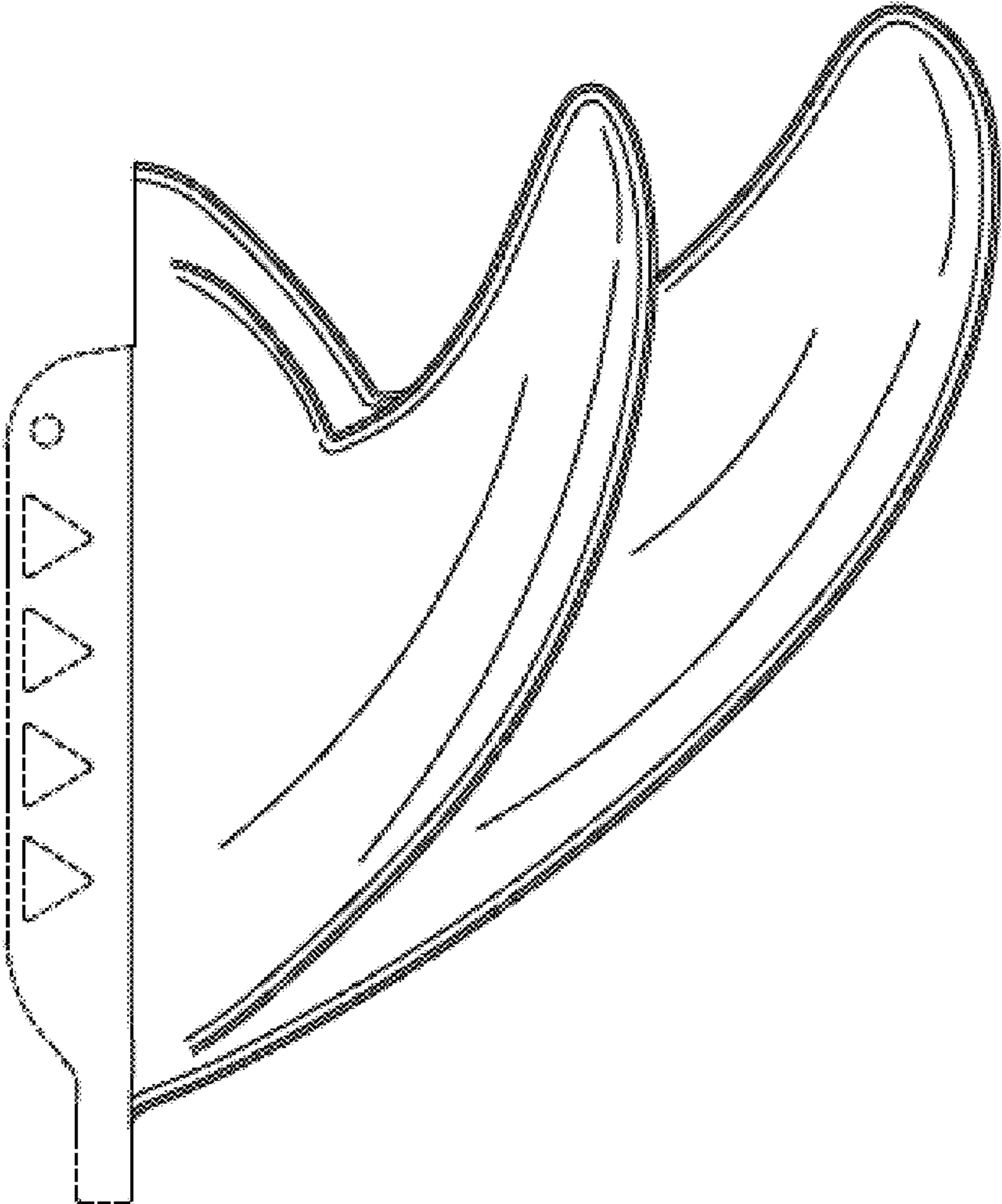

FIGURE 6

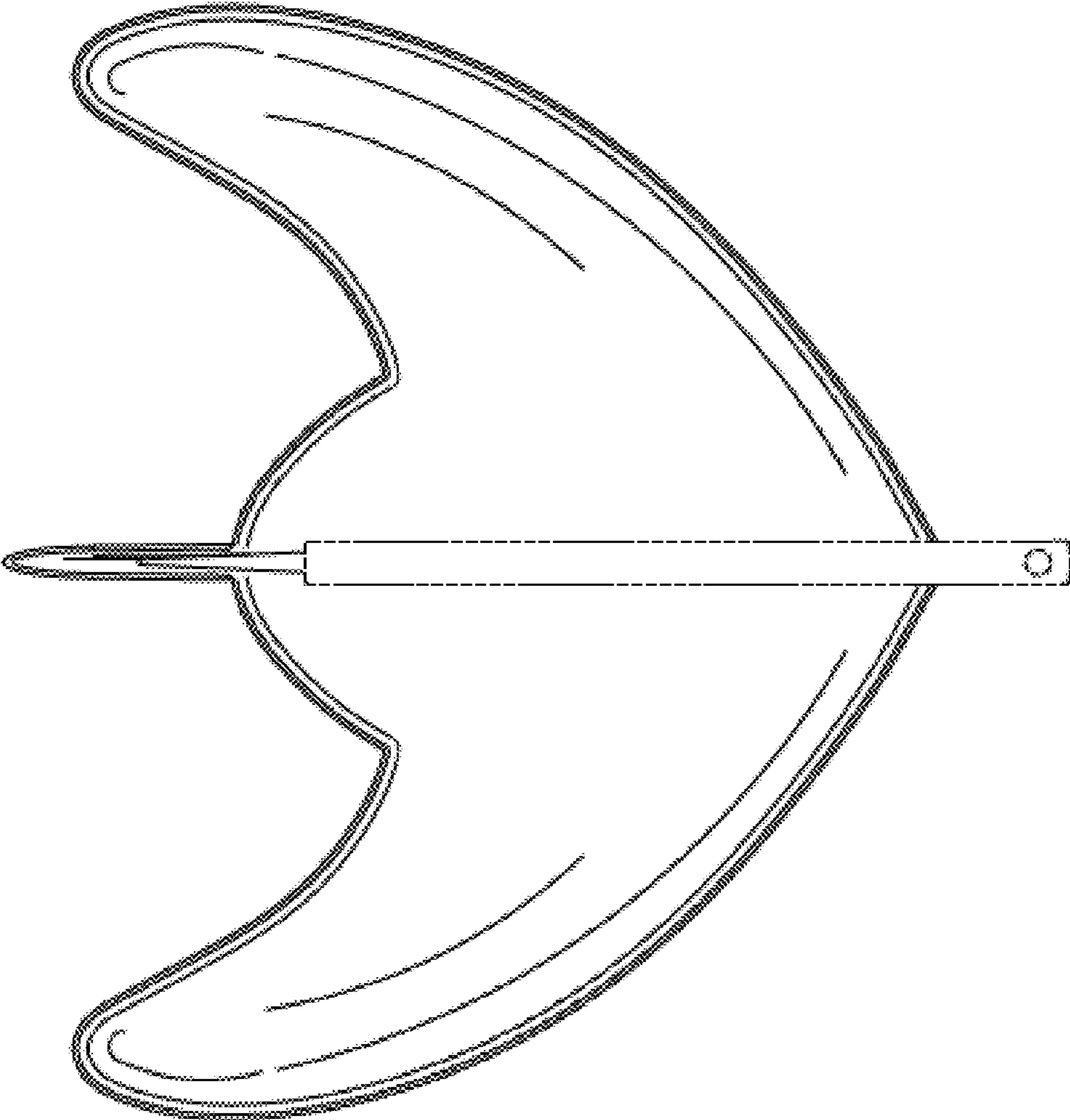

FIGURE 7

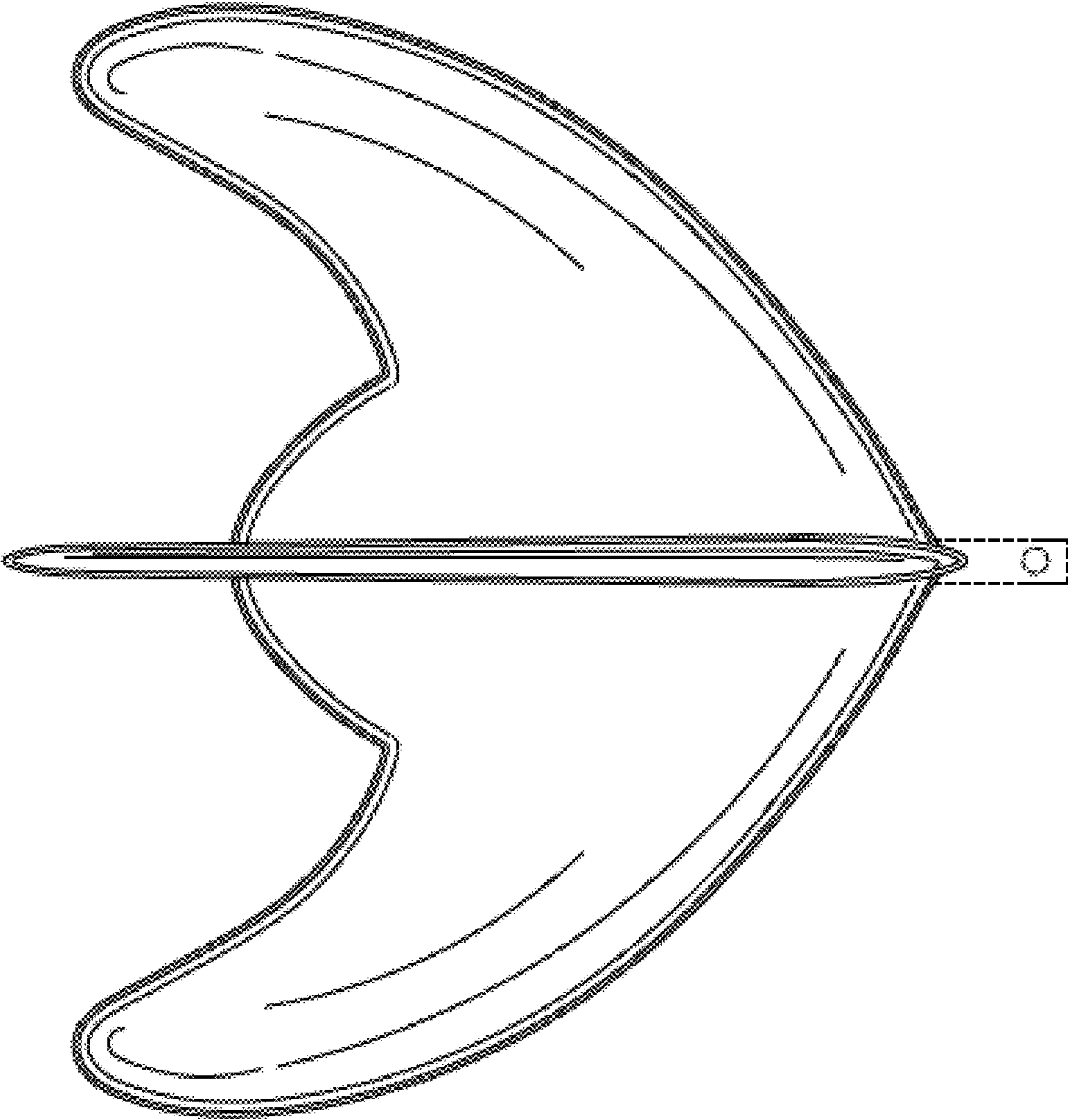

FIGURE 8

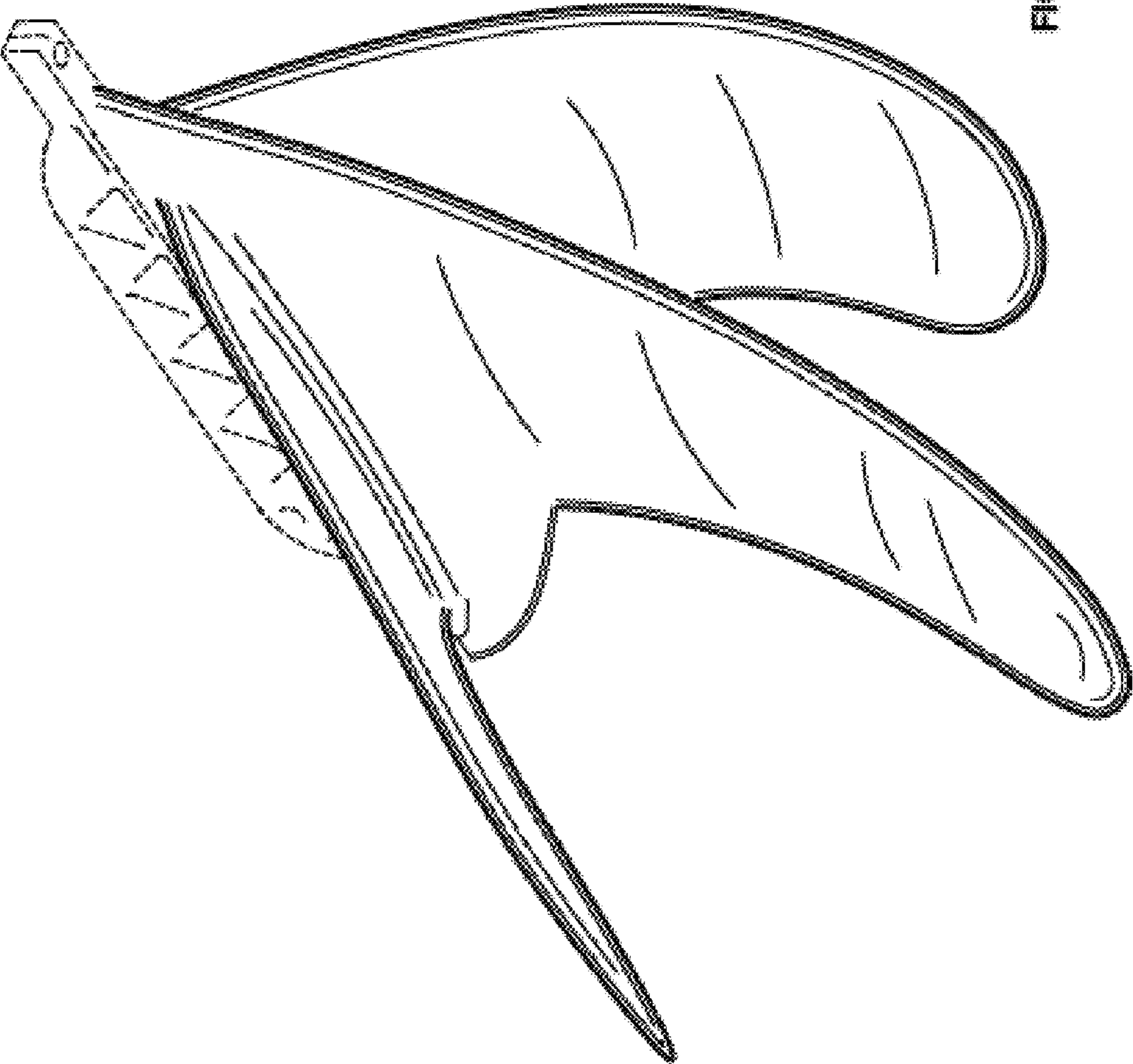

FIGURE 9

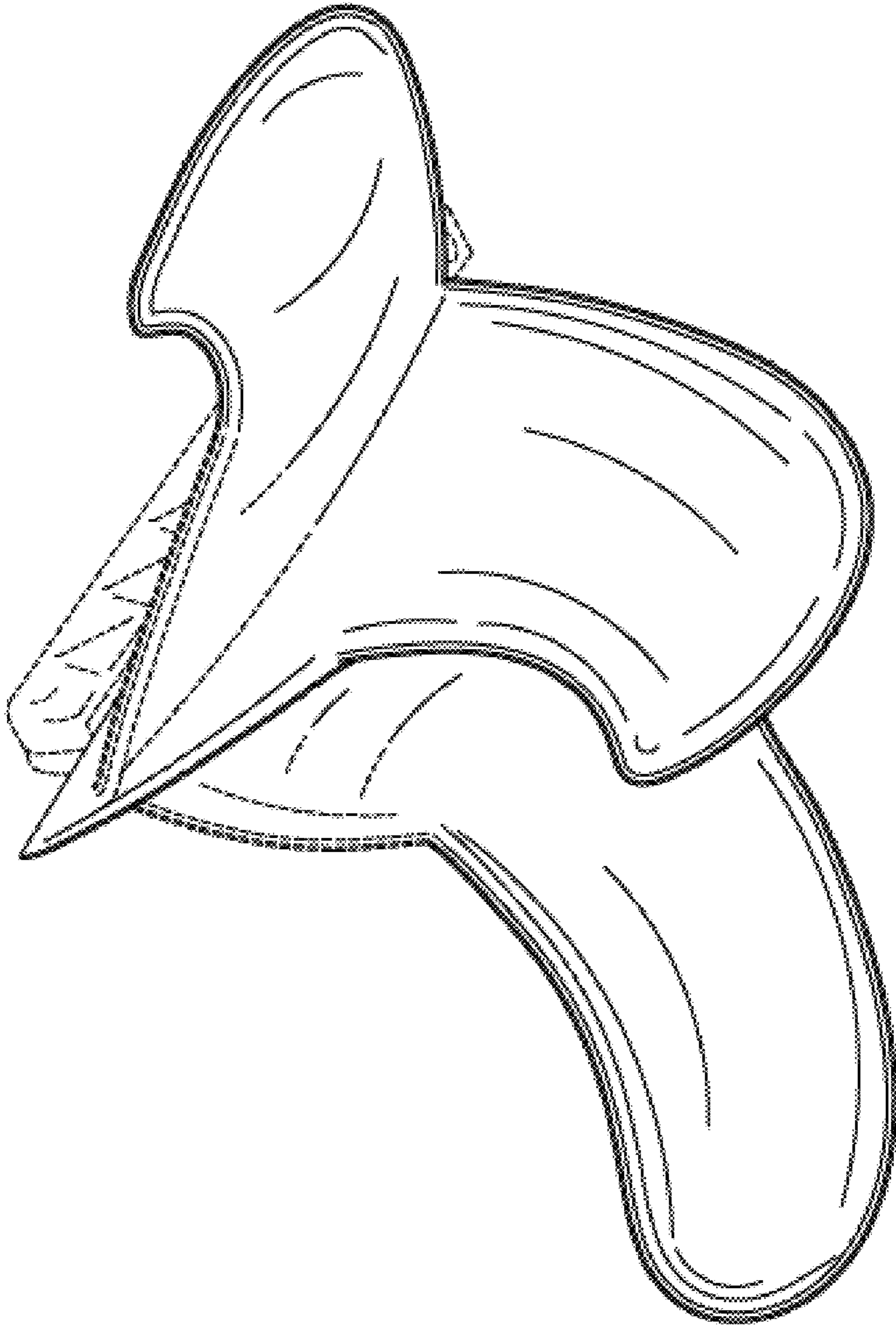

FIGURE 10

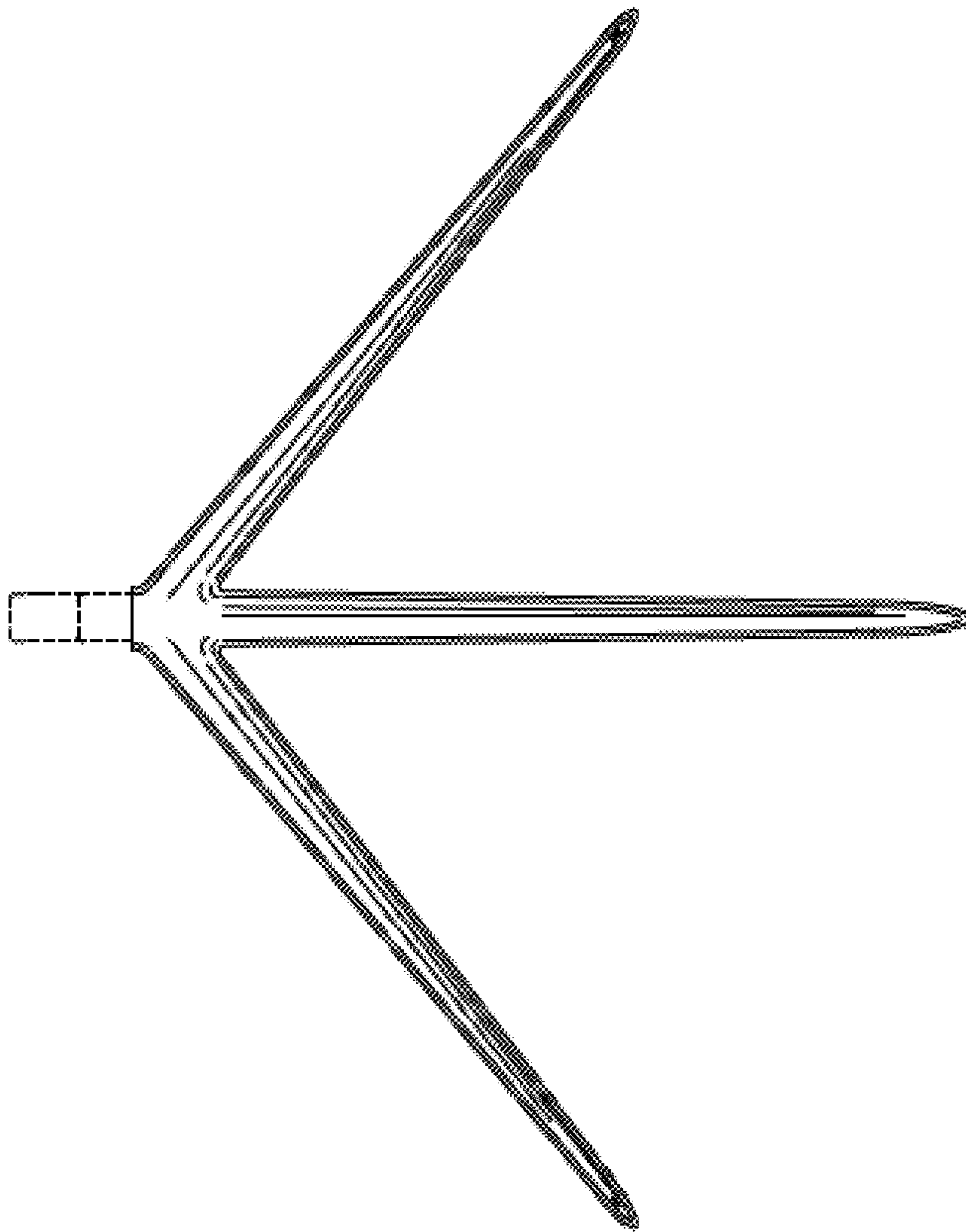

FIGURE 11

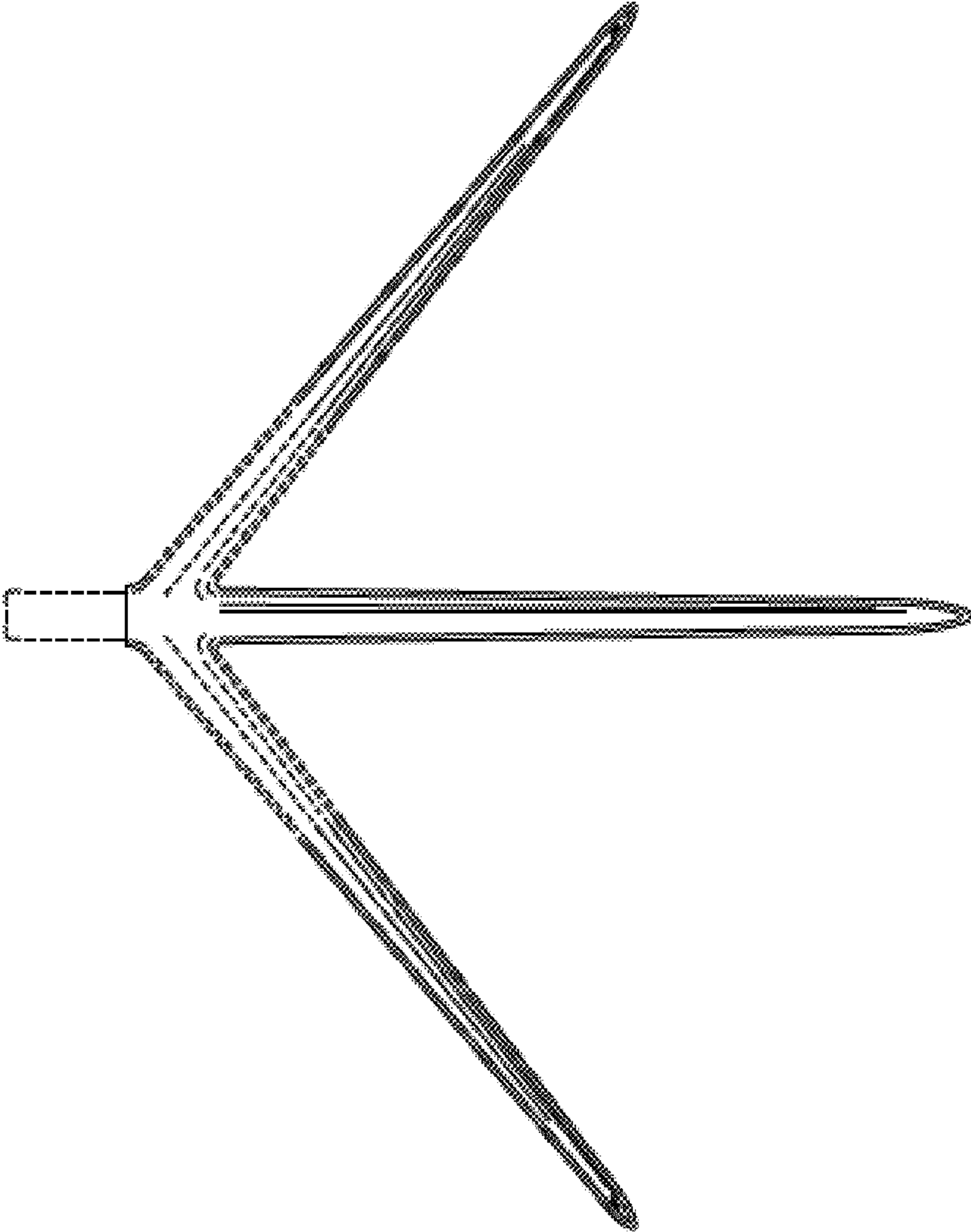

FIGURE 12

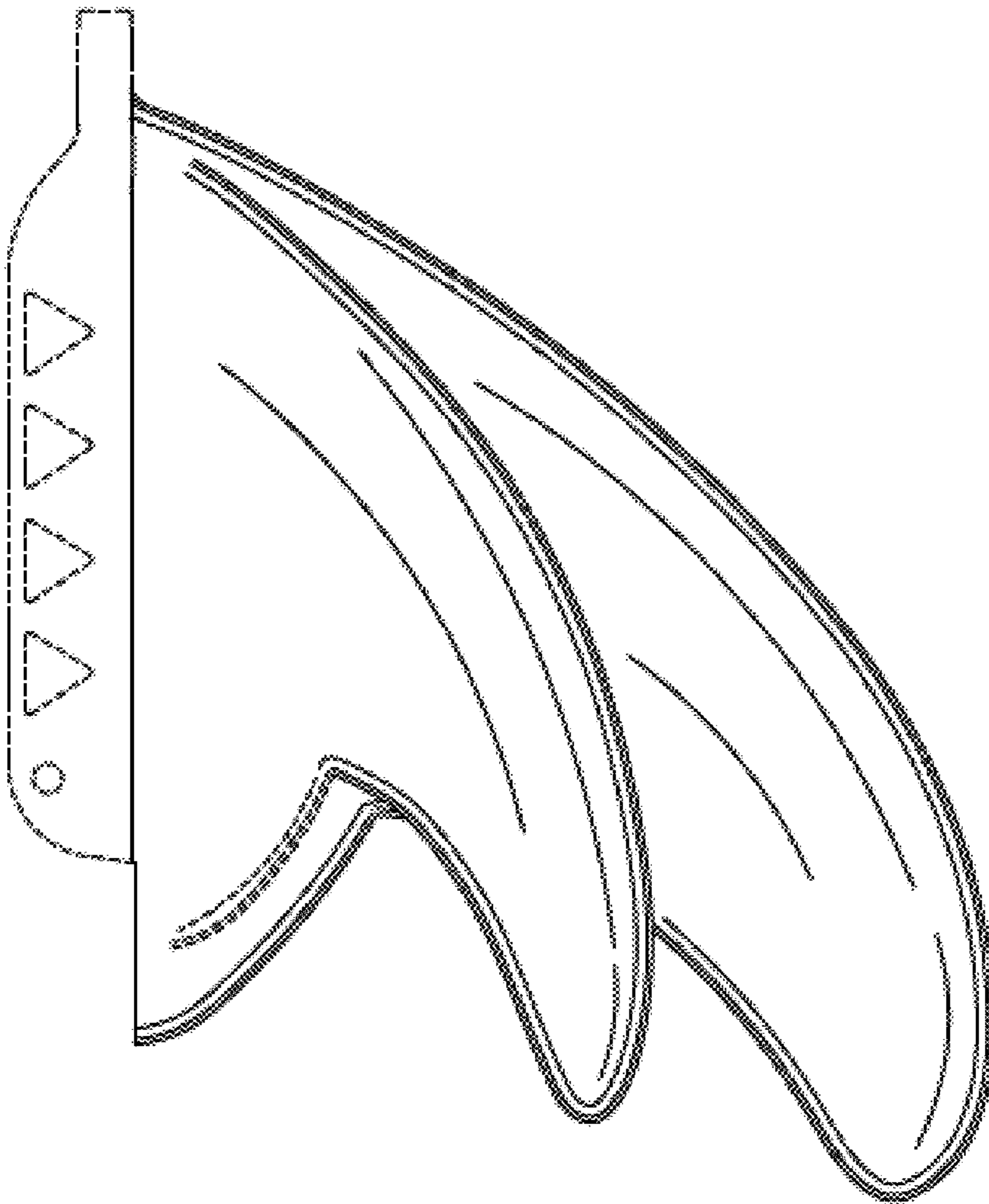

FIGURE 13

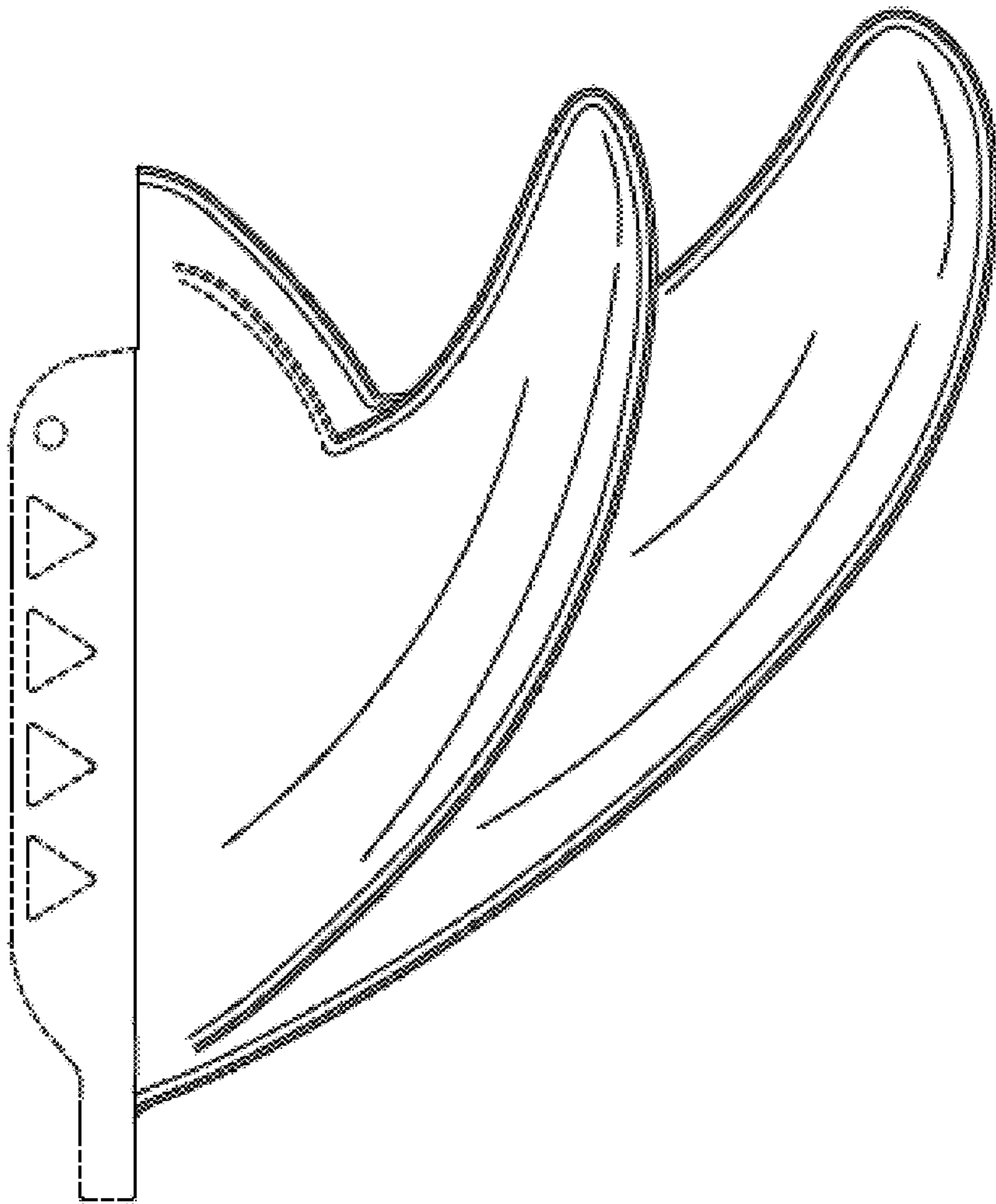

FIGURE 14

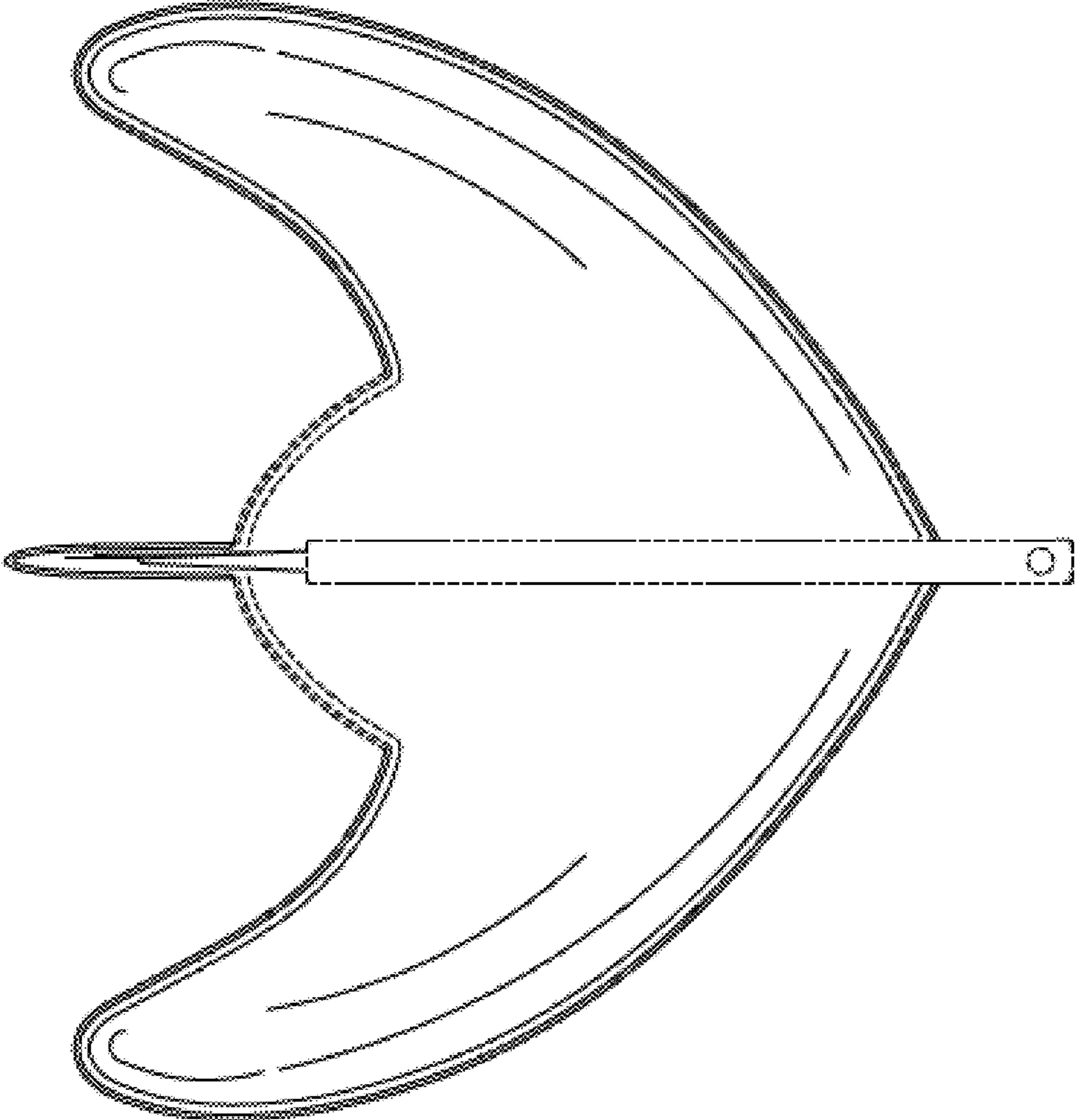

FIGURE 15

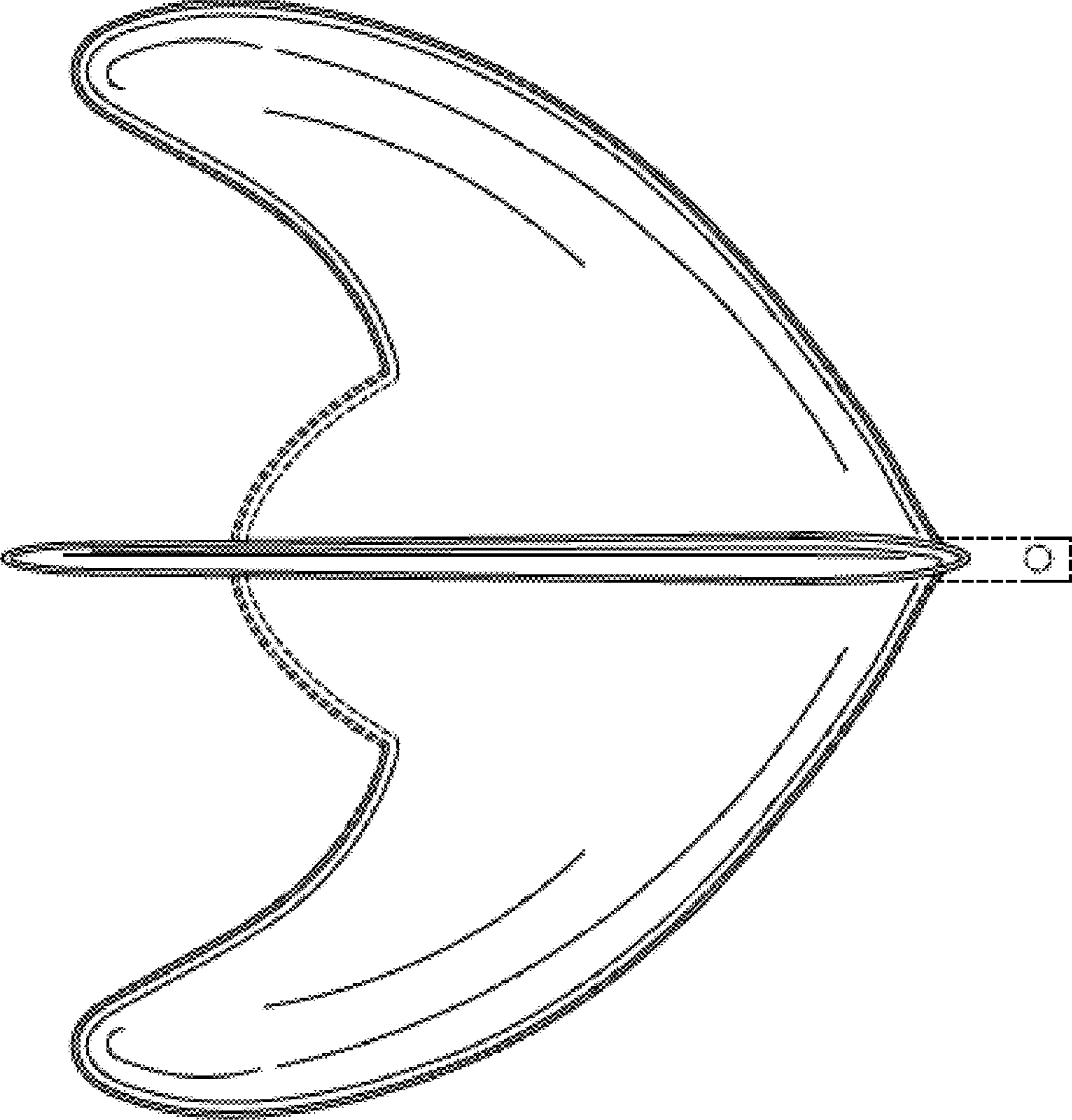

FIGURE 16

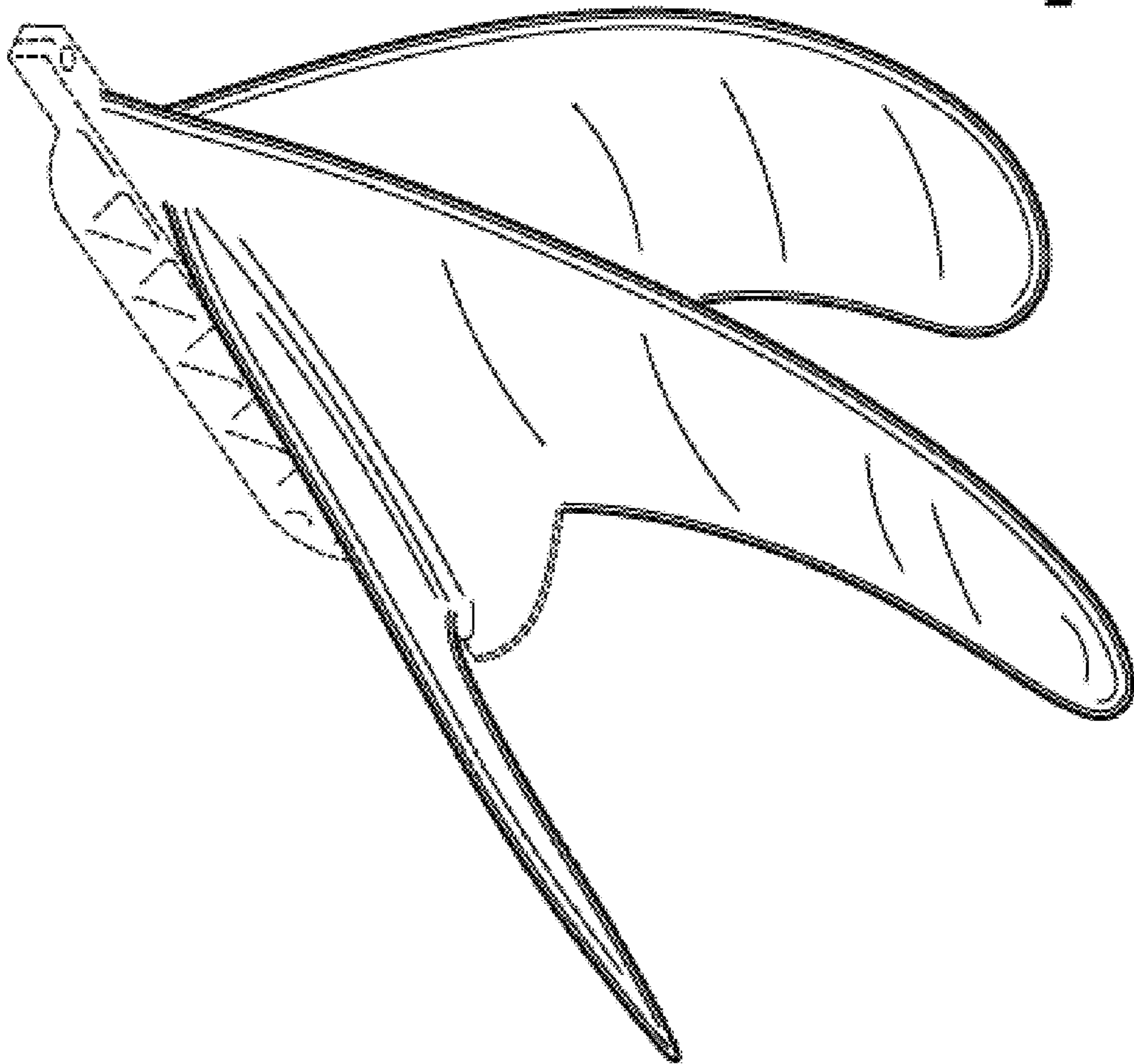

FIGURE 17

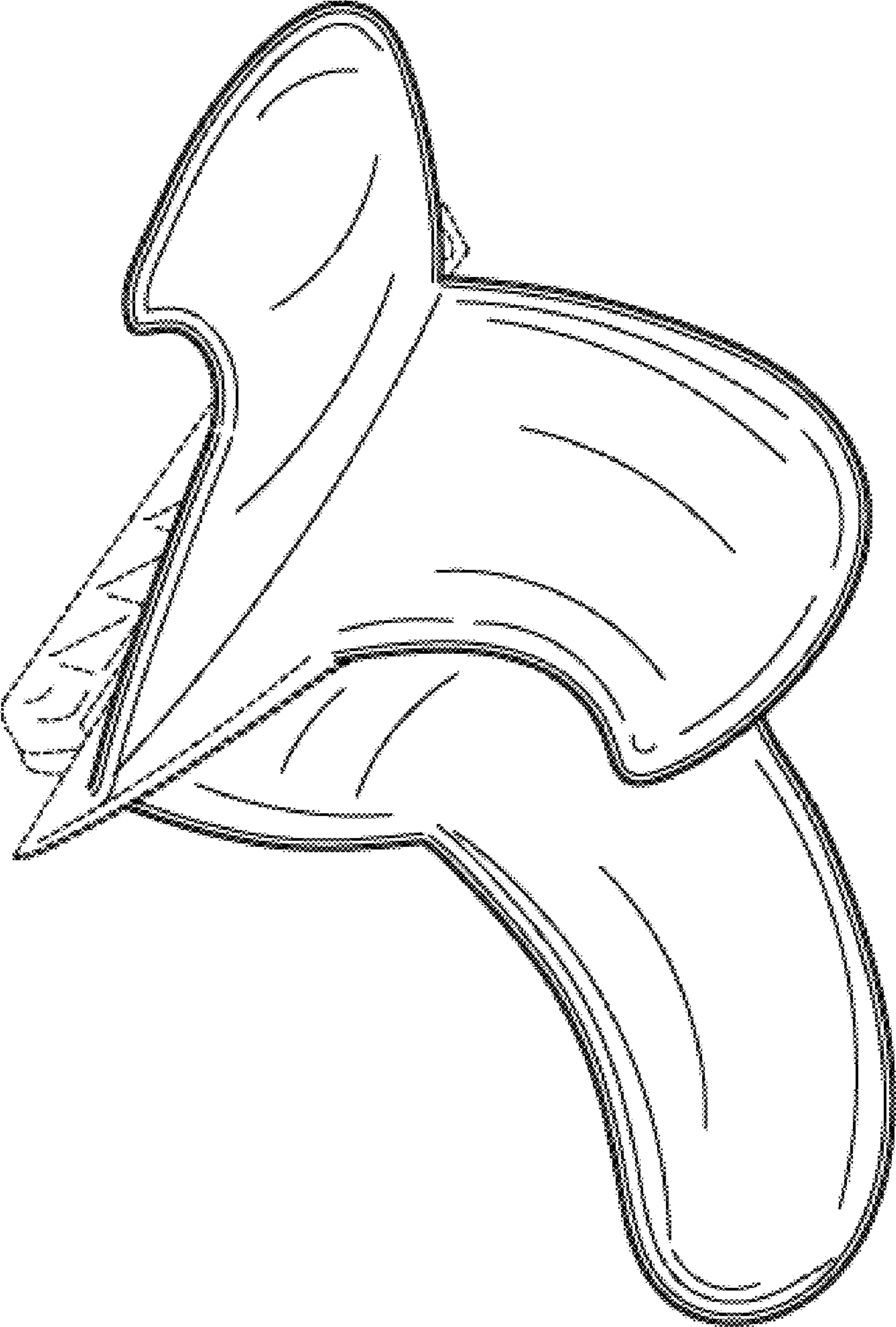

FIGURE 10

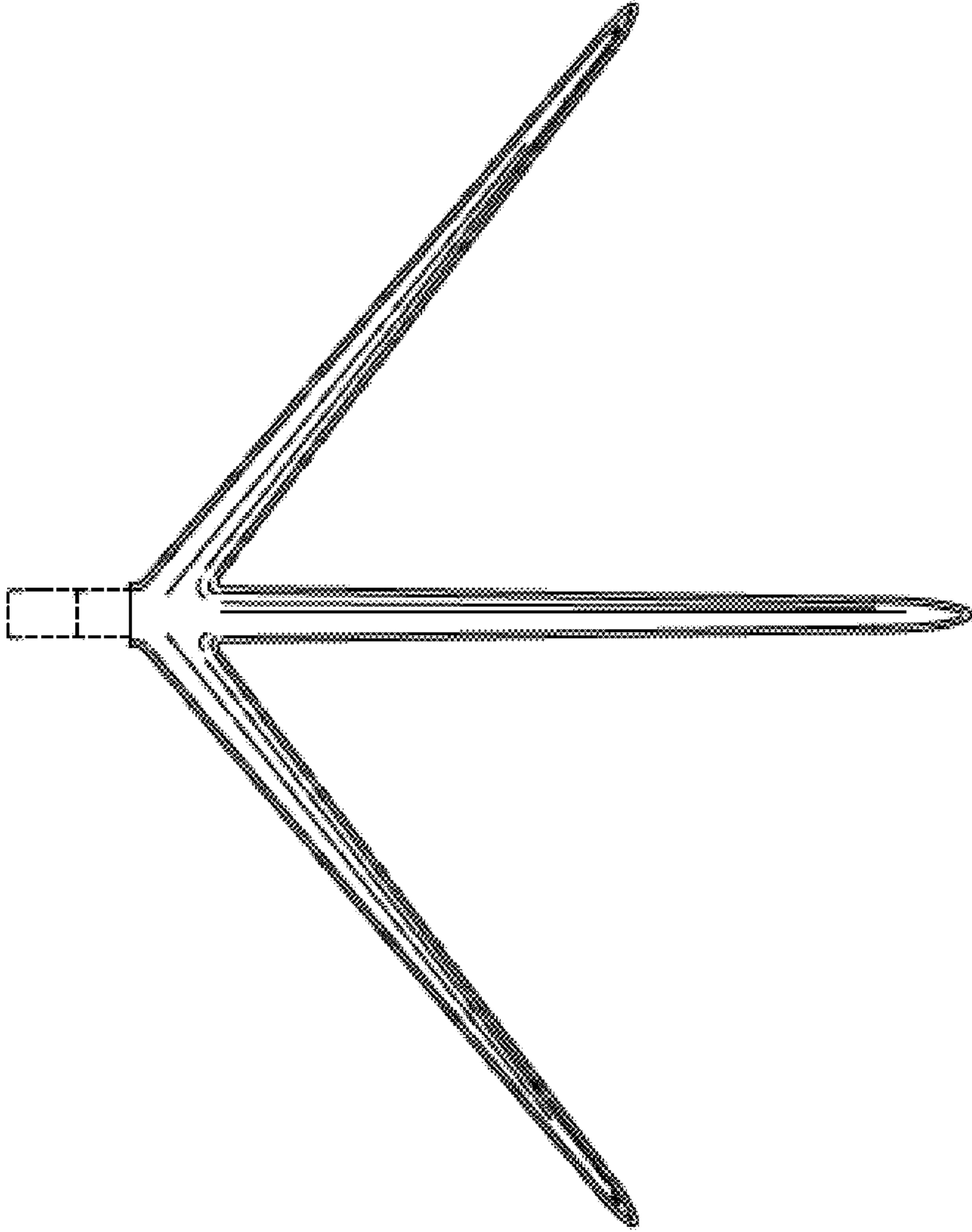

FIGURE 19

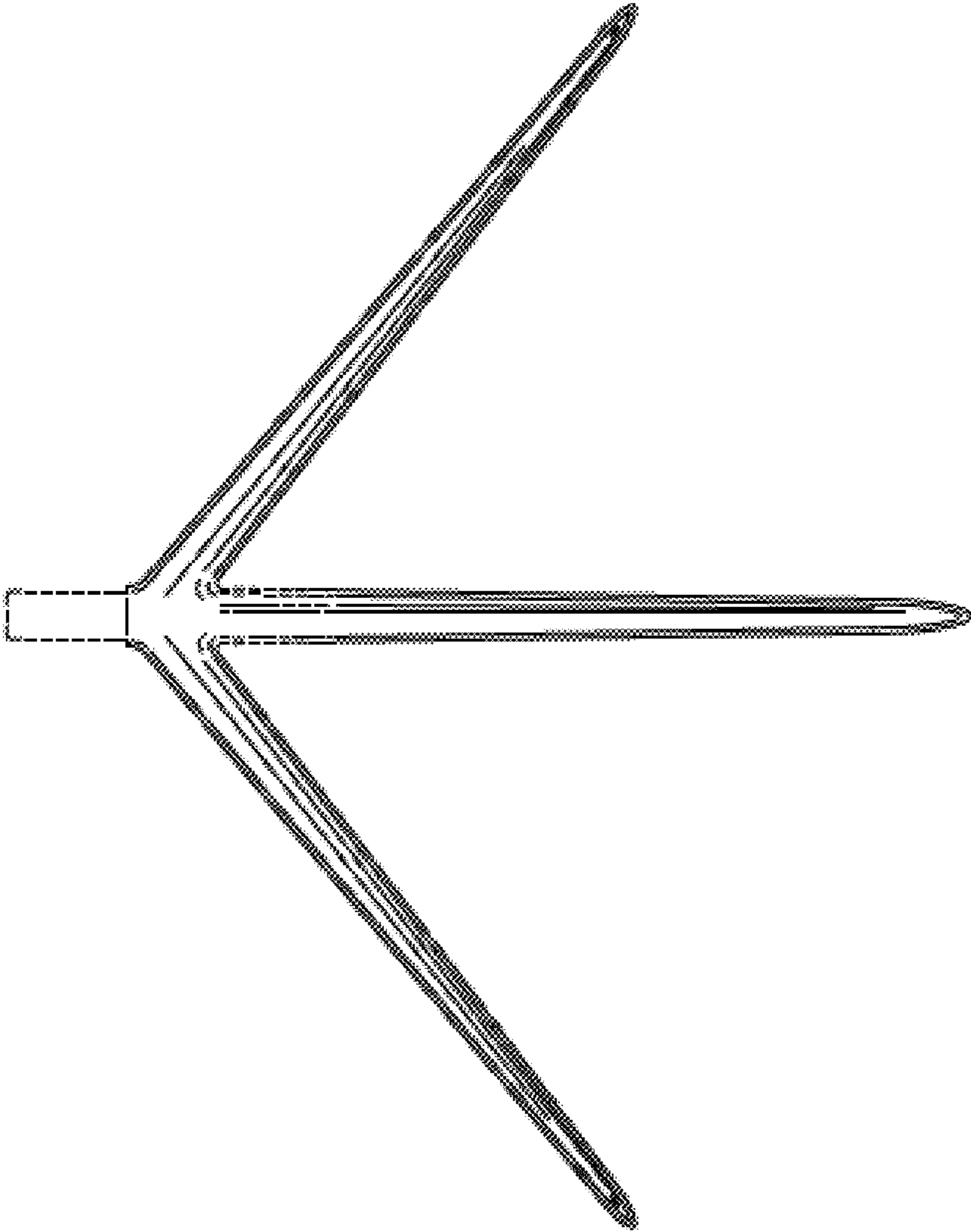

FIGURE 20

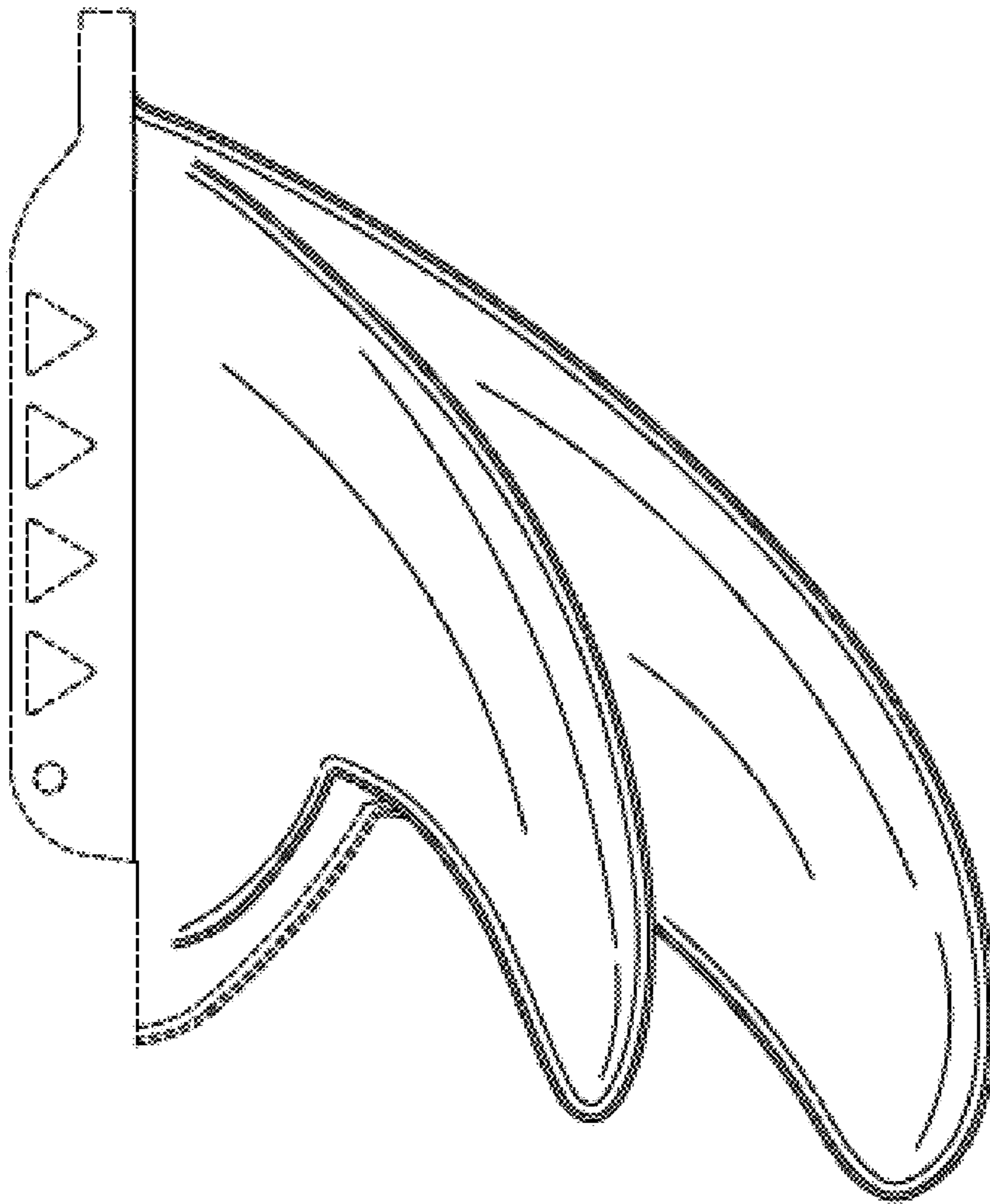

FIGURE 21

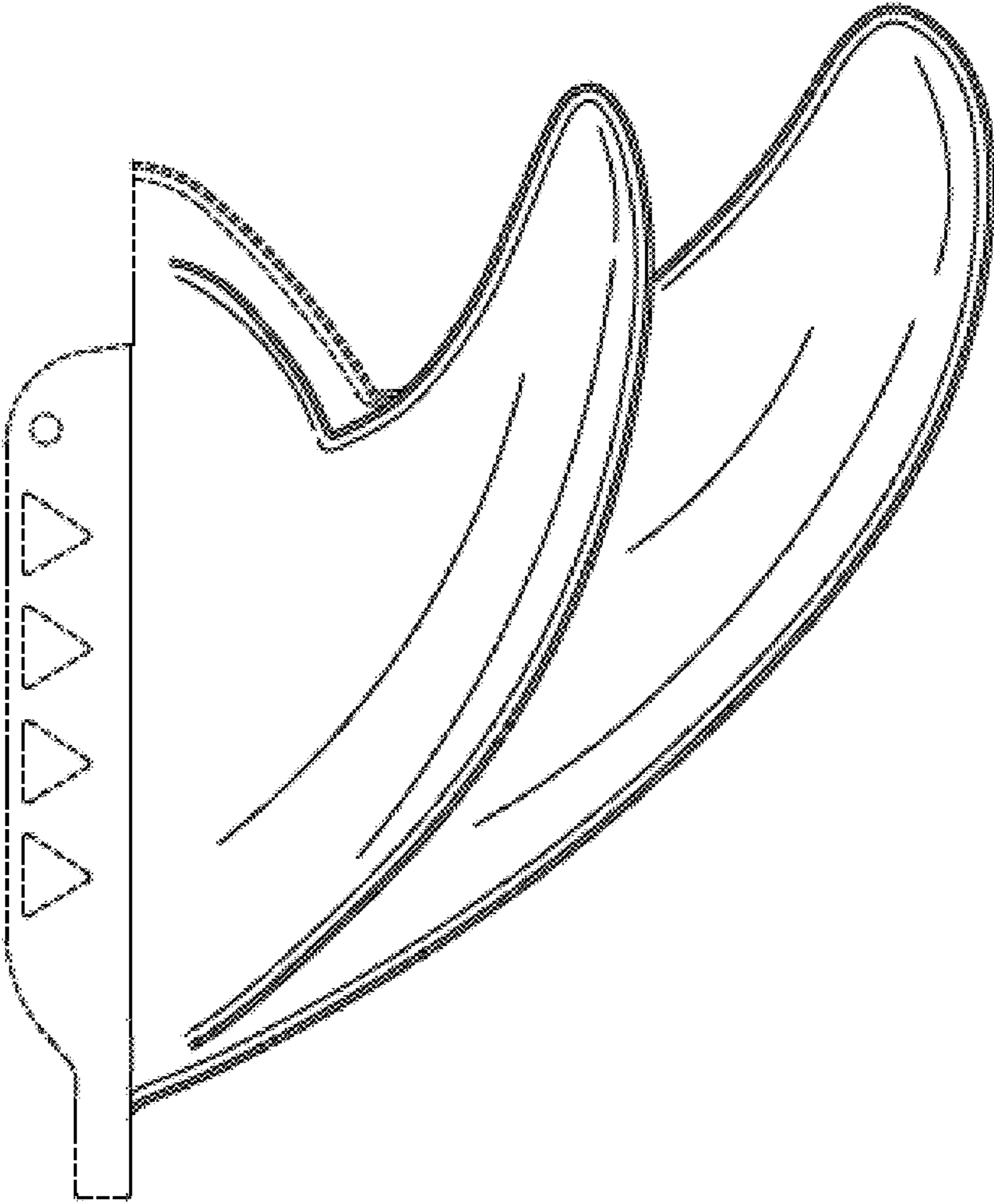

FIGURE 22

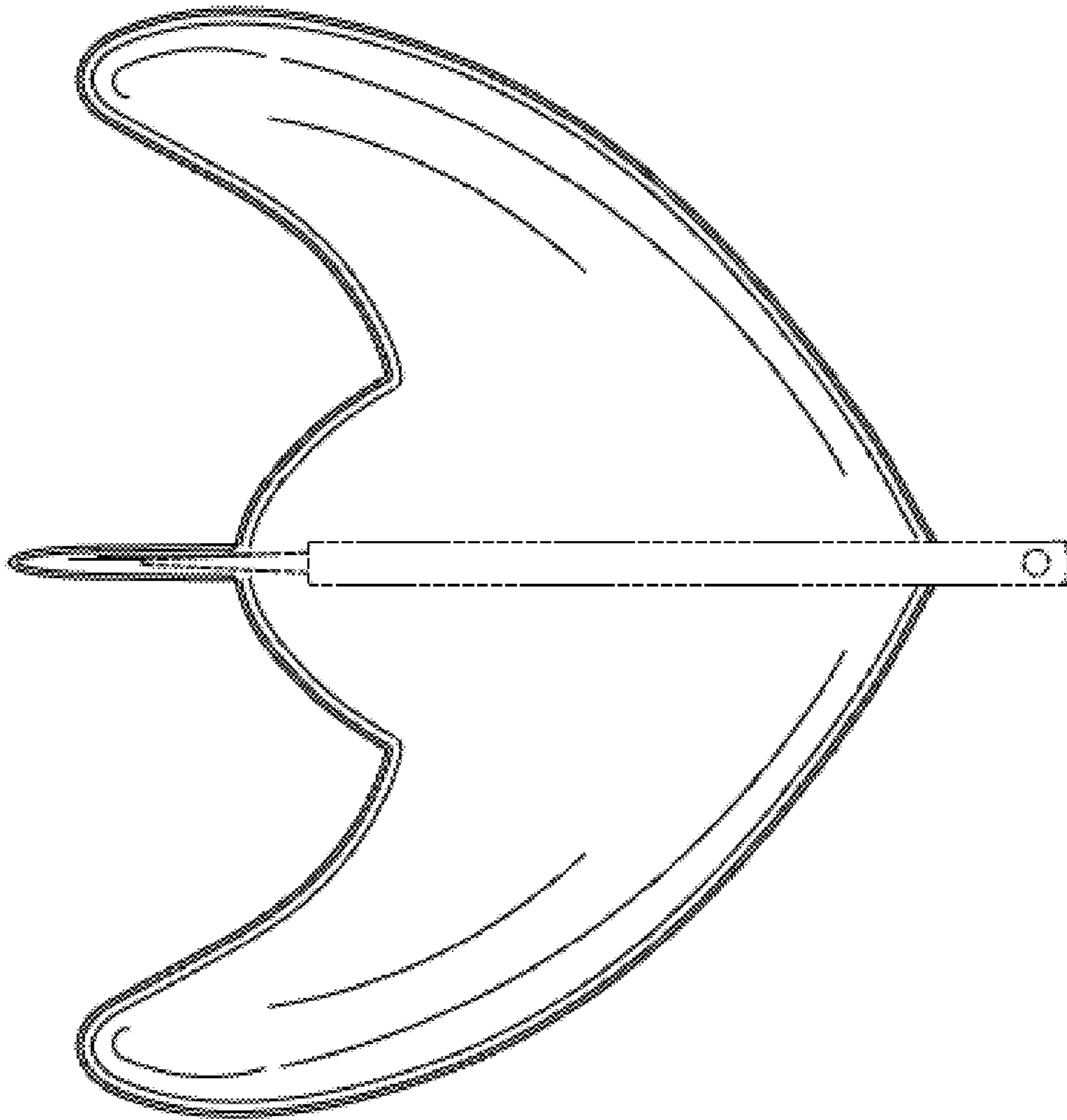

FIGURE 23

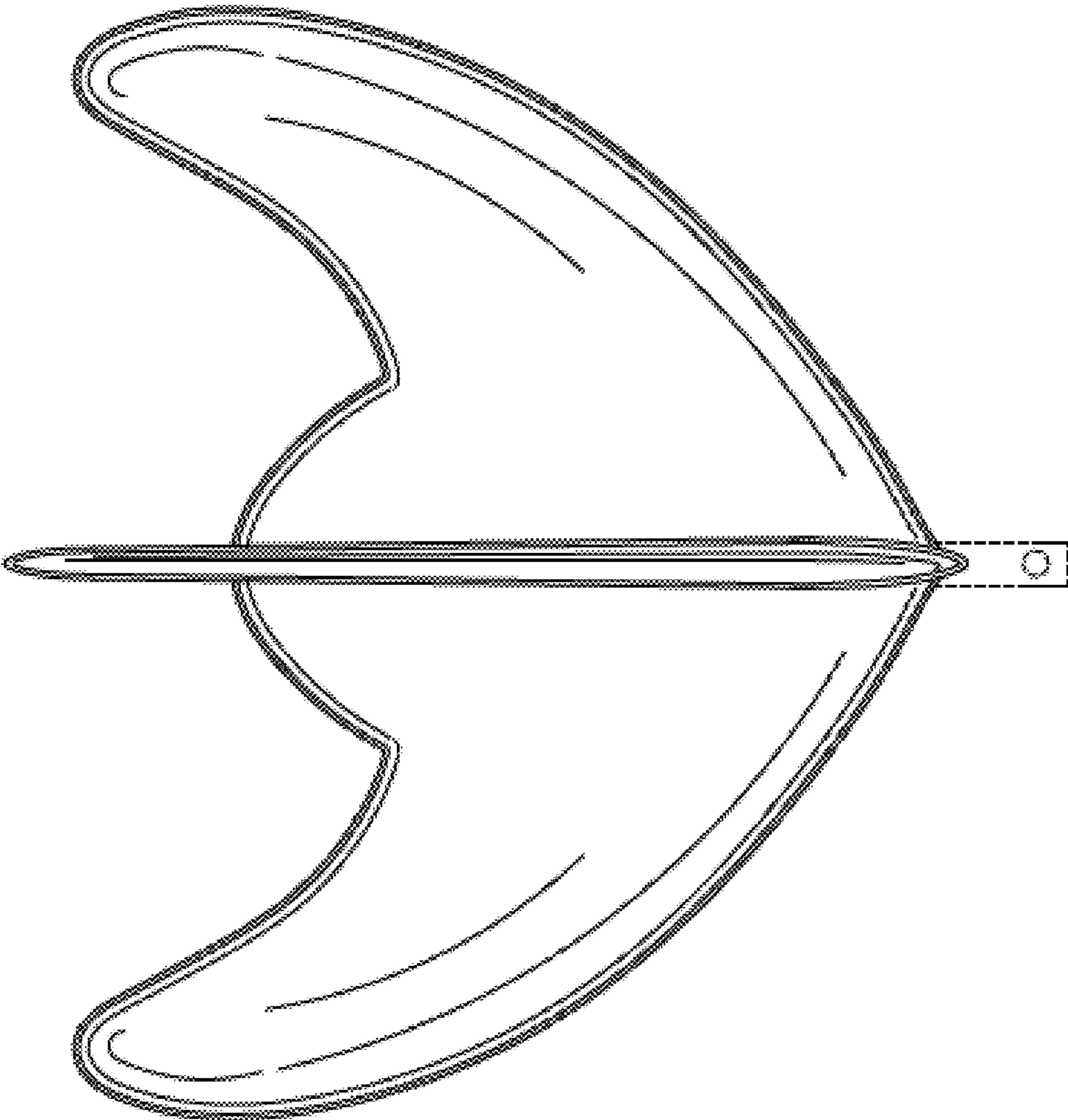

FIGURE 24