



US00D746388S

(12) **United States Design Patent**
Hockridge

(10) **Patent No.:** **US D746,388 S**

(45) **Date of Patent:** **** *Dec. 29, 2015**

(54) **EXERCISE MACHINE**

(71) Applicant: **Hoist Fitness Systems, Inc.**, Poway, CA (US)

(72) Inventor: **Bruce Hockridge**, San Diego, CA (US)

(73) Assignee: **Hoist Fitness Systems, Inc.**, Poway, CA (US)

(*) Notice: This patent is subject to a terminal disclaimer.

(**) Term: **14 Years**

(21) Appl. No.: **29/500,757**

(22) Filed: **Aug. 28, 2014**

(51) **LOC (10) Cl.** **21-02**

(52) **U.S. Cl.**
USPC **D21/673**

(58) **Field of Classification Search**
USPC 482/99, 111, 114, 121, 133, 94, 142, 482/130, 112, 100, 138, 102, 101, 1, 5, 8, 9, 482/901, 95, 96, 51, 92, 93, 136, 104, 108, 482/97, 140, 69, 107, 98, 139, 4, 6, 145, 482/41; 434/29; D21/673, 691, 694, 682, D21/686, 675, 676, 826
See application file for complete search history.

(56) **References Cited**

U.S. PATENT DOCUMENTS

| | | | | | |
|-----------|------|---------|------------------|-------|---------|
| D428,949 | S * | 8/2000 | Simonson | | D21/694 |
| 6,447,430 | B1 * | 9/2002 | Webb et al. | | 482/98 |
| 6,537,182 | B2 * | 3/2003 | Slawinski et al. | | 482/104 |
| D512,471 | S * | 12/2005 | Panatta | | D21/673 |
| 7,112,162 | B2 * | 9/2006 | Greenland | | 482/94 |
| D590,032 | S * | 4/2009 | Webber et al. | | D21/673 |

| | | | | | |
|--------------|------|---------|------------------|-------|---------|
| D599,418 | S * | 9/2009 | Fenster et al. | | D21/675 |
| 7,722,509 | B2 * | 5/2010 | Eder | | 482/99 |
| 7,955,235 | B2 * | 6/2011 | Keiser | | 482/112 |
| 8,506,459 | B2 * | 8/2013 | Cassidy et al. | | 482/94 |
| 8,708,872 | B2 * | 4/2014 | Giannelli et al. | | 482/102 |
| D708,274 | S * | 7/2014 | Eder | | D21/673 |
| 2007/0037674 | A1 * | 2/2007 | Finn et al. | | 482/97 |
| 2011/0183816 | A1 * | 7/2011 | Giannelli et al. | | 482/94 |
| 2013/0274075 | A1 * | 10/2013 | Habing et al. | | 482/102 |
| 2014/0296040 | A1 * | 10/2014 | Mobley | | 482/104 |

* cited by examiner

Primary Examiner — Robert M Spear

Assistant Examiner — Ryan Harvey

(74) *Attorney, Agent, or Firm* — Jones Day

(57) **CLAIM**

The ornamental design for an exercise machine, as shown and described in the accompanying figures.

DESCRIPTION

FIG. 1 is a front perspective view of an exercise machine; FIG. 2 is a front elevation view of an exercise machine as shown in FIG. 1; FIG. 3 is a rear elevation view of an exercise machine as shown in FIG. 1; FIG. 4 is a left side elevation view of an exercise machine as shown in FIG. 1; FIG. 5 is a right side elevation view of an exercise machine as shown in FIG. 1; FIG. 6 is a top plan view of an exercise machine as shown in FIG. 1; and, FIG. 7 is a bottom plan view of an exercise machine as shown in FIG. 1.

The broken lines in FIGS. 1 through 7 represent unclaimed environmental subject matter and form no part of the claimed design.

1 Claim, 7 Drawing Sheets

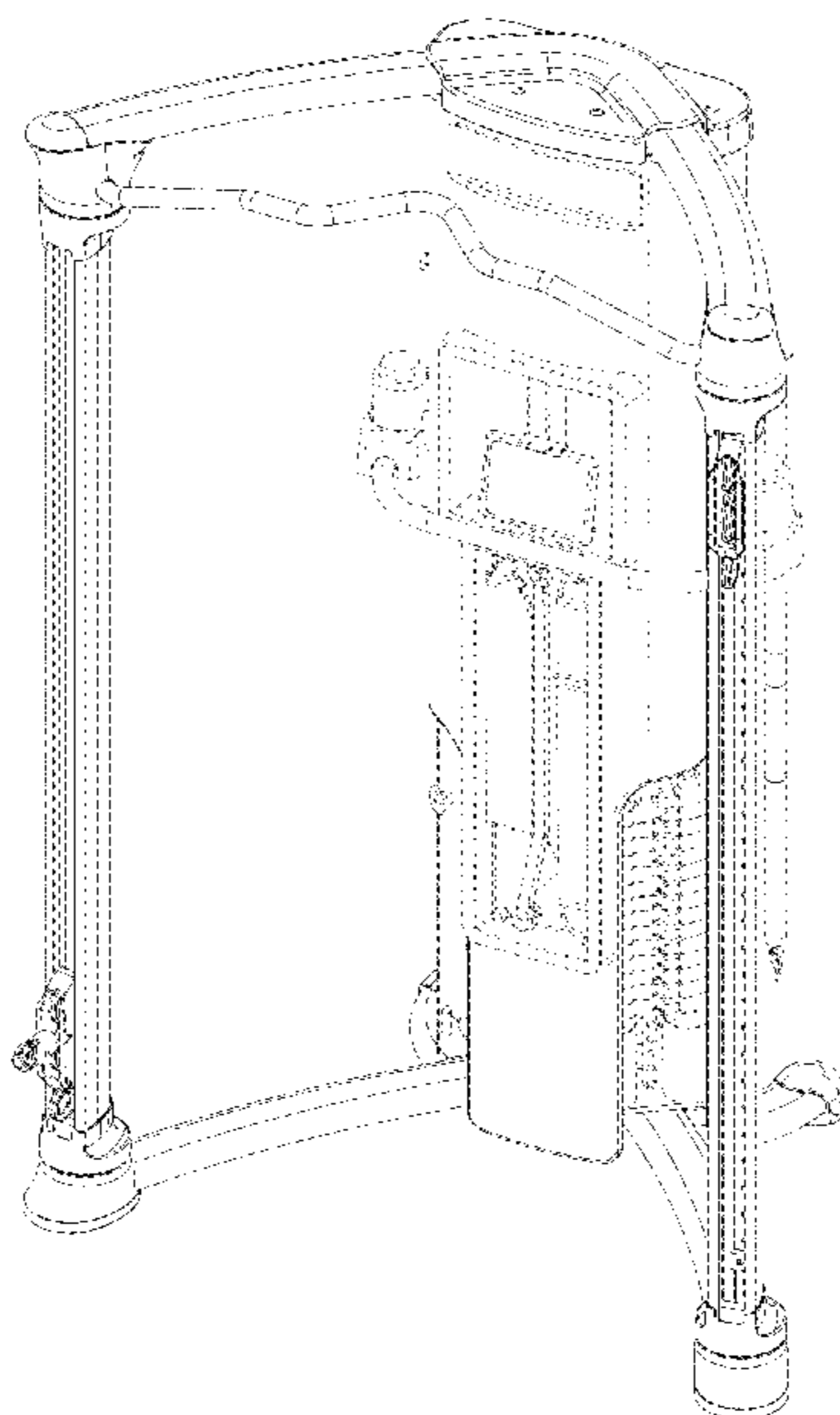

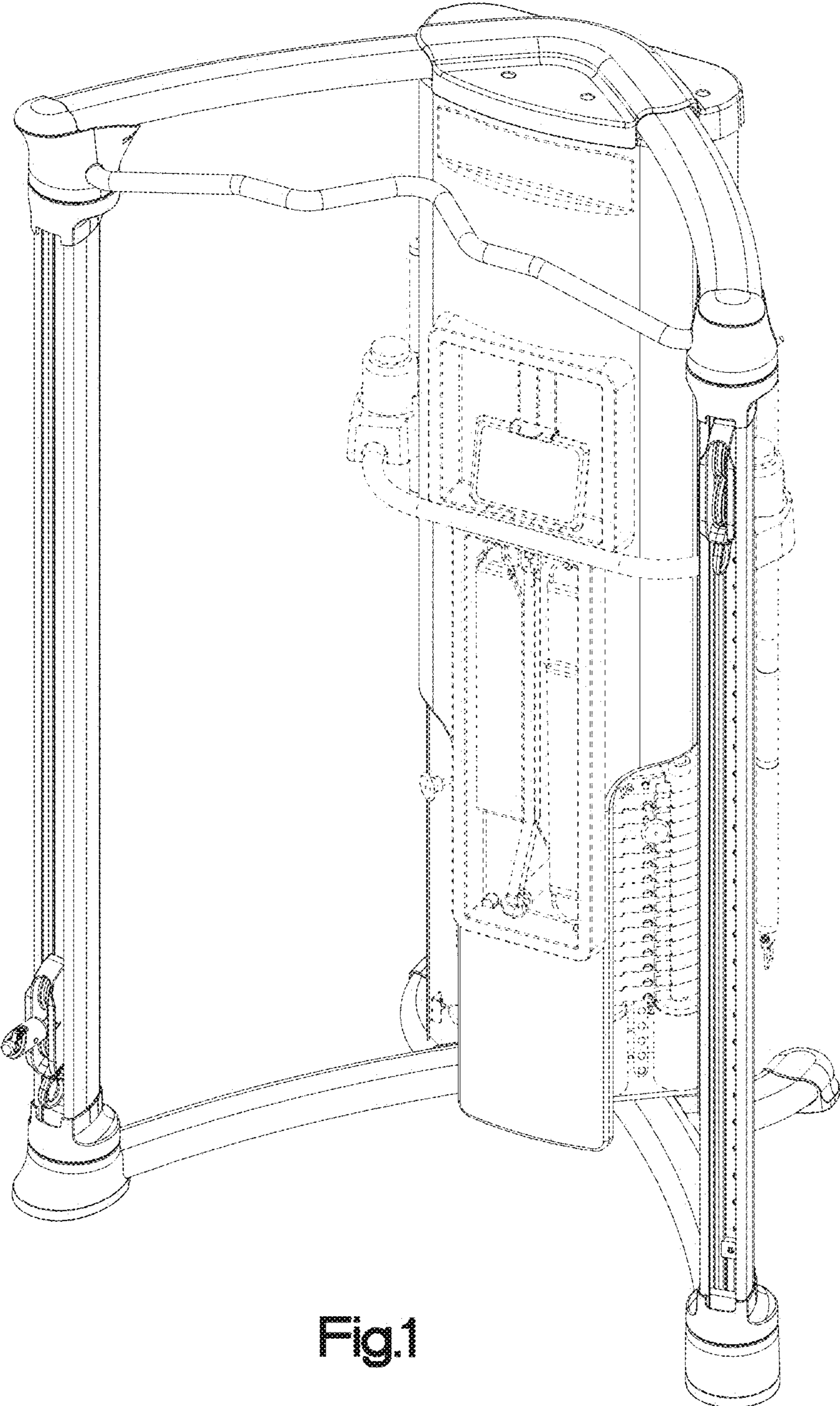

Fig.1

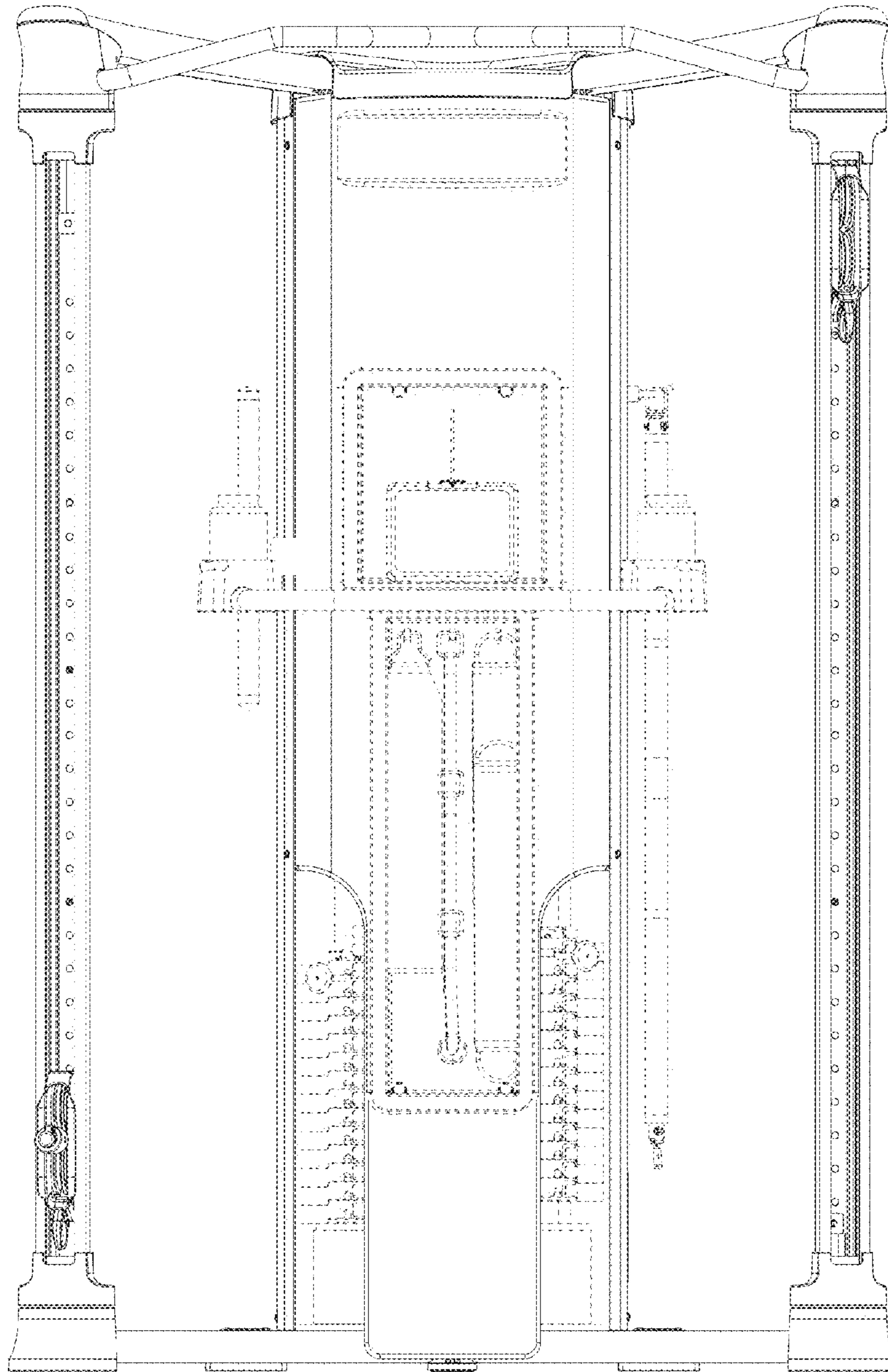

Fig.2

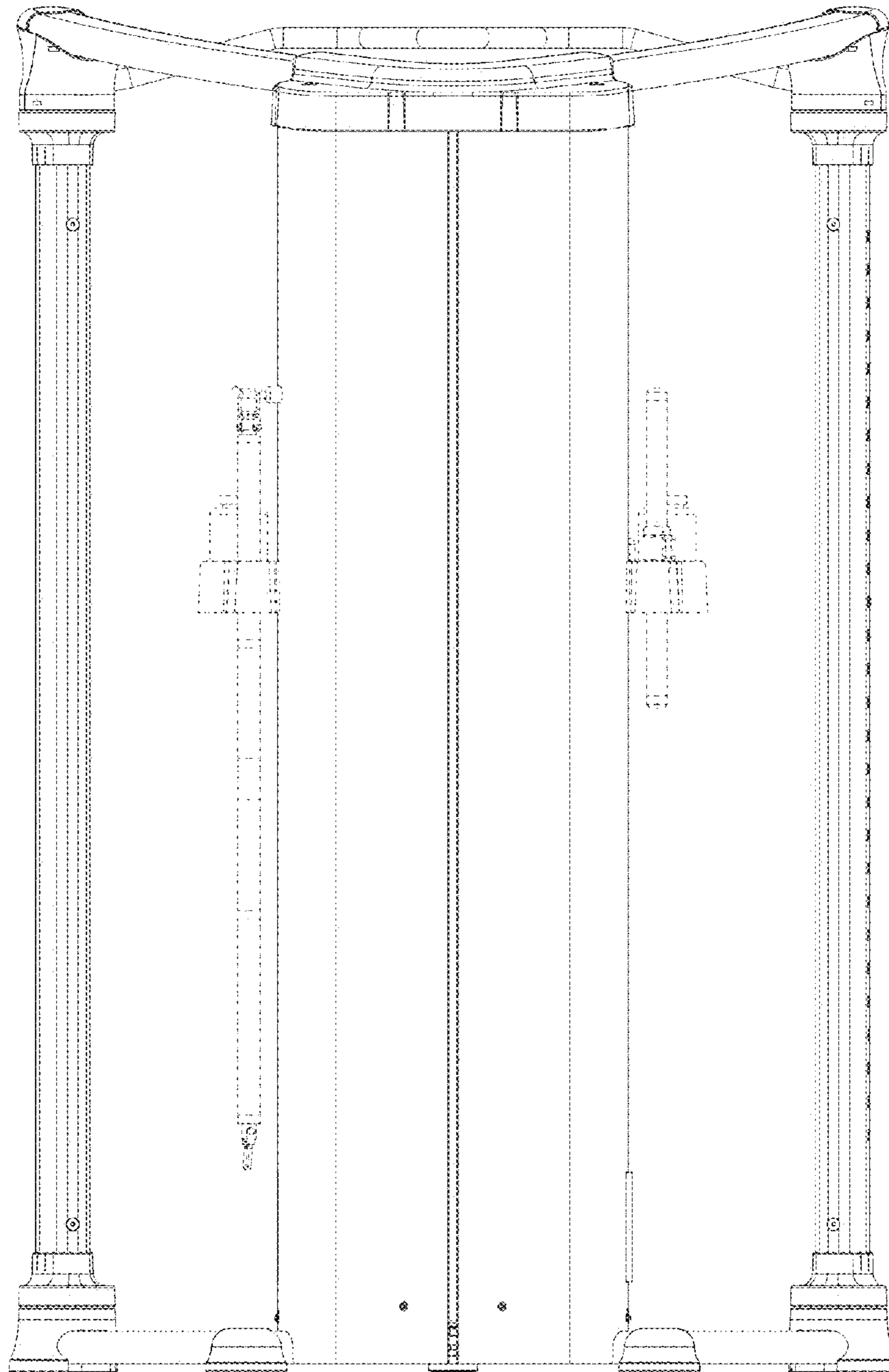

Fig.3

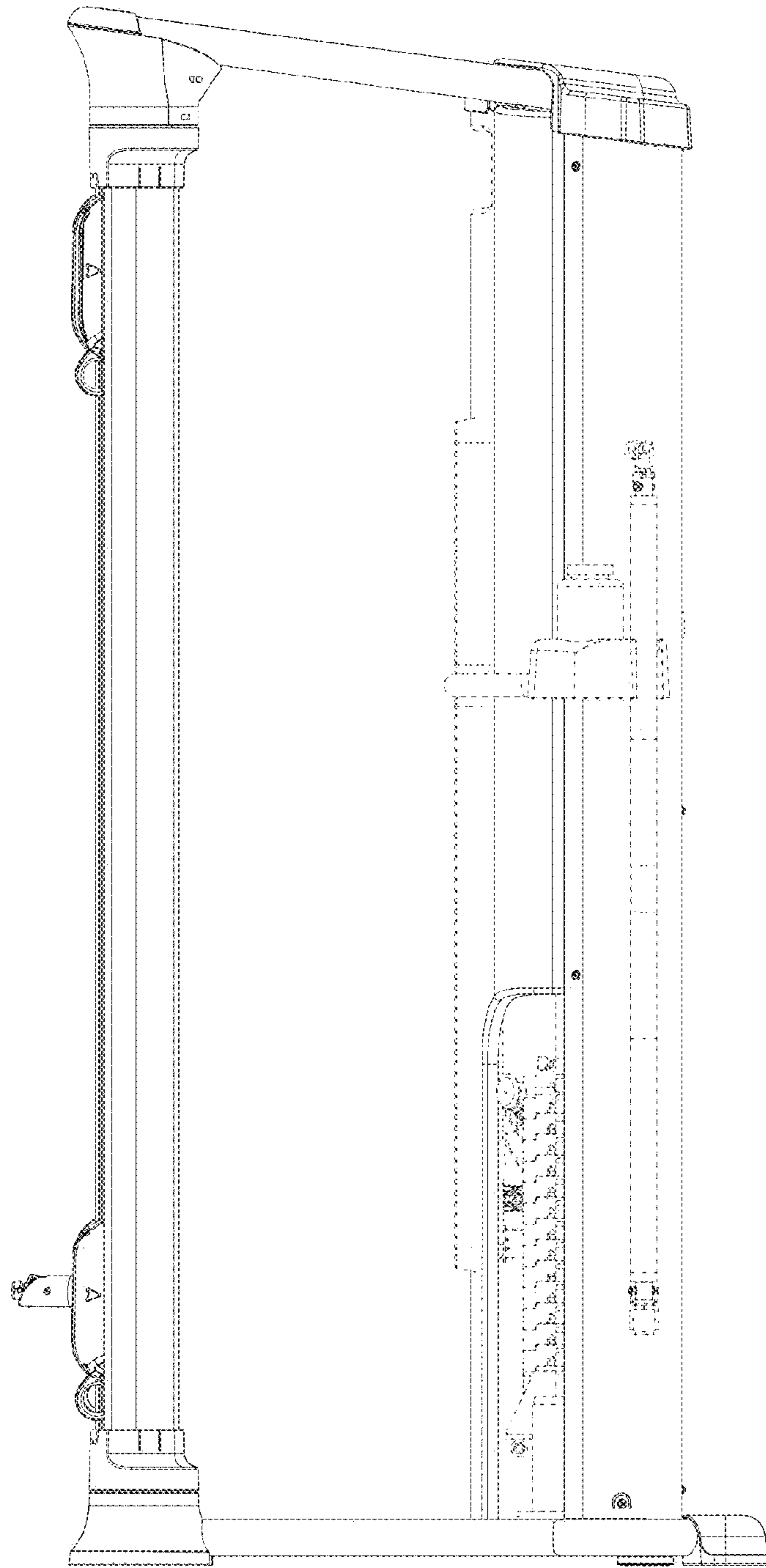

Fig.4

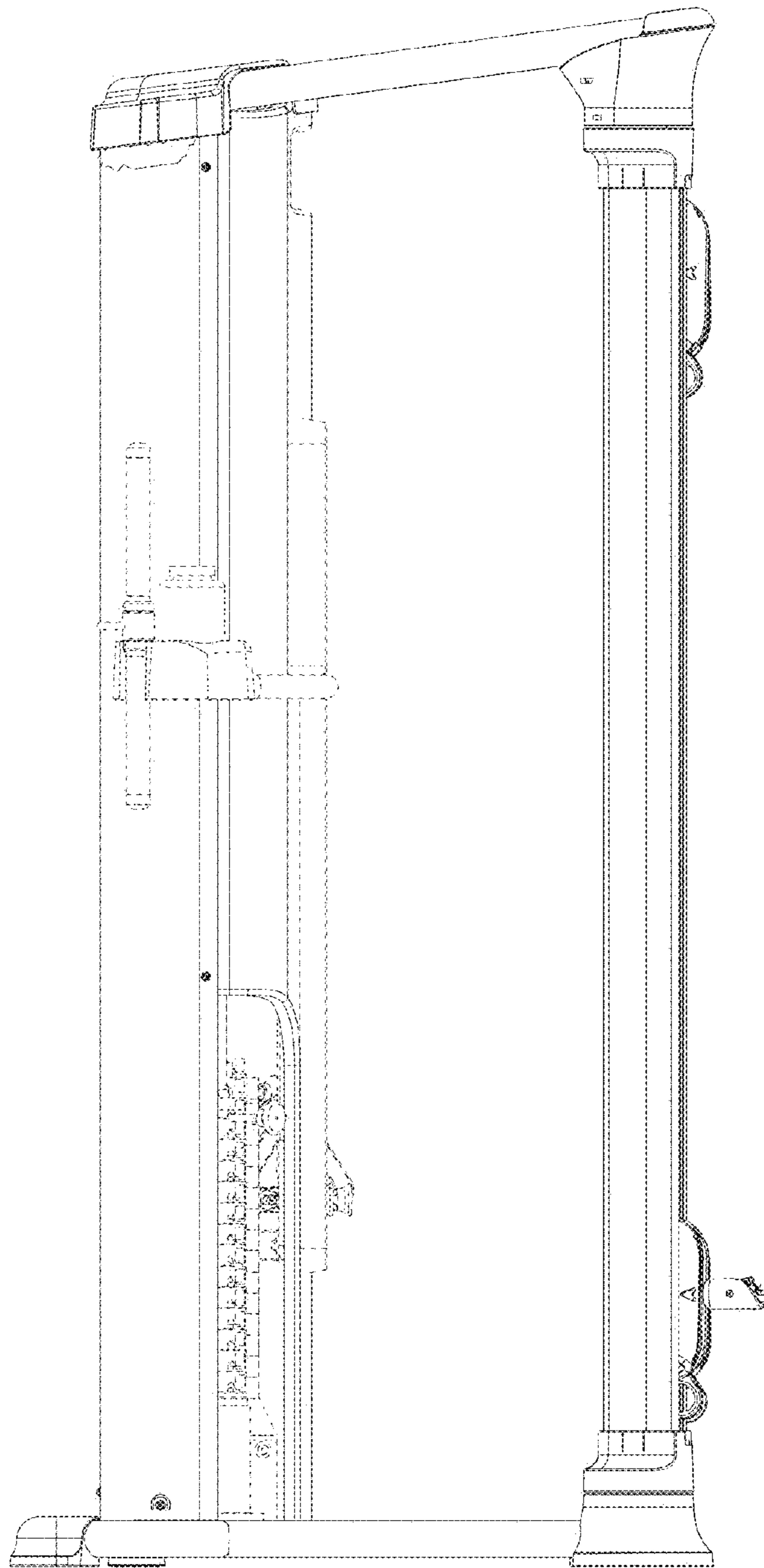

Fig.5

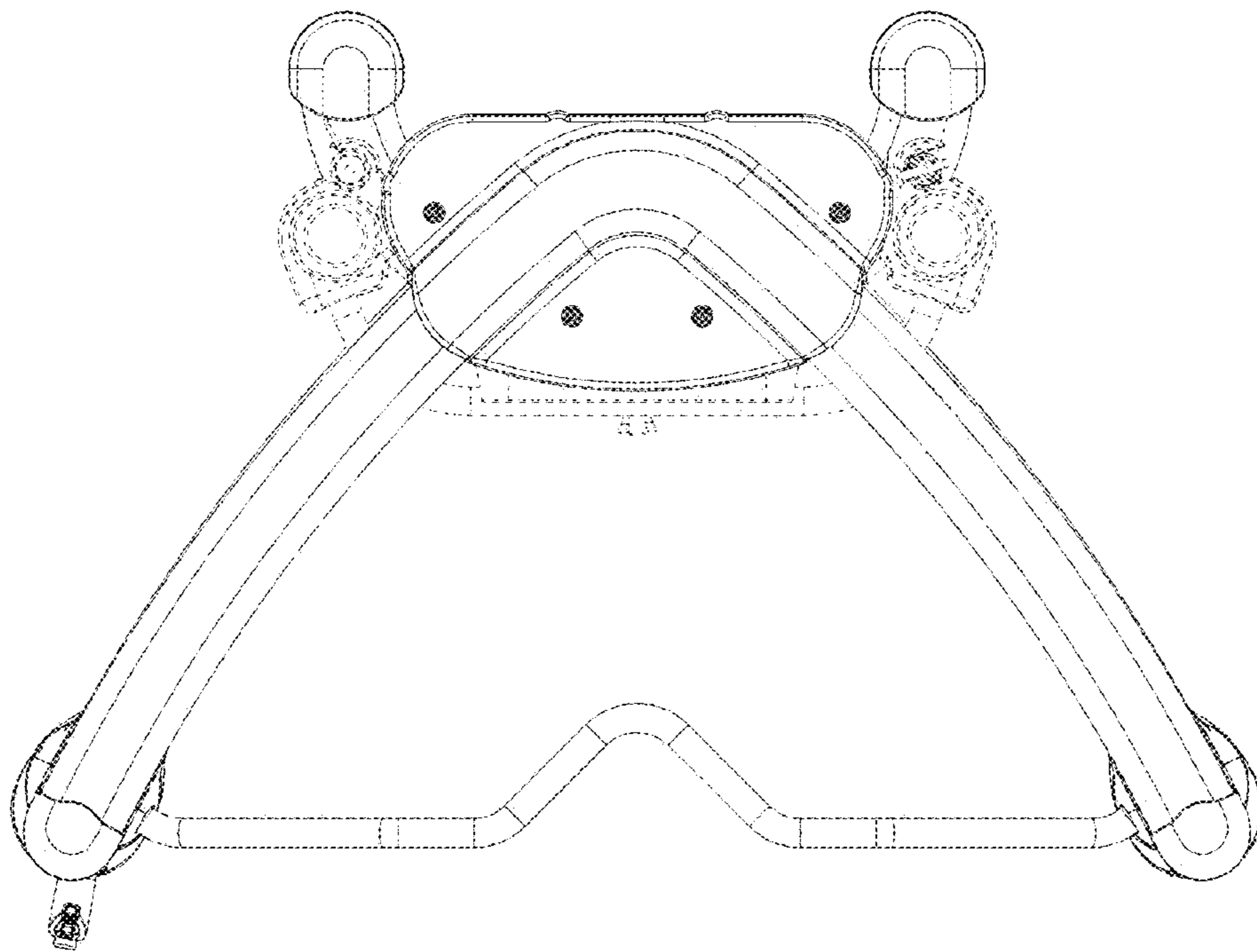

Fig.6

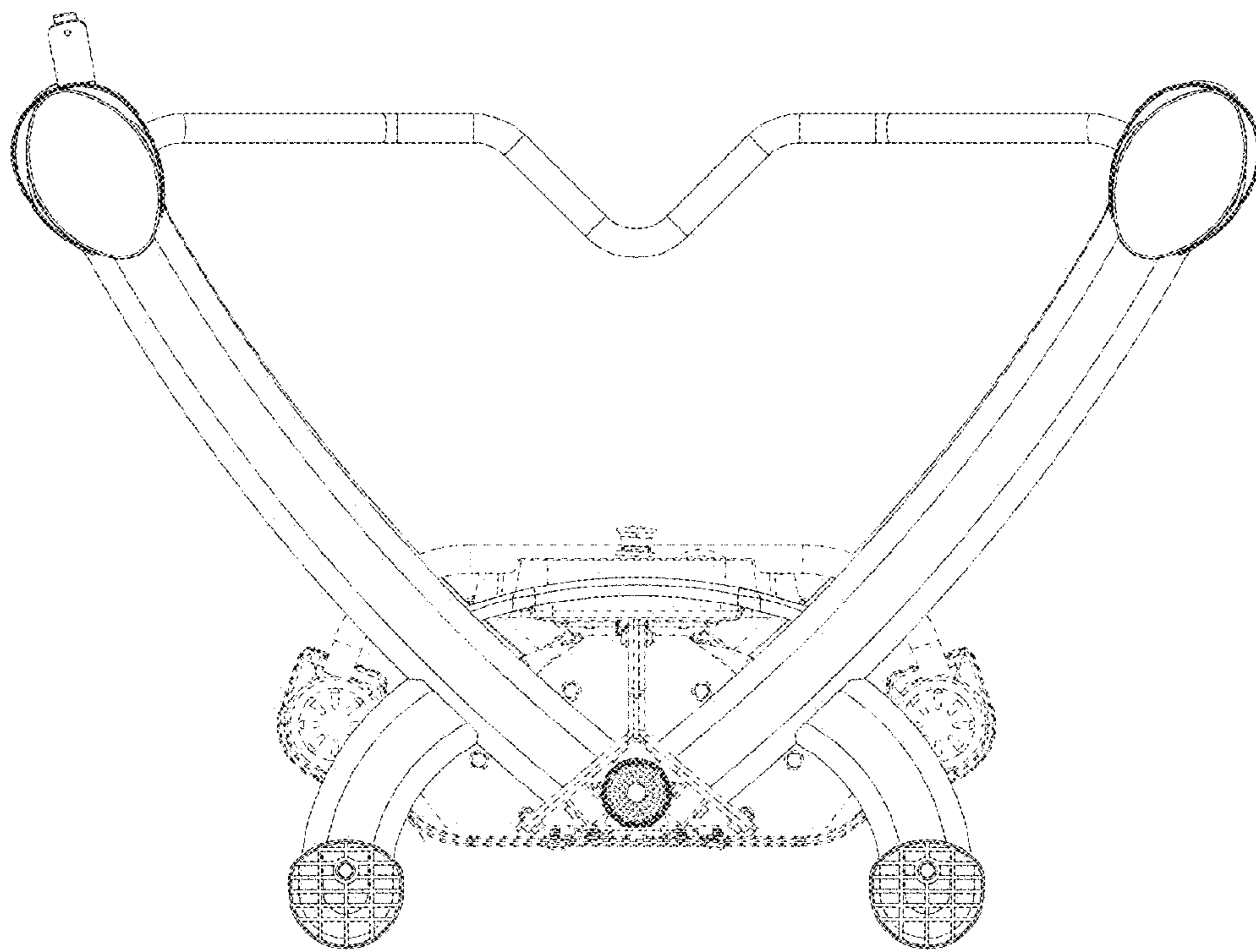

Fig.7