



US00D746141S

(12) **United States Design Patent**
Watabe

(10) **Patent No.:** **US D746,141 S**
(45) **Date of Patent:** **** Dec. 29, 2015**

(54) **BOTTLE**

(71) Applicant: **Kousuke Watabe**, Tokyo (JP)

(72) Inventor: **Kousuke Watabe**, Tokyo (JP)

(73) Assignee: **SHISEIDO CO., LTD.**, Tokyo (JP)

(**) Term: **14 Years**

(21) Appl. No.: **29/493,684**

(22) Filed: **Jun. 12, 2014**

(51) **LOC (10) Cl.** **09-01**

(52) **U.S. Cl.**

USPC **D9/503**; D9/445; D9/452

(58) **Field of Classification Search**

USPC D9/434–435, 444–445, 454, 500,
D9/503–504, 516, 529, 549, 552, 558, 575,
D9/682, 686, 688, 690–691, 715, 719,
D9/723–727, 729; D28/4, 76, 86, 88–89,
D28/91.1

CPC B65D 1/00; B65D 1/02; B65D 1/0223;
B65D 23/00; B65D 81/00; B65D 2501/00;
B65D 2501/0009

See application file for complete search history.

(56) **References Cited**

U.S. PATENT DOCUMENTS

2,670,868	A	*	3/1954	Stover	B65D 43/0222	215/46
D423,922	S	*	5/2000	Ohchi	D9/503	
D427,899	S	*	7/2000	Bougamont	D9/688	
D434,667	S	*	12/2000	Gobe	D9/529	
D472,152	S	*	3/2003	Joubert	D9/529	
D509,739	S	*	9/2005	Haruta	D9/504	
D562,681	S	*	2/2008	Blasko	D9/445	
D585,761	S	*	2/2009	Oates	D9/686	
D599,666	S	*	9/2009	Marotti	D9/454	
D610,021	S	*	2/2010	Kinoshita	D9/686	
D612,239	S	*	3/2010	Marotti	D9/452	
D613,604	S	*	4/2010	Rowland	D9/504	

D615,874	S	*	5/2010	Nagata	D9/448
D632,014	S	*	2/2011	Lee	D28/76
D663,630	S	*	7/2012	White	D9/688
D671,836	S	*	12/2012	DeMarco	D9/503
D683,238	S	*	5/2013	You	D9/688
D691,889	S	*	10/2013	Mettler	D9/454
D705,066	S	*	5/2014	DeMarco	D9/503
D718,138	S	*	11/2014	Komai	D9/503
D720,155	S	*	12/2014	Watabe	D6/536
D730,184	S	*	5/2015	Matsushita	D9/435
D736,624	S	*	8/2015	Berlepsch	D9/451

OTHER PUBLICATIONS

“Scope Outlast Mouthwash—Long Lasting Mint—25oz, 750 mililiter”, SOAP.com, dated in Google image search as being before Jun. 12, 2013, 5 pages, < <http://www.soap.com/p/productname-60669> >.*

“Scope oulast bottle cap”, Google search for images Before Jun. 12, 2013, 1 page, < https://www.google.com/search?q=scope+oulast+bottle+cap&rls=com.microsoft%3Aen-US%3AIE-Address&biw=1668&bih=10044&source=Int&tbs=isz%3A1%2Ccdr%3A1%2Ccd_min%3A%2Ccd_max%3A6%2F12%2F2013&t... >.*

* cited by examiner

Primary Examiner — Dana L Meyrow

(74) *Attorney, Agent, or Firm* — Manabu Kanesaka

(57) **CLAIM**

The ornamental design for a bottle, as shown and described.

DESCRIPTION

FIG. 1 is a perspective view of a bottle showing my new design;

FIG. 2 is a front view thereof;

FIG. 3 is a rear view thereof;

FIG. 4 is a left side view thereof;

FIG. 5 is a right side view thereof;

FIG. 6 is a plan view thereof; and,

FIG. 7 is a bottom view thereof.

1 Claim, 6 Drawing Sheets

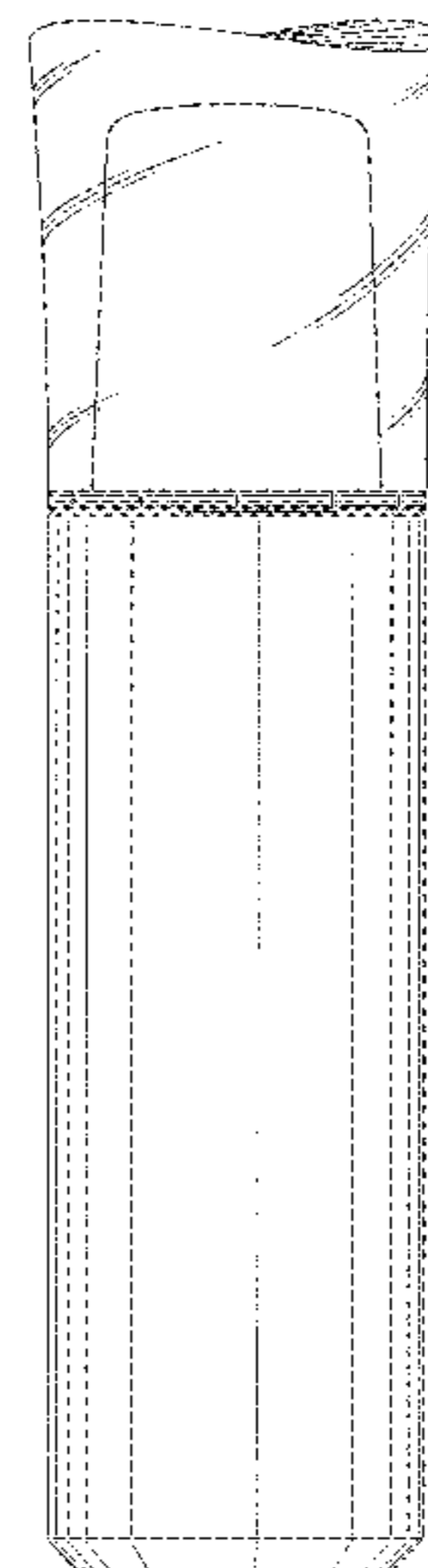
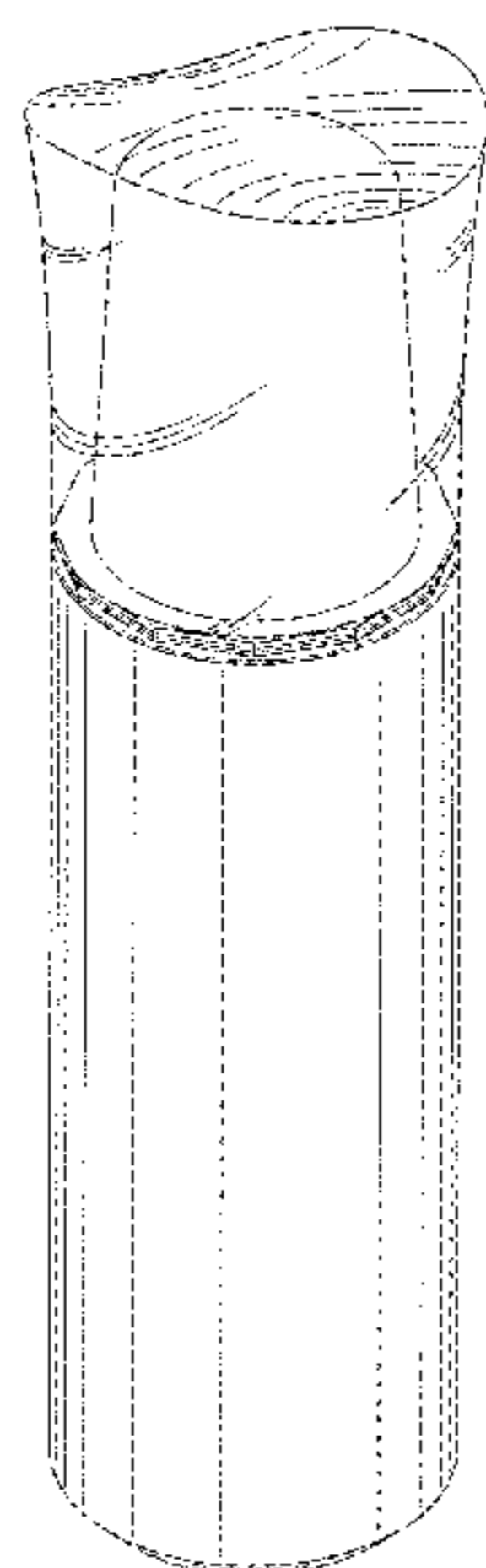

Fig. 1

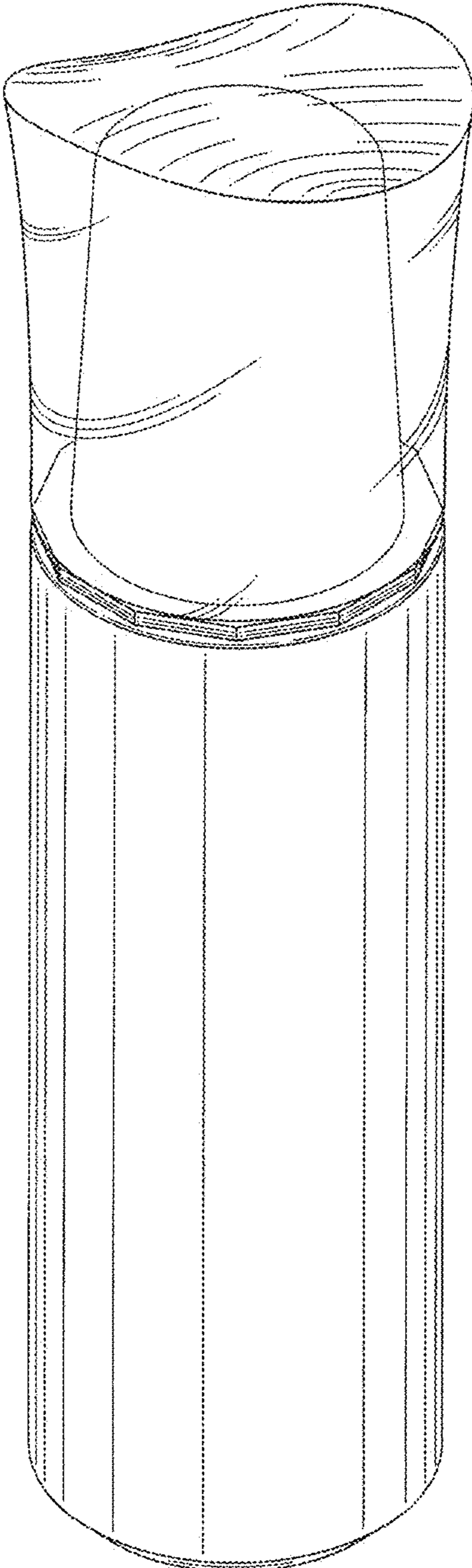

Fig. 2

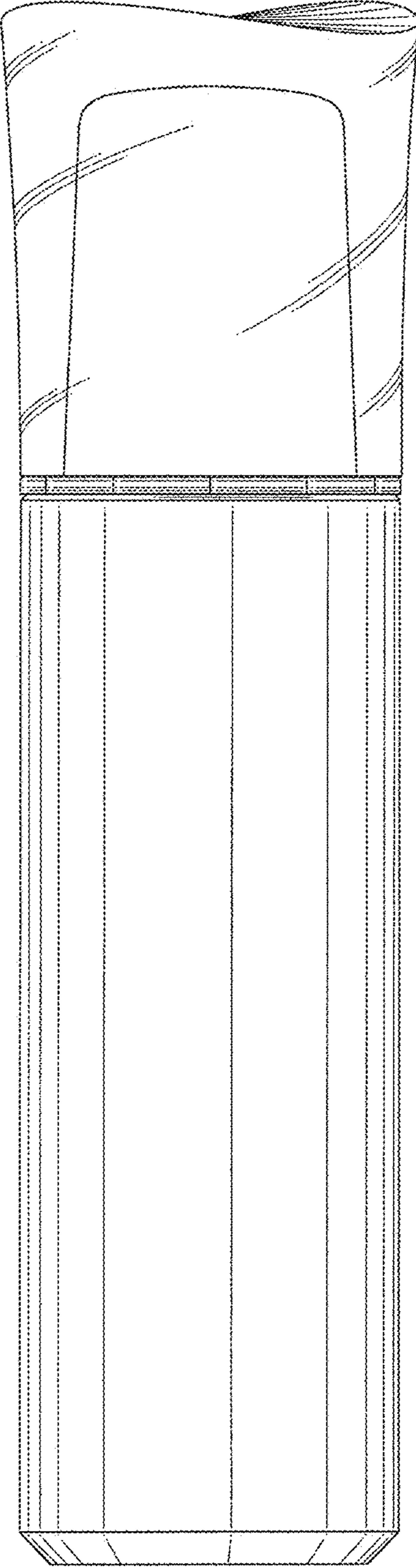

Fig. 3

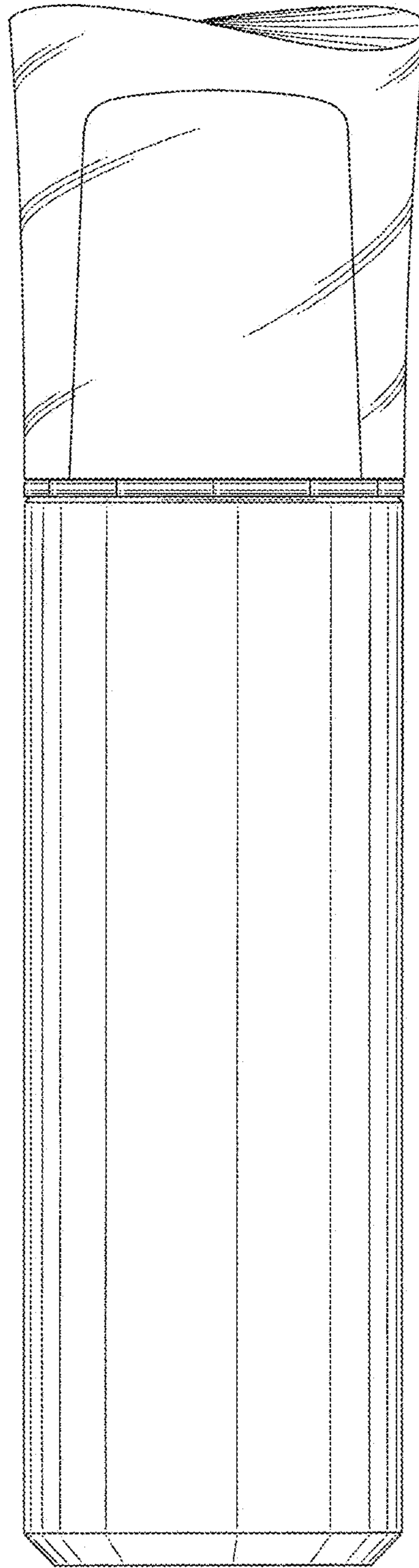

Fig. 4

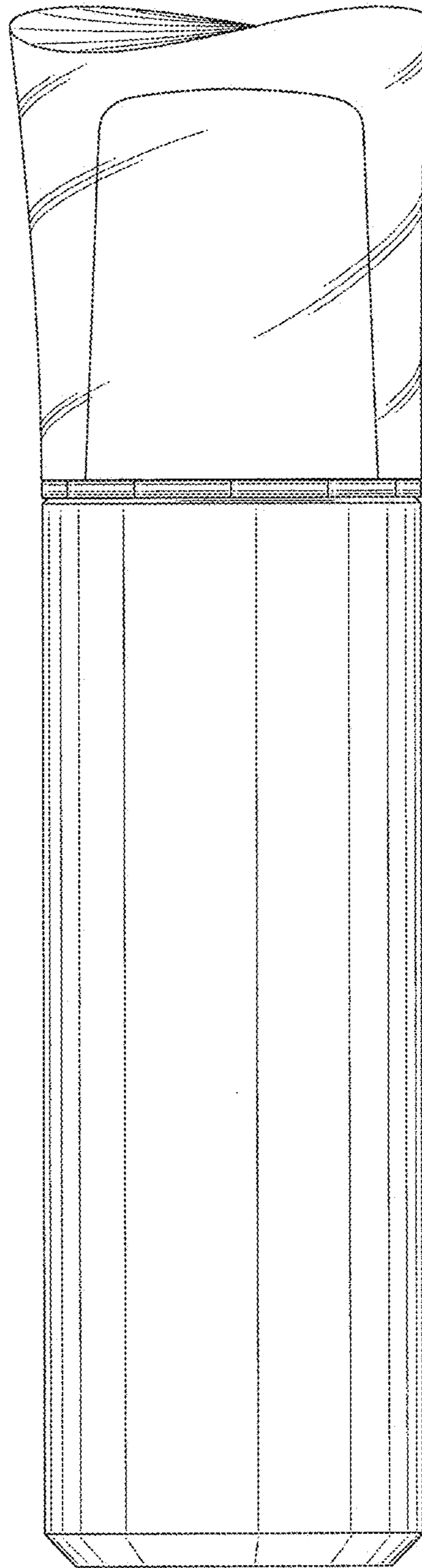

Fig. 5

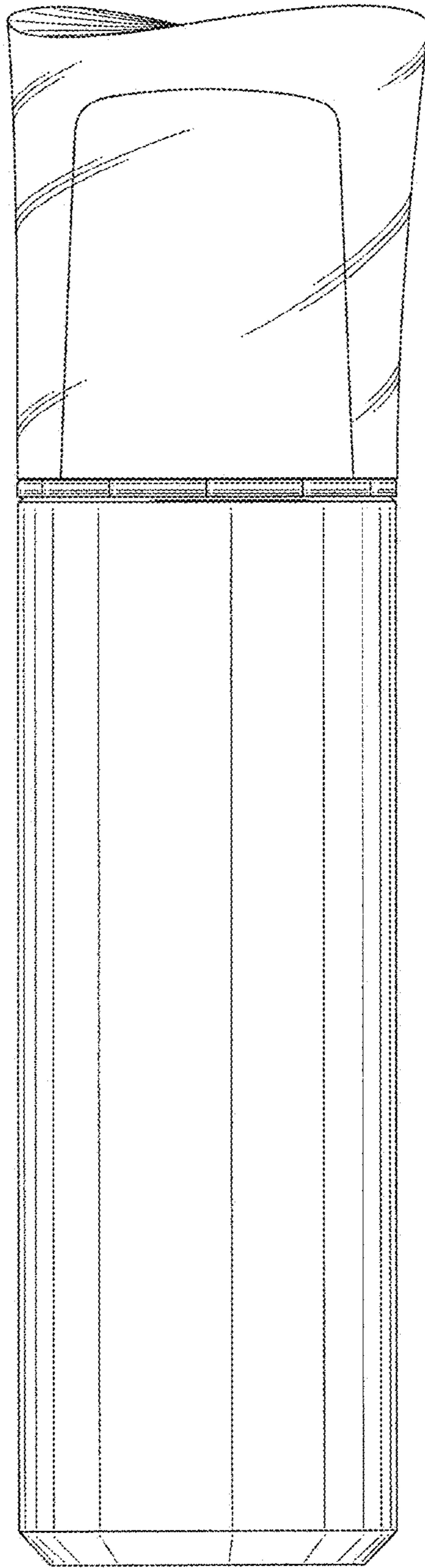

Fig. 6

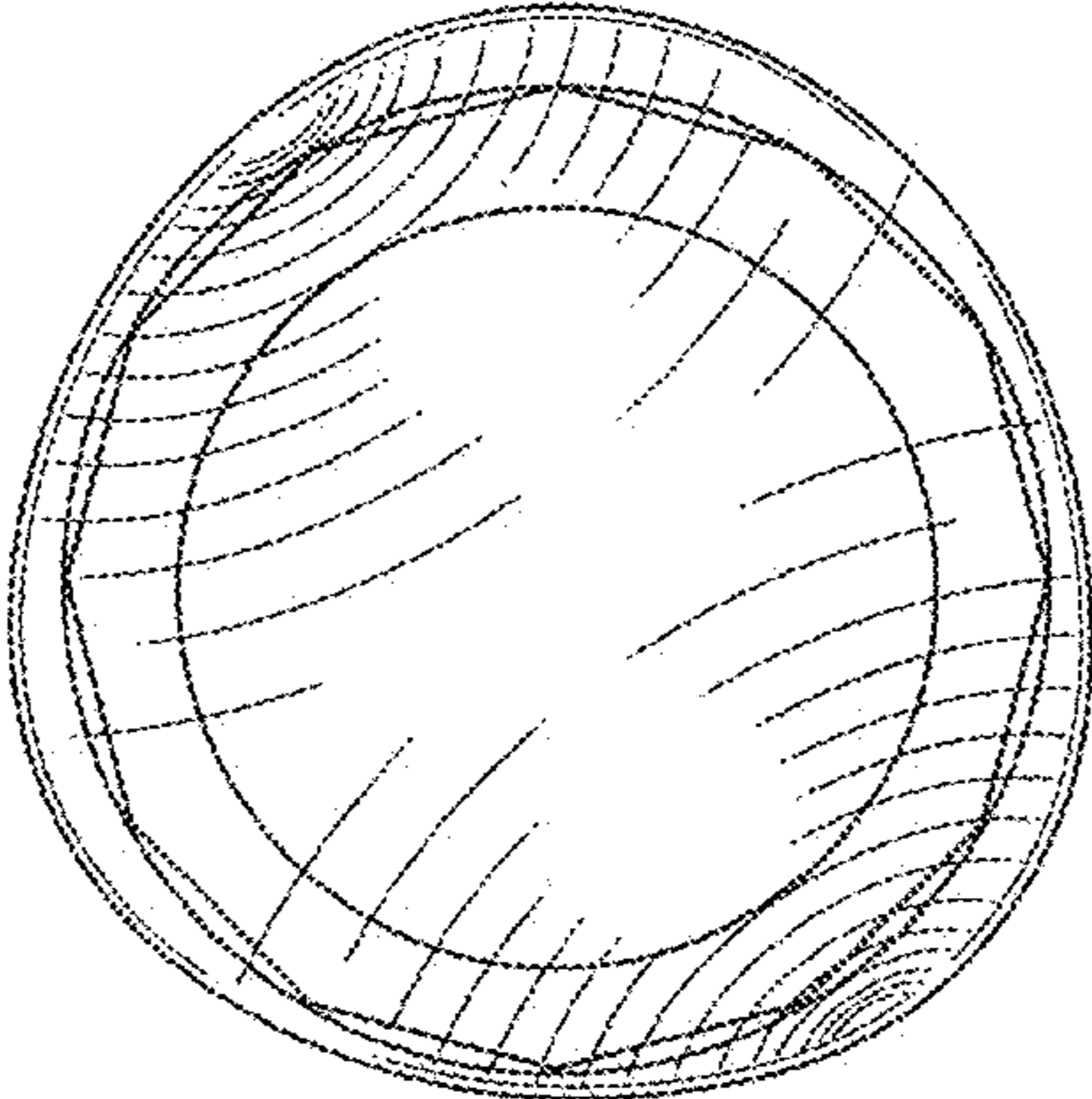

Fig. 7

