



US00D746135S

(12) **United States Design Patent**
Lind

(10) **Patent No.:** **US D746,135 S**

(45) **Date of Patent:** **** *Dec. 29, 2015**

(54) **AEROSOL ACTUATOR FOR AN AEROSOL DEVICE**

(56) **References Cited**

U.S. PATENT DOCUMENTS

(71) Applicant: **Meadwestvaco Calmar, Inc.**,
Richmond, VA (US)

D476,558 S 7/2003 Cho et al.

D481,305 S 10/2003 Walters et al.

D525,123 S 7/2006 Walters et al.

D536,970 S 2/2007 Shannan et al.

D538,650 S 3/2007 Paas et al.

7,249,692 B2 7/2007 Walters et al.

D569,247 S * 5/2008 Decottignies D9/448

D580,761 S 11/2008 Sweeton

D582,272 S 12/2008 Cichy

D595,575 S * 7/2009 Cichy D9/448

D613,599 S 4/2010 Khubani

D623,517 S 9/2010 Pechinot

D649,053 S * 11/2011 Van den Broeck et al. D9/448

D650,671 S * 12/2011 Althaus et al. D9/448

2010/0219211 A1 9/2010 Smith et al.

(72) Inventor: **James Lind**, Lenexa, KS (US)

(73) Assignee: **WestRock Dispensing Systems, Inc.**,
Norcross, GA (US)

(*) Notice: This patent is subject to a terminal disclaimer.

(**) Term: **14 Years**

* cited by examiner

(21) Appl. No.: **29/491,149**

Primary Examiner — Robert M Spear

(22) Filed: **May 16, 2014**

(74) *Attorney, Agent, or Firm* — WestRock Company

Related U.S. Application Data

(57) **CLAIM**

The ornamental design for an aerosol actuator for an aerosol device, as shown and described.

(62) Division of application No. 29/412,424, filed on Feb. 2, 2012, now Pat. No. Des. 710,697.

DESCRIPTION

(51) **LOC (10) Cl.** **09-07**

FIG. 1 is a perspective view of an aerosol actuator for an aerosol device showing the new design; FIG. 2 is a front view of the new design; FIG. 3 is a back view of the new design; FIG. 4 is a right view of the new design; FIG. 5 is a left view of the new design; and, FIG. 6 is a top view of the new design.

(52) **U.S. Cl.**
USPC **D9/448**

The broken-line disclosure is understood to represent unclaimed portions of the article in which the claimed design is embodied.

(58) **Field of Classification Search**
USPC D9/434, 435, 448, 449; D23/213, 226;
222/323, 383.1, 383.3, 402.15;
239/120, 215, 333, 394, 526, 539;
417/178, 198, 411

See application file for complete search history.

1 Claim, 4 Drawing Sheets

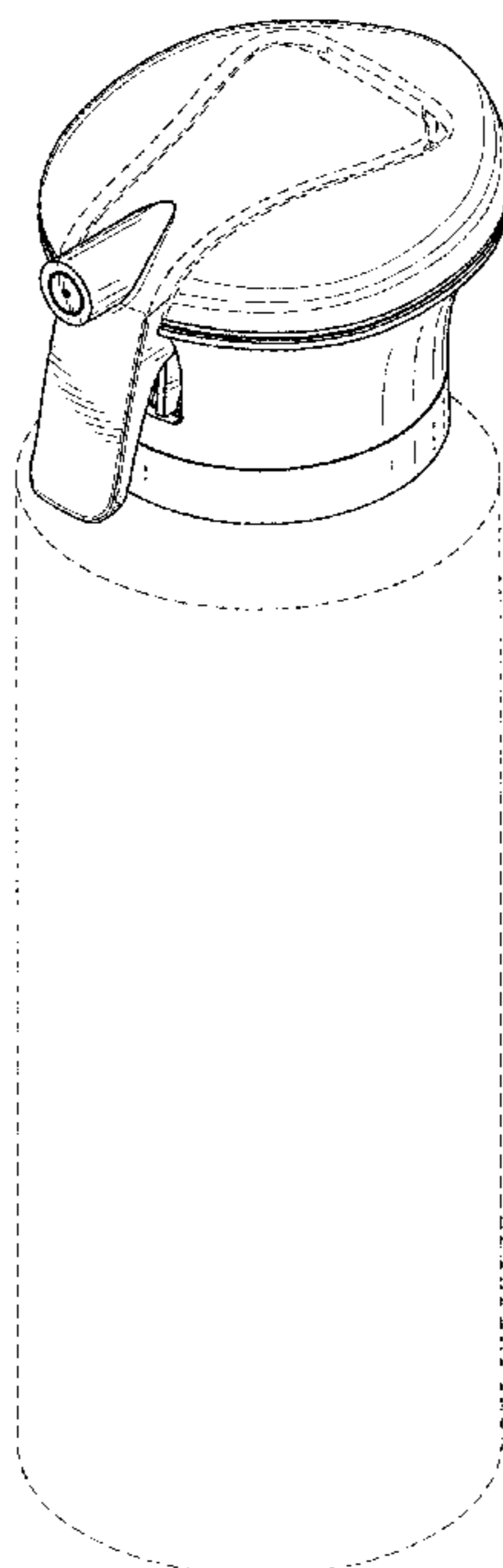

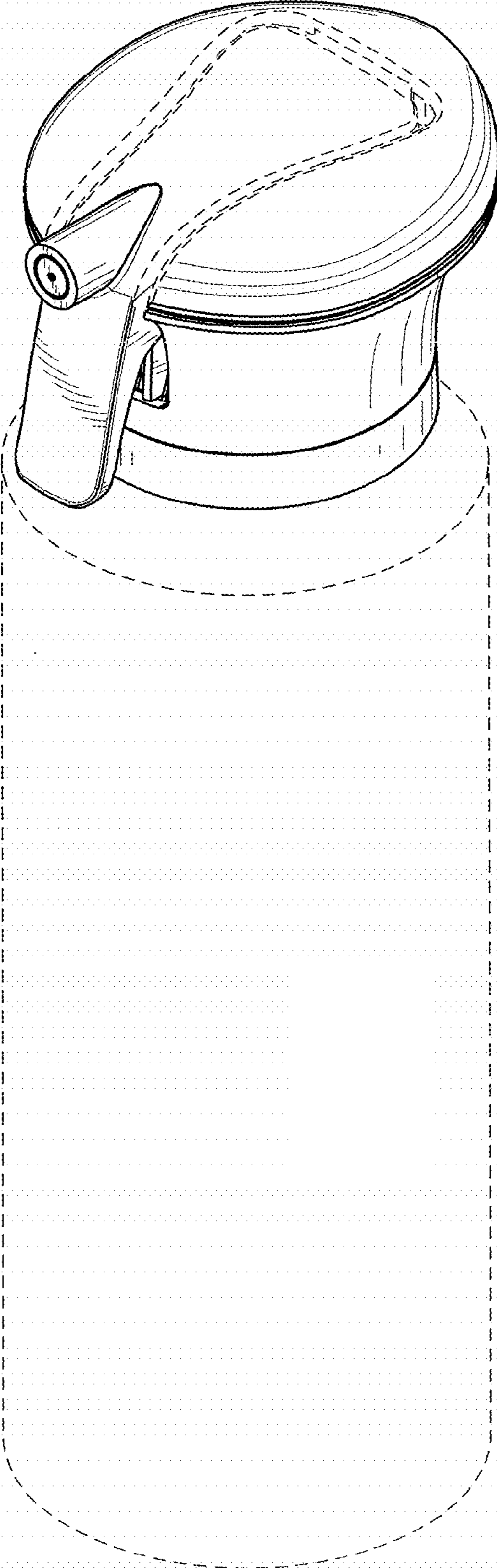

FIG. 1

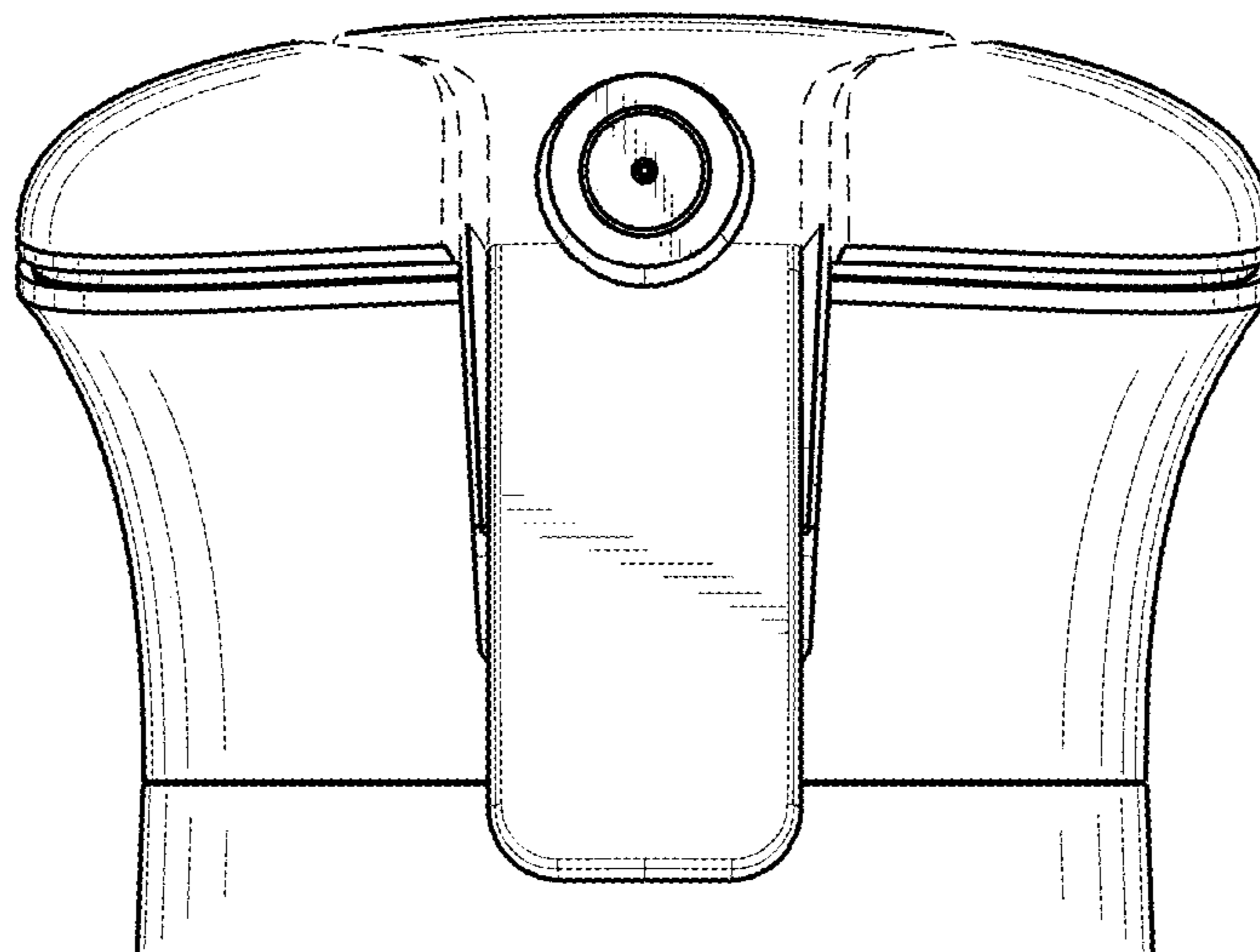

FIG. 2

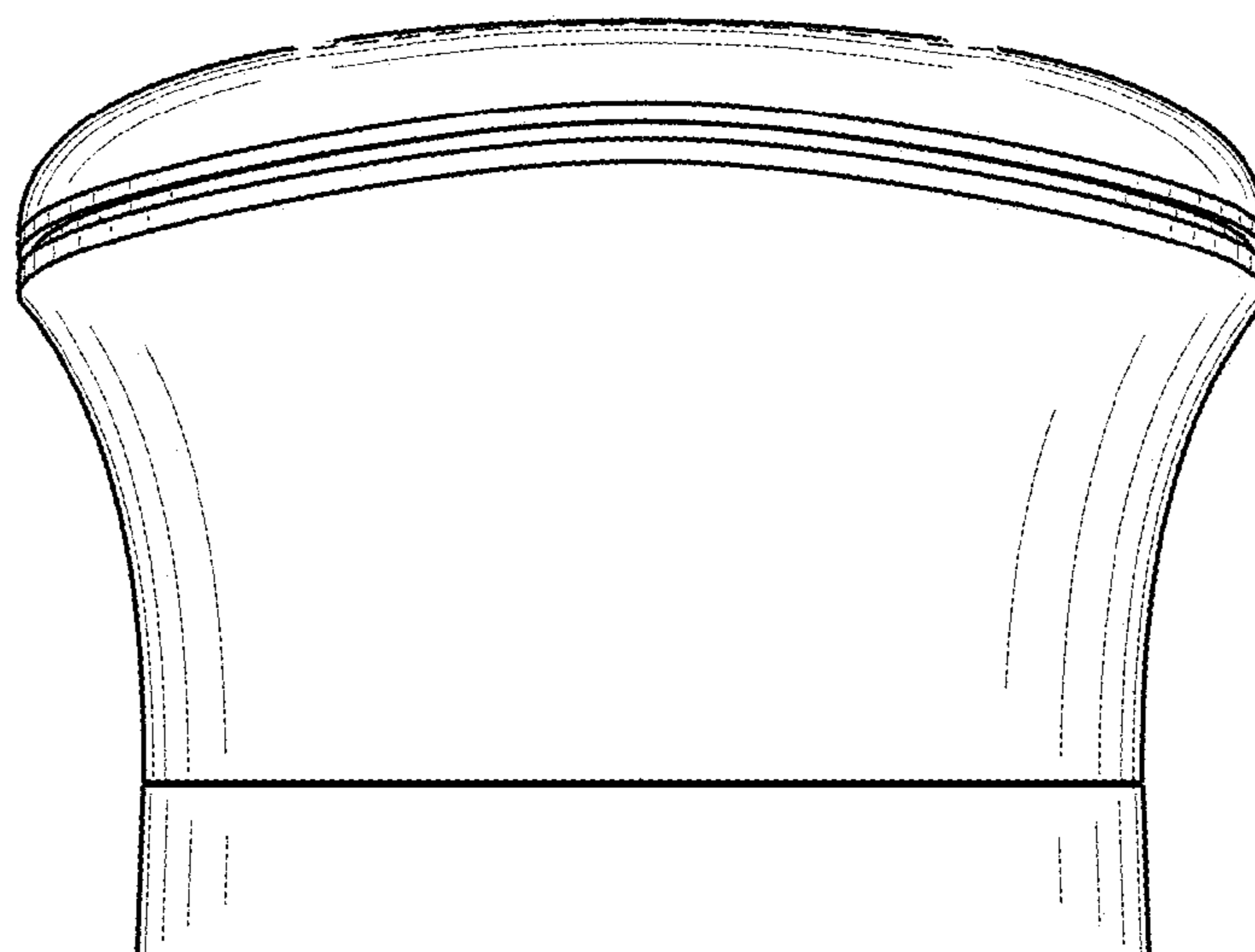

FIG. 3

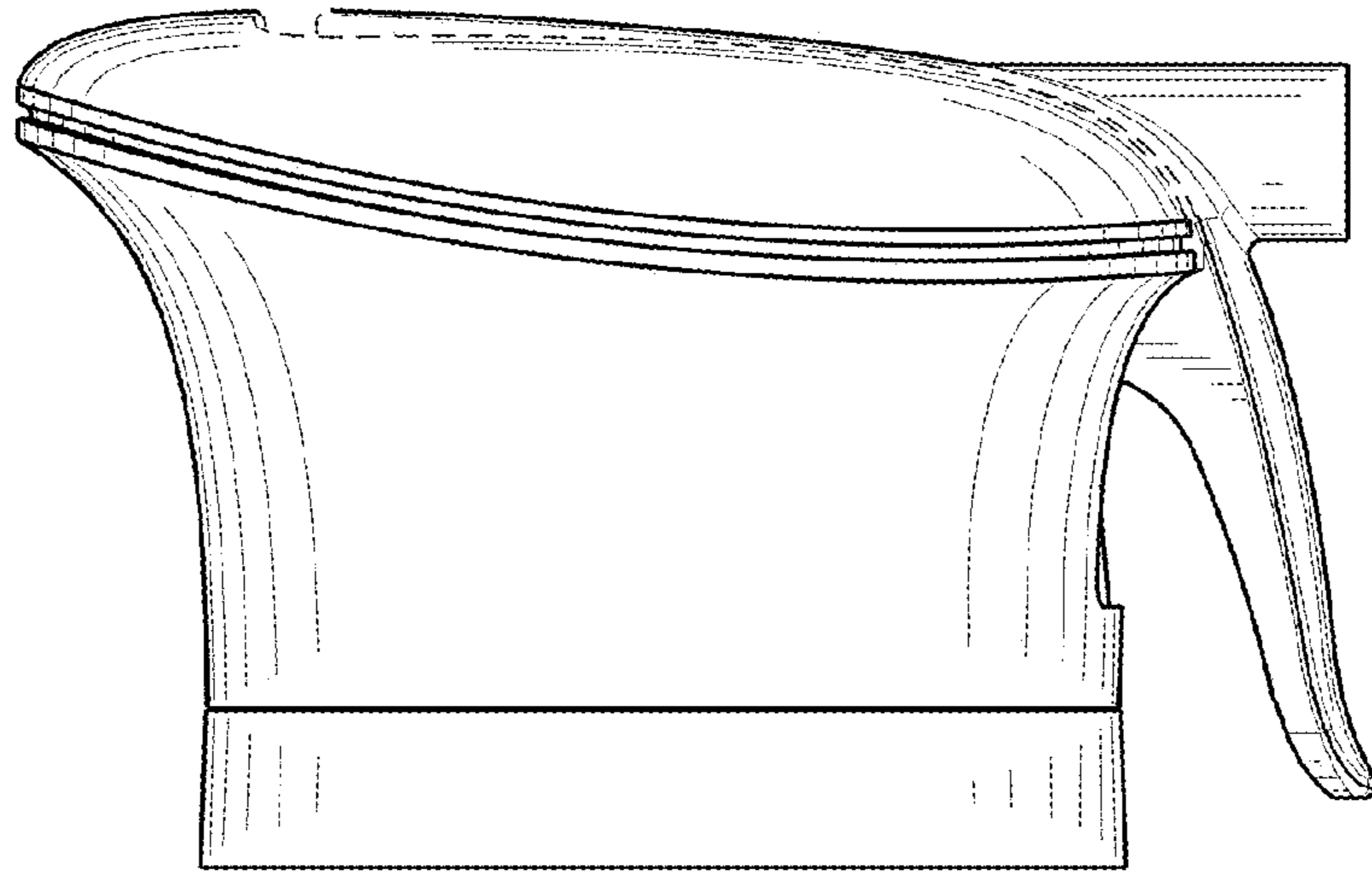

FIG. 4

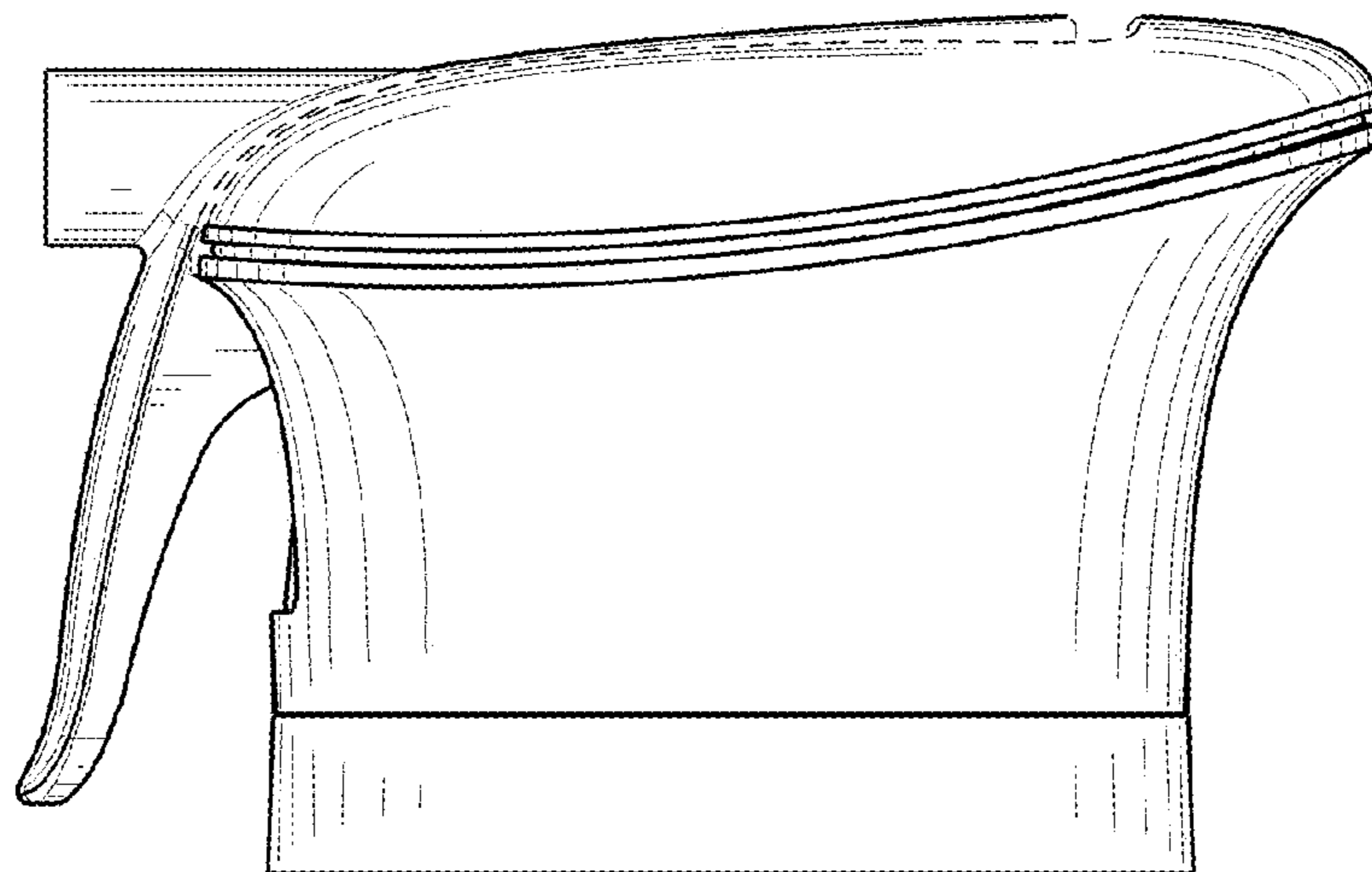

FIG. 5

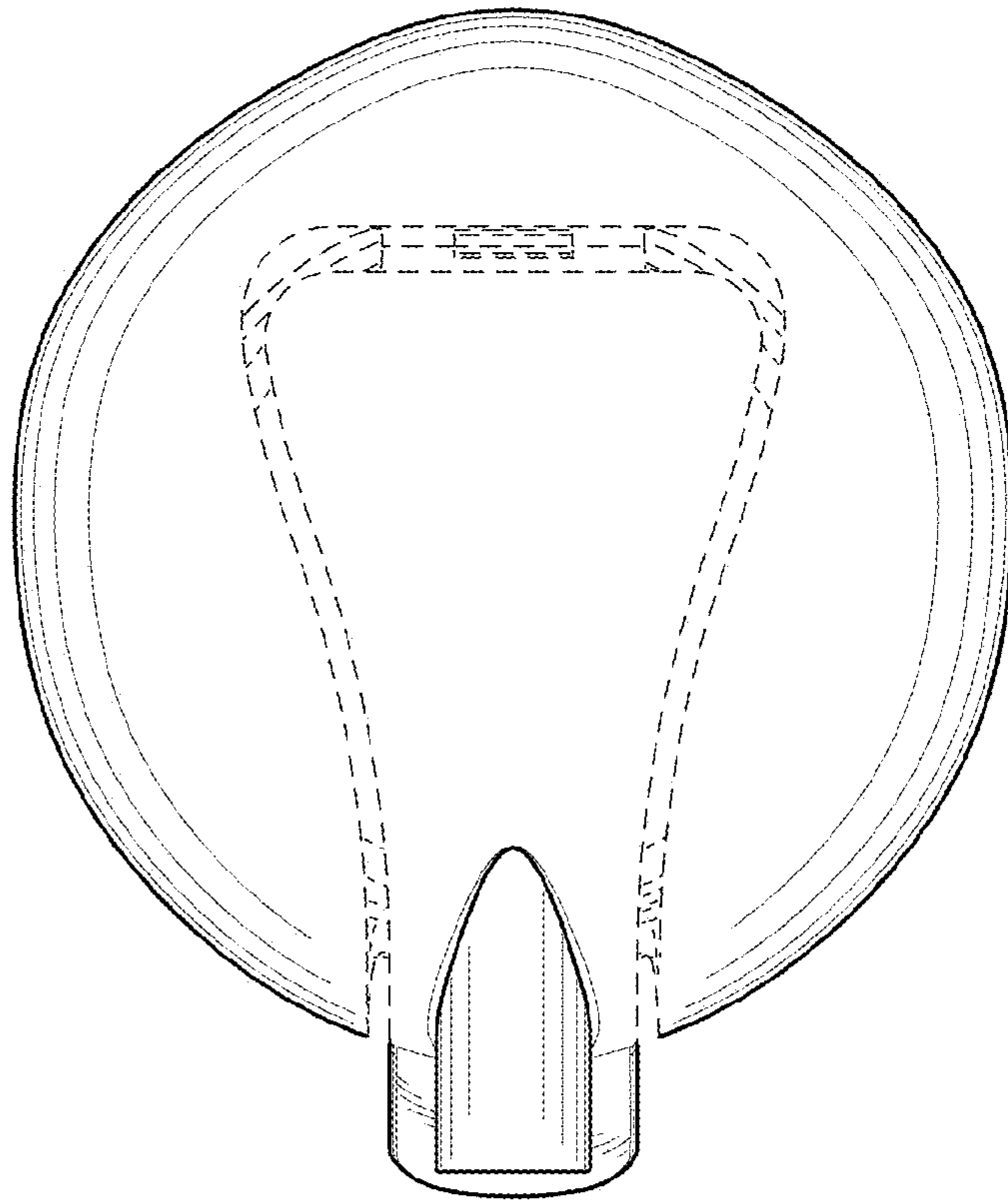

FIG. 6