



US00D746120S

(12) **United States Design Patent**  
**Pelton**

(10) **Patent No.:** **US D746,120 S**

(45) **Date of Patent:** **\*\* Dec. 29, 2015**

(54) **CURVED BLADE KNIFE WITH INTEGRATED MOVEABLE GUARD**

(71) Applicant: **DPX VENTURES LIMITED**, Ras Al Khaimah (AE)

(72) Inventor: **Robert Young Pelton**, Bonsall, CA (US)

(73) Assignee: **DPX VENTURES LIMITED**, Ras Al Khaimah (AE)

(\*\*) Term: **14 Years**

(21) Appl. No.: **29/479,218**

(22) Filed: **Jan. 13, 2014**

(51) **LOC (10) Cl.** ..... **08-03**

(52) **U.S. Cl.**  
USPC ..... **D8/99**

(58) **Field of Classification Search**

USPC ..... D8/98, 99, 105; D22/118

CPC ..... B26B 3/06; B26B 1/00; B26B 1/04;  
B26B 29/02; B26B 3/00

See application file for complete search history.

(56) **References Cited**

**U.S. PATENT DOCUMENTS**

D229,472 S \* 12/1973 Collins ..... D7/649

D270,655 S \* 9/1983 Collins ..... D22/118

(Continued)

**OTHER PUBLICATIONS**

Camillus Dominator Carbonitride Titanium Fixed Blade Knife, retrieved from www.amazon.com on Feb. 10, 2014, 3 pages.

*Primary Examiner* — Phillip S Hyder

(74) *Attorney, Agent, or Firm* — ARC IP Law, PC; Joesph J. Mayo

(57) **CLAIM**

The ornamental design for a curved blade knife with integrated moveable guard, as shown and described.

**DESCRIPTION**

FIG. 1 is an upper perspective view of a curved blade knife with integrated moveable guard in closed position.

FIG. 2 is a lower perspective view of the curved blade knife with integrated moveable guard in closed position.

FIG. 3 is an upper perspective view of the curved blade knife with integrated moveable guard in open position.

FIG. 4 is a lower perspective view of the curved blade knife with integrated moveable guard in open position.

FIG. 5 is a left side view of the curved blade knife with integrated moveable guard in open position.

FIG. 6 is a left side view of the curved blade knife with integrated moveable guard in half open position.

FIG. 7 is a left side view of the curved blade knife with integrated moveable guard in closed position, the right side views of which are not shown as they are mirror images of FIGS. 5, 6 and 7 respectively.

FIG. 8 is a top view of the curved blade knife with integrated moveable guard in closed position.

FIG. 9 is a top view of the curved blade knife with integrated moveable guard in half open position.

FIG. 10 is a top view of the curved blade knife with integrated moveable guard in open position.

FIG. 11 is a bottom view of the curved blade knife with integrated moveable guard in closed position.

FIG. 12 is a bottom view of the curved blade knife with integrated moveable guard in half open position.

FIG. 13 is a bottom view of the curved blade knife with integrated moveable guard in open position.

FIG. 14 is a front view of the curved blade knife with integrated moveable guard in closed position.

FIG. 15 is a front view of the curved blade knife with integrated moveable guard in half open position.

FIG. 16 is a front view of the curved blade knife with integrated moveable guard in open position.

FIG. 17 is a rear view of the curved blade knife with integrated moveable guard in closed position.

FIG. 18 is a rear view of the curved blade knife with integrated moveable guard in half open position; and,

FIG. 19 is a rear view of the curved blade knife with integrated moveable guard in open position.

Any broken line showing is for environmental purposes only and forms no part of the claimed design.

**1 Claim, 9 Drawing Sheets**

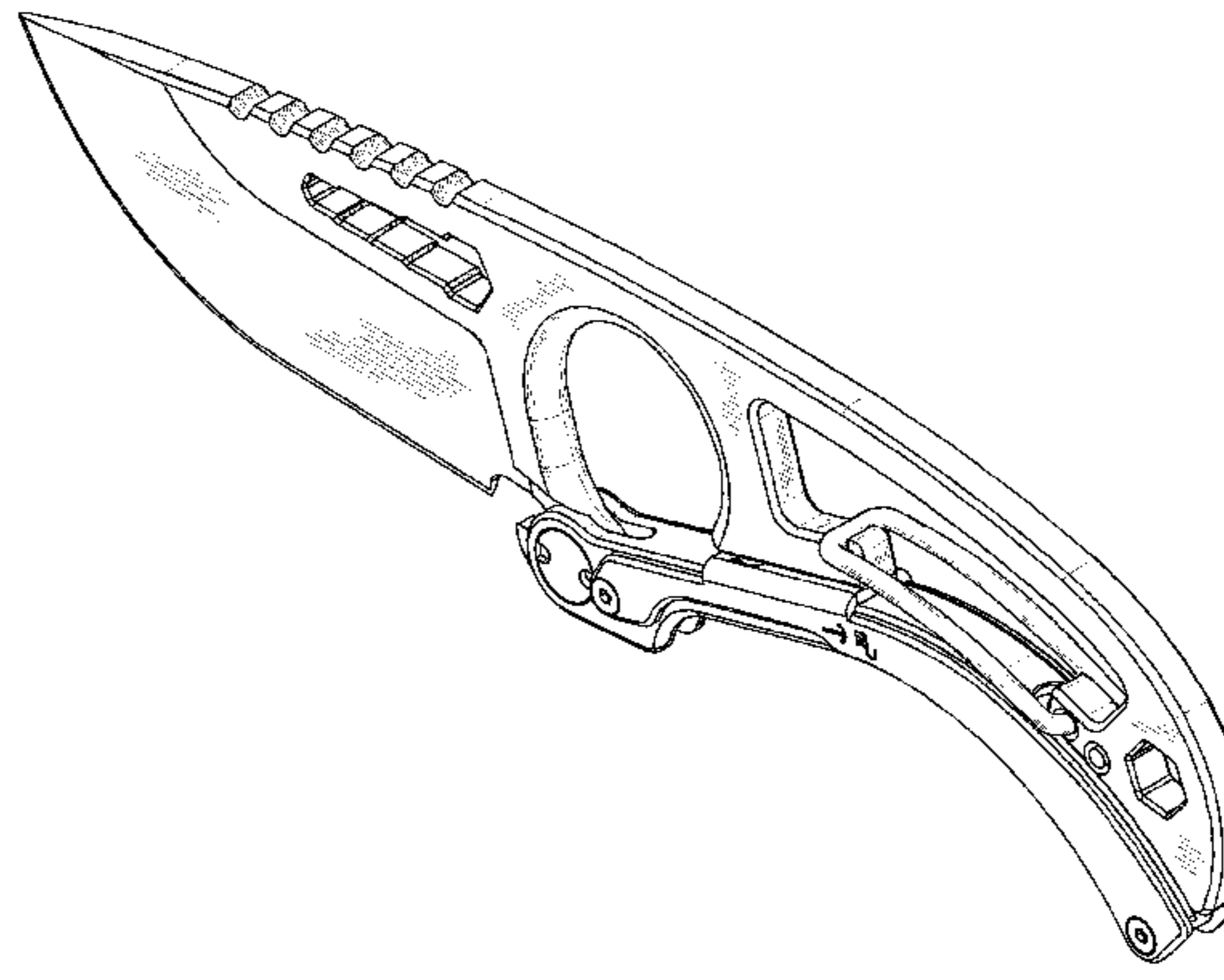
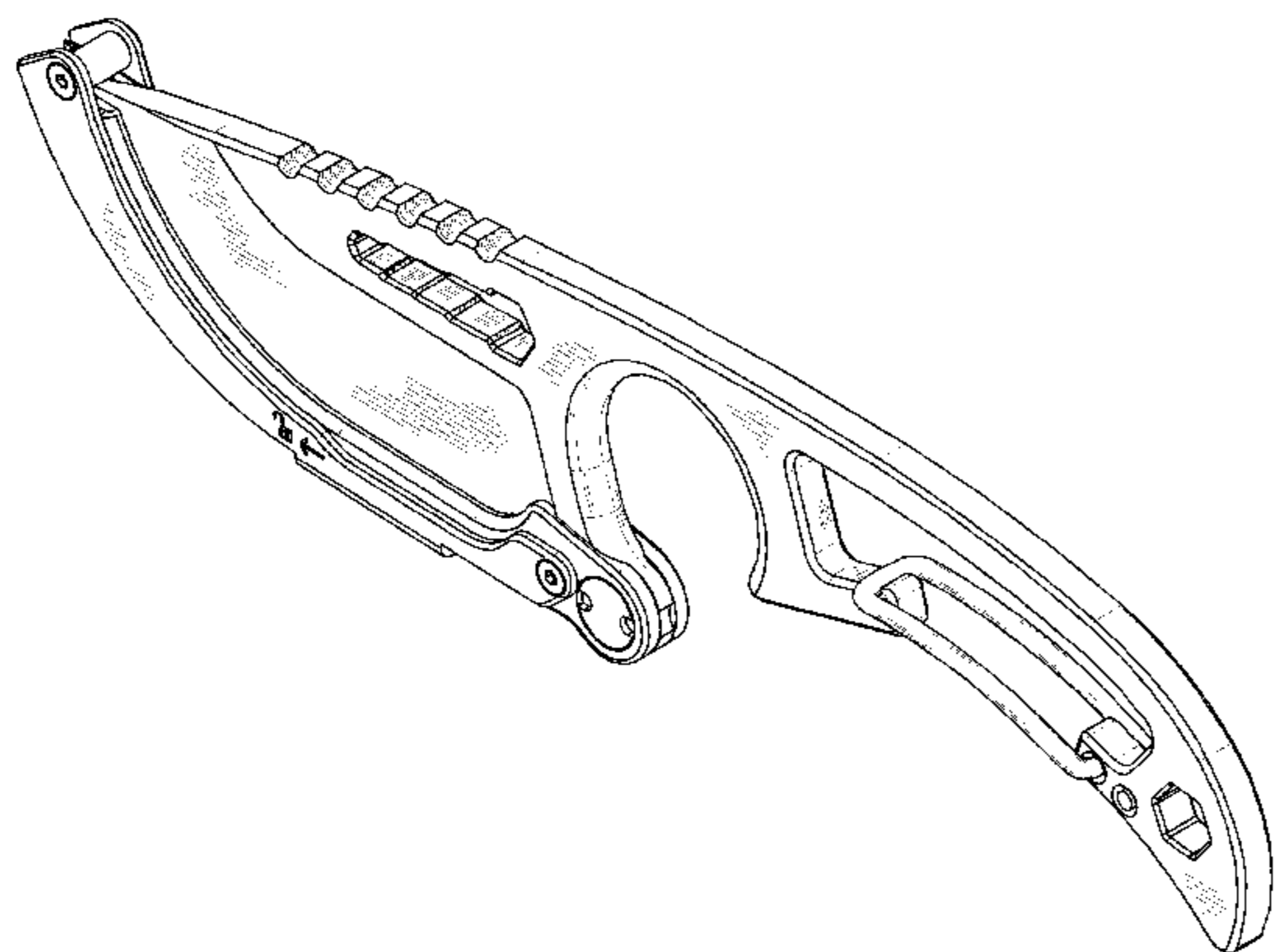

(56)

**References Cited**

U.S. PATENT DOCUMENTS

4,442,559 A 4/1984 Collins  
 4,546,510 A \* 10/1985 Harrison ..... 7/145  
 4,607,432 A \* 8/1986 Montgomery ..... 30/294  
 D336,232 S \* 6/1993 Thompson et al. .... D8/99  
 D422,190 S \* 4/2000 Zaha ..... D8/99  
 D464,511 S \* 10/2002 Clarke et al. .... D6/472  
 D464,551 S 10/2002 Glesser  
 6,594,906 B1 7/2003 Sakai et al.  
 7,051,443 B2 5/2006 Mueller  
 7,325,312 B1 2/2008 Janich

D566,222 S \* 4/2008 Hawk et al. .... D22/118  
 8,079,148 B2 12/2011 Chao  
 8,117,754 B2 2/2012 Lion et al.  
 8,322,039 B2 12/2012 De Buyer-Mimeure  
 D699,315 S \* 2/2014 Seeds et al. .... D22/118  
 8,707,490 B1 4/2014 Pelton  
 2006/0277762 A1 12/2006 Knight et al.  
 2012/0272534 A1 11/2012 Lee  
 2013/0167381 A1 7/2013 Kommer  
 2013/0185943 A1 7/2013 Landwehr  
 2014/0250694 A1 9/2014 Constantine  
 2014/0345144 A1 11/2014 Frazer

\* cited by examiner

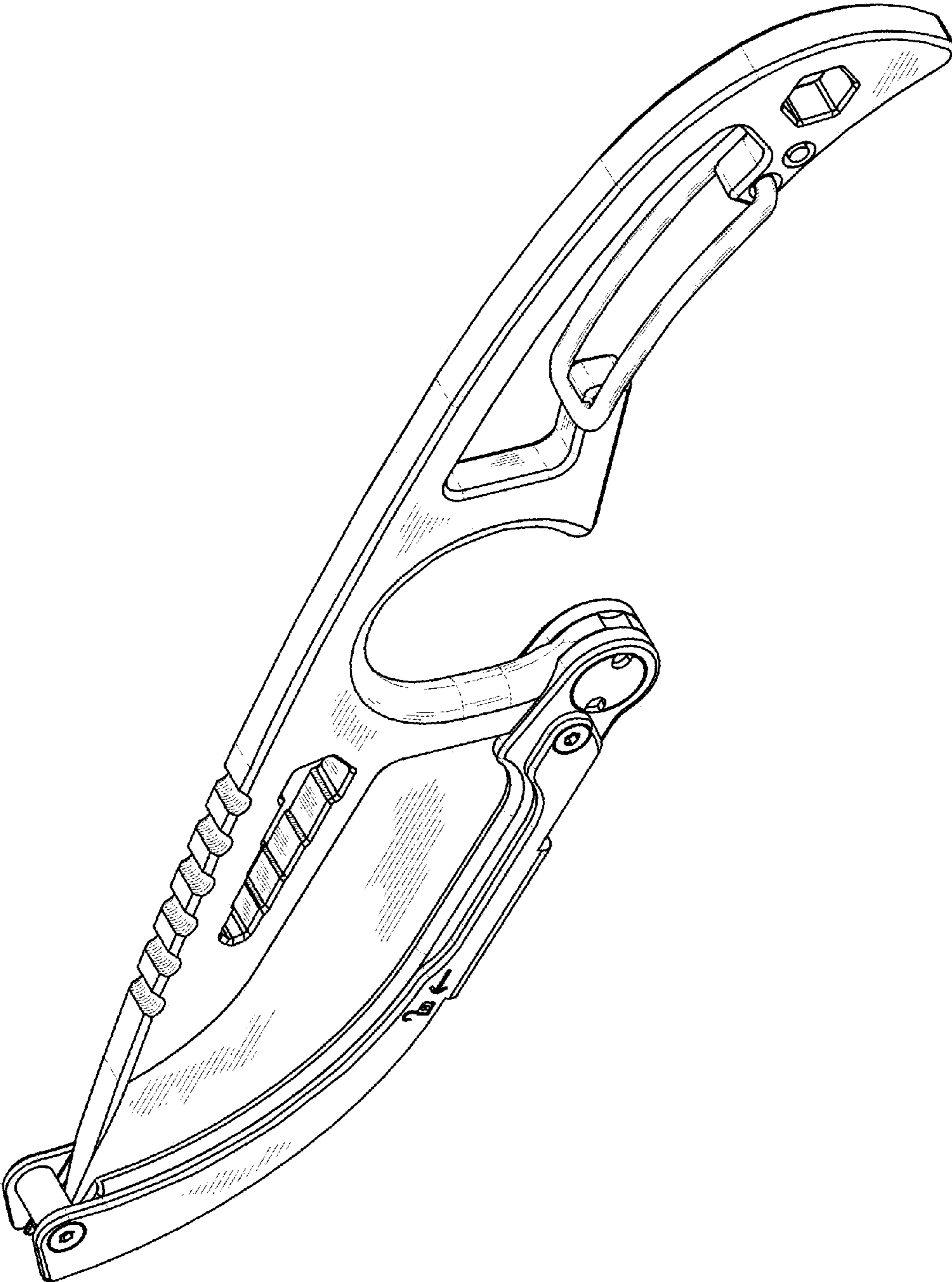

FIG. 1

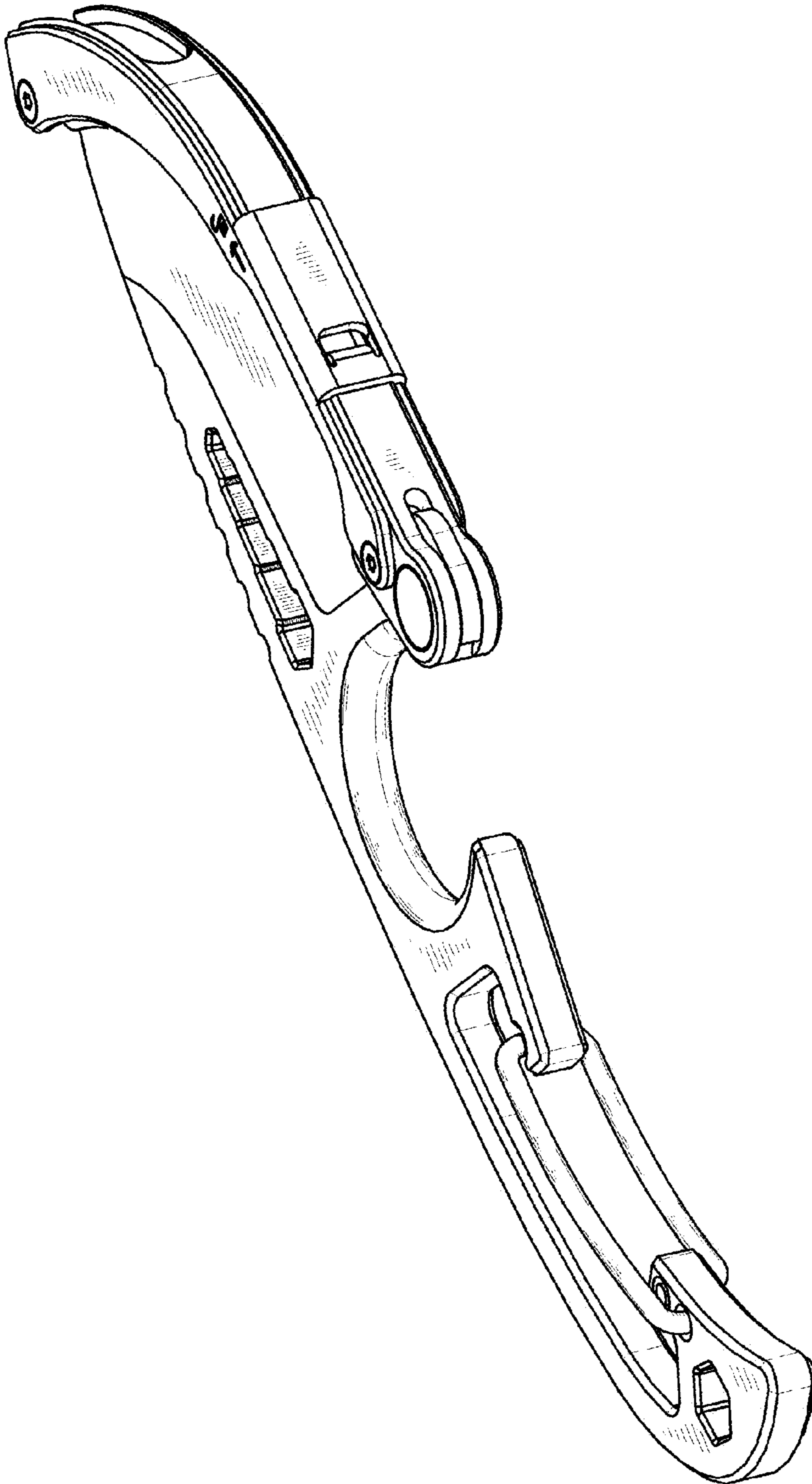

FIG. 2

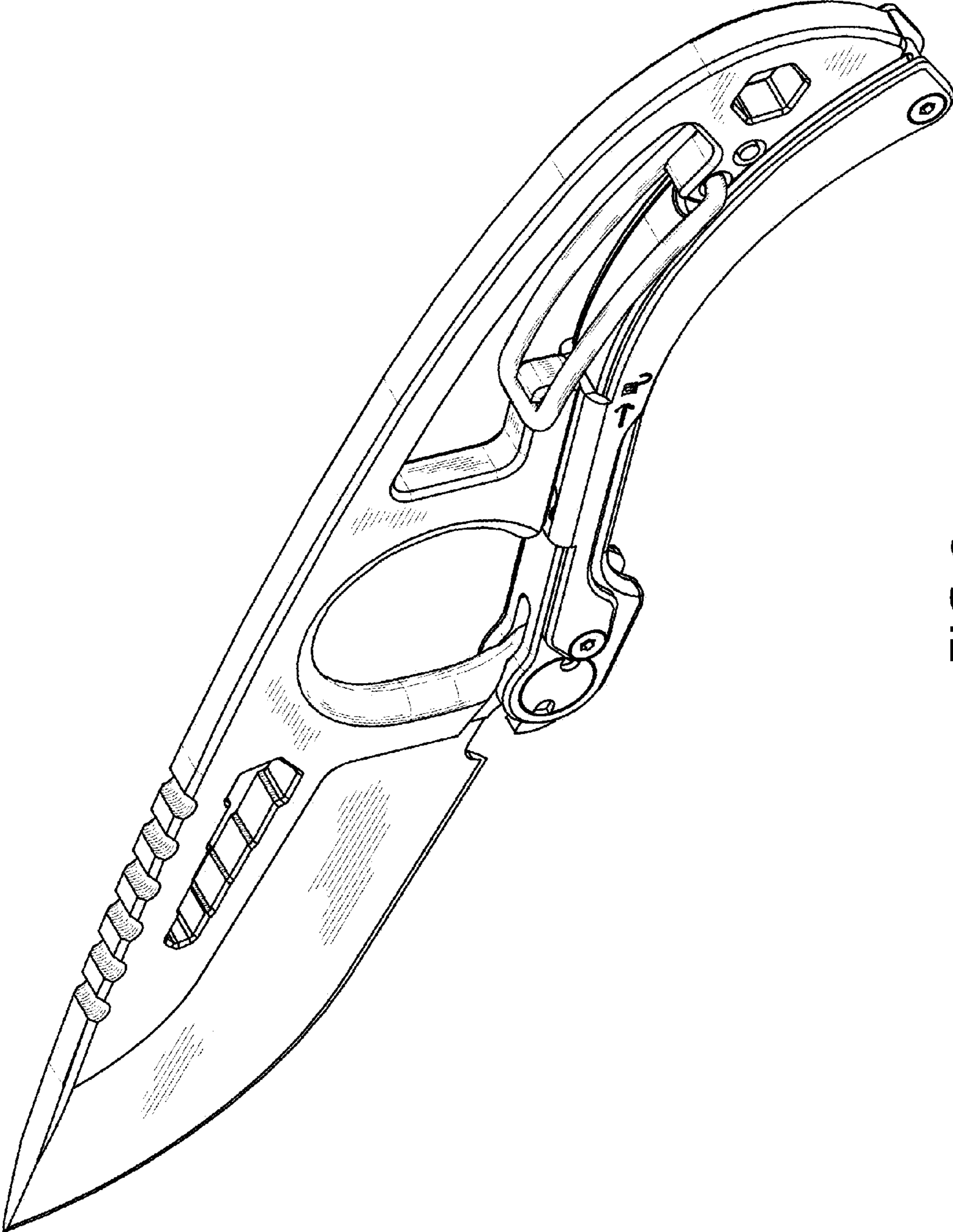

FIG. 3

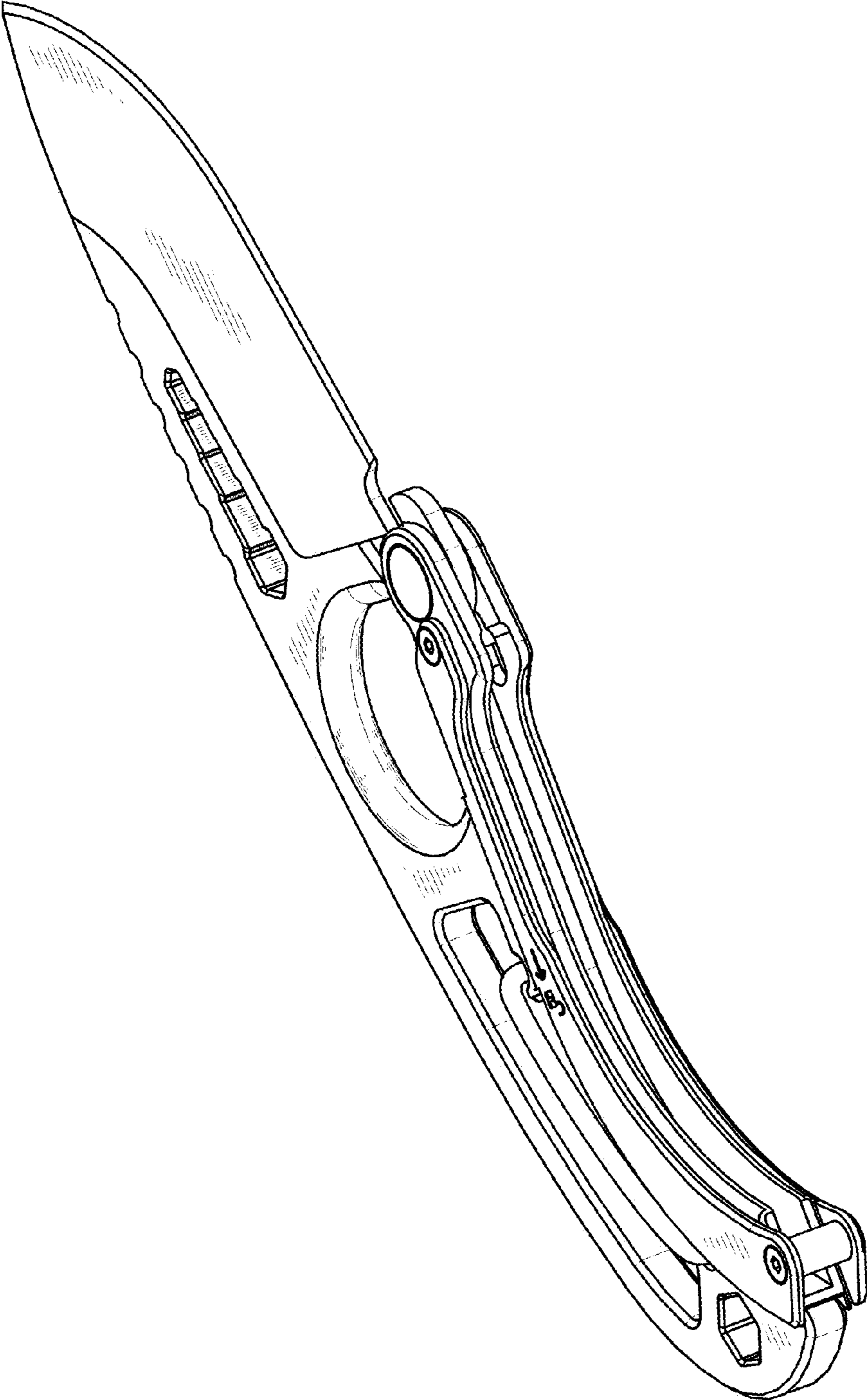

FIG. 4

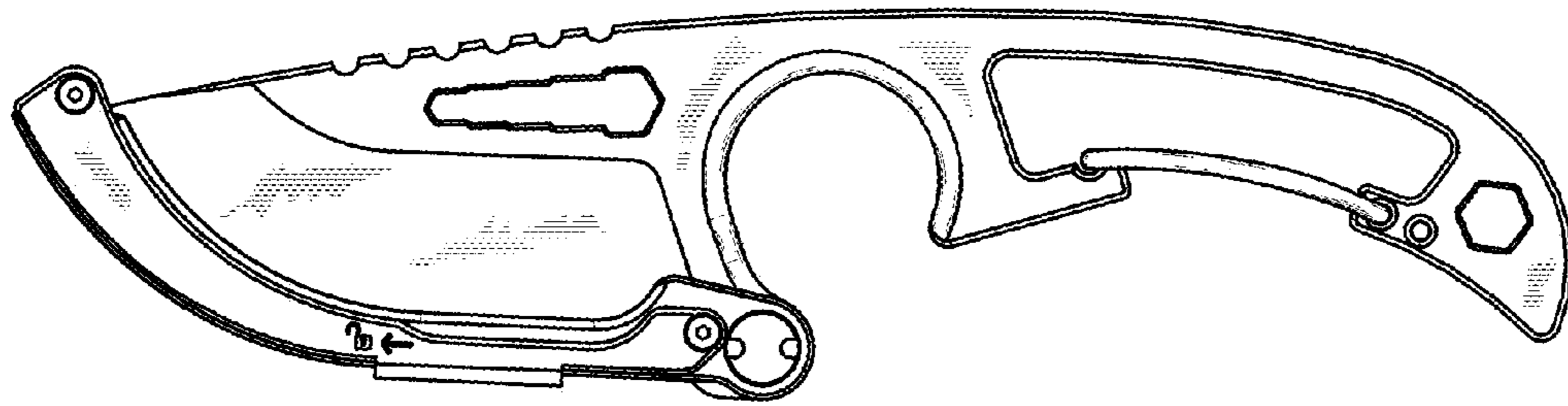

FIG. 5

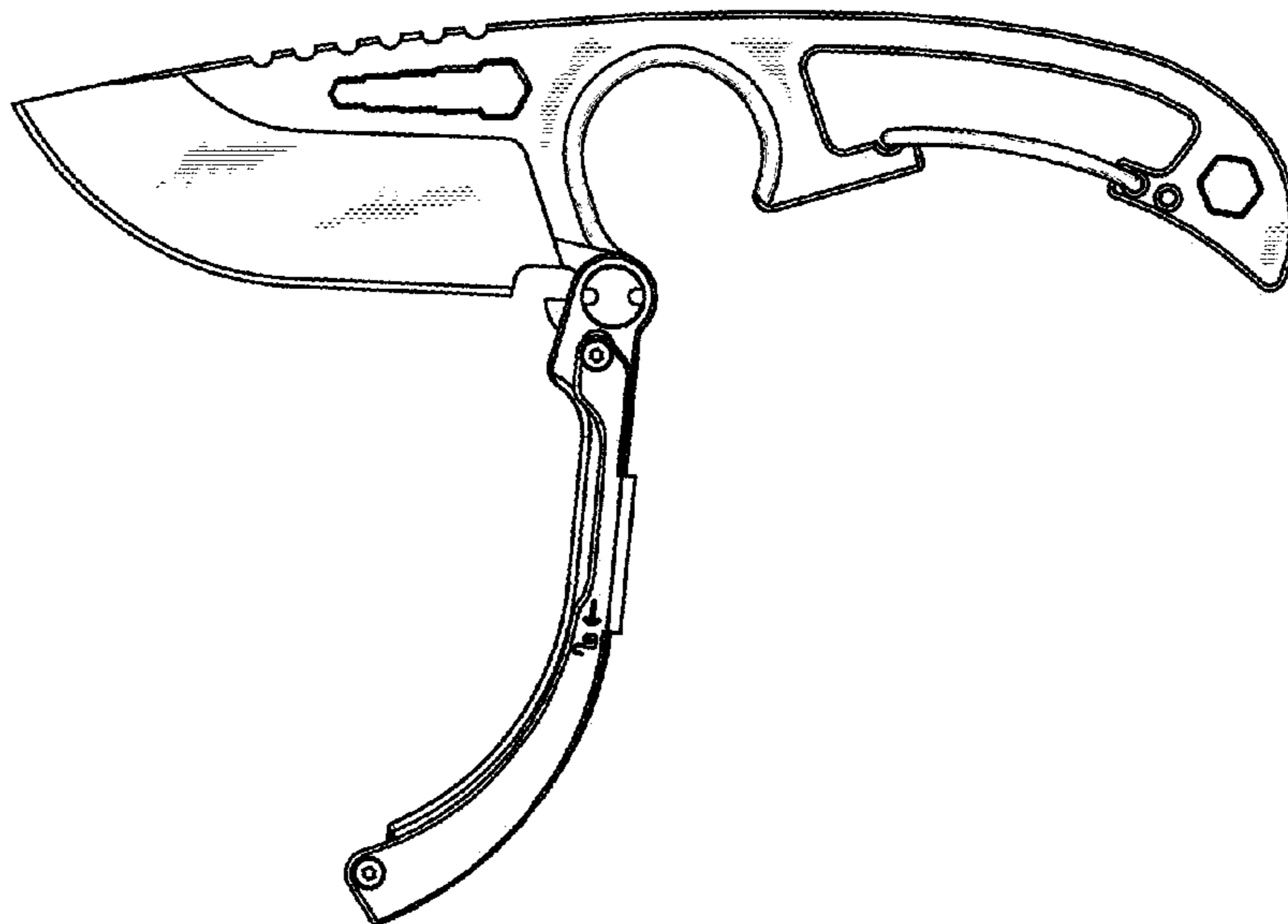

FIG. 6

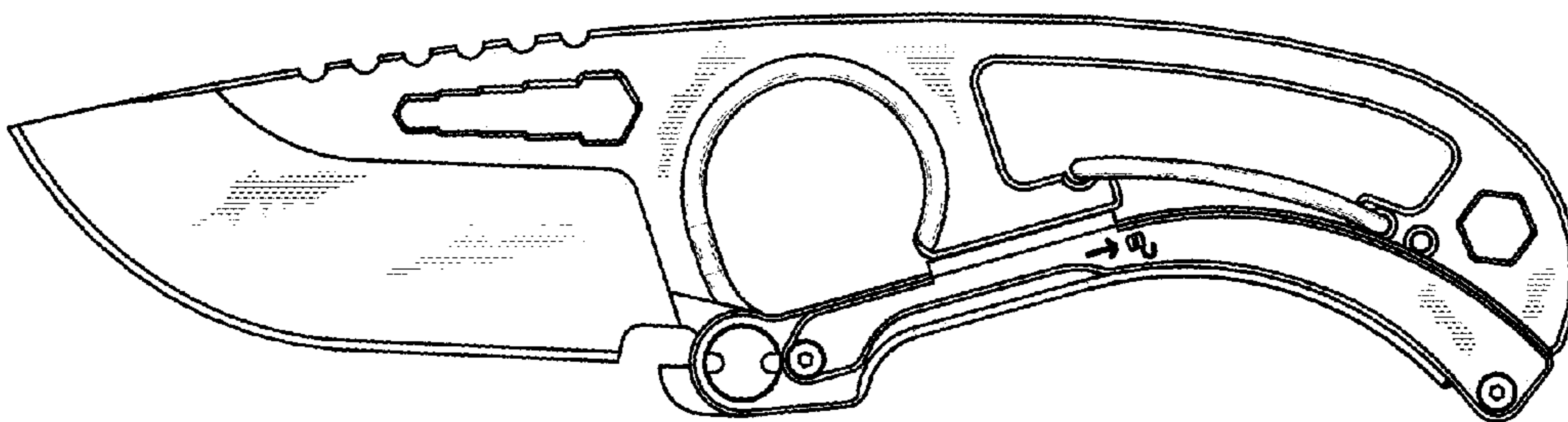

FIG. 7

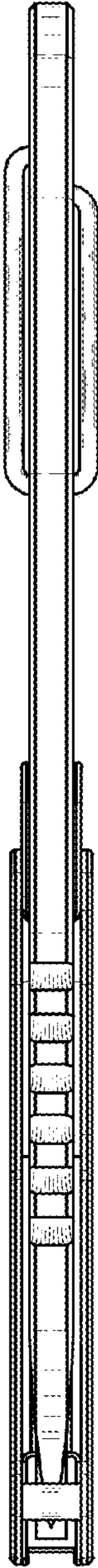

FIG. 8

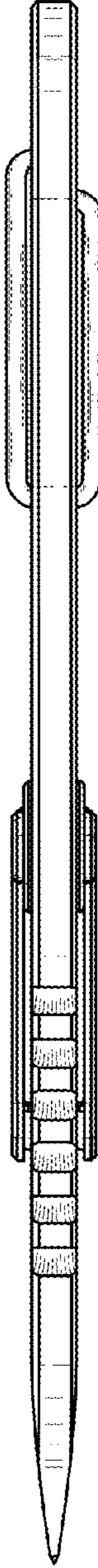

FIG. 9

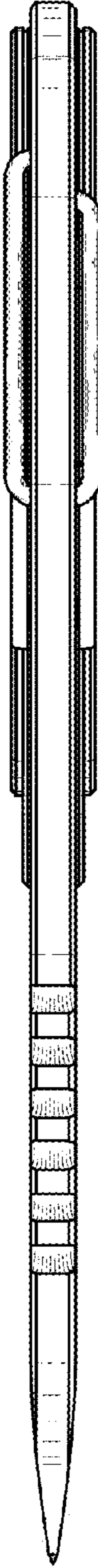

FIG. 10



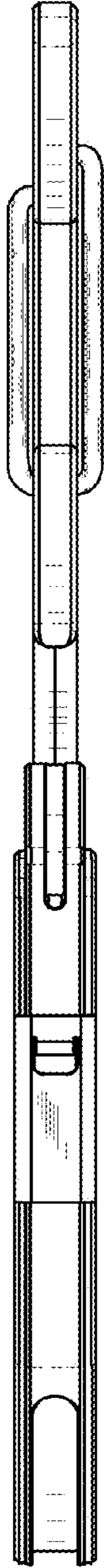

FIG. 11

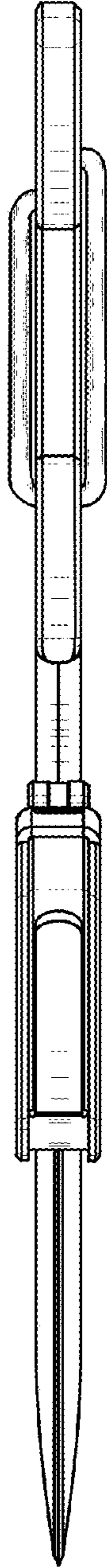

FIG. 12

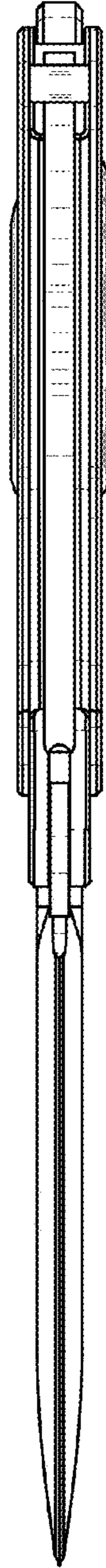

FIG. 13

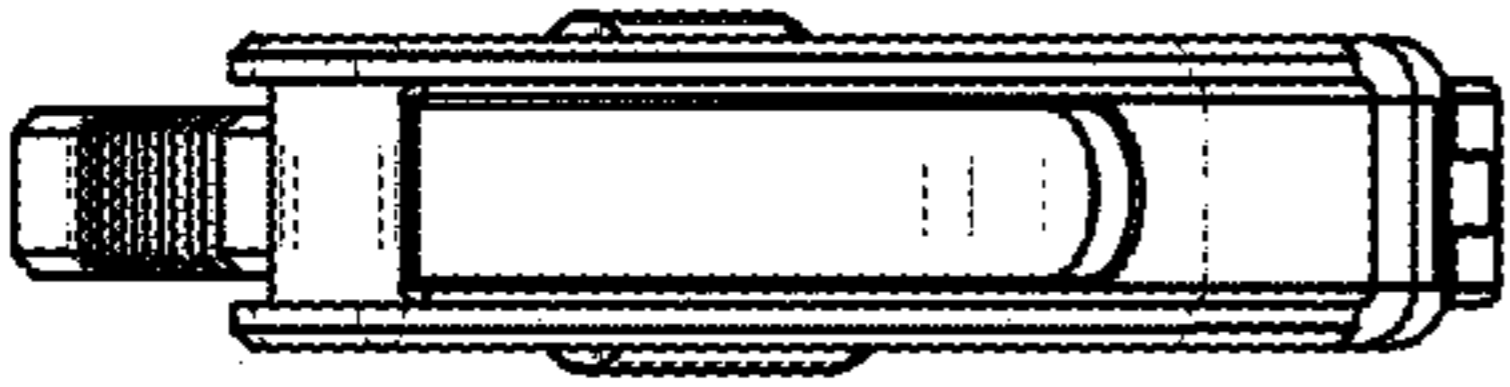

FIG. 14

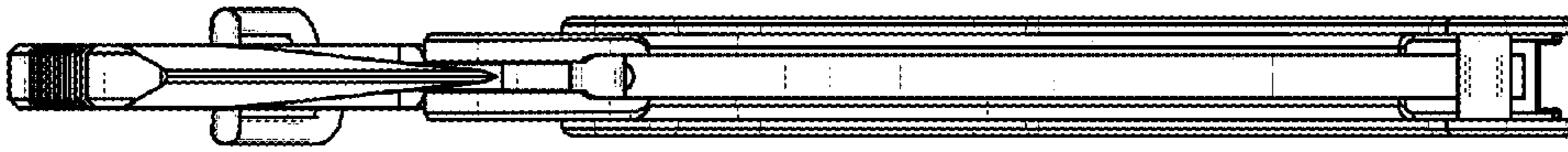

FIG. 15

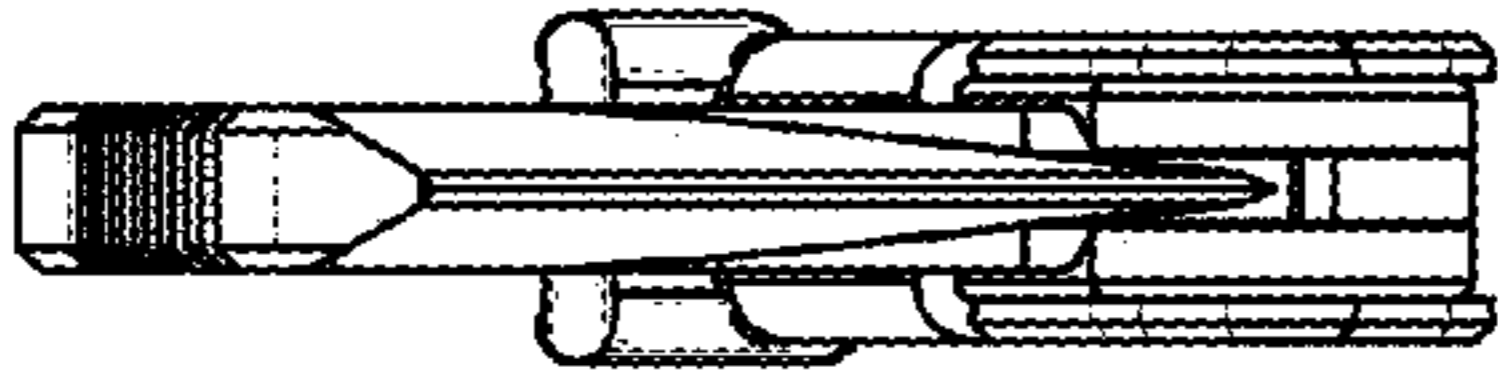

FIG. 16

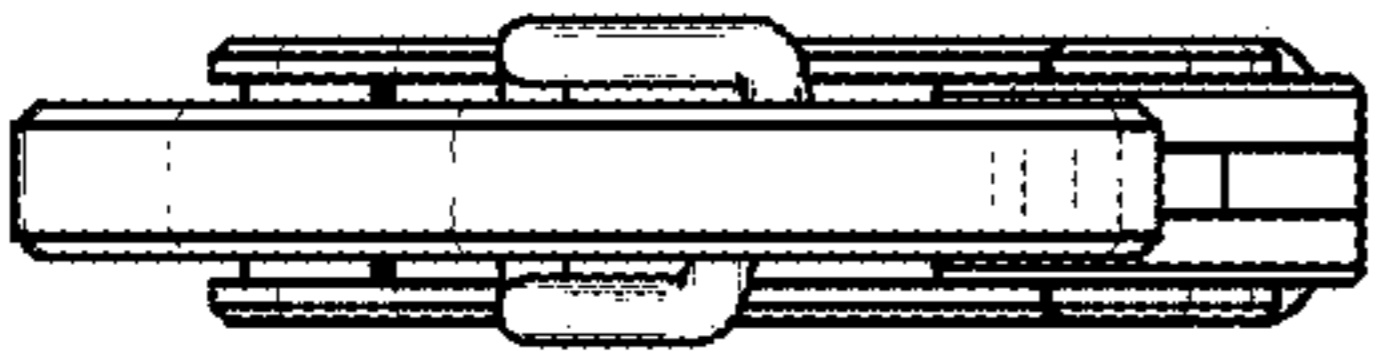

FIG. 17

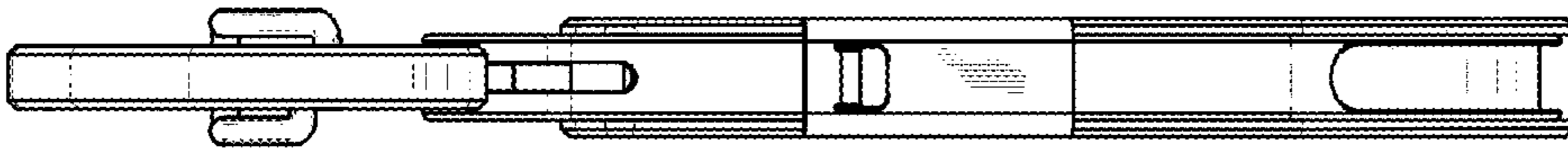

FIG. 18

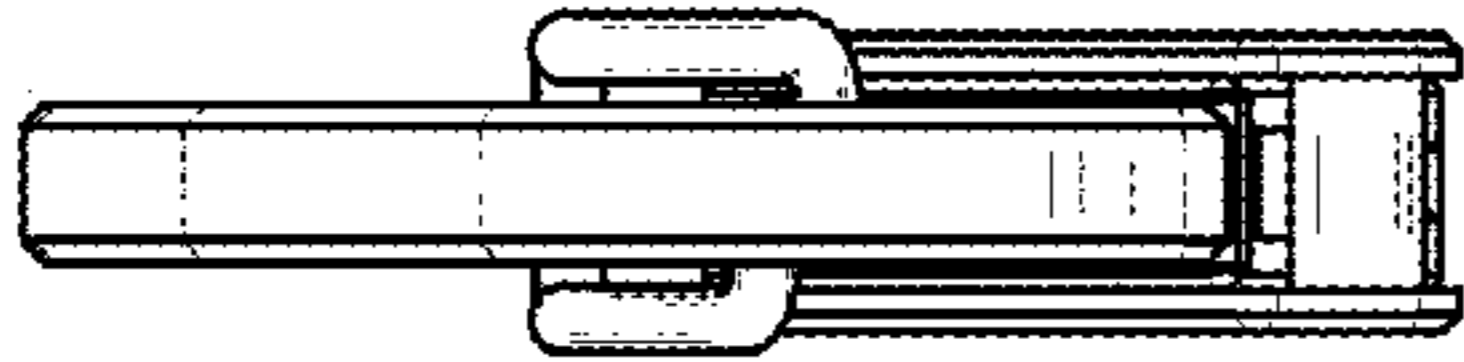

FIG. 19