



US00D746100S

(12) **United States Design Patent**  
**Falcone et al.**

(10) **Patent No.:** **US D746,100 S**  
(45) **Date of Patent:** **\*\* Dec. 29, 2015**

(54) **FOOD WASTE DISPOSER** 3,159,354 A 12/1964 Yartz et al.  
3,163,369 A 12/1964 Hogue  
3,165,271 A \* 1/1965 Enright ..... E03C 1/2665  
241/245  
3,194,505 A \* 7/1965 Spackman ..... E03C 1/2665  
241/188.1  
(71) Applicant: **Emerson Electric Co.**, St. Louis, MO  
(US) 3,236,462 A 2/1966 Stout  
3,246,132 A \* 4/1966 Hans Jordan ..... E03C 1/2665  
241/46.015  
(72) Inventors: **Brian J. Falcone**, Kenosha, WI (US);  
**Amit A. Kumbhar**, Pune (IN) D207,918 S 6/1967 Clark et al.  
3,335,969 A 8/1967 Egle et al.  
D212,127 S 8/1968 Smith et al.  
3,443,764 A 5/1969 Wetzel  
3,534,913 A \* 10/1970 Lawrenson ..... E03C 1/2665  
241/285.2  
(\*\*) Term: **14 Years**  
(21) Appl. No.: **29/500,313** D226,028 S 1/1973 Kennedy et al.  
3,739,992 A 6/1973 Bebinger  
3,814,333 A 6/1974 Sapienza  
3,862,720 A 1/1975 Guth  
3,875,462 A 4/1975 Kiefer et al.  
D237,299 S 10/1975 Pitts et al.  
D237,300 S 10/1975 Pitts  
D237,301 S 10/1975 Pitts  
D237,302 S 10/1975 Pitts  
D237,303 S 10/1975 Pitts  
D237,304 S 10/1975 Pitts  
D237,305 S \* 10/1975 Pitts ..... D7/375  
D237,306 S 10/1975 Pitts  
4,128,210 A 12/1978 Brenner et al.  
4,717,031 A 1/1988 Hewson  
D344,657 S \* 3/1994 Knopp ..... D7/313  
5,340,036 A 8/1994 Riley  
D374,959 S 10/1996 Mull  
5,795,062 A 8/1998 Johnson  
5,856,173 A 1/1999 Riley et al.  
6,007,006 A 12/1999 Engel et al.  
D419,362 S 1/2000 Bouhuys  
D426,421 S 6/2000 Hirsch et al.  
D430,987 S 9/2000 Brandel et al.  
D431,153 S 9/2000 Brandel et al.  
D431,751 S 10/2000 Cahen  
D431,752 S \* 10/2000 Brandel ..... 241/46.013  
D436,496 S 1/2001 Anderson et al.  
D443,792 S 6/2001 Peters et al.  
D451,755 S 12/2001 Brandel et al.  
D452,110 S 12/2001 Brandel et al.  
D454,467 S 3/2002 Magermans et al.  
D455,603 S 4/2002 Brandel et al.  
D455,604 S 4/2002 Brandel et al.  
6,439,487 B1 8/2002 Anderson et al.  
6,481,652 B2 11/2002 Strutz et al.  
D474,365 S 5/2003 Valentino  
D486,797 S 2/2004 Anderson et al.

(58) **Field of Classification Search**  
USPC ..... **D7/375**  
CPC ..... A61L 11/00; B02C 13/00; B02C 13/02;  
B02C 13/04; B02C 13/06; B02C 13/2804;  
B02C 18/00; B02C 18/0076; B02C 18/0084;  
B02C 18/0092; B02C 2013/2808; B02C  
2013/2812; B67D 1/0418; E03C 1/26; E03C  
1/266; E03C 1/2665; E03C 1/28; E03C 1/30;  
E03C 1/302; E03C 1/304  
See application file for complete search history.

(56) **References Cited**  
U.S. PATENT DOCUMENTS

D109,972 S 6/1938 Anderson et al.  
D169,626 S 5/1953 Koslo et al.  
D170,874 S 11/1953 Lambert et al.  
2,750,121 A 6/1956 Schmidt et al.  
D178,854 S 9/1956 Waltman et al.  
2,965,318 A 12/1960 Jordan  
2,978,190 A 4/1961 Brucken et al.  
3,025,007 A 3/1962 Wiczorek  
3,026,050 A 3/1962 Bebinger  
D194,128 S \* 11/1962 Hawkins ..... D7/375  
3,144,213 A \* 8/1964 Hedlund ..... E03C 1/266  
241/46.014

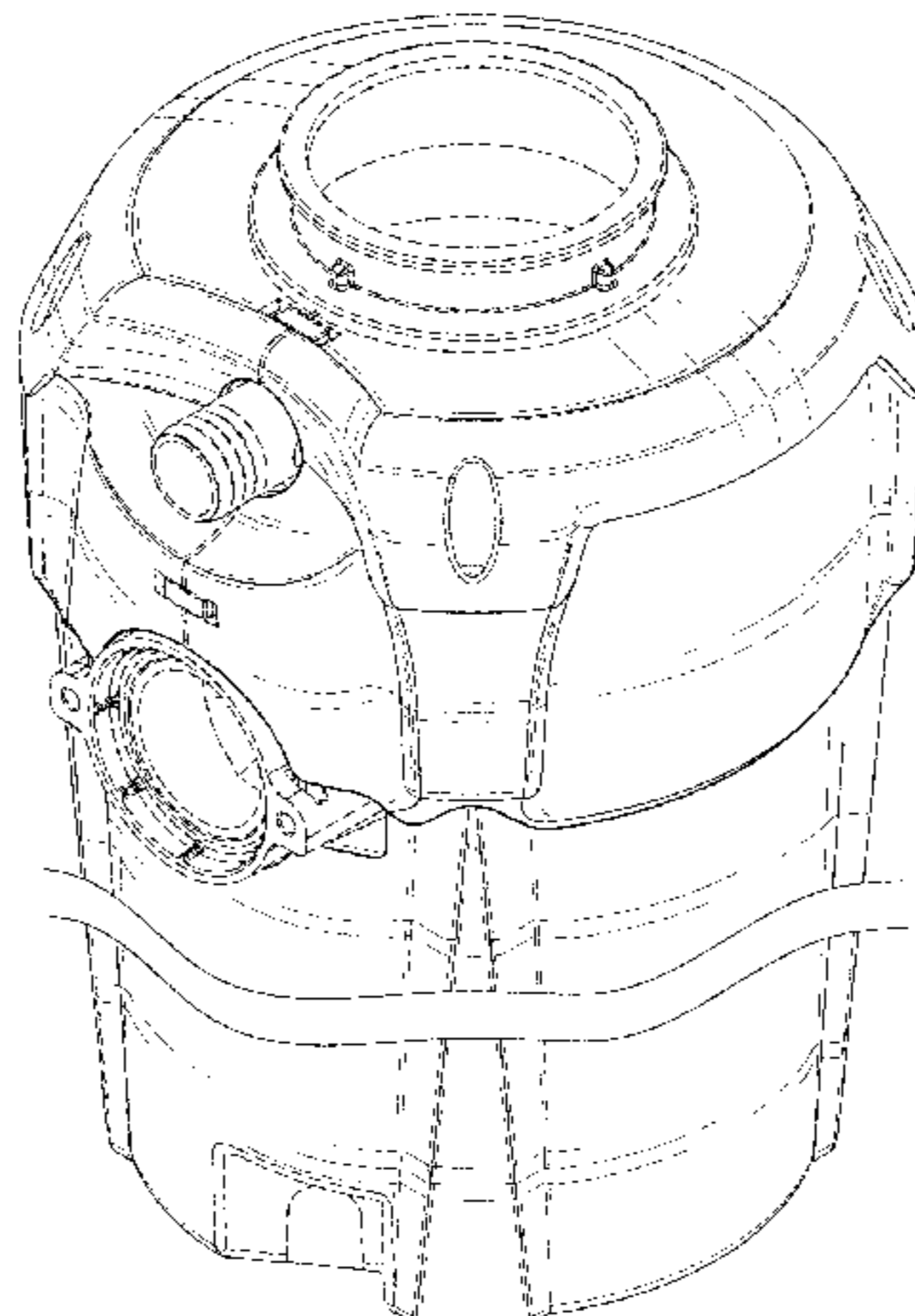

6,783,034	B1 *	8/2004	Brent .....	B67D 1/0418 222/183
7,048,213	B2	5/2006	Strutz et al.	
7,100,850	B2	9/2006	Farmerie	
D534,760	S	1/2007	Patterson et al.	
D534,761	S	1/2007	Patterson et al.	
D535,142	S	1/2007	Patterson et al.	
D535,518	S	1/2007	Patterson et al.	
D535,850	S	1/2007	Patterson et al.	
D536,211	S	2/2007	Jara-Almonte et al.	
D537,673	S	3/2007	Anderson et al.	
D539,078	S	3/2007	Anderson et al.	
D542,594	S	5/2007	Jara-Almonte et al.	
D542,595	S	5/2007	Jara-Almonte et al.	
7,331,539	B2	2/2008	Jara-Almonte et al.	
D588,862	S	3/2009	Saeed et al.	
D593,354	S *	6/2009	Romandy .....	D7/306
7,578,460	B2	8/2009	Berger	
7,654,480	B2	2/2010	Baer et al.	
7,918,411	B2	4/2011	Anderson et al.	
7,963,469	B2	6/2011	Hanson	
7,971,810	B2	7/2011	Hirsch et al.	
D654,302	S	2/2012	Shepherd	
8,146,843	B2	4/2012	Ye et al.	
8,220,731	B2	7/2012	Berger et al.	
D684,003	S	6/2013	Bennage et al.	
D684,004	S	6/2013	Koparde et al.	
D684,005	S	6/2013	Mahale et al.	
D706,572	S *	6/2014	Gamble .....	D7/375
D716,102	S *	10/2014	Morales .....	D7/608
2002/0104909	A1	8/2002	Strutz	
2002/0170990	A1	11/2002	Anderson et al.	
2004/0256506	A1	12/2004	Berger	

FOREIGN PATENT DOCUMENTS

CN	00336359.7	5/2001
CN	3255269	9/2002
CN	3306017	7/2003
CN	3358455	3/2004
CN	3466796	8/2005
CN	301123447	1/2010
CN	301456820	2/2011
CN	301456821	2/2011
CN	301464004	2/2011

OTHER PUBLICATIONS

Photos of insinkerator Badger—444, on sale in the United States earlier than Dec. 1, 2010.  
 Photos of insinkerator Badger—555, on sale in the United States earlier than Dec. 1, 2010.  
 Photos of insinkerator Badger—777, on sale in the United States earlier than Dec. 1, 2010.  
 Photos of insinkerator Badger 5 Plus, on sale in the United States earlier than Dec. 1, 2010.  
 Photos of insinkerator Contractor 333, on sale in the United States earlier than Dec. 1, 2010.  
 Photos of Evergrind E303, on sale in the United States earlier than Dec. 1, 2010.  
 Photos of Evergrind E404, on sale in the United States earlier than Dec. 1, 2010.  
 Insinkerator—“The Practical Idea That Built A Powerful Brand”, Emerson Appliance Solutions—© 2008.  
 Photos of insinkerator Foodservice LC-50, on sale in the United States earlier than Dec. 1, 2010.  
 ShinMaywa Corporation DH150SW, Dec. 1, 2003.  
 White Westinghouse International Series Heavy-Duty Food Waste Disposer, Dec. 2006.  
 GFC1000Y Spec Sheet, Jul. 1997.  
 GFC700Y Spec Sheet, Jul. 1997.  
 GFC705Y Spec Sheet, Jul. 1997.  
 GFC300Y Product Brochure, Jun. 2000.  
 GFC800Y Spec Sheet, Jul. 1997.  
 GFC290Y Spec Sheet, Jul. 1997.  
 GFC295Y Product Brochure, Jun. 2000.

GFB1050V Spec Sheet, Mar. 1996.

\* cited by examiner

Primary Examiner — Ricky Pham

(74) Attorney, Agent, or Firm — Harness, Dickey & Pierce, P.L.C.

(57) CLAIM

The ornamental design for a food waste disposer, as shown and described.

DESCRIPTION

FIG. 1 is a perspective view of a first embodiment of a food waste disposer embodying our new design;  
 FIG. 2 is a front elevational view of the food waste disposer of FIG. 1;  
 FIG. 3 is a rear elevational view of the food waste disposer of FIG. 1;  
 FIG. 4 is a top plan view of the food waste disposer of FIG. 1;  
 FIG. 5 is a bottom plan view of the food waste disposer of FIG. 1;  
 FIG. 6 is a left elevational view of the food waste disposer of FIG. 1; and  
 FIG. 7 is a right elevational view of the food waste disposer of FIG. 1;  
 FIG. 8 is a perspective view of a second embodiment of a food waste disposer embodying our new design;  
 FIG. 9 is a front elevational view of the food waste disposer of FIG. 8;  
 FIG. 10 is a rear elevational view of the food waste disposer of FIG. 8;  
 FIG. 11 is a top plan view of the food waste disposer of FIG. 8;  
 FIG. 12 is a bottom plan view of the food waste disposer of FIG. 8;  
 FIG. 13 is a left elevational view of the food waste disposer of FIG. 8; and  
 FIG. 14 is a right elevational view of the food waste disposer of FIG. 8;  
 FIG. 15 is a perspective view of a third embodiment of a food waste disposer embodying our new design;  
 FIG. 16 is a front elevational view of the food waste disposer of FIG. 15;  
 FIG. 17 is a rear elevational view of the food waste disposer of FIG. 15;  
 FIG. 18 is a top plan view of the food waste disposer of FIG. 15;  
 FIG. 19 is a bottom plan view of the food waste disposer of FIG. 15;  
 FIG. 20 is a left elevational view of the food waste disposer of FIG. 15; and  
 FIG. 21 is a right elevational view of the food waste disposer of FIG. 15;  
 FIG. 22 is a perspective view of a fourth embodiment of a food waste disposer embodying our new design;  
 FIG. 23 is a front elevational view of the food waste disposer of FIG. 22;  
 FIG. 24 is a rear elevational view of the food waste disposer of FIG. 22;  
 FIG. 25 is a top plan view of the food waste disposer of FIG. 22;  
 FIG. 26 is a bottom plan view of the food waste disposer of FIG. 22;



FIG. 27 is a left elevational view of the food waste disposer of FIG. 22; and

FIG. 28 is a right elevational view of the food waste disposer of FIG. 22;

FIG. 29 is a perspective view of a fifth embodiment of a food waste disposer embodying our new design;

FIG. 30 is a front elevational view of the food waste disposer of FIG. 29;

FIG. 31 is a rear elevational view of the food waste disposer of FIG. 29;

FIG. 32 is a top plan view of the food waste disposer of FIG. 29;

FIG. 33 is a bottom plan view of the food waste disposer of FIG. 29;

FIG. 34 is a left elevational view of the food waste disposer of FIG. 29; and

FIG. 35 is a right elevational view of the food waste disposer of FIG. 29;

FIG. 36 is a perspective view of a sixth embodiment of a food waste disposer embodying our new design;

FIG. 37 is a front elevational view of the food waste disposer of FIG. 36;

FIG. 38 is a rear elevational view of the food waste disposer of FIG. 36;

FIG. 39 is a top plan view of the food waste disposer of FIG. 36;

FIG. 40 is a bottom plan view of the food waste disposer of FIG. 36;

FIG. 41 is a left elevational view of the food waste disposer of FIG. 36; and

FIG. 42 is a right elevational view of the food waste disposer of FIG. 36;

FIG. 43 is a perspective view of a seventh embodiment of a food waste disposer embodying our new design;

FIG. 44 is a front elevational view of the food waste disposer of FIG. 43;

FIG. 45 is a rear elevational view of the food waste disposer of FIG. 43;

FIG. 46 is a top plan view of the food waste disposer of FIG. 43;

FIG. 47 is a bottom plan view of the food waste disposer of FIG. 43;

FIG. 48 is a left elevational view of the food waste disposer of FIG. 43; and

FIG. 49 is a right elevational view of the food waste disposer of FIG. 43;

FIG. 50 is a perspective view of an eighth embodiment of a food waste disposer embodying our new design;

FIG. 51 is a front elevational view of the food waste disposer of FIG. 50;

FIG. 52 is a rear elevational view of the food waste disposer of FIG. 50;

FIG. 53 is a top plan view of the food waste disposer of FIG. 50;

FIG. 54 is a bottom plan view of the food waste disposer of FIG. 50;

FIG. 55 is a left elevational view of the food waste disposer of FIG. 50; and,

FIG. 56 is a right elevational view of the food waste disposer of FIG. 50.

The broken lines in all views are for the purpose of illustration and are not part of the claimed design. The pairs of broken-away wavy lines in the various perspective, front, rear, left and right elevational views indicate that the motor cover has no particular height and such pairs of wavy lines themselves form no part of the claimed design.

**1 Claim, 56 Drawing Sheets**

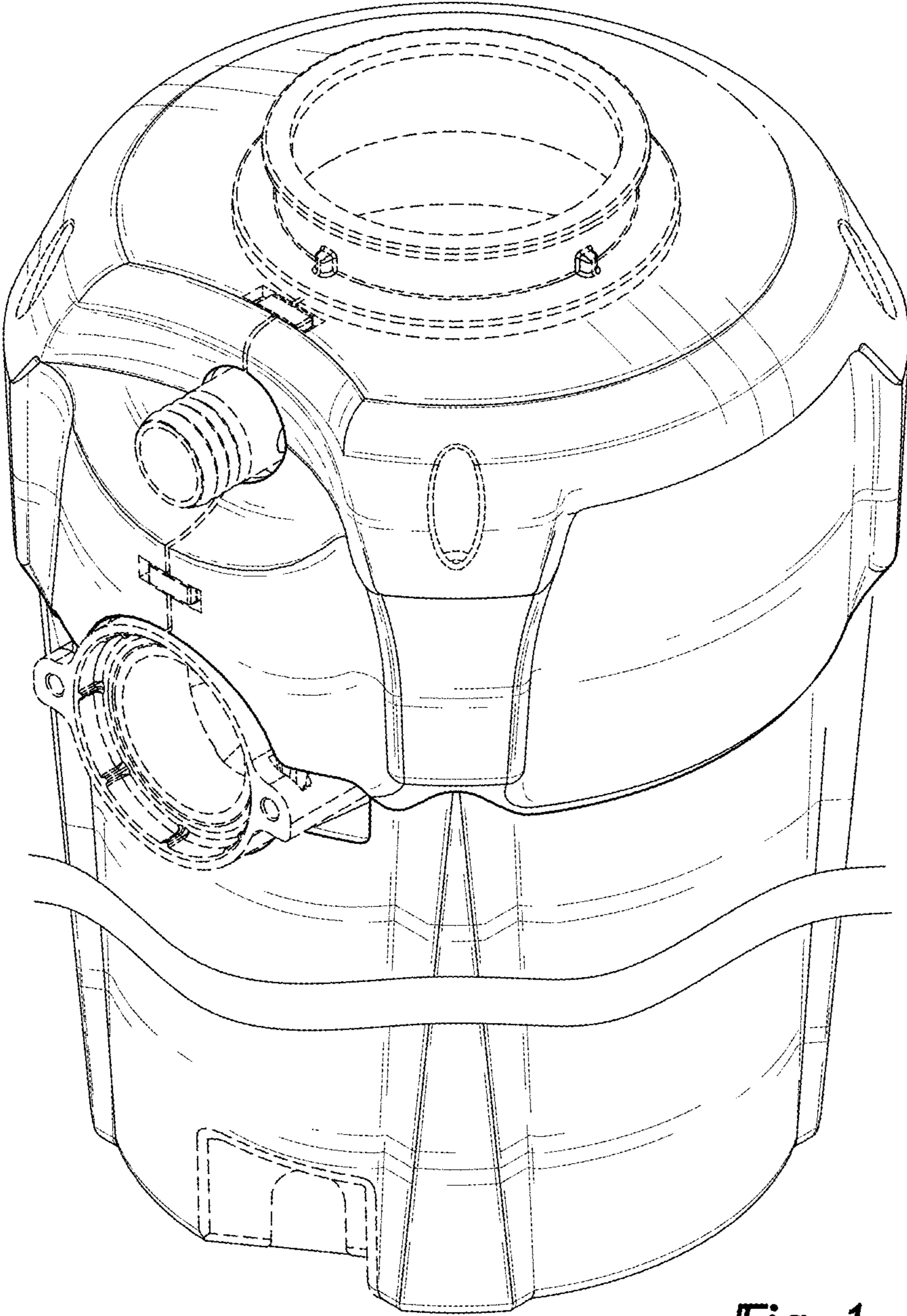

Fig-1

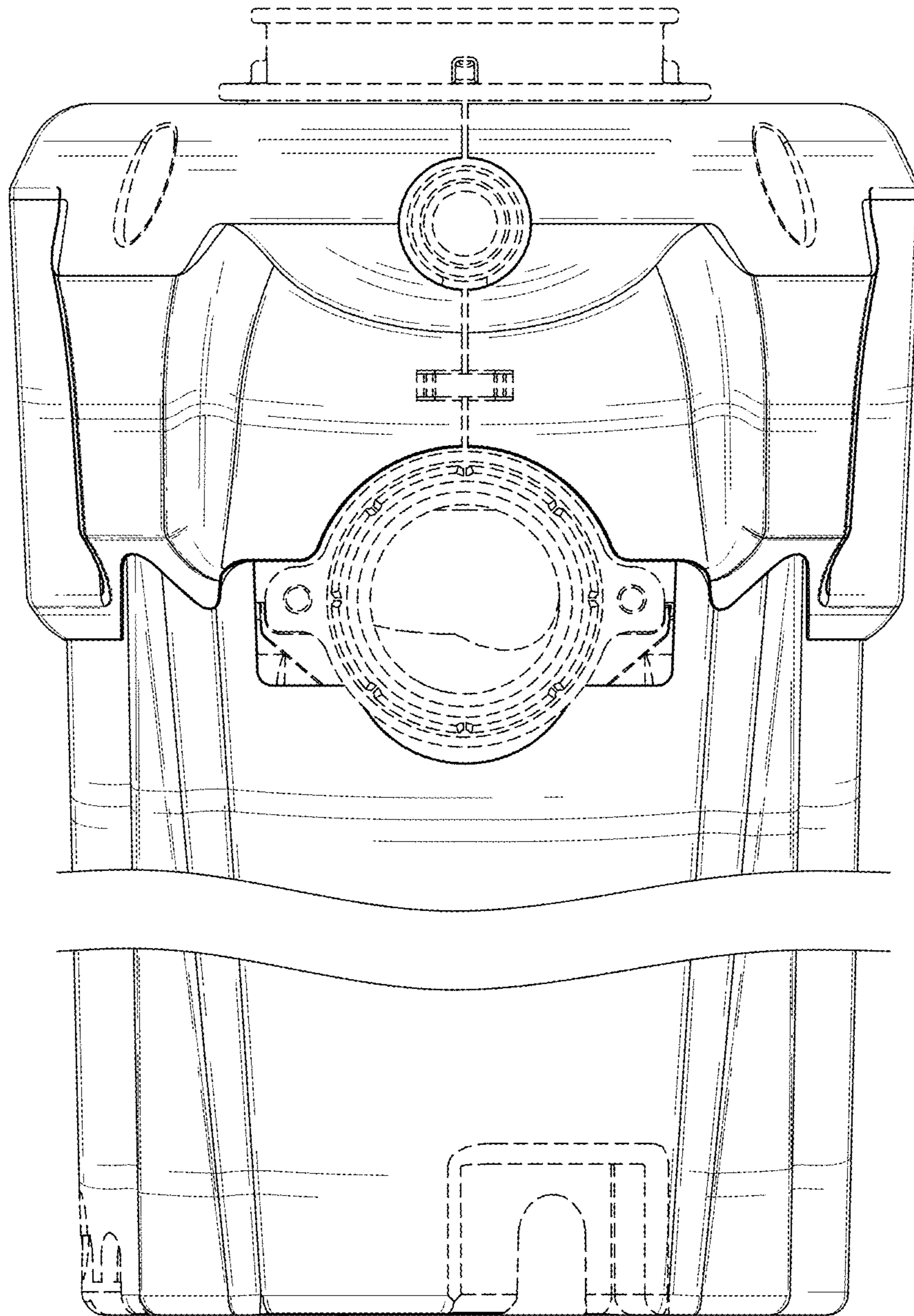

Fig-2



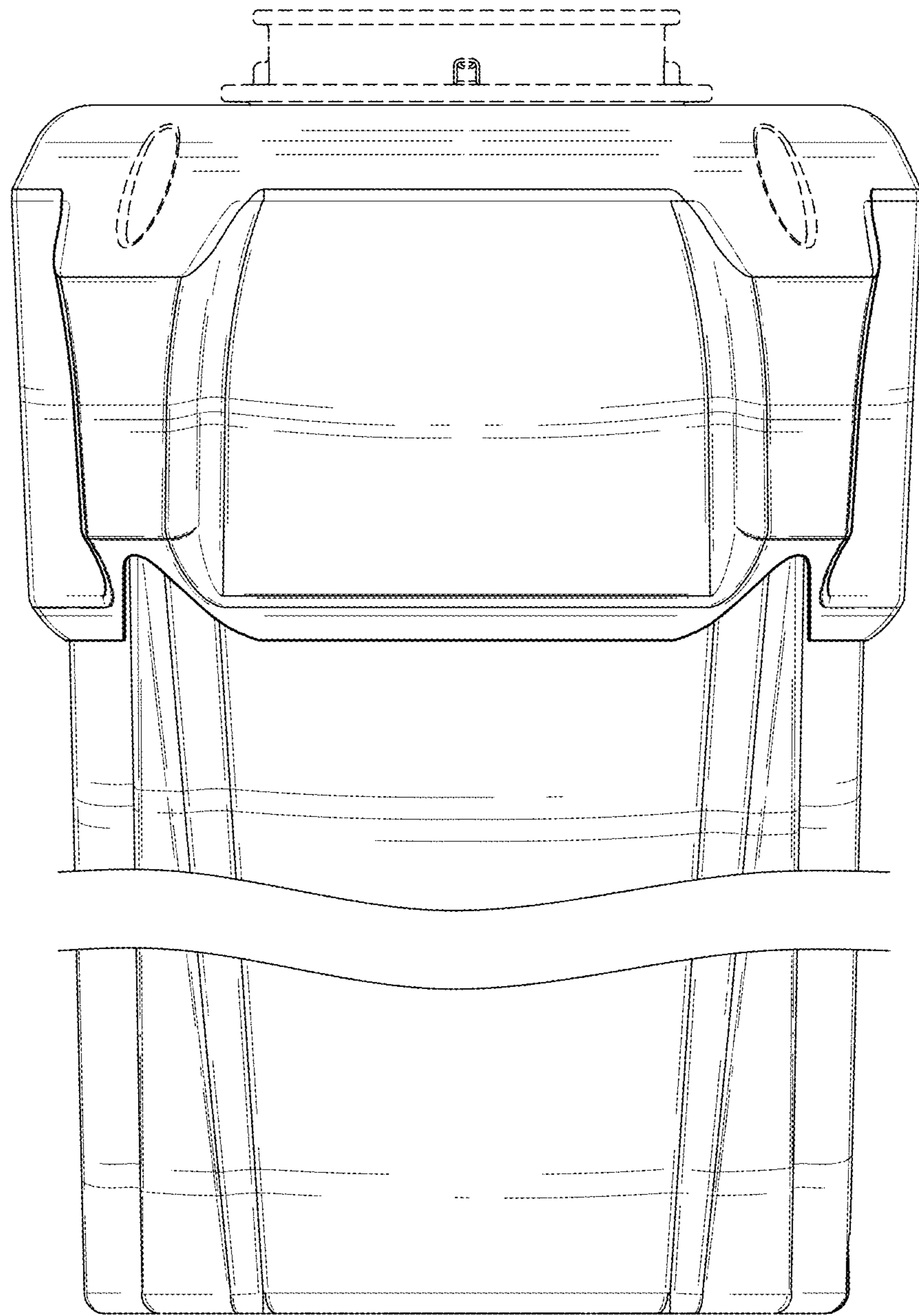

Fig-3

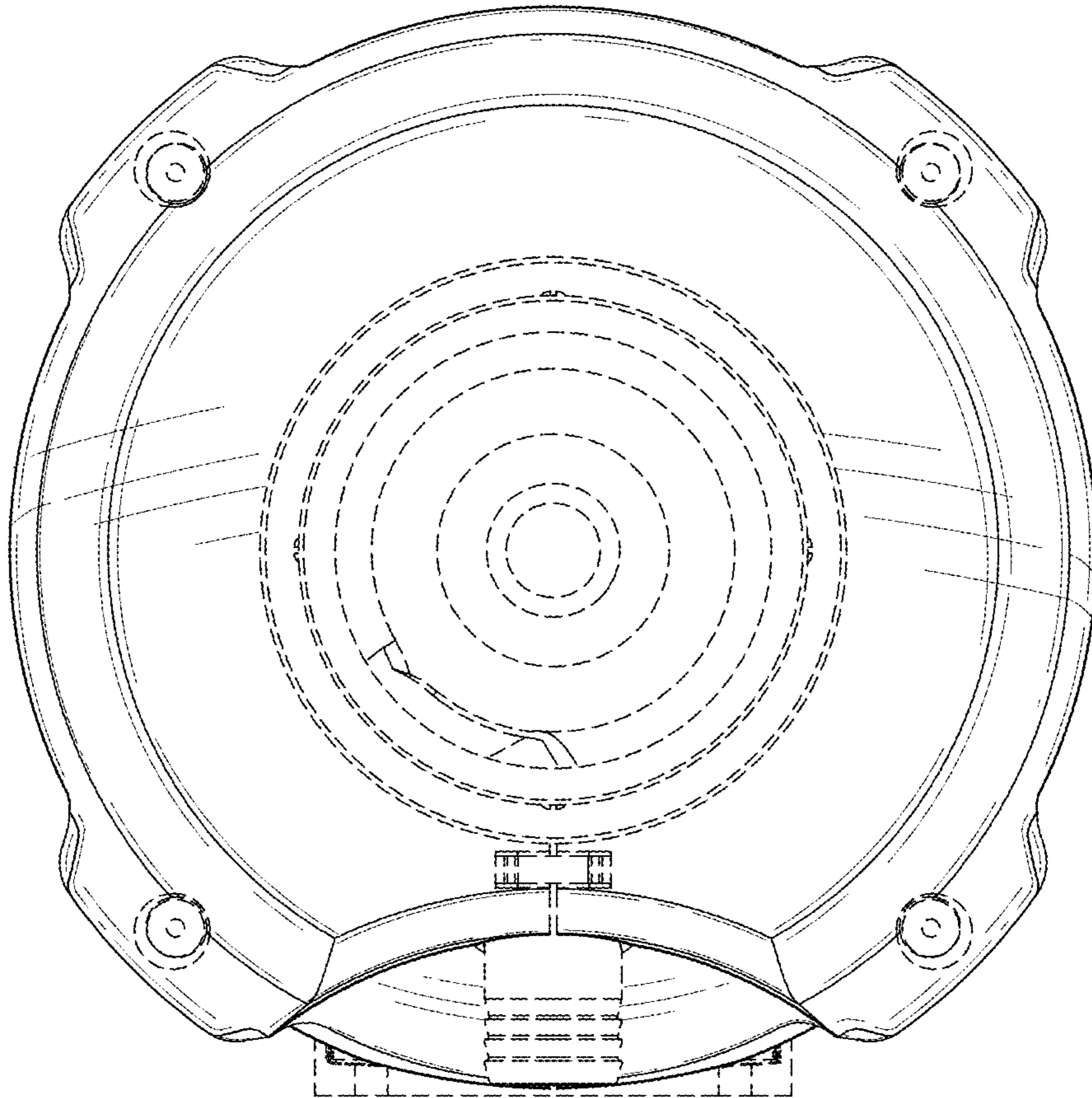

Fig-4

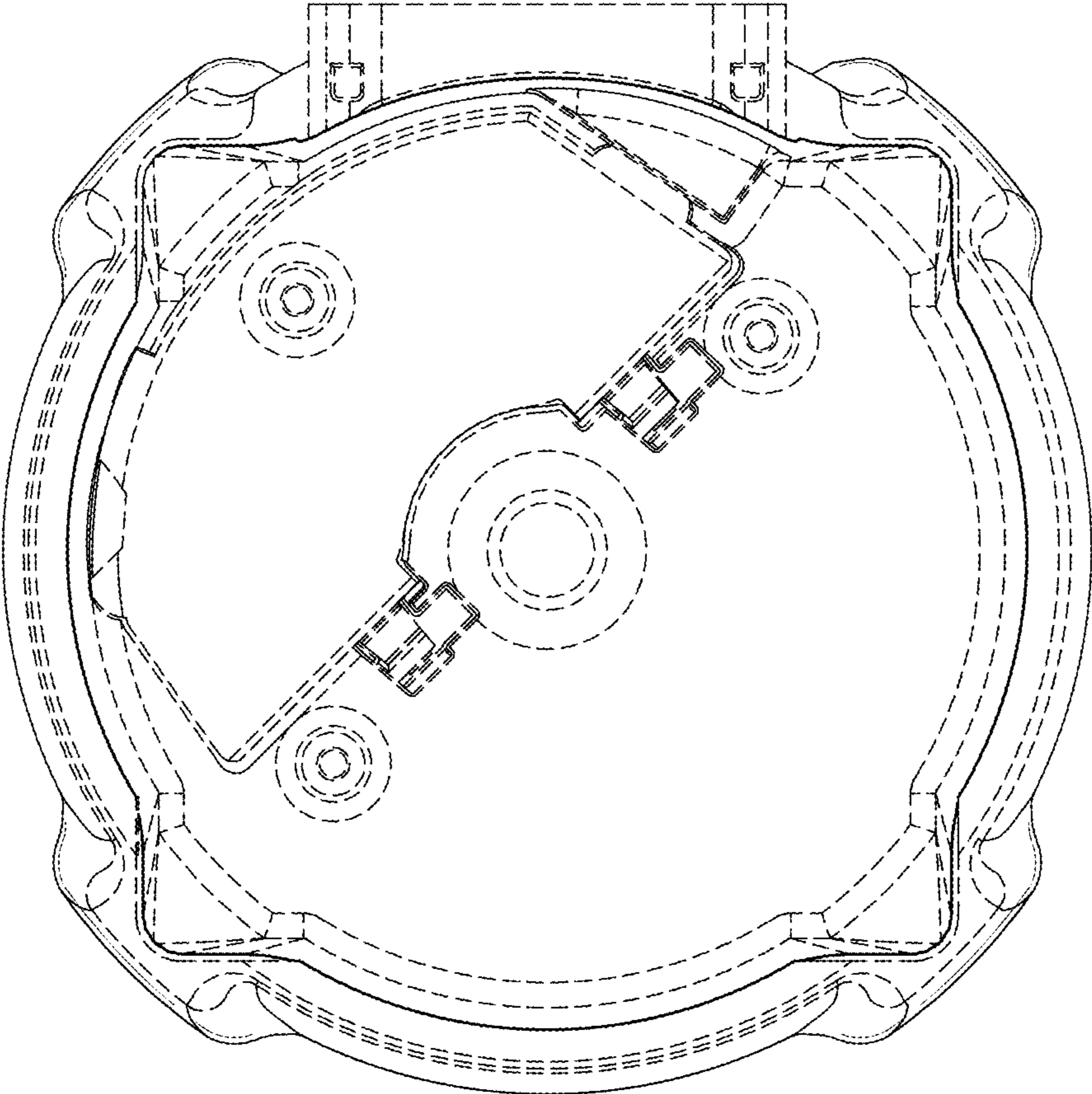

Fig-5



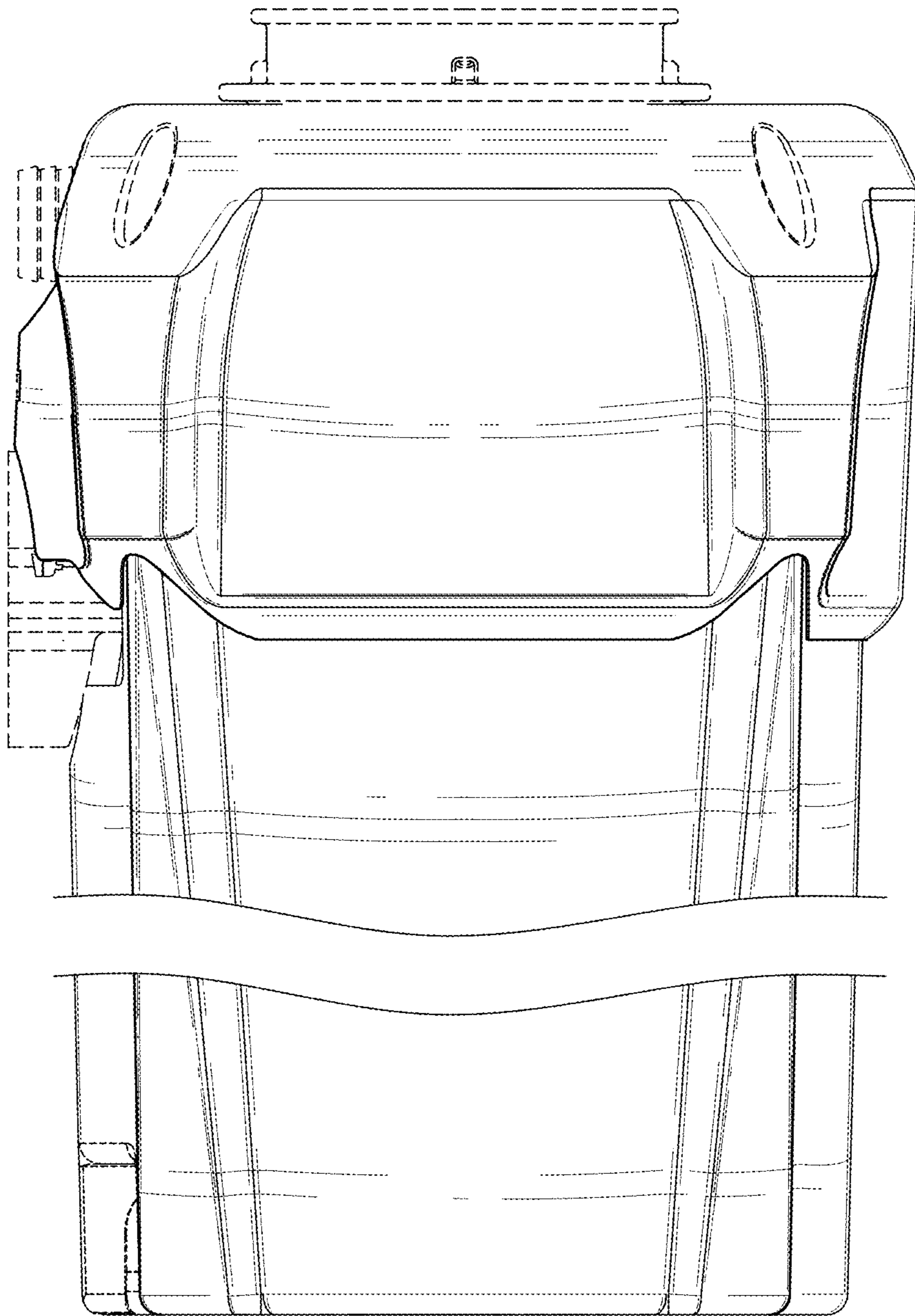

Fig-6

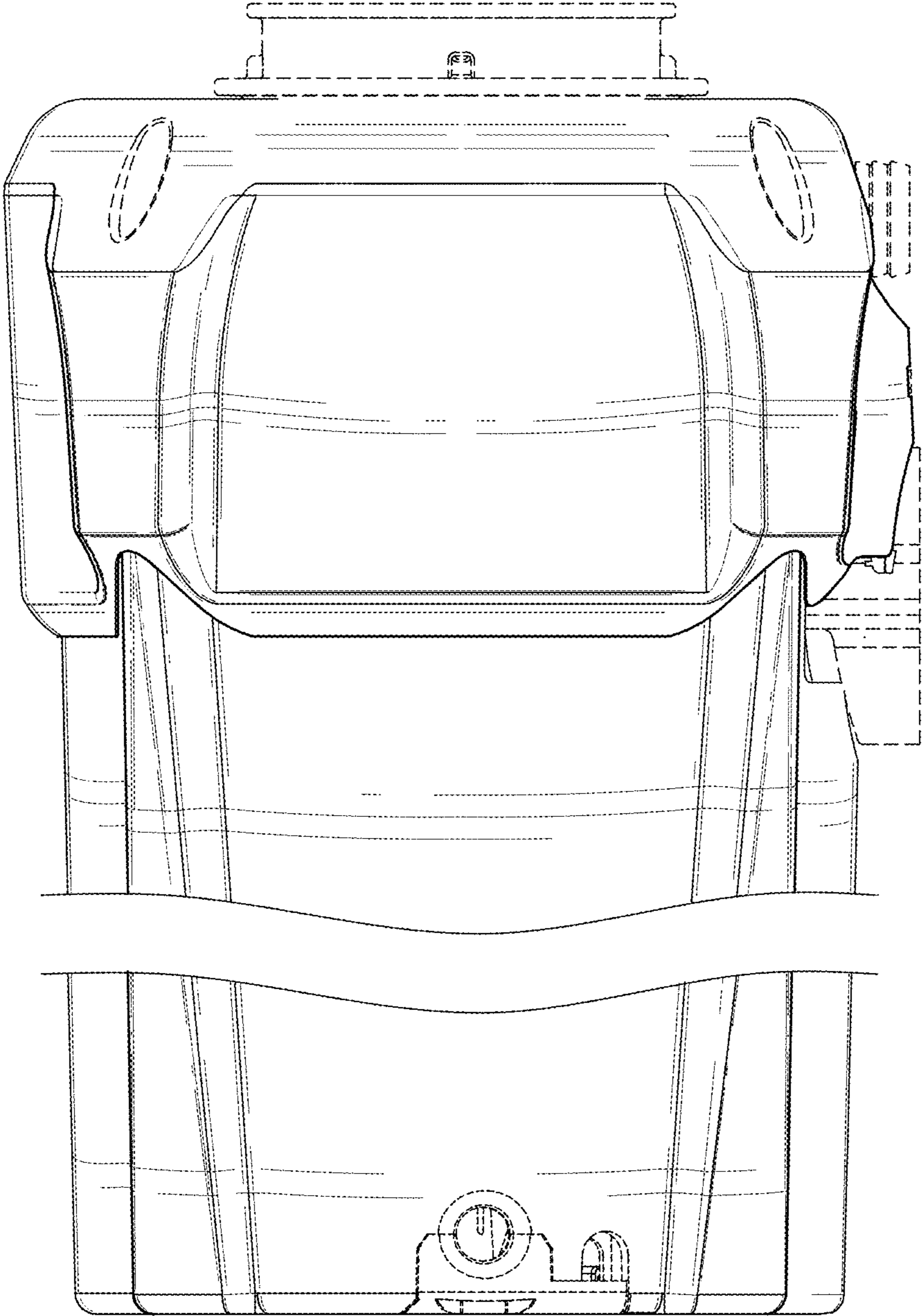

Fig-7

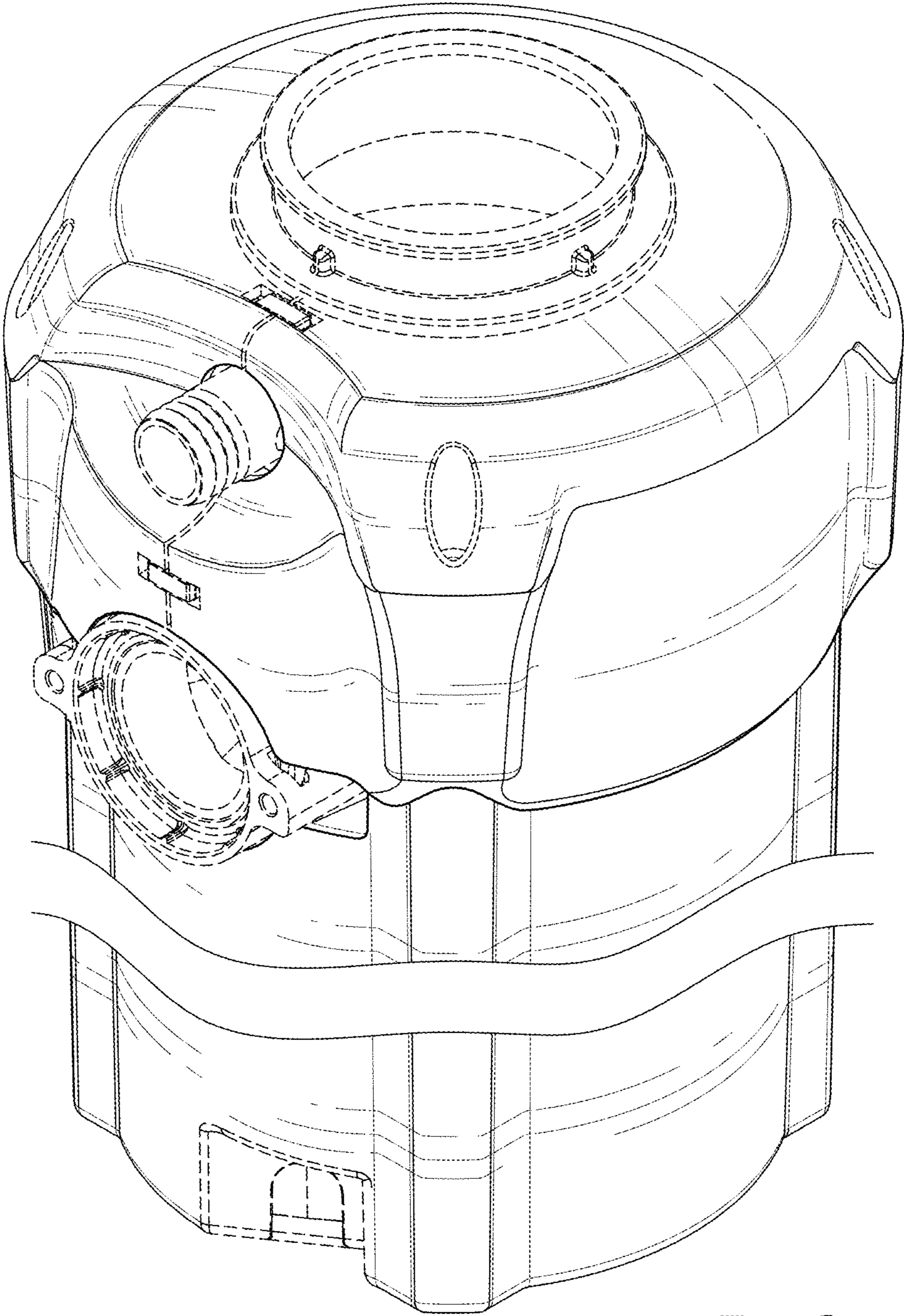

Fig-8



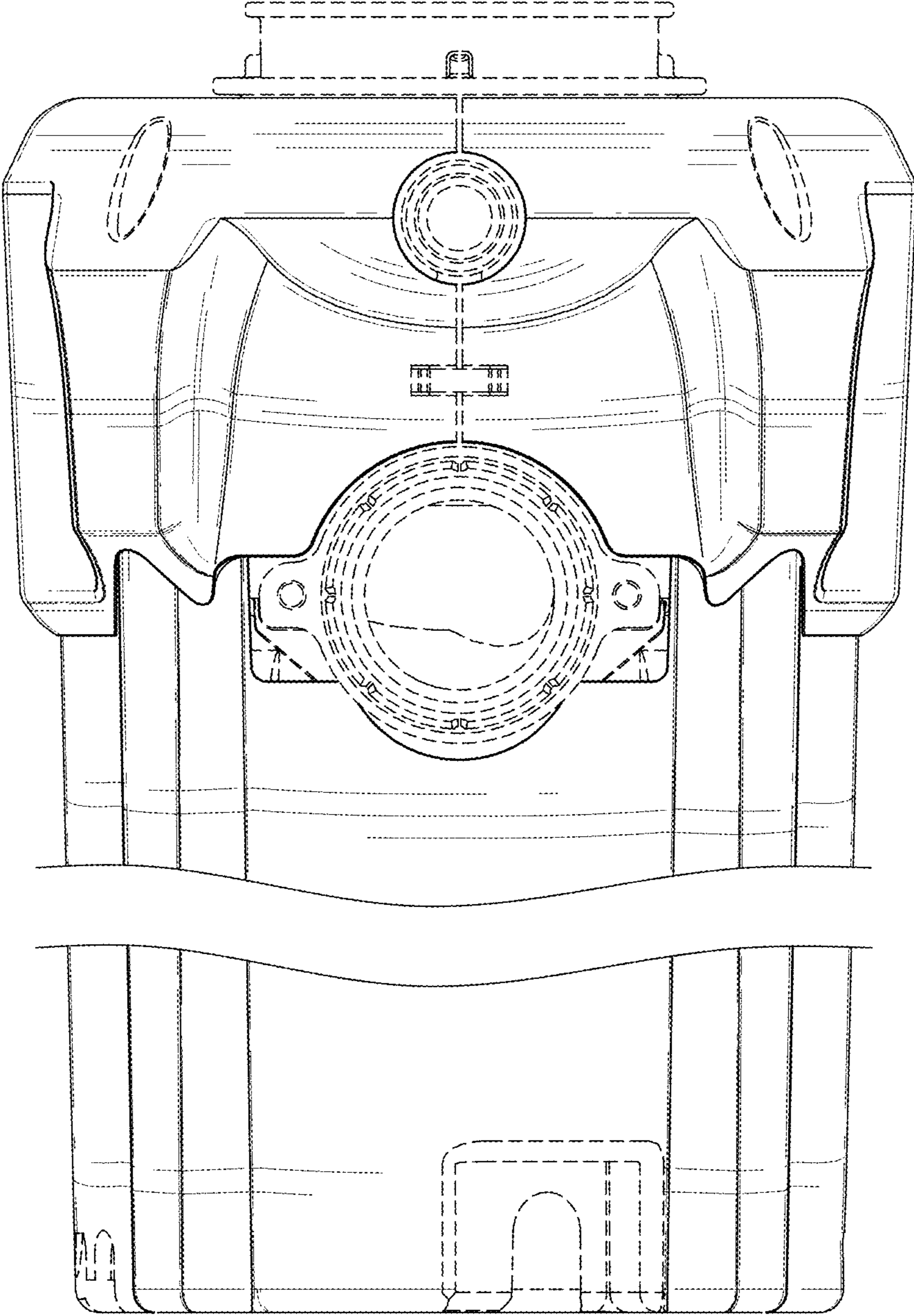

Fig-9

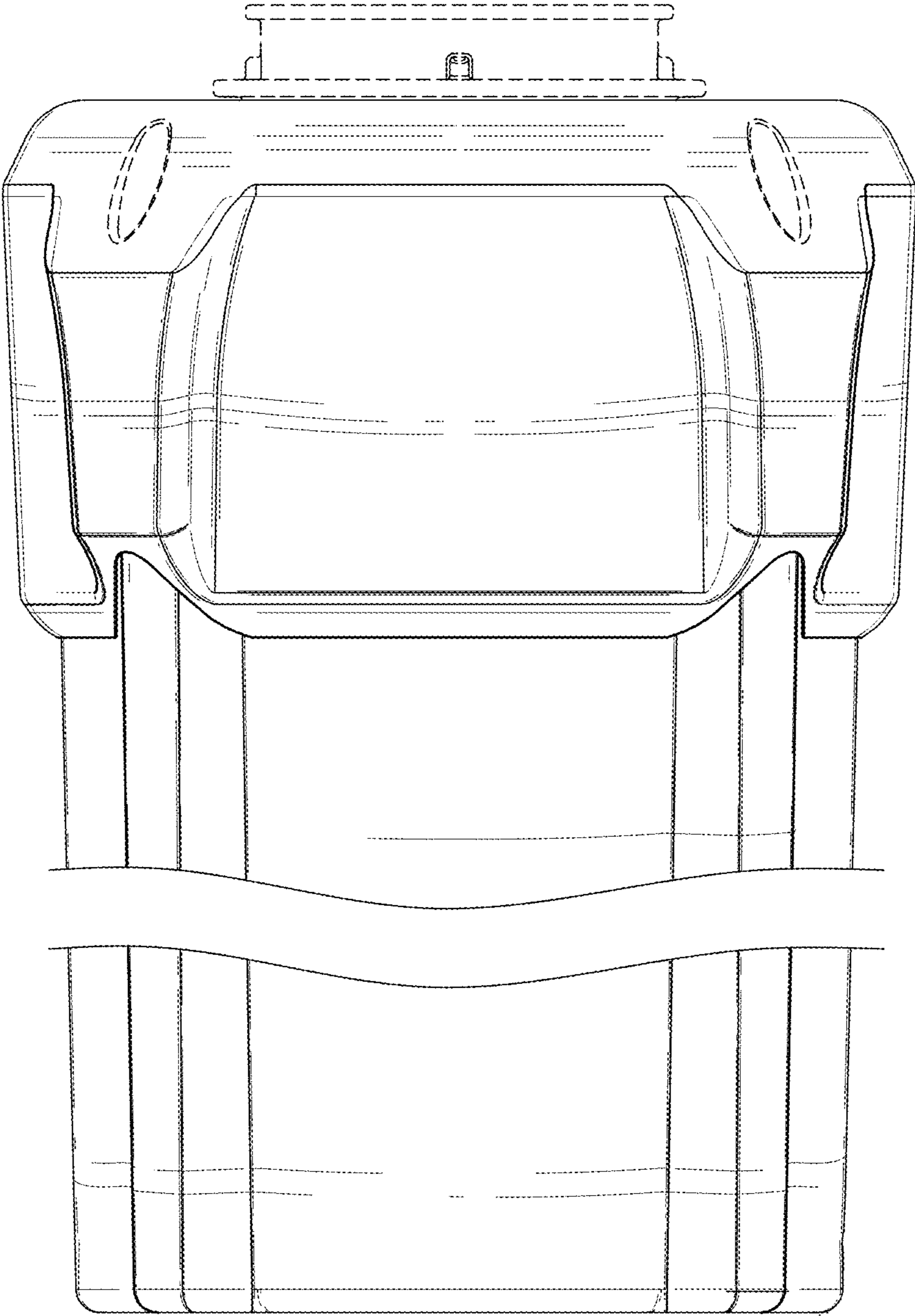

Fig-10

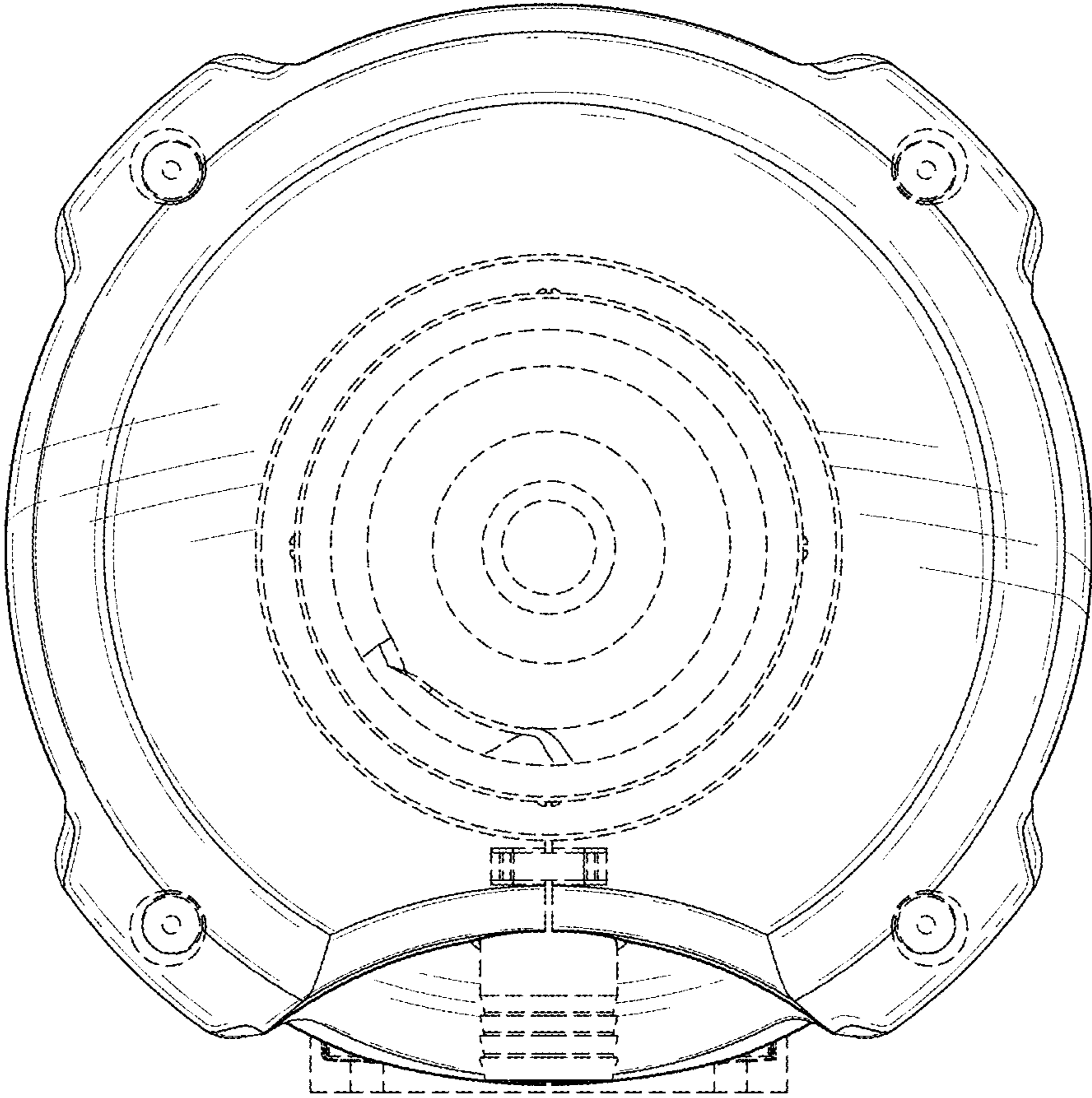

Fig-11



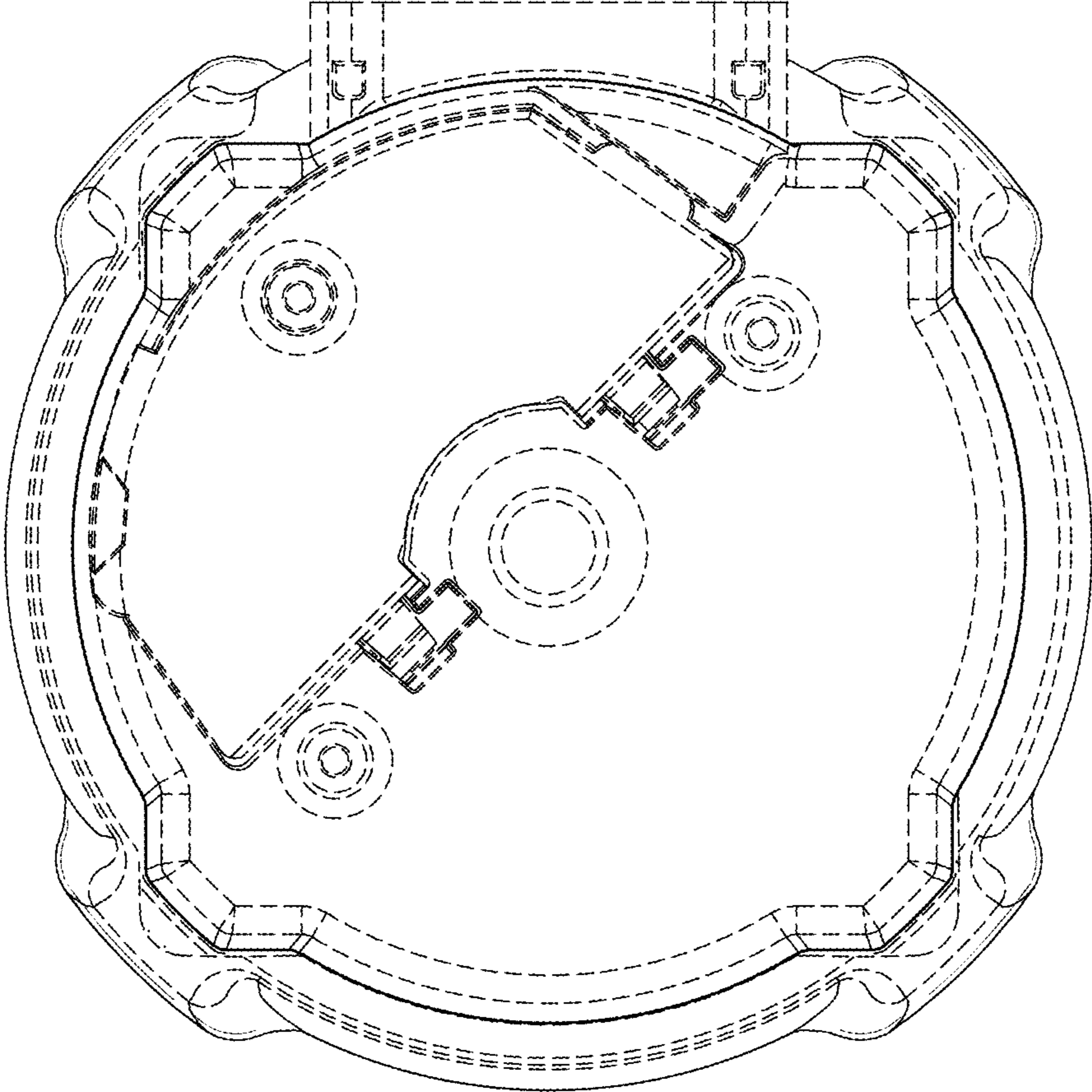

Fig-12

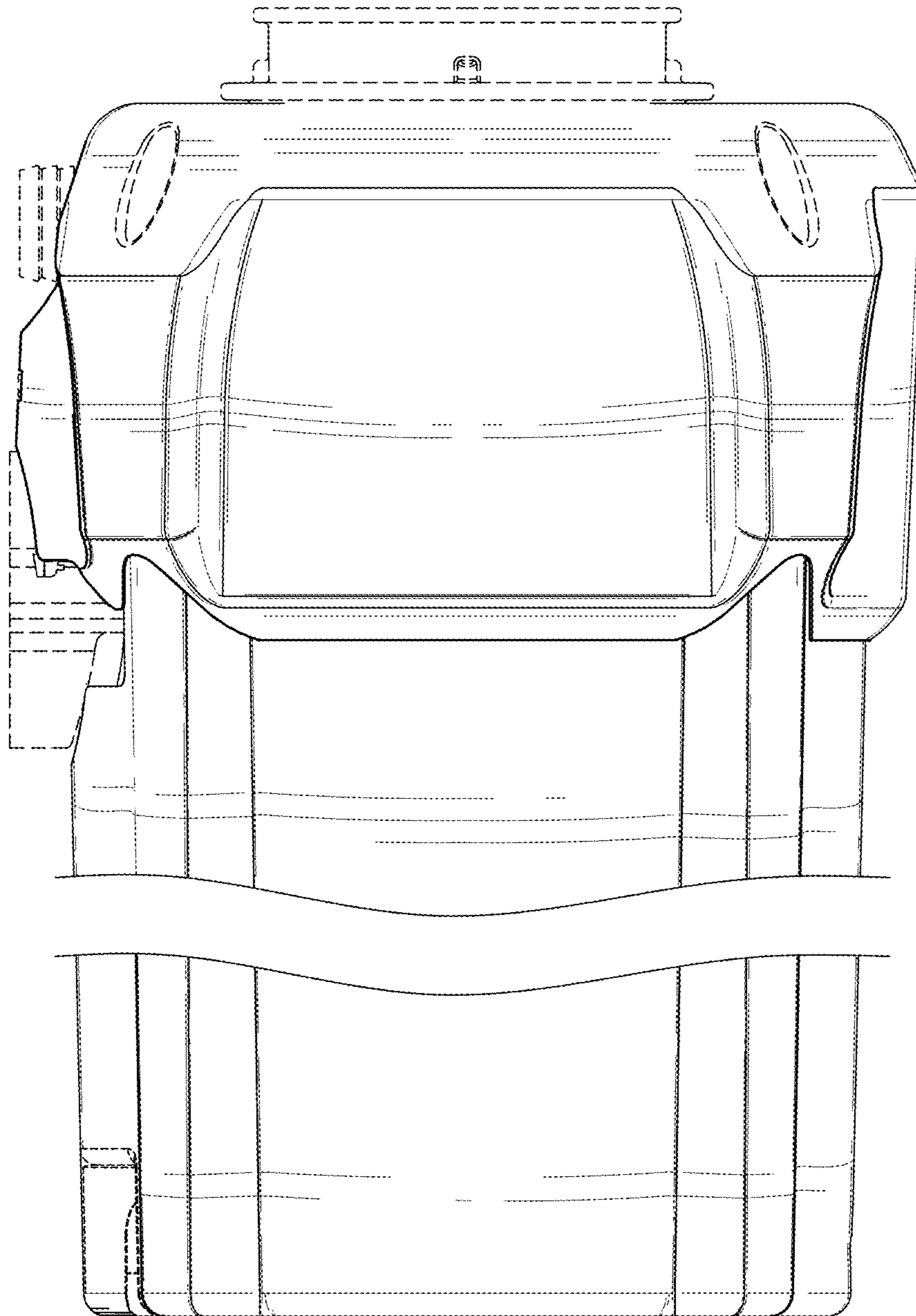

Fig-13

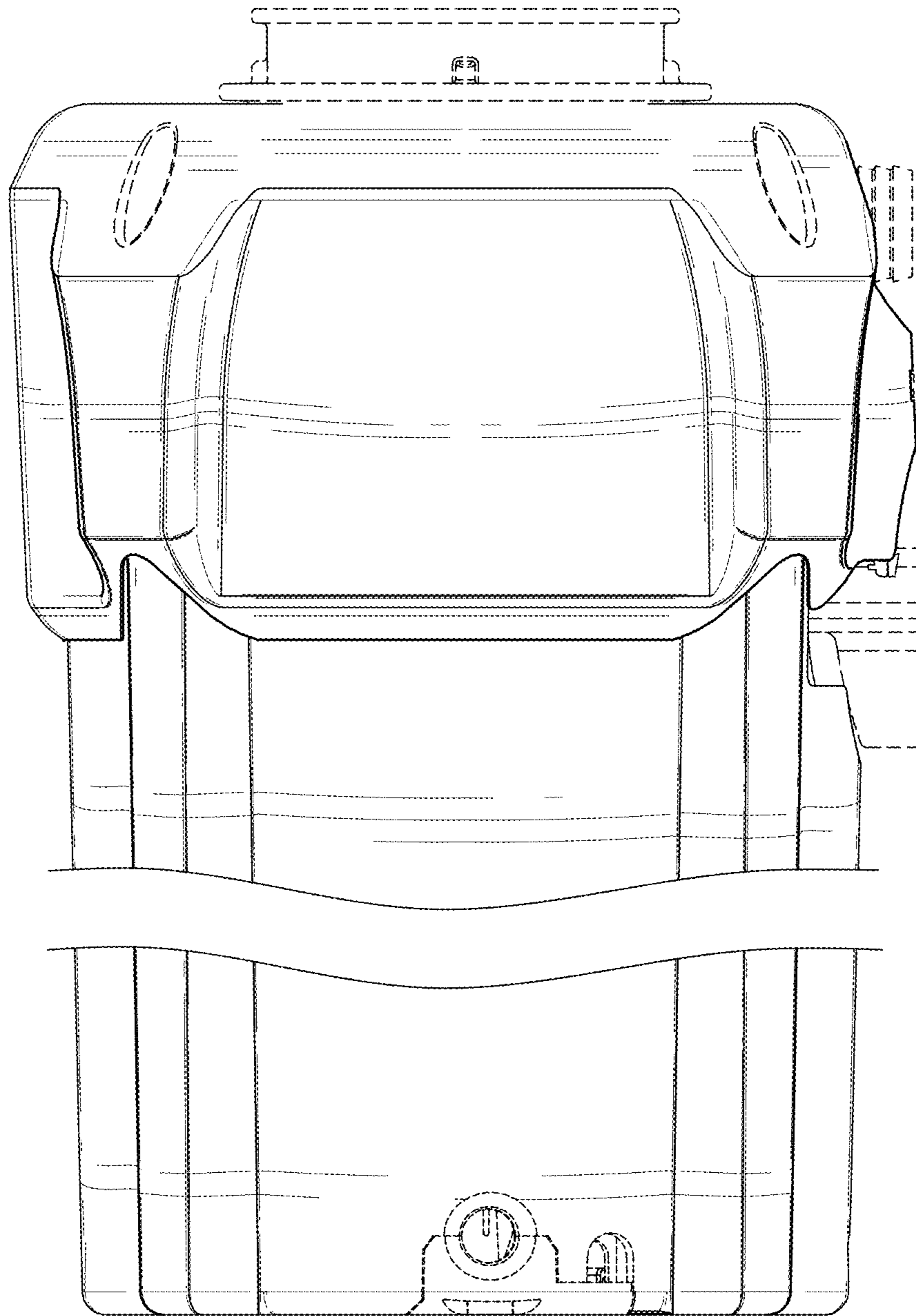

Fig-14



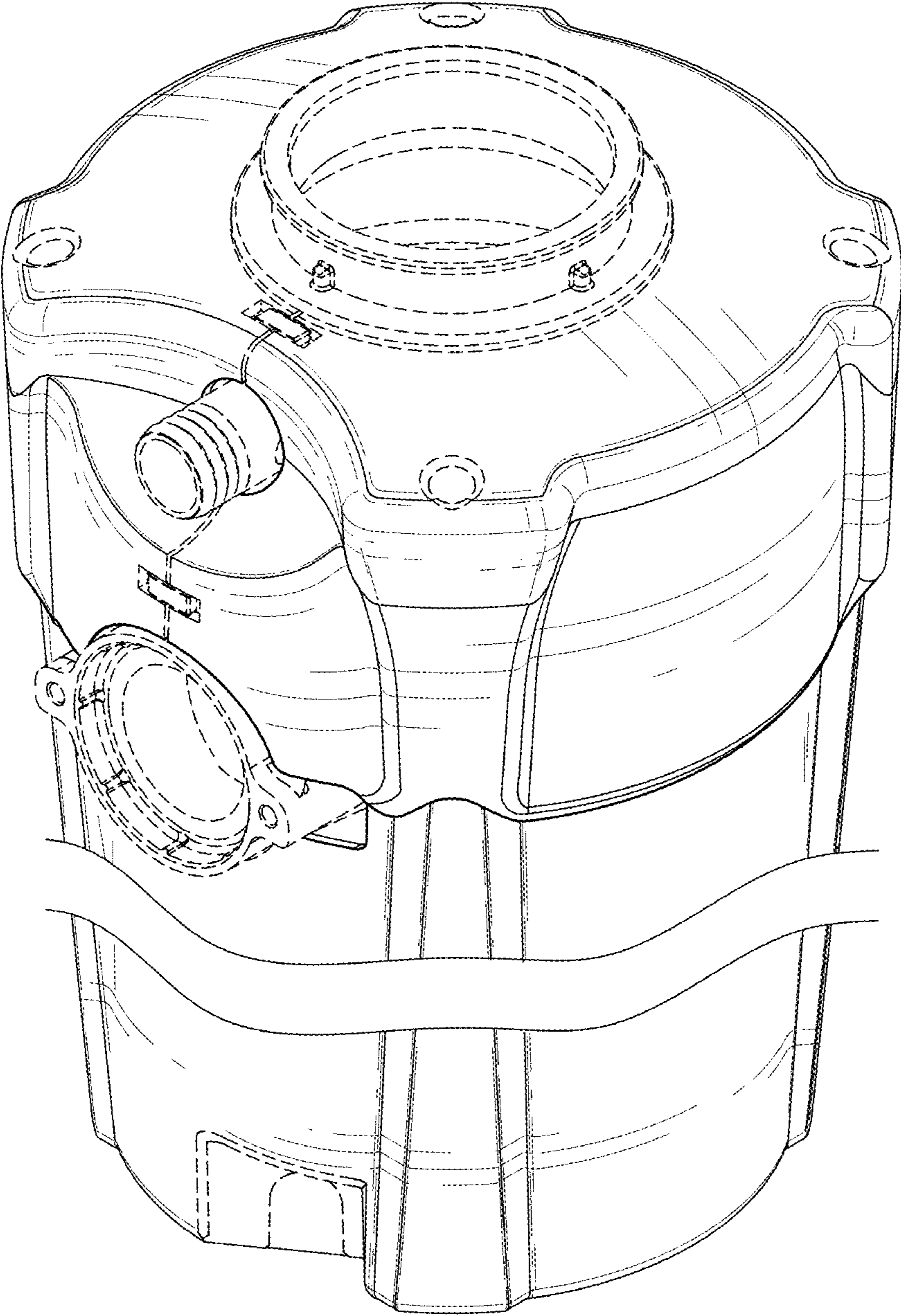

Fig-15

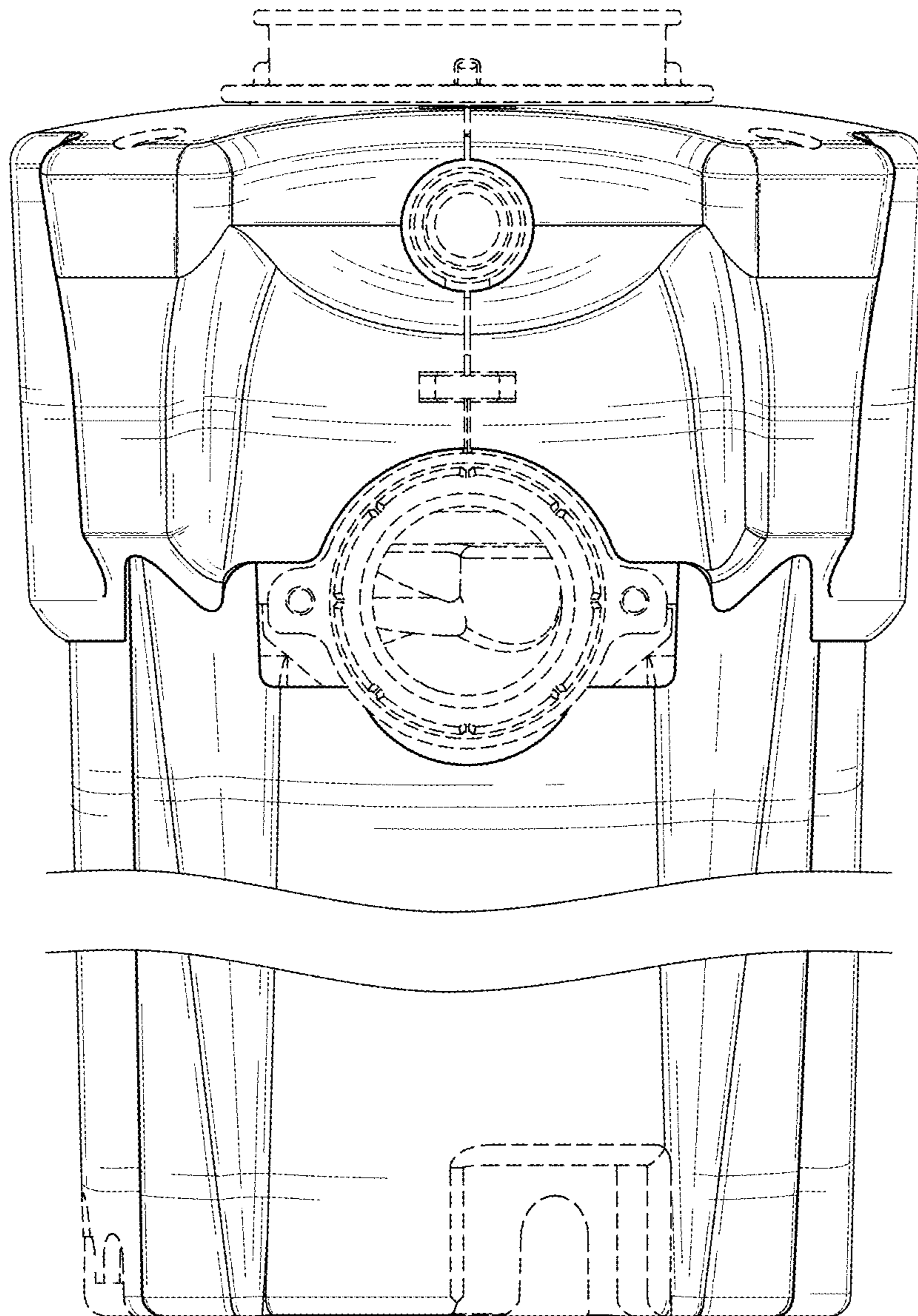

Fig-16

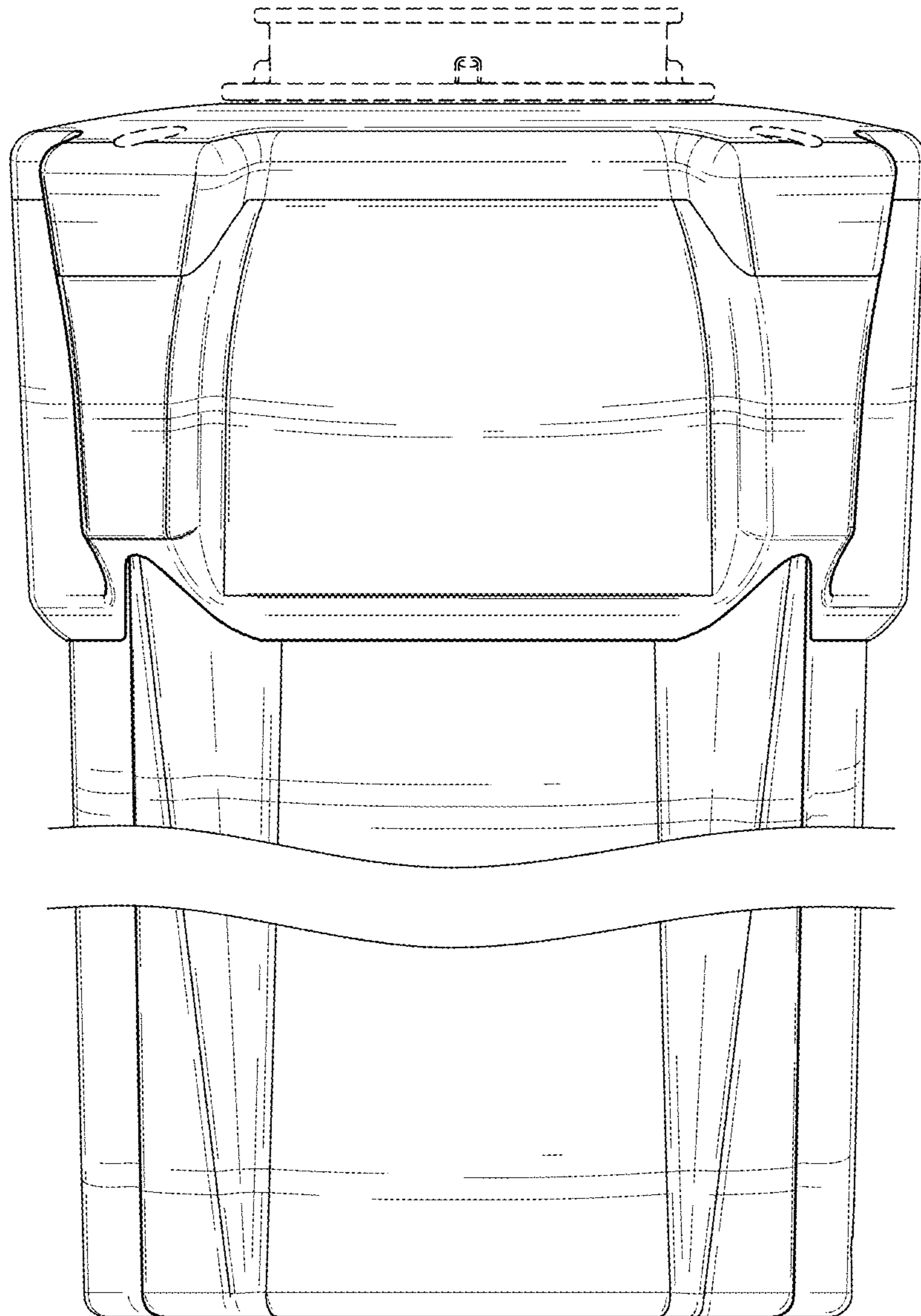

Fig-17



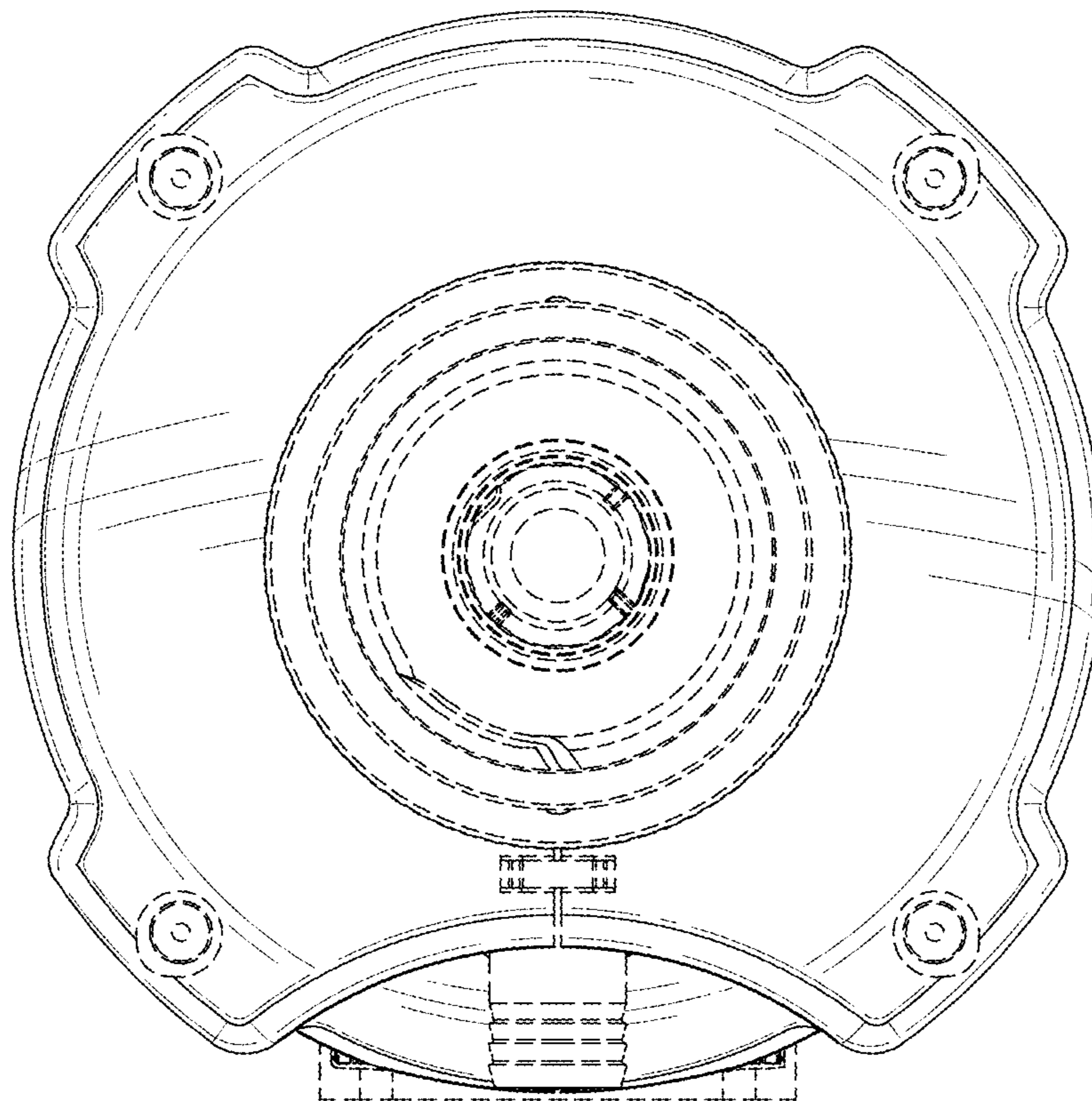

Fig-18

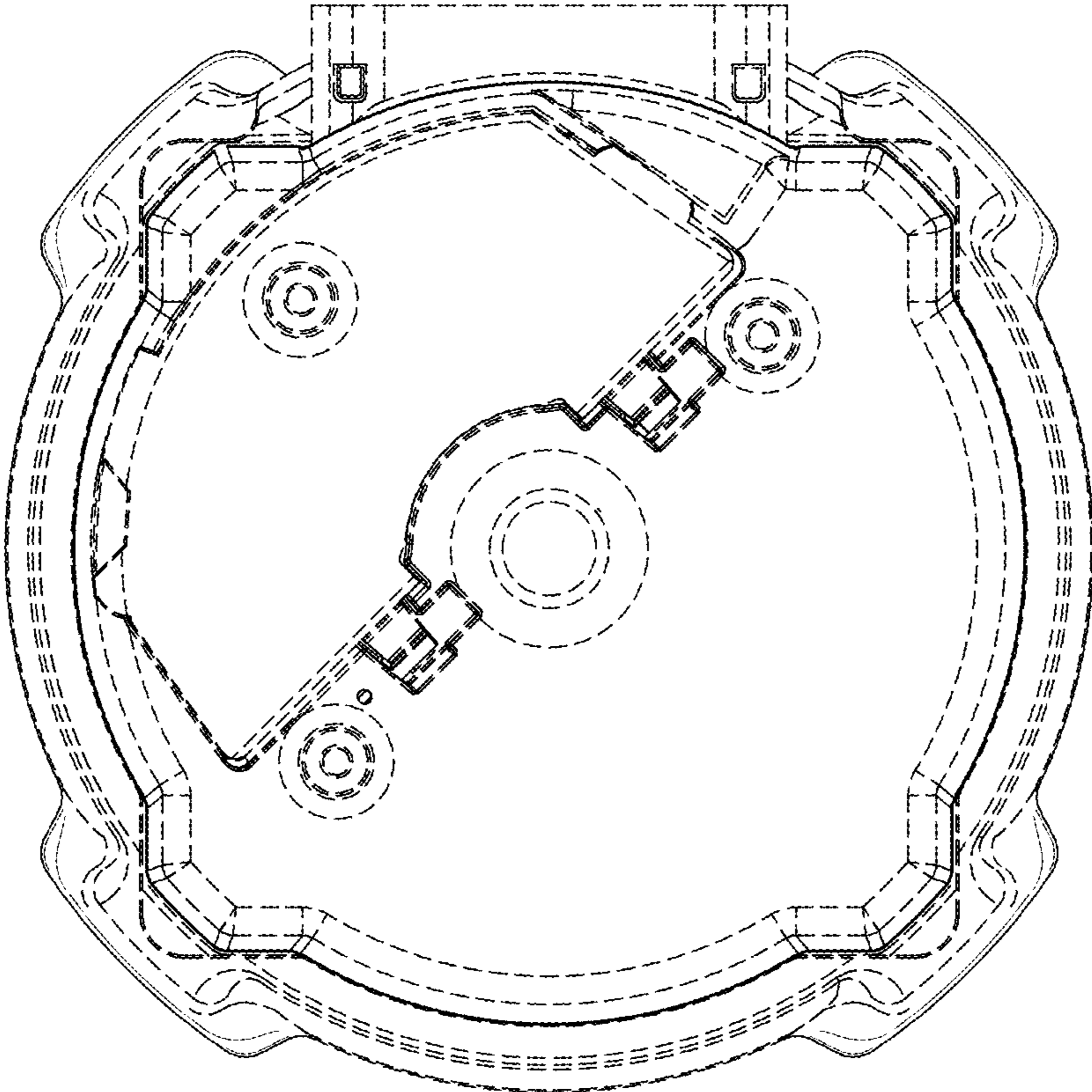

Fig-19

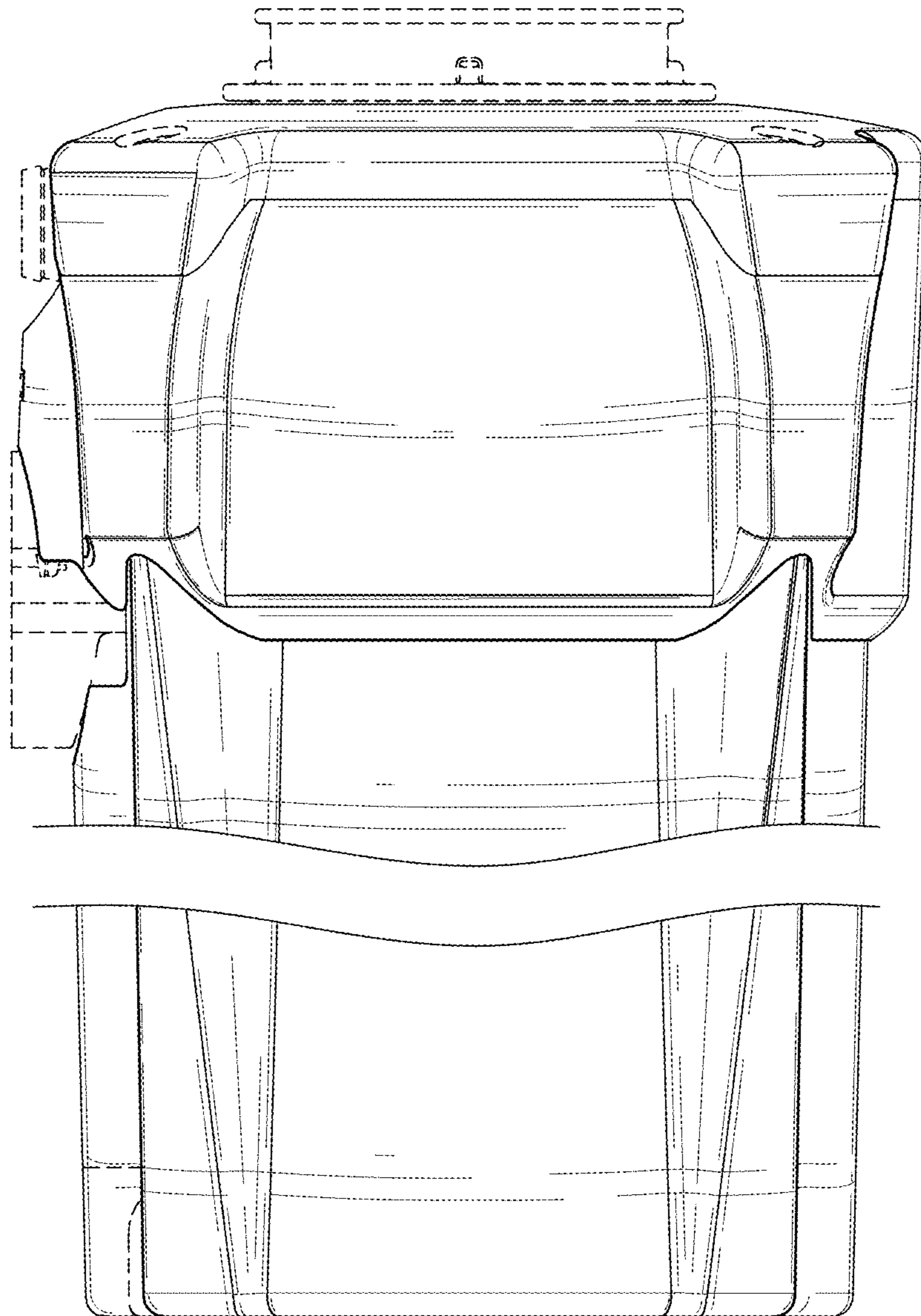

Fig-20



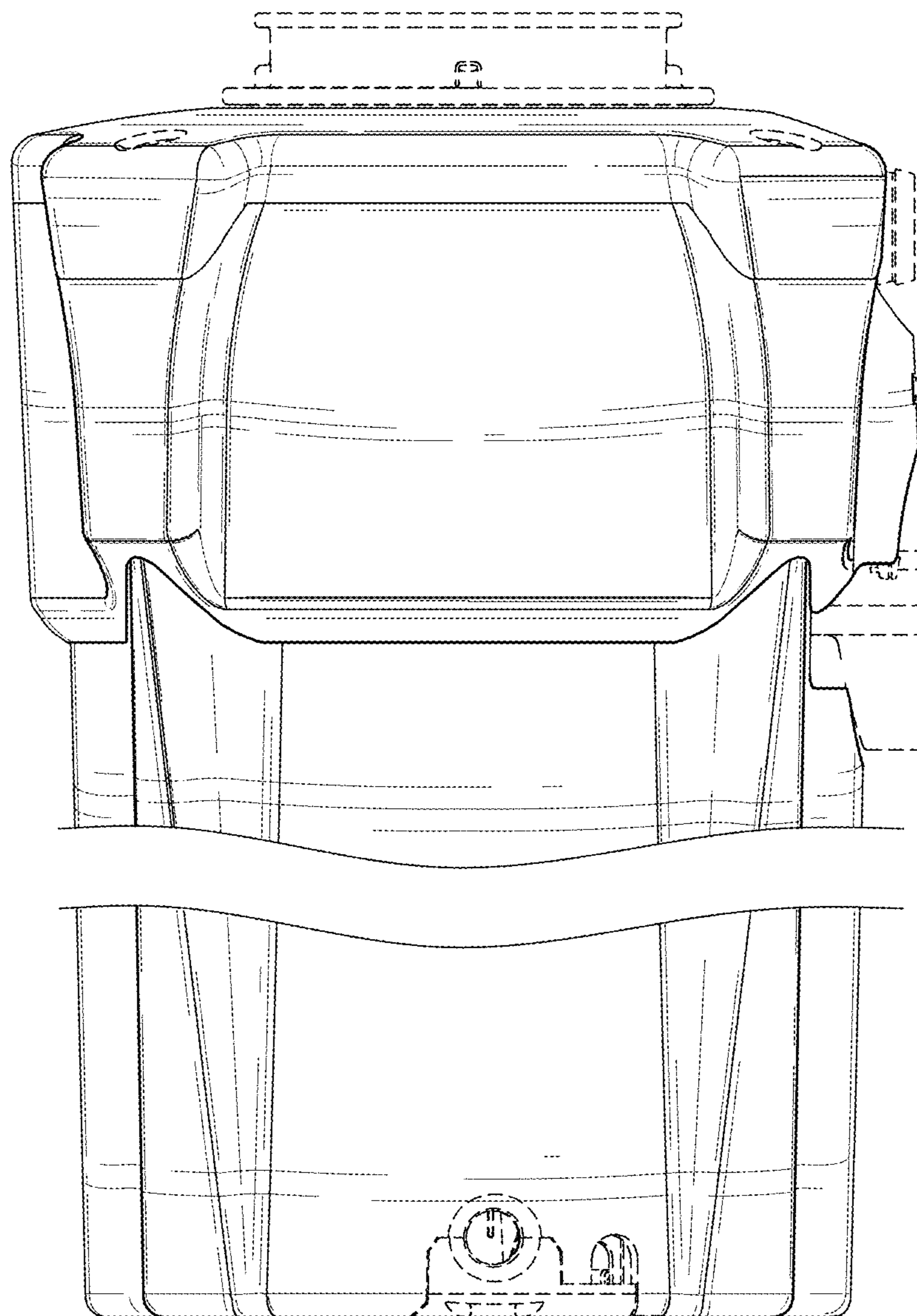

Fig-21

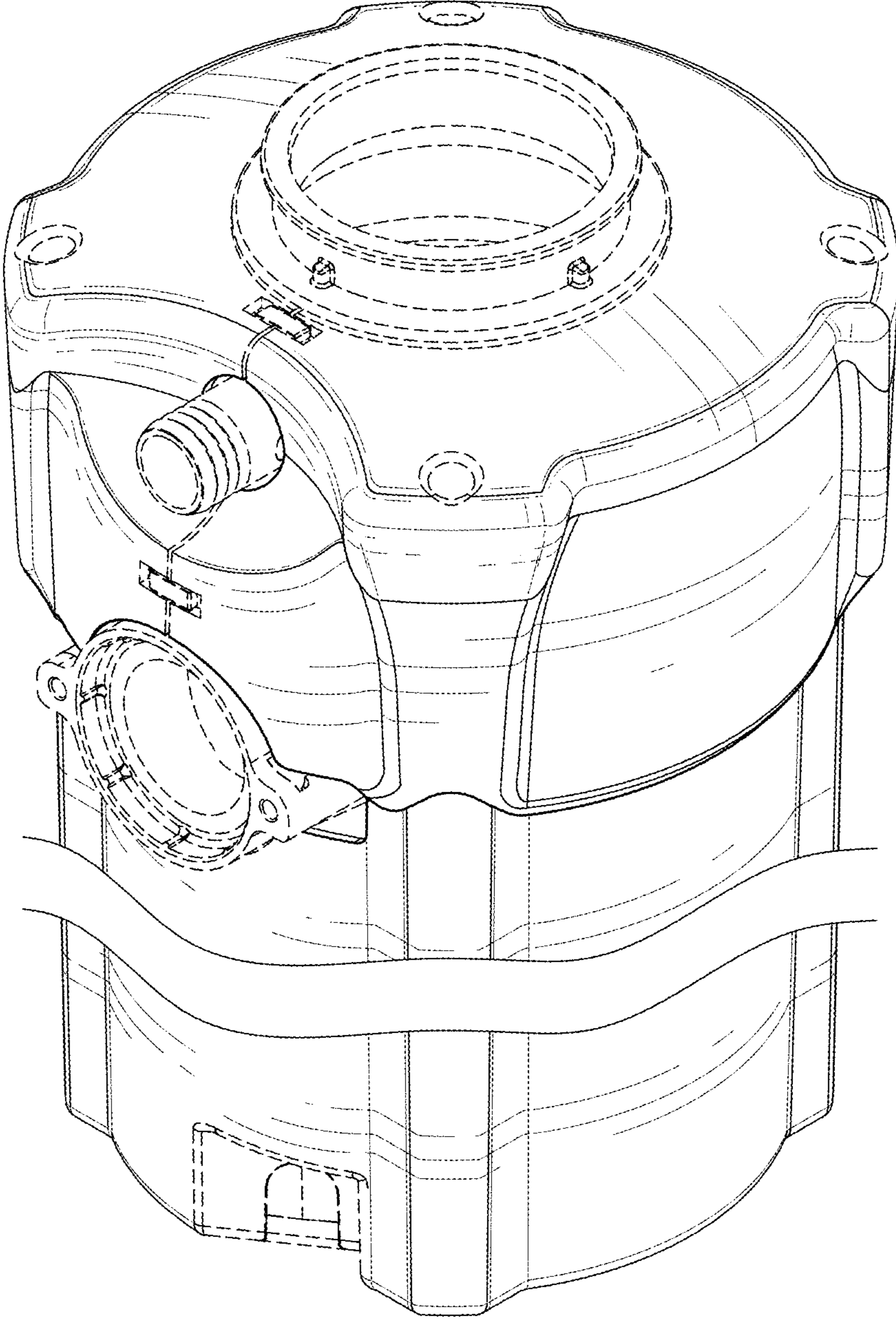

Fig-22

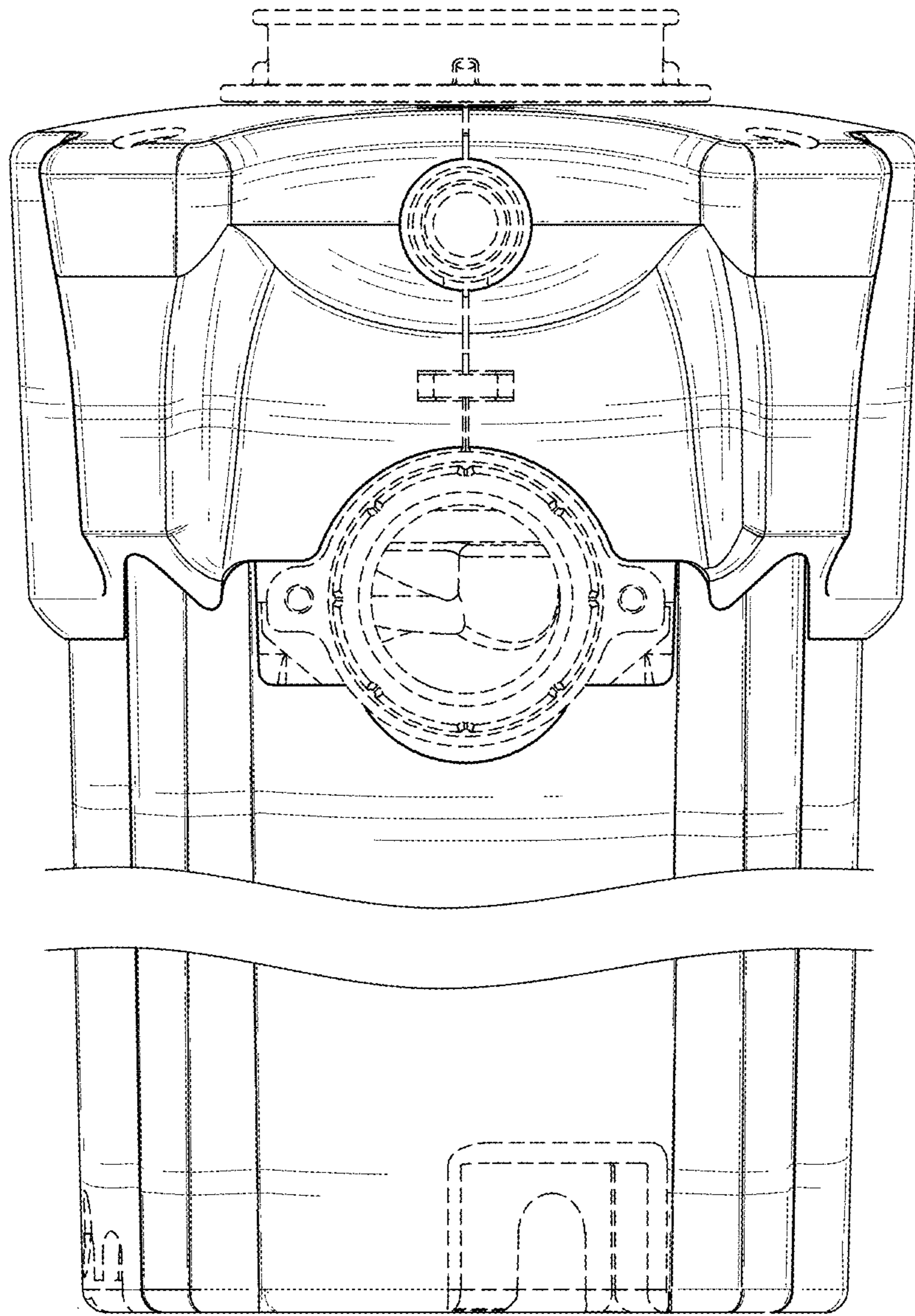

Fig-23



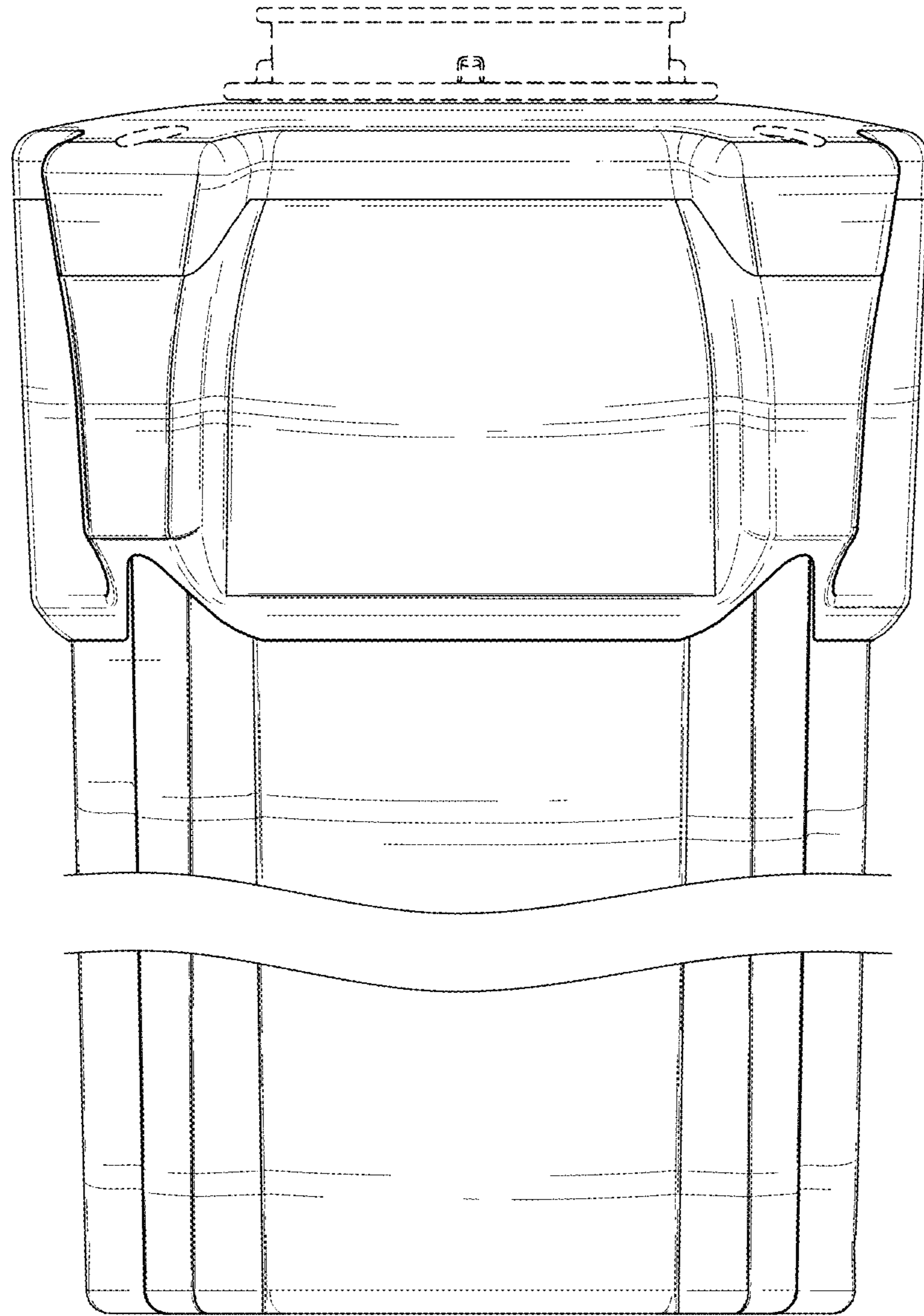

Fig-24

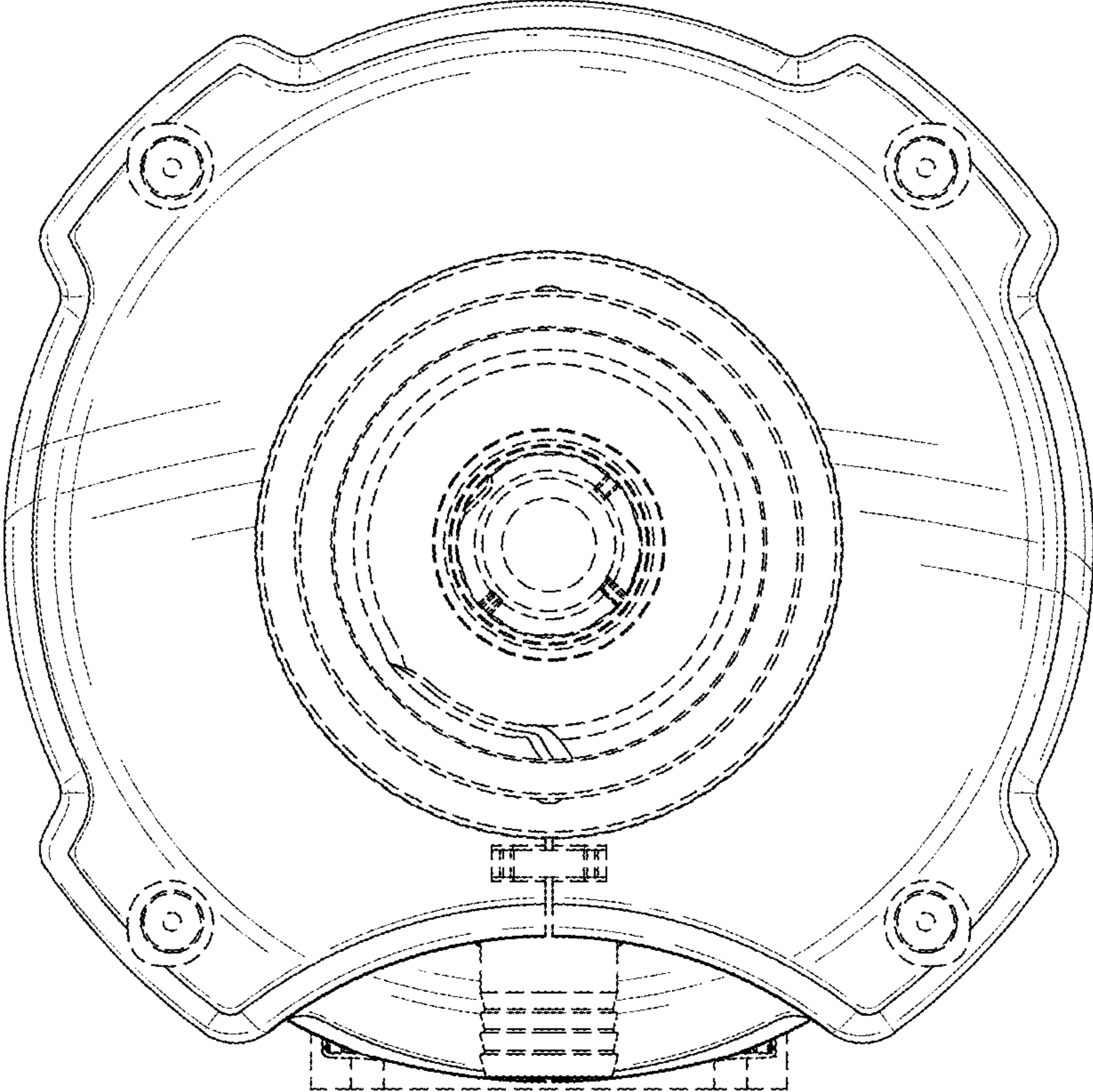

Fig-25

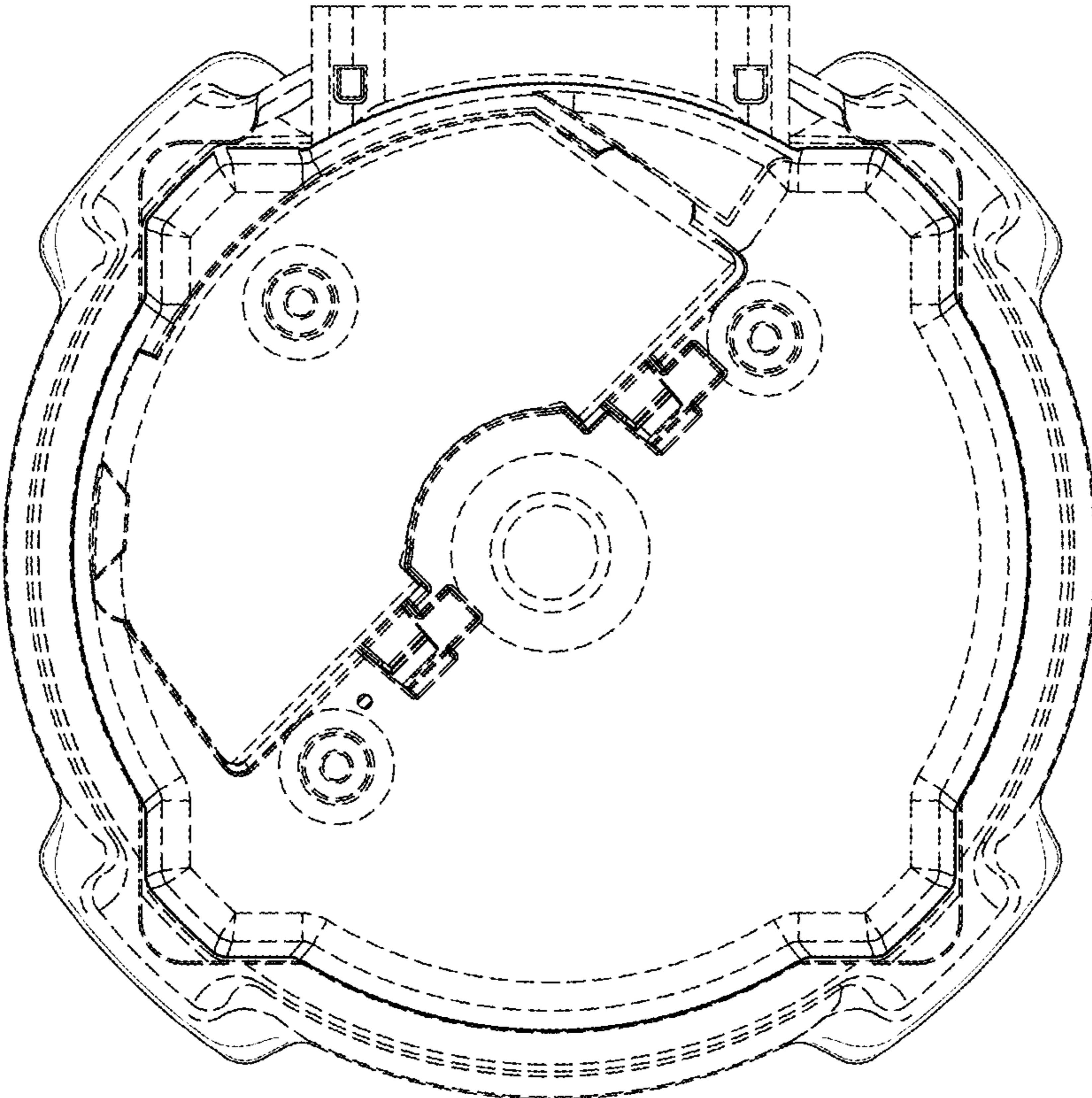

Fig-26



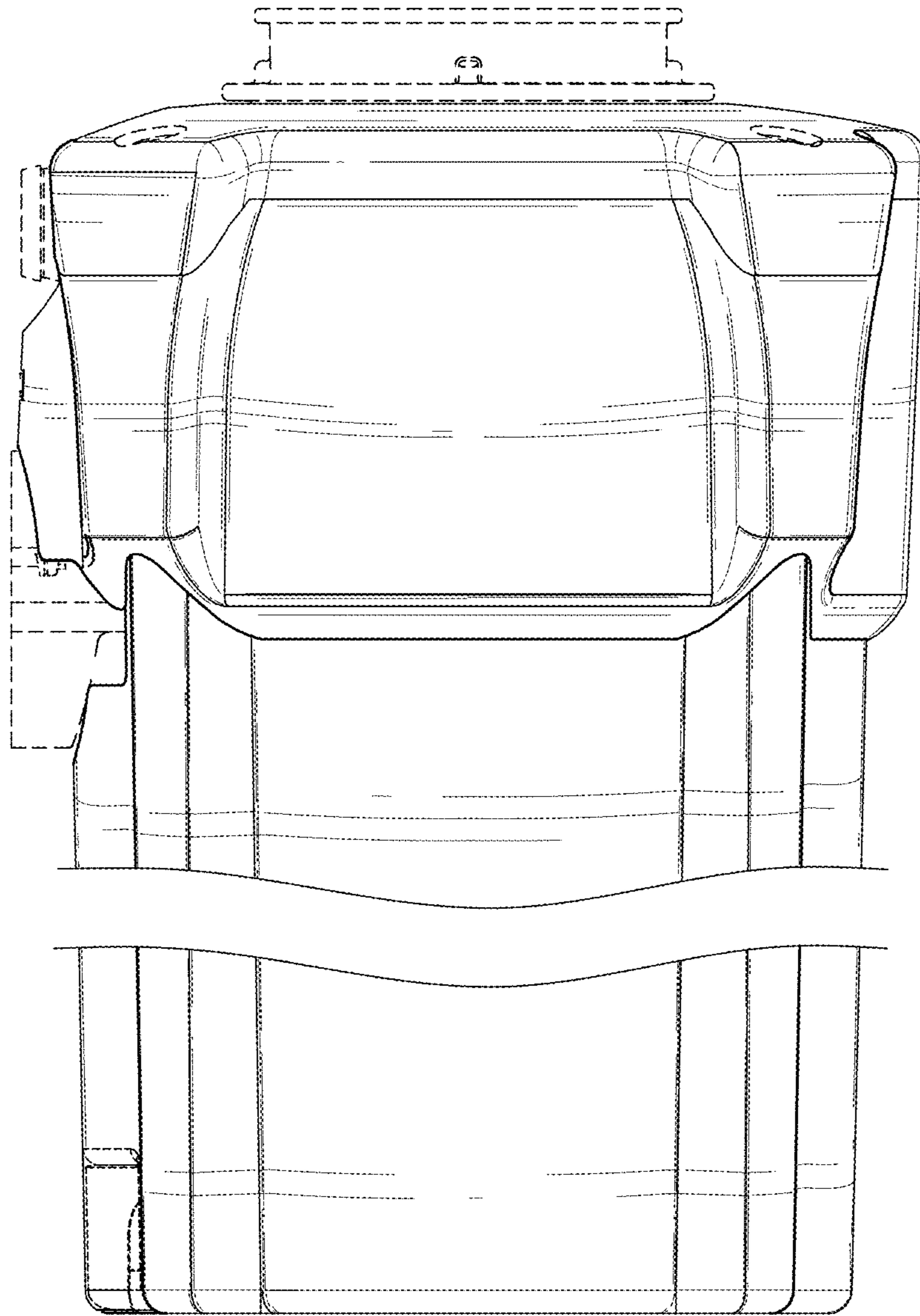

Fig-27

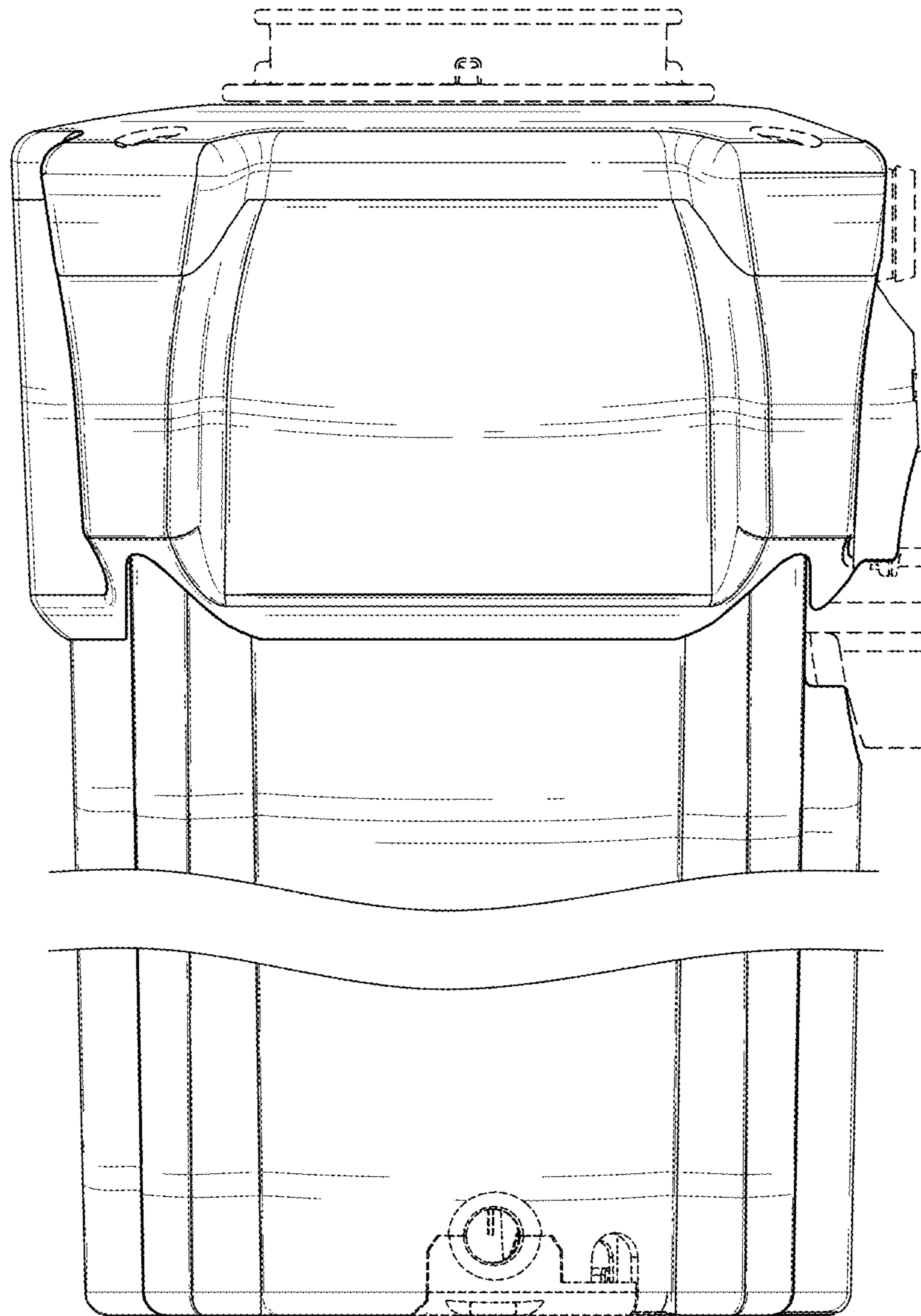

Fig-28

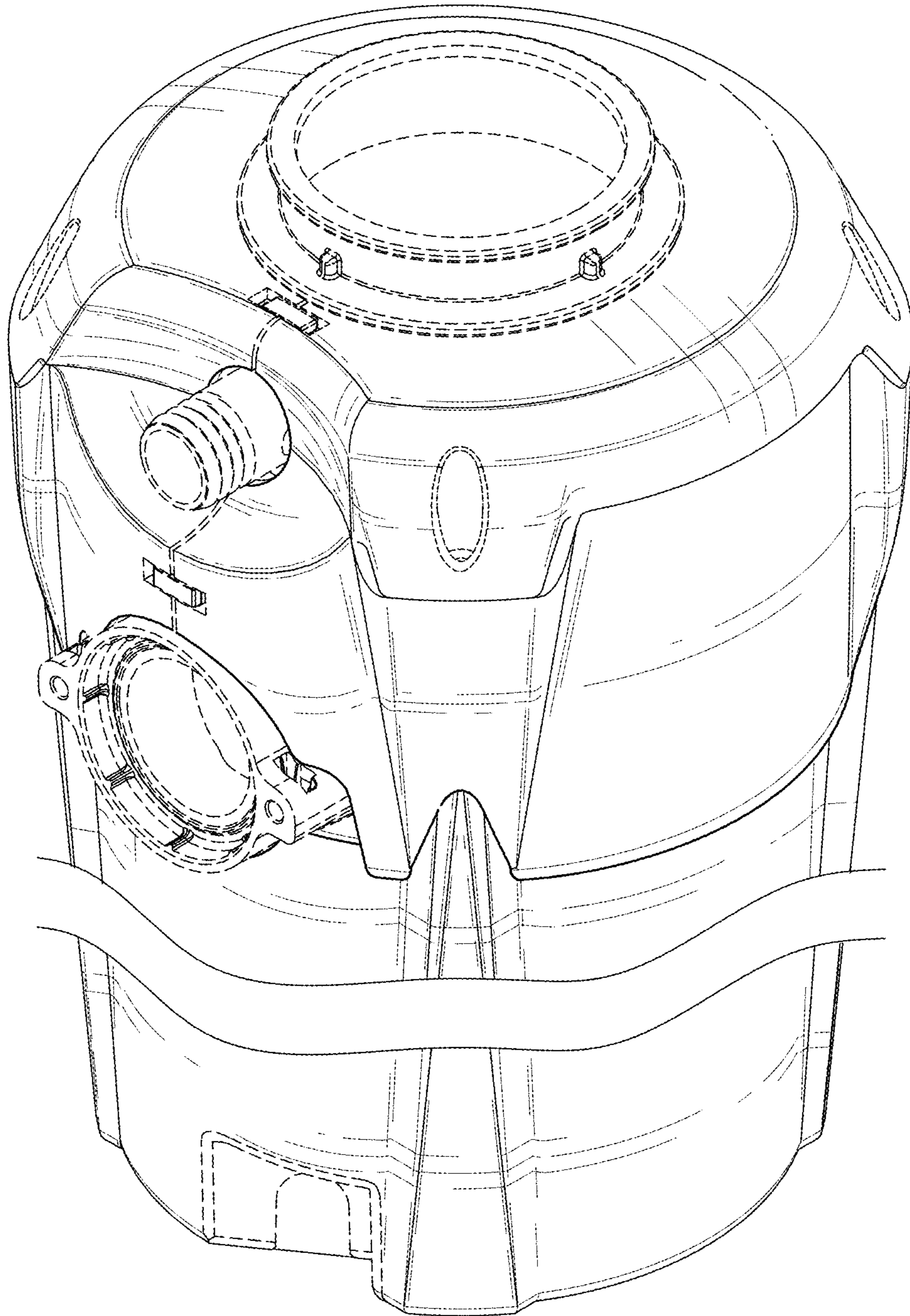

Fig-29

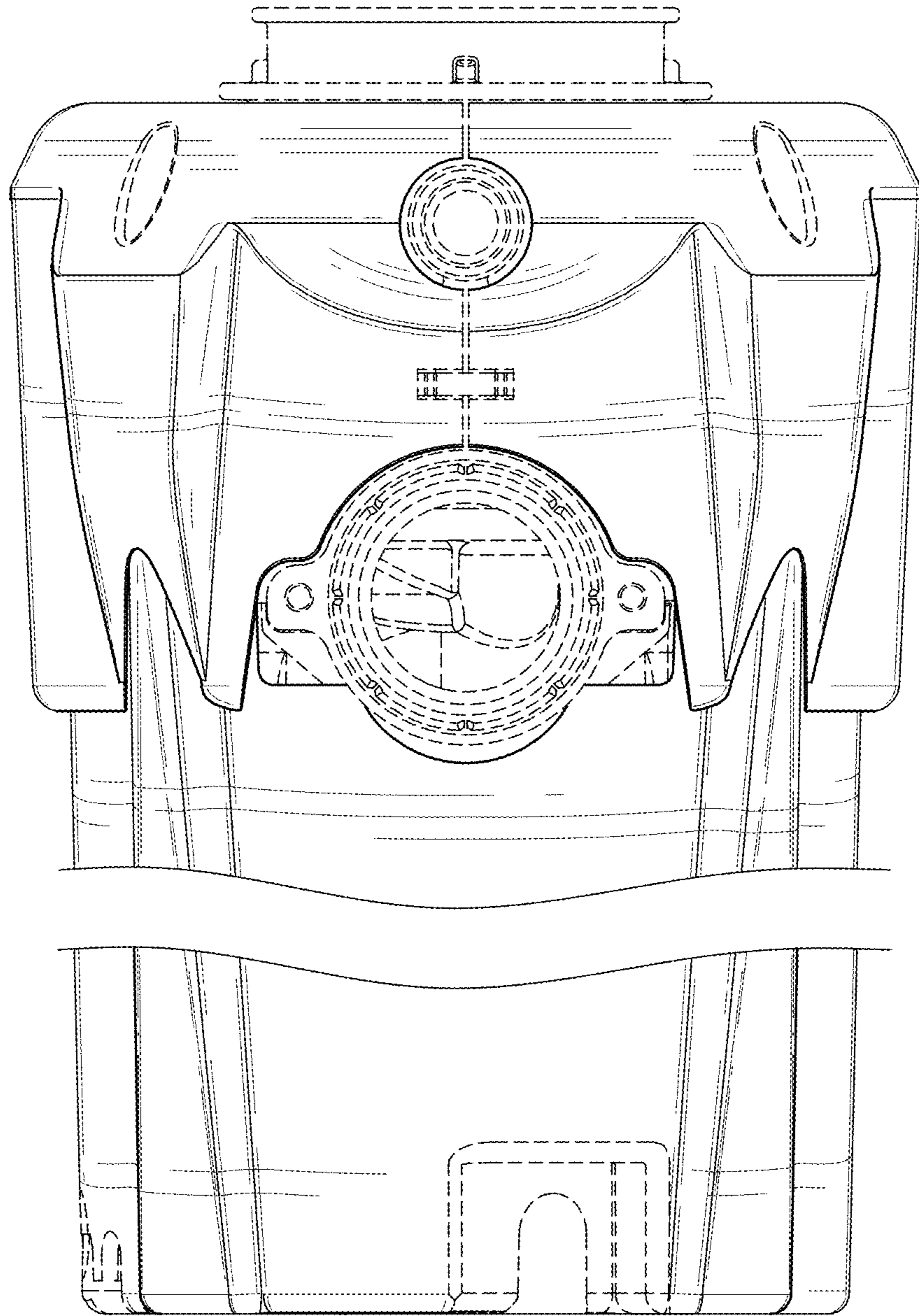

Fig-30



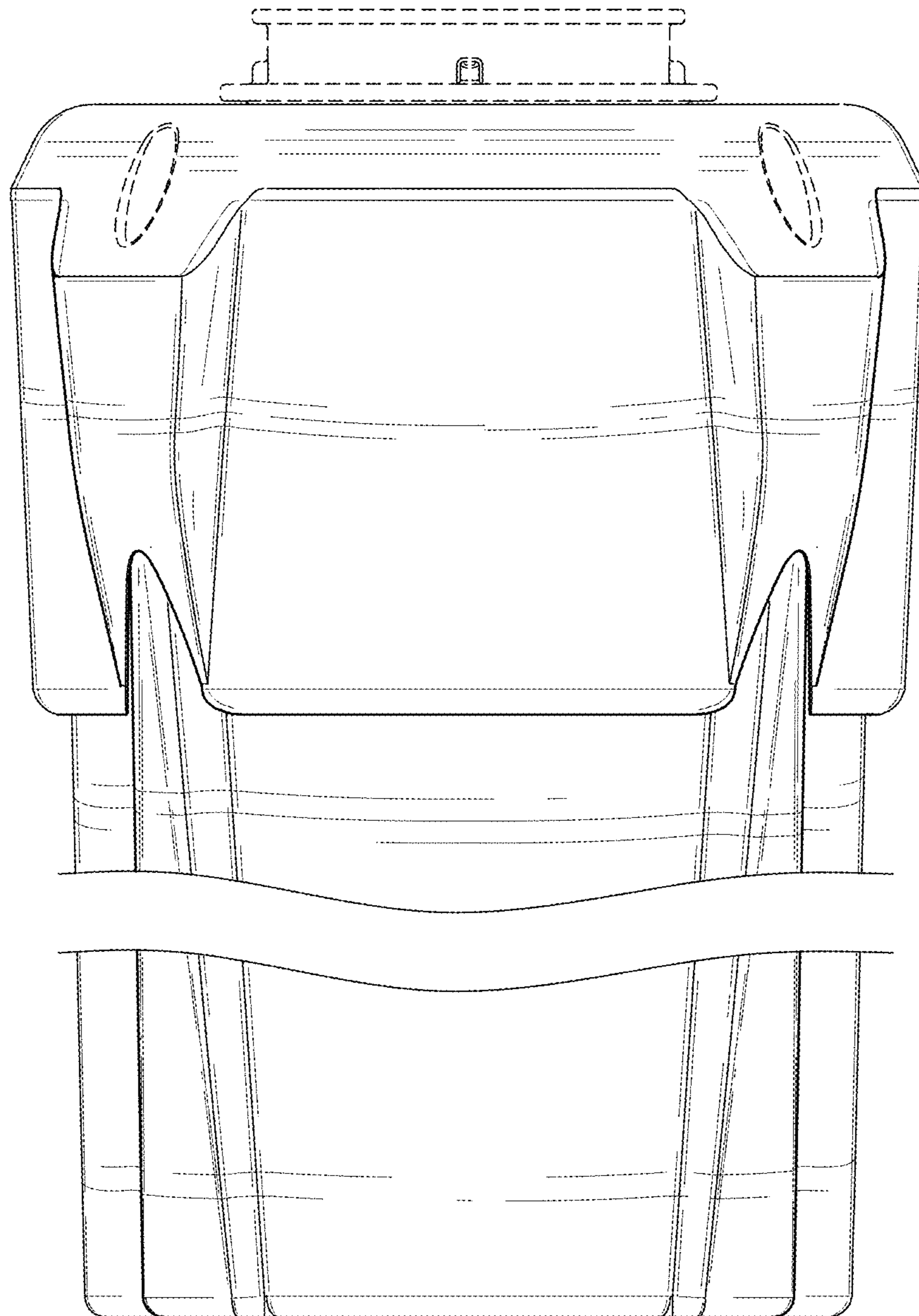

Fig-31

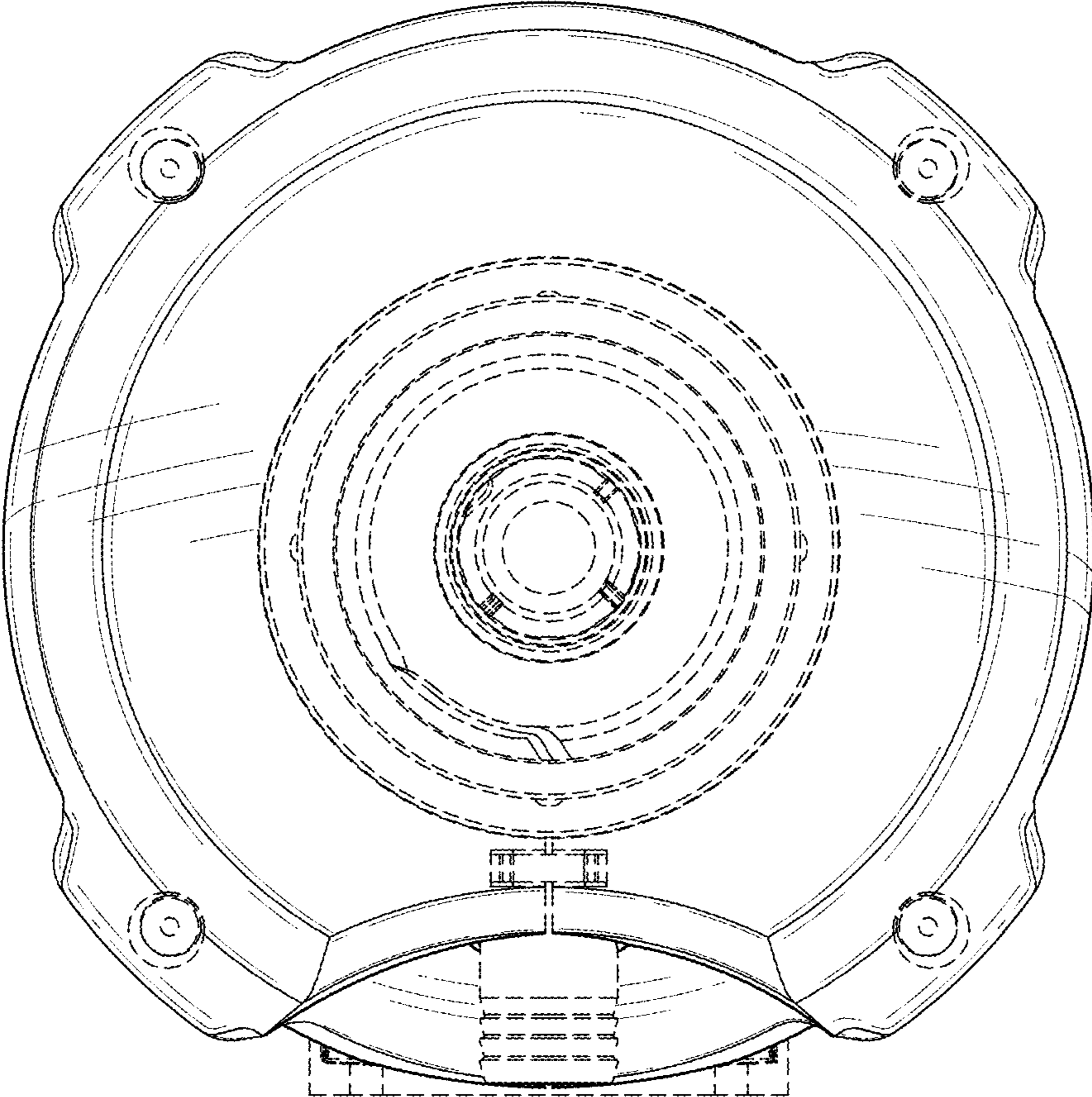

Fig-32

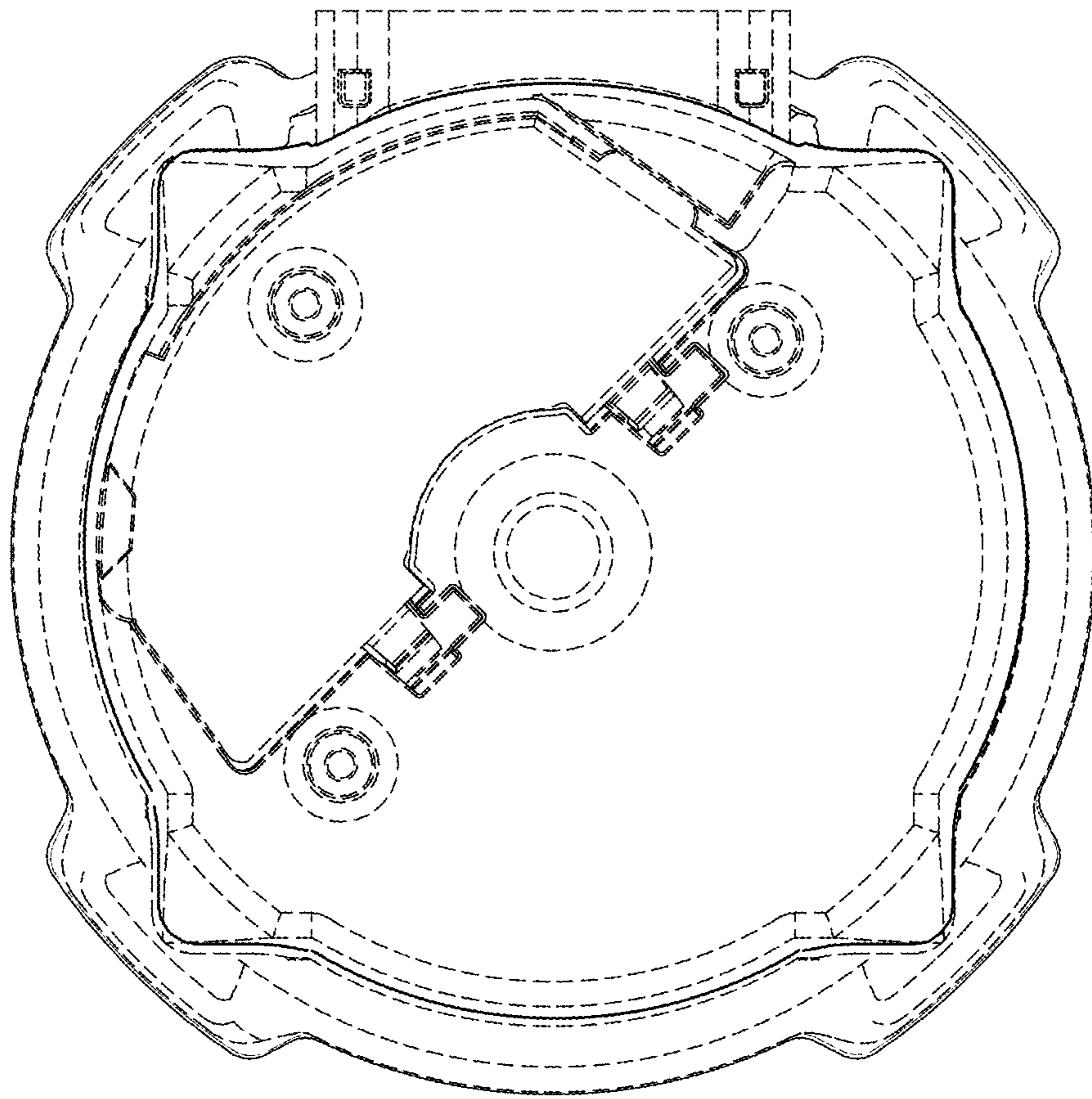

Fig-33

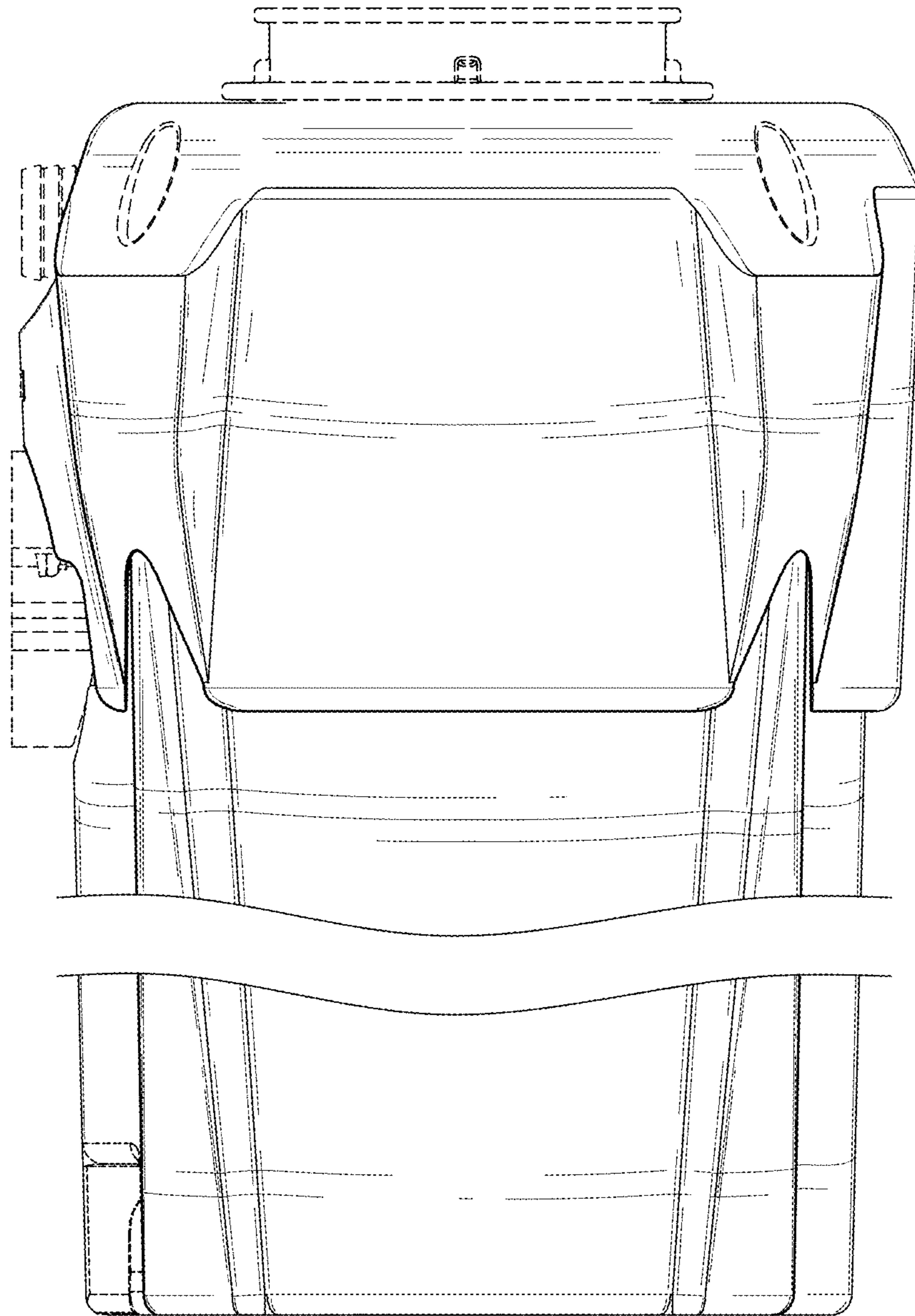

Fig-34



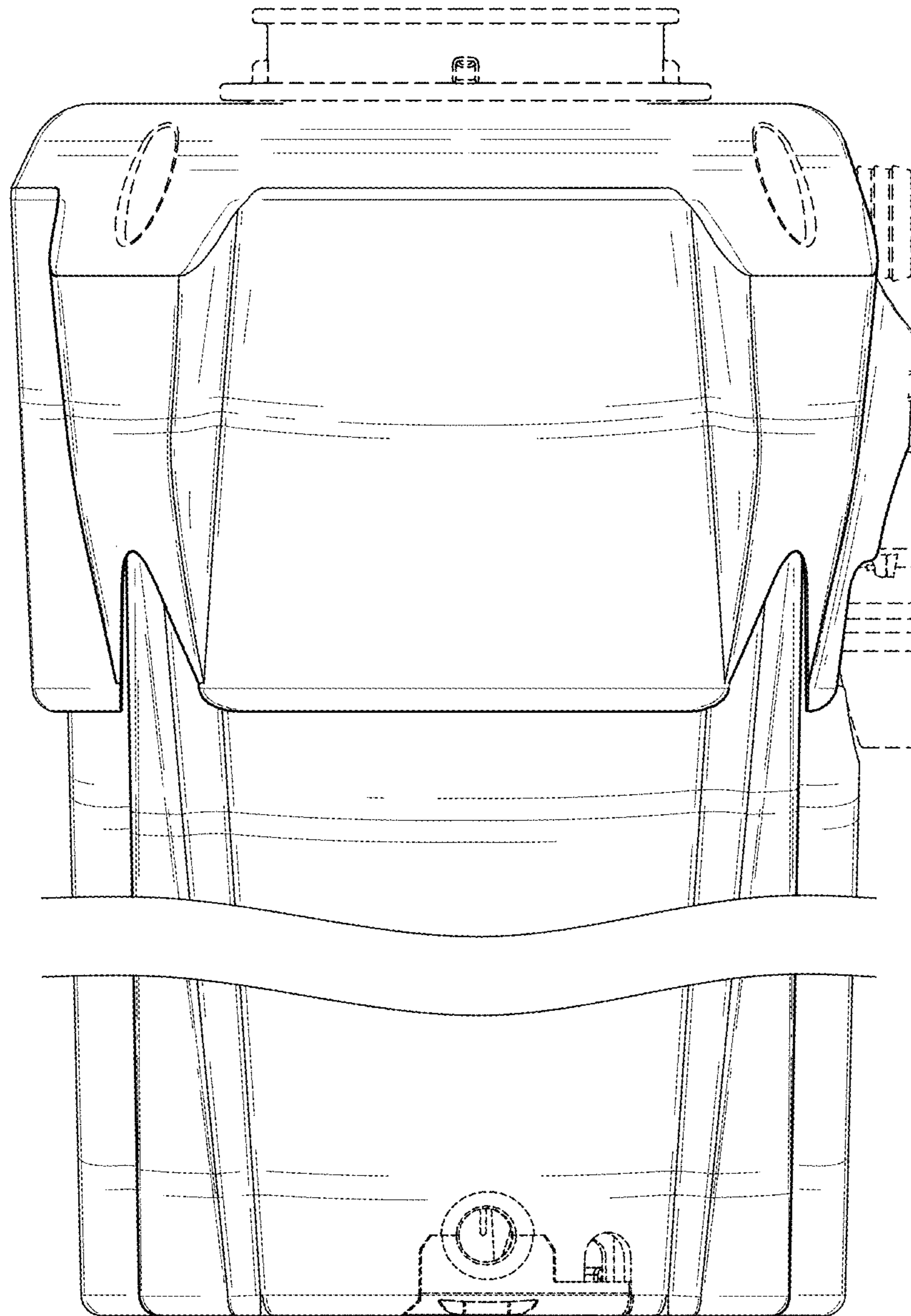

Fig-35

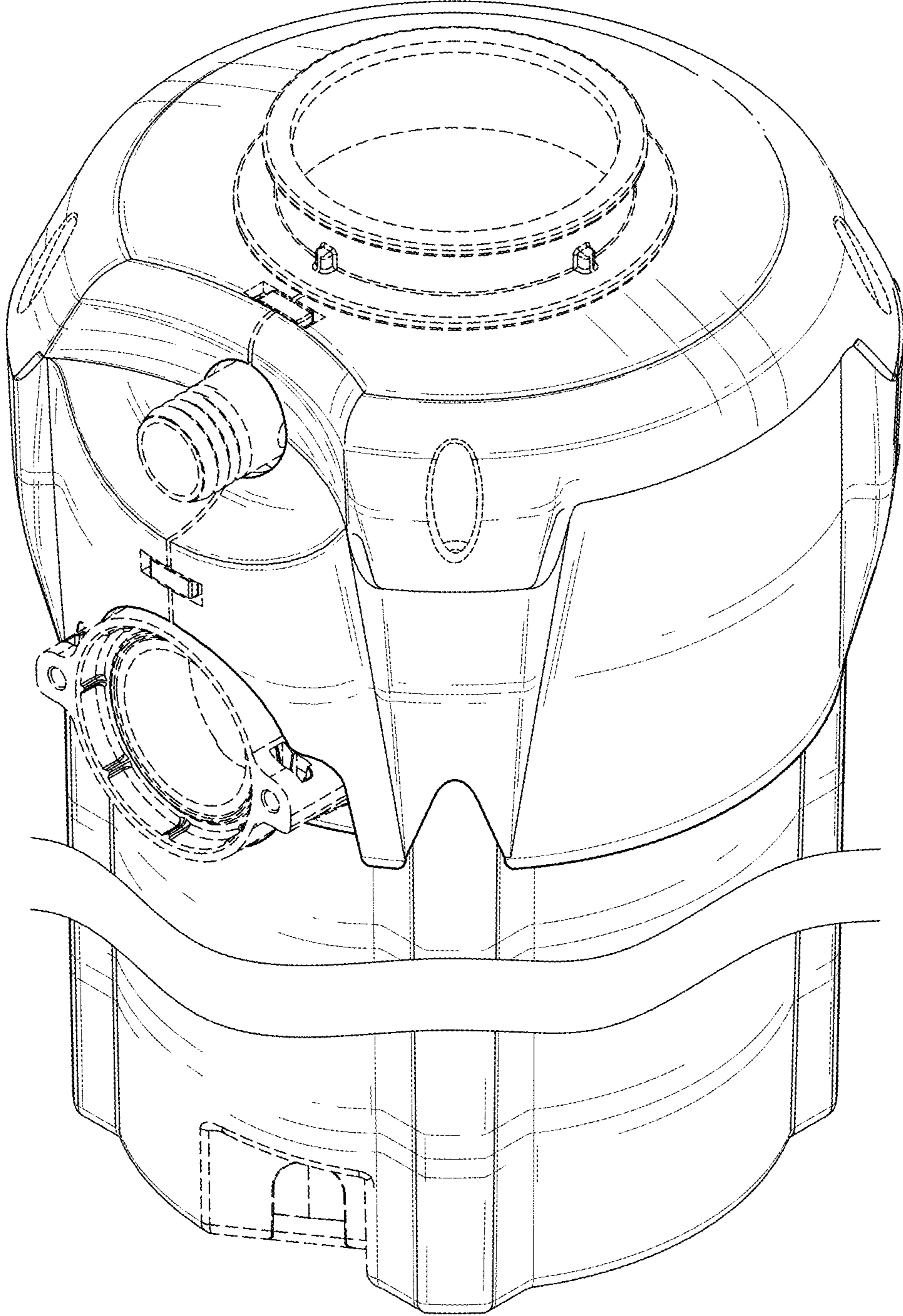

Fig-36

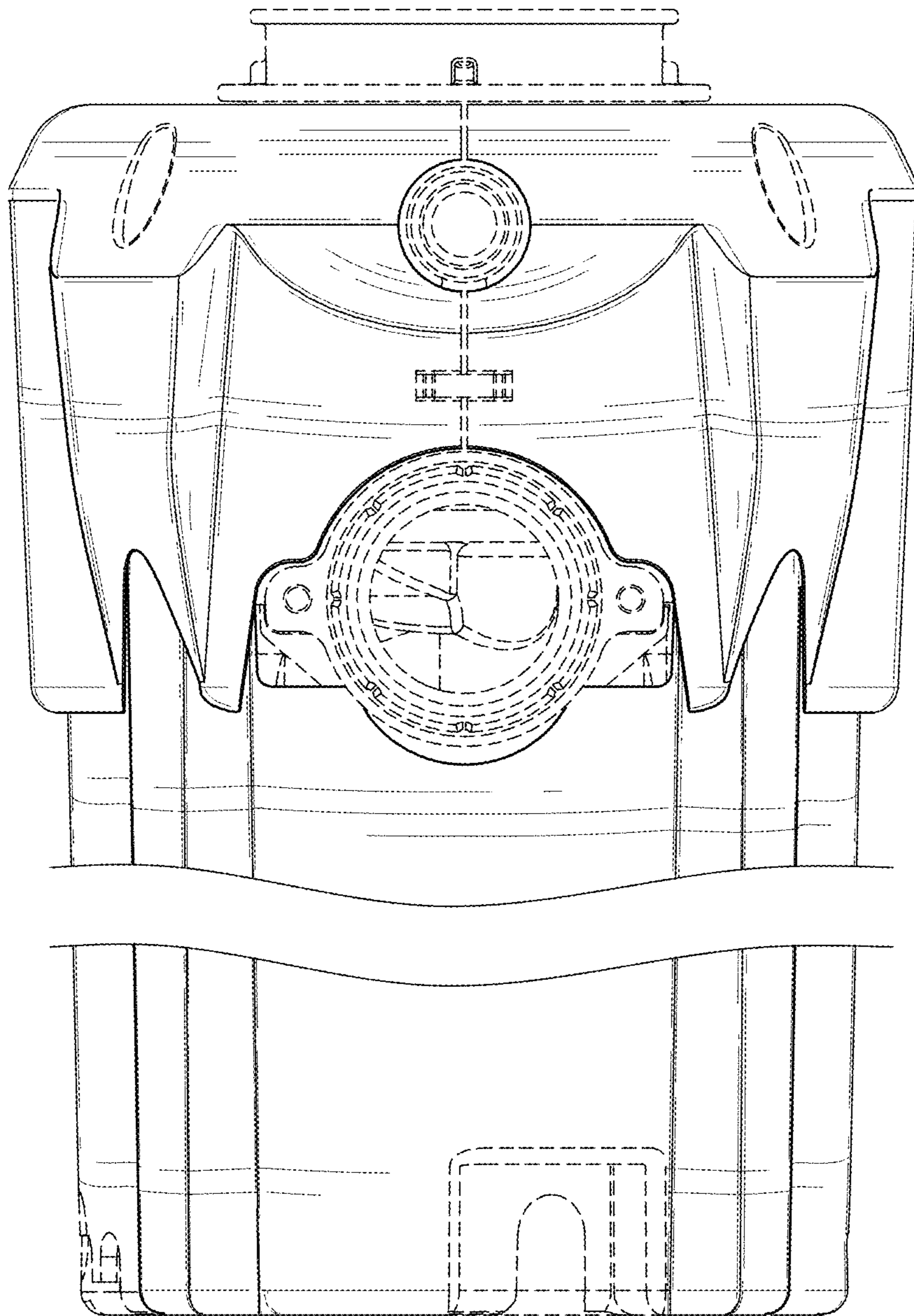

Fig-37

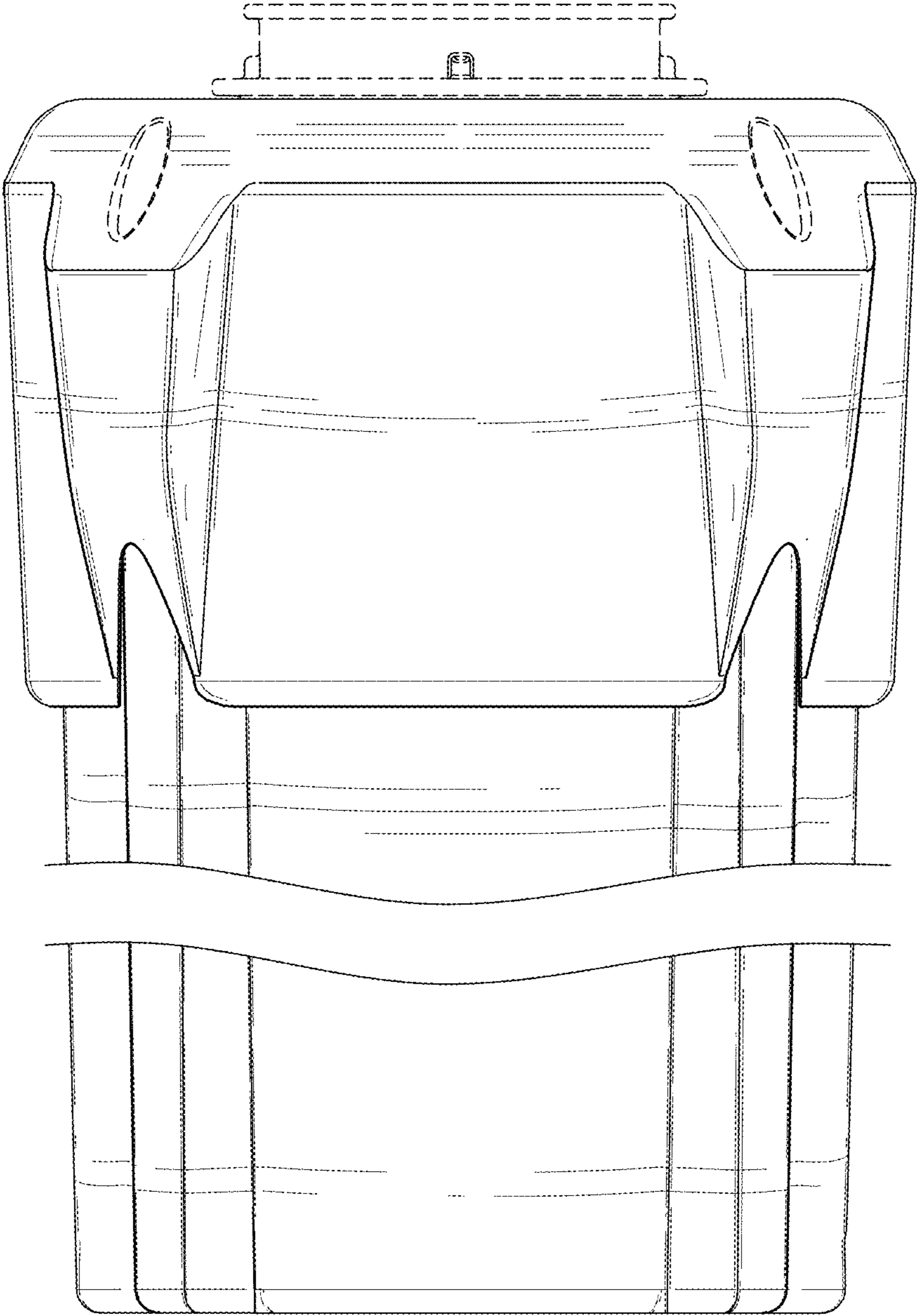

Fig-38



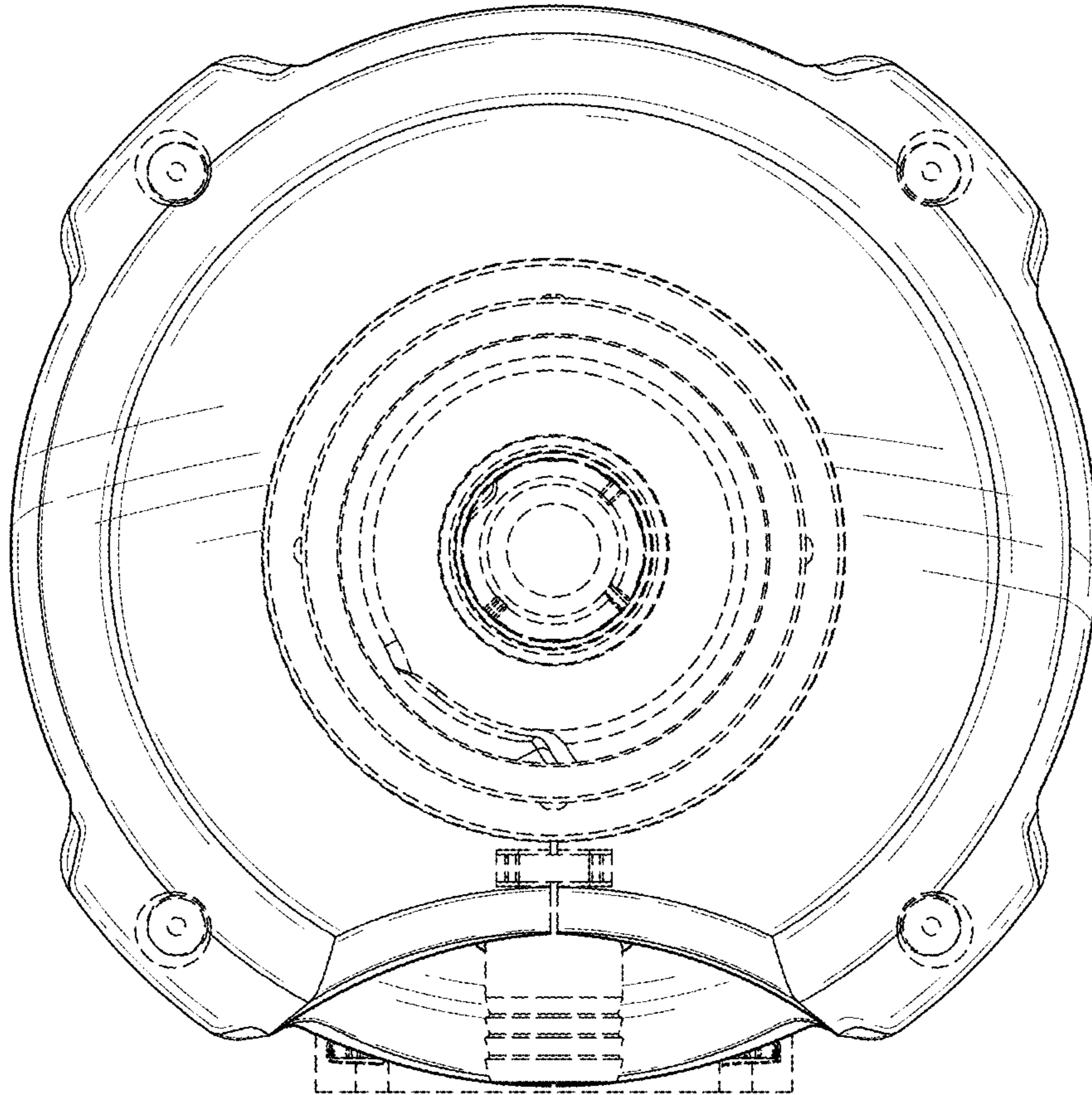

Fig-39

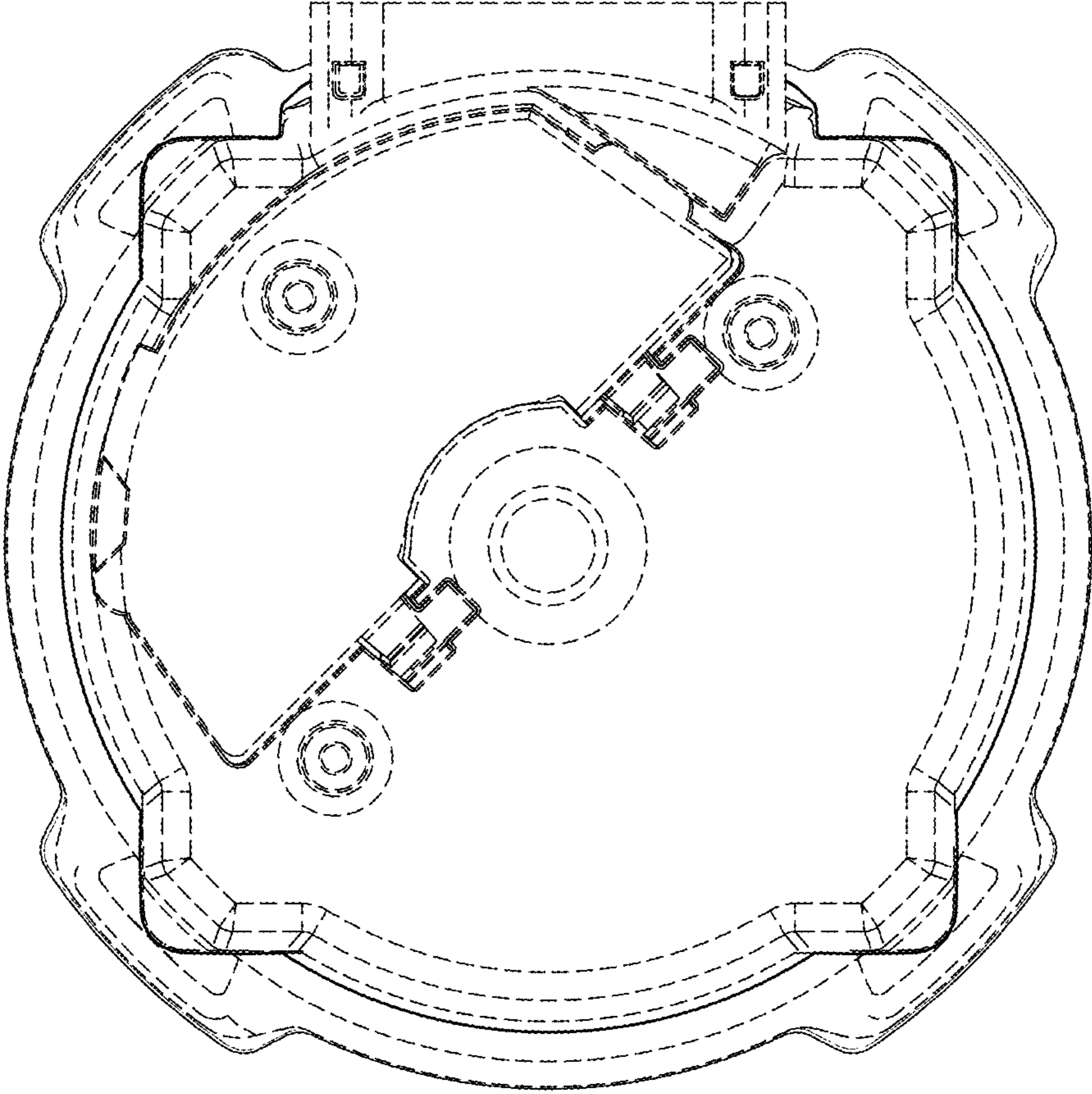

Fig-40

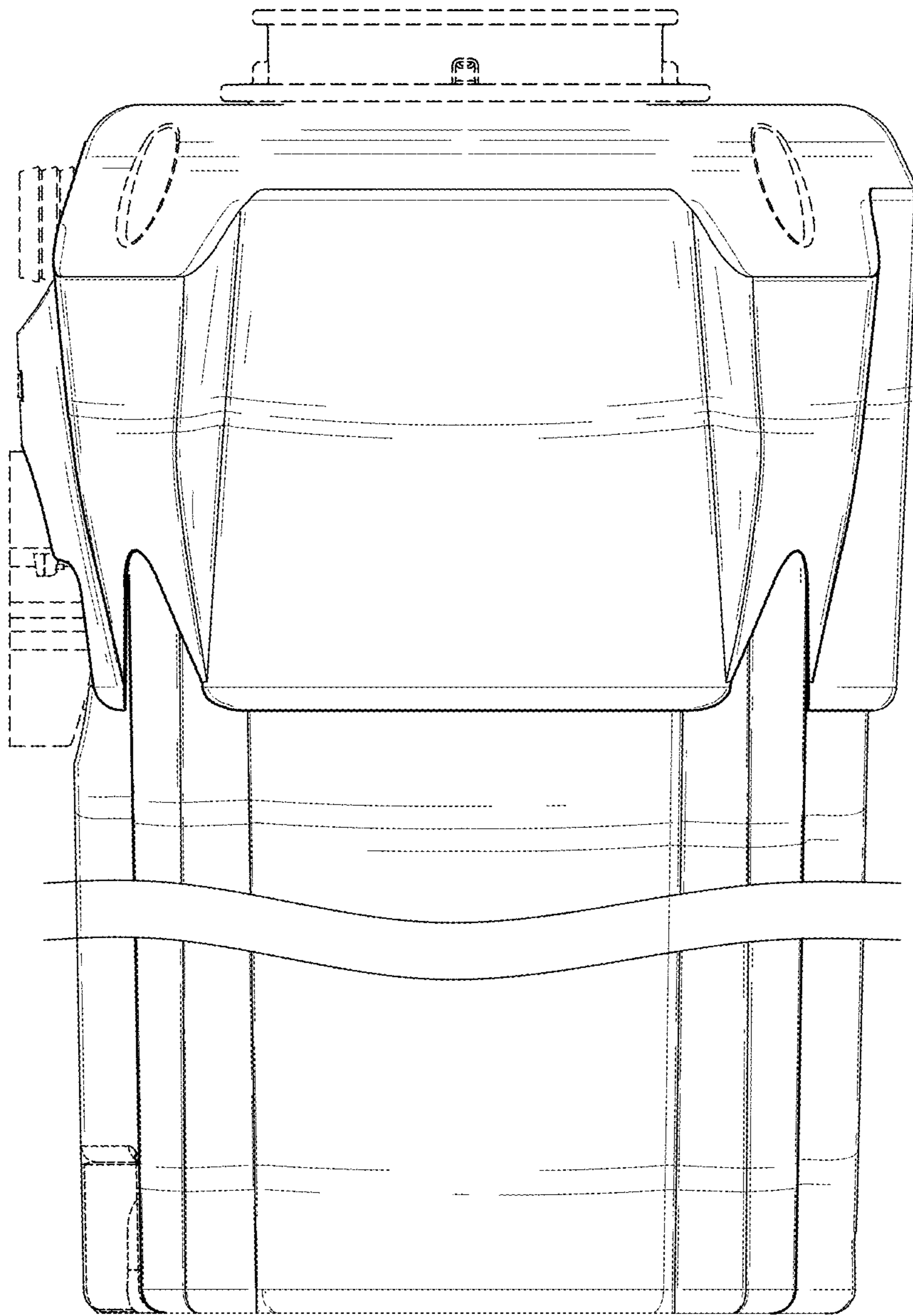

Fig-41

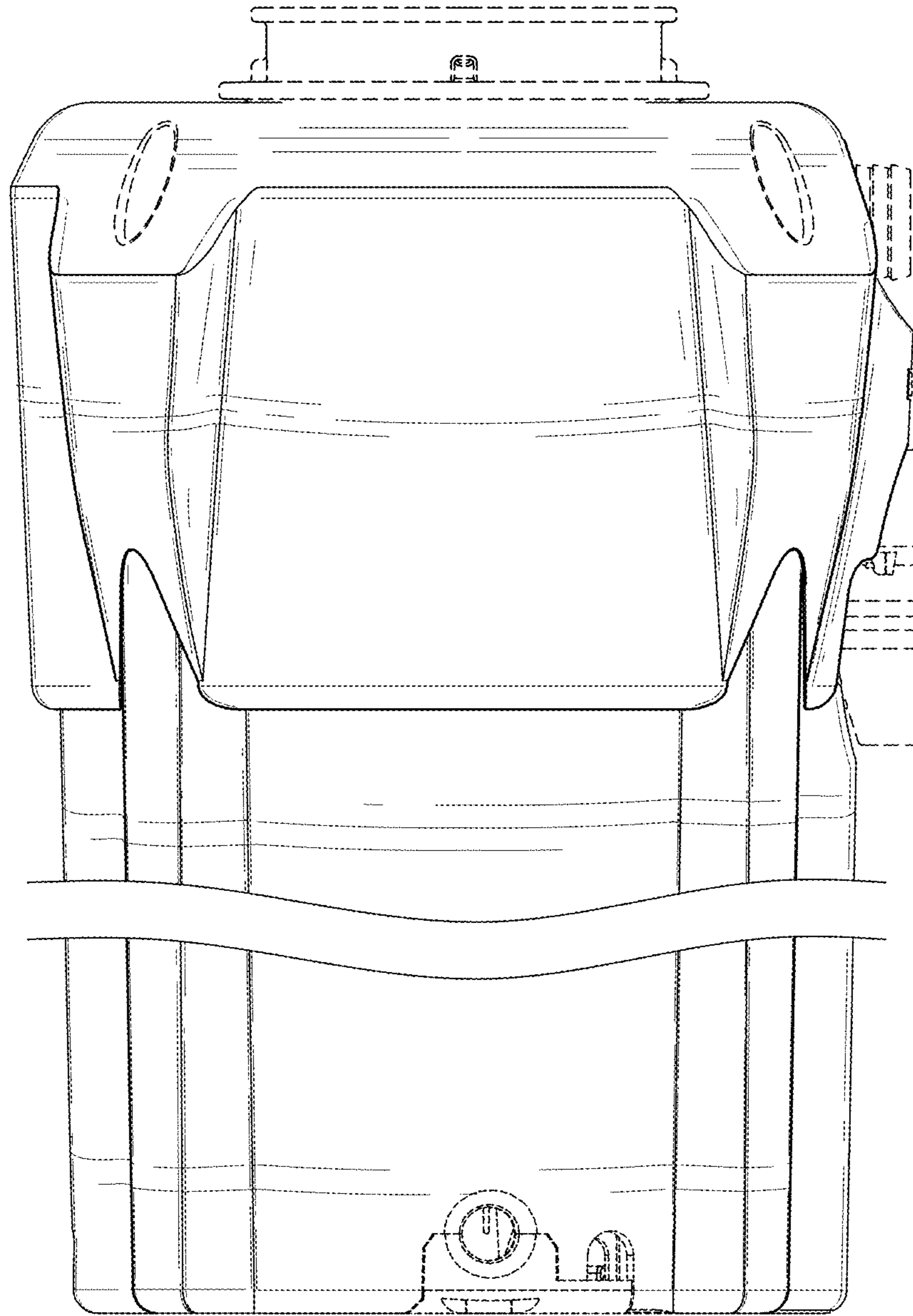

Fig-42



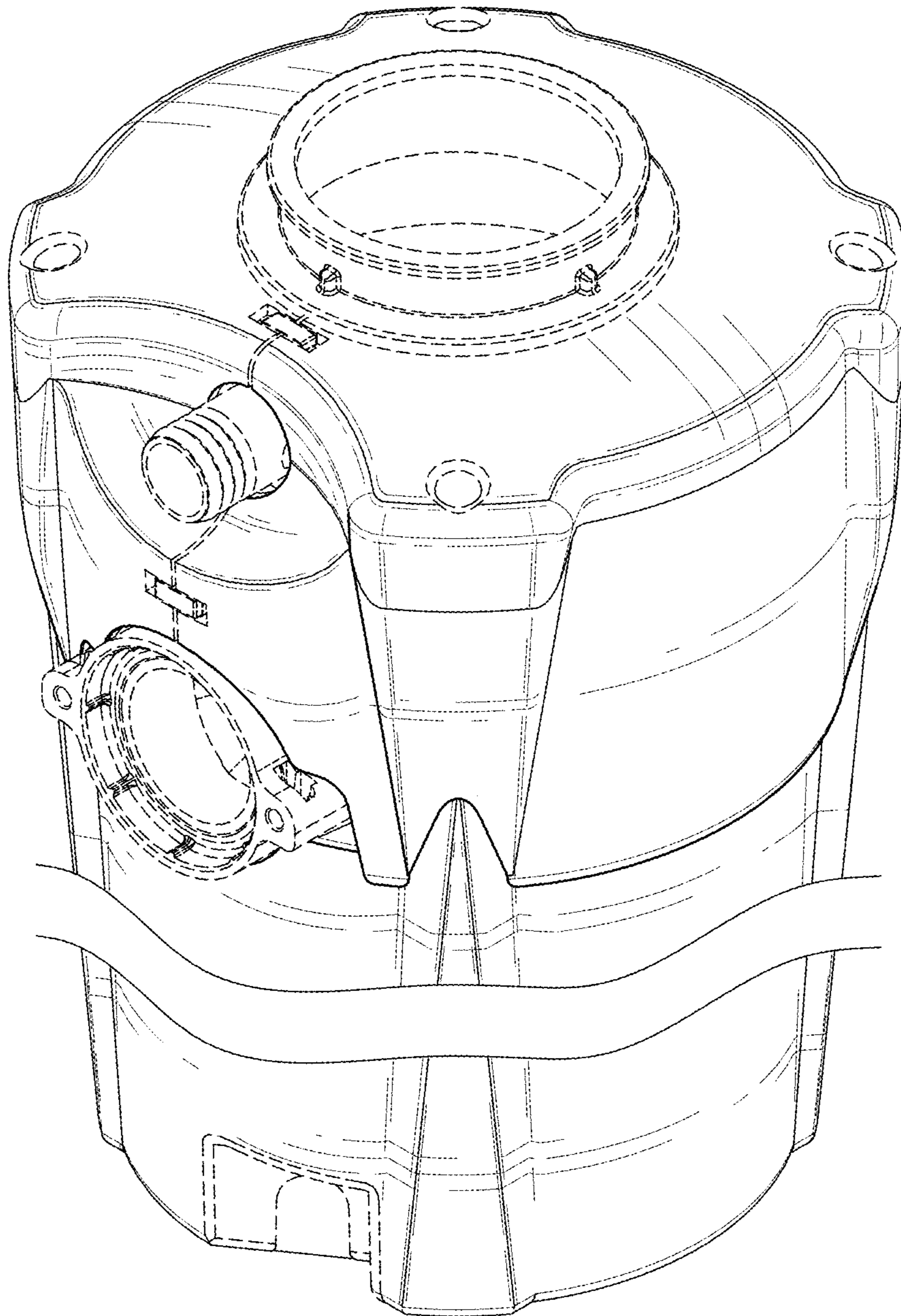

Fig-43

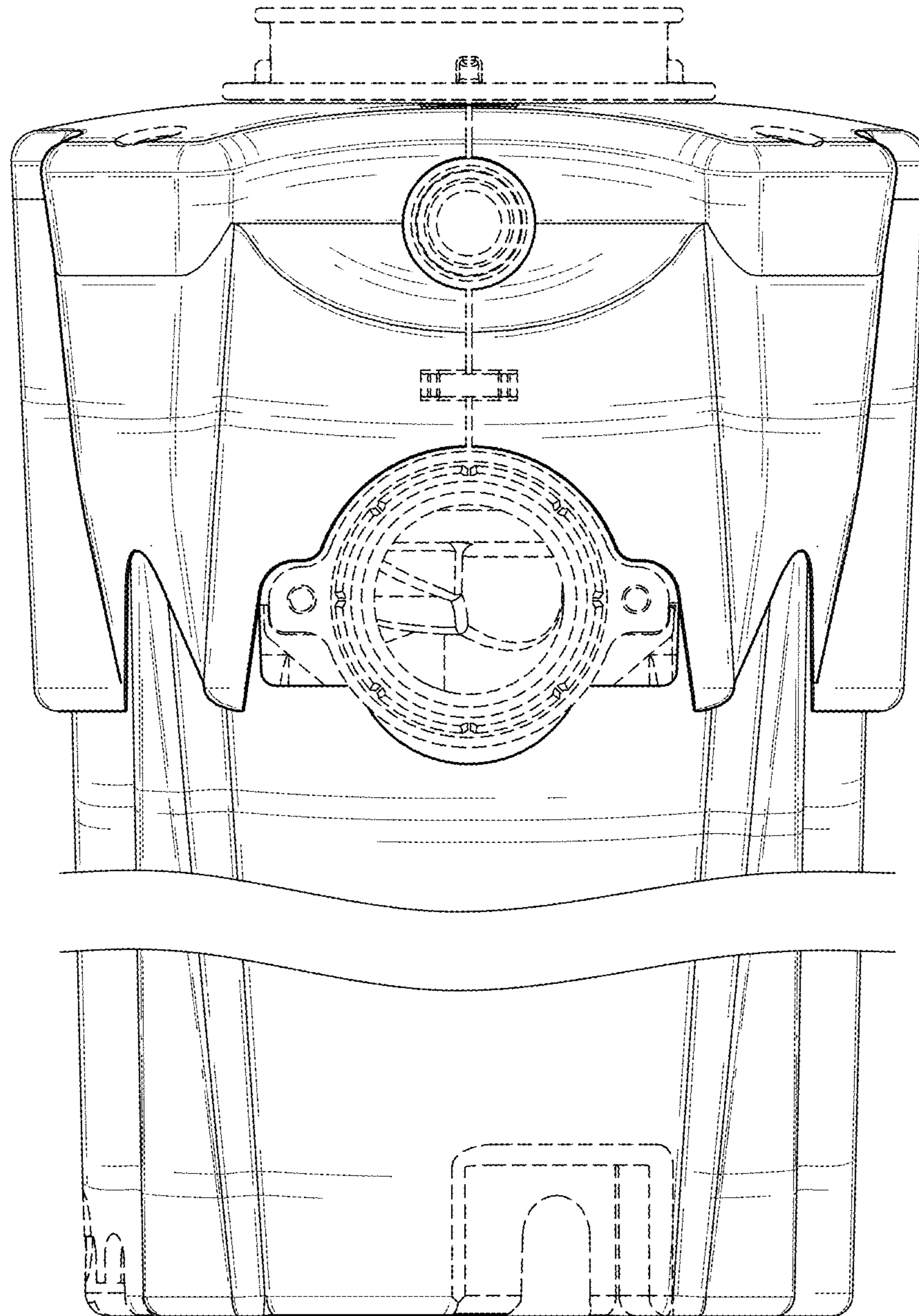

Fig-44

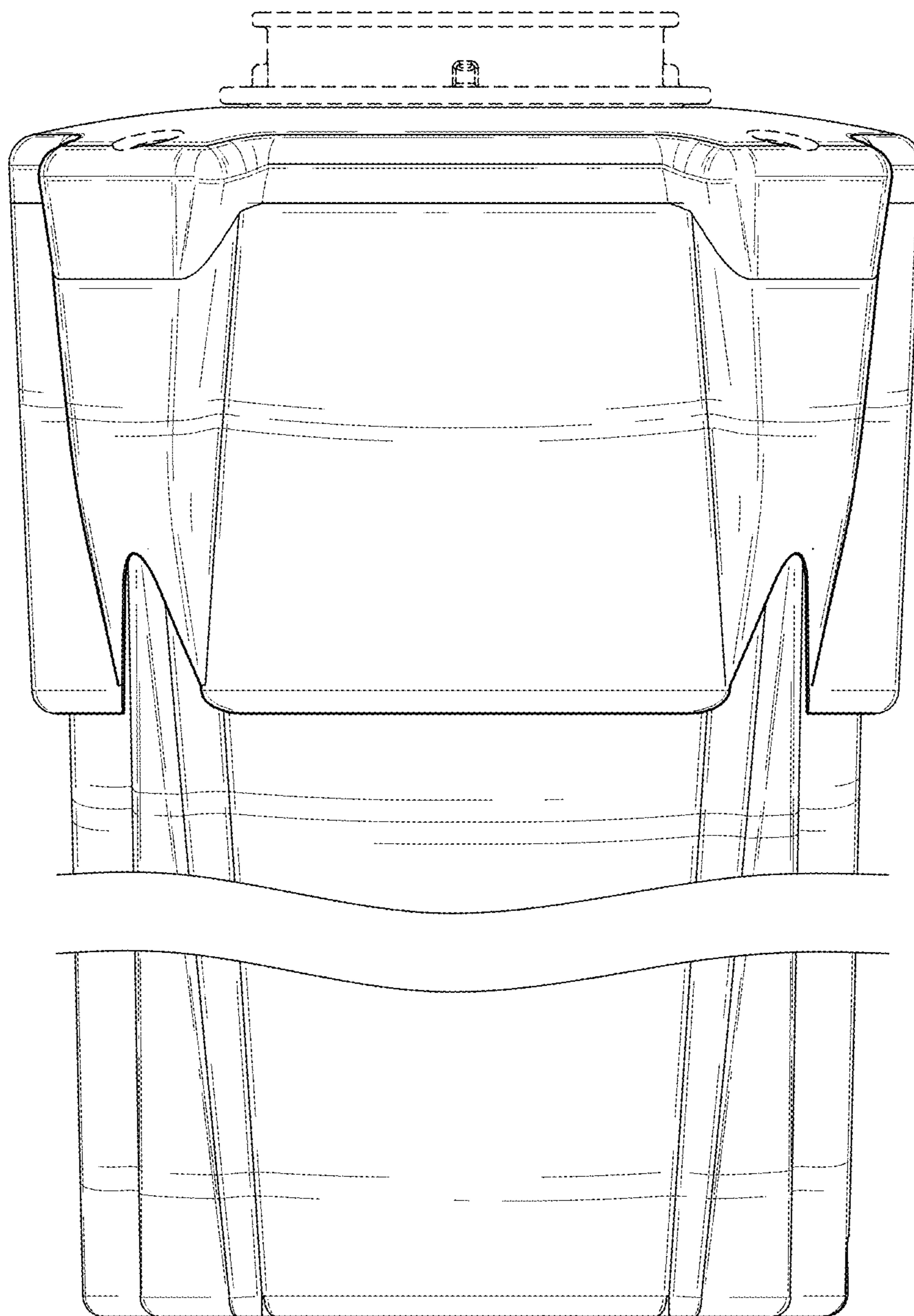

Fig-45

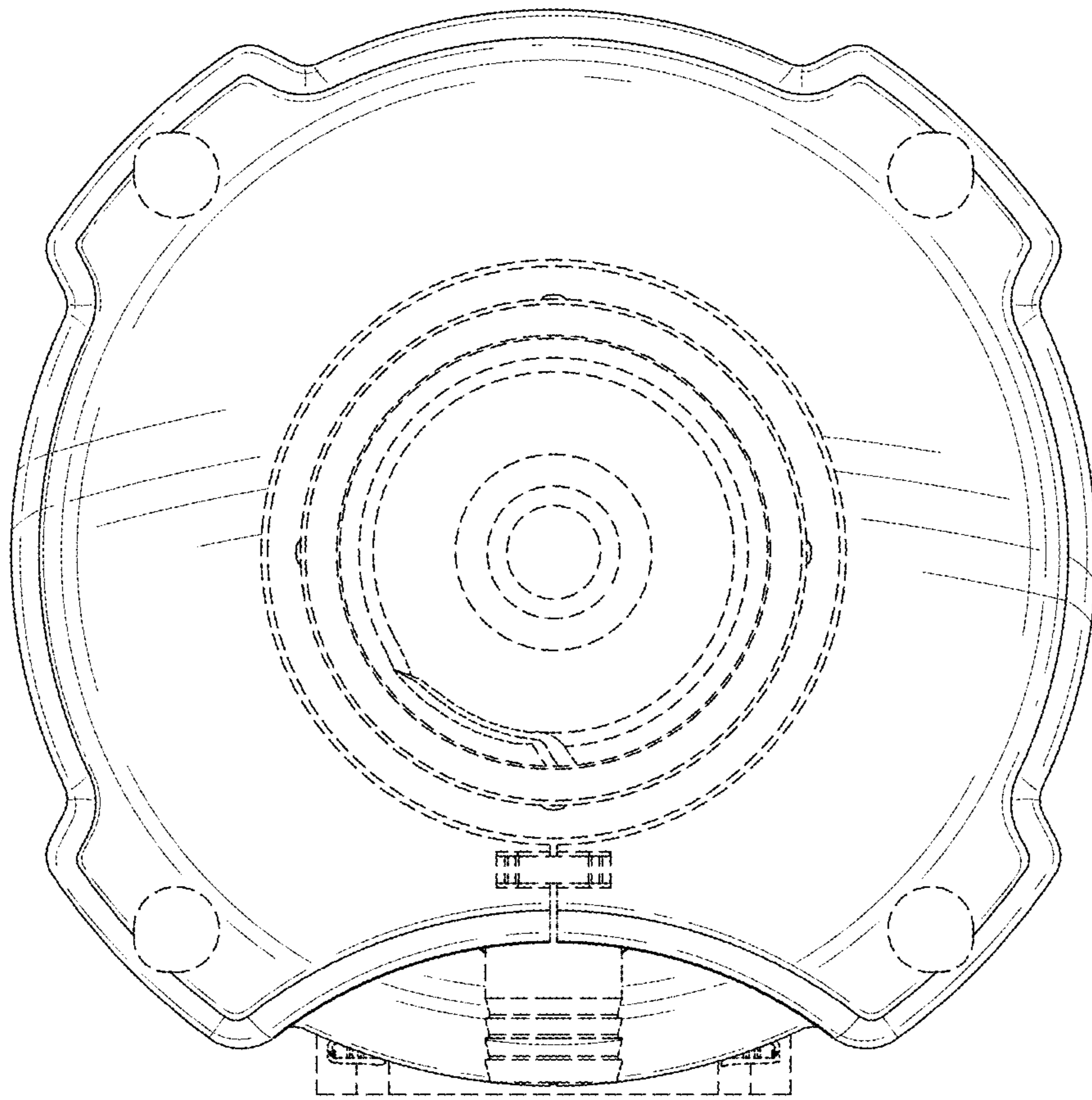

Fig-46



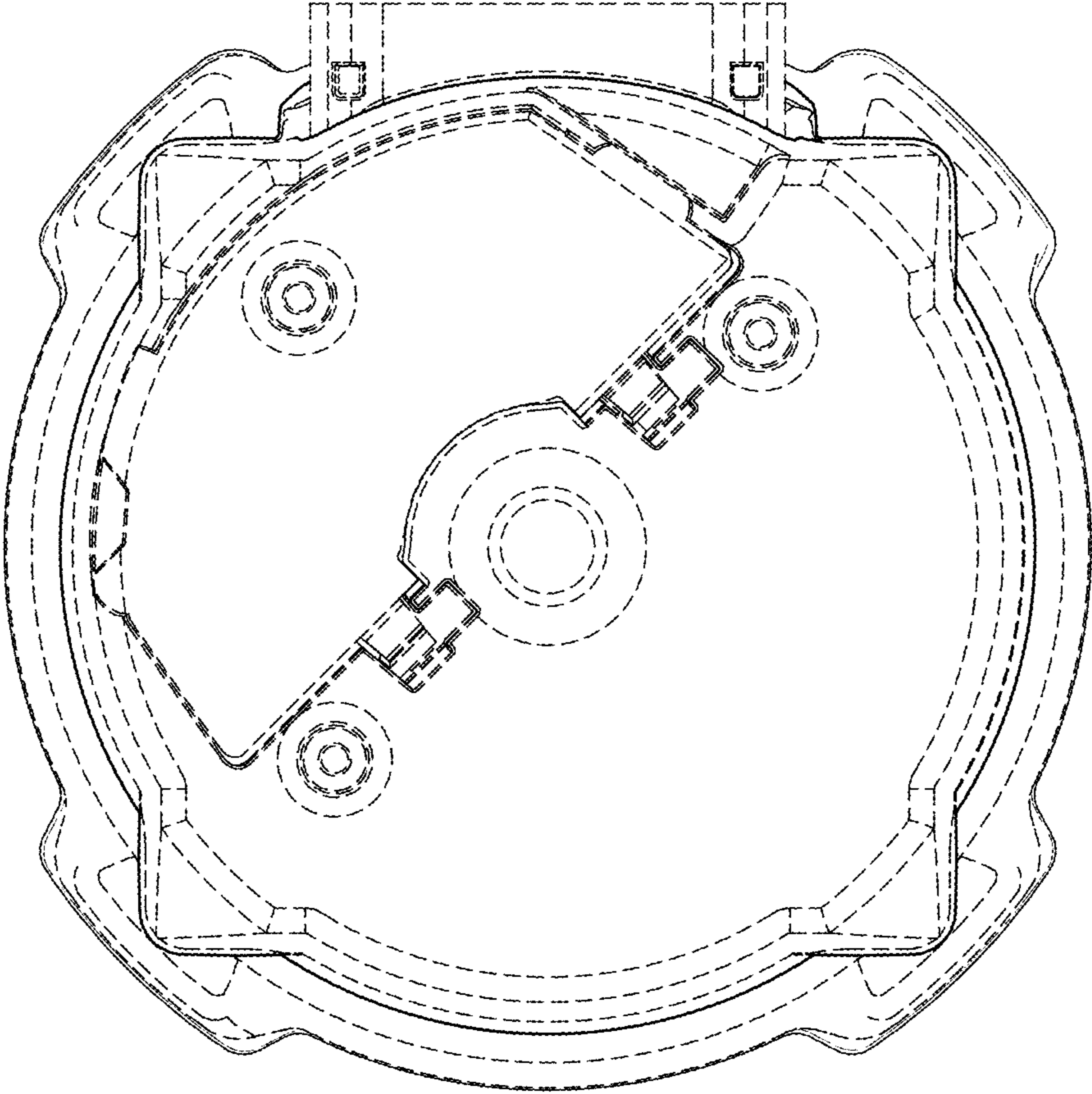

Fig-47

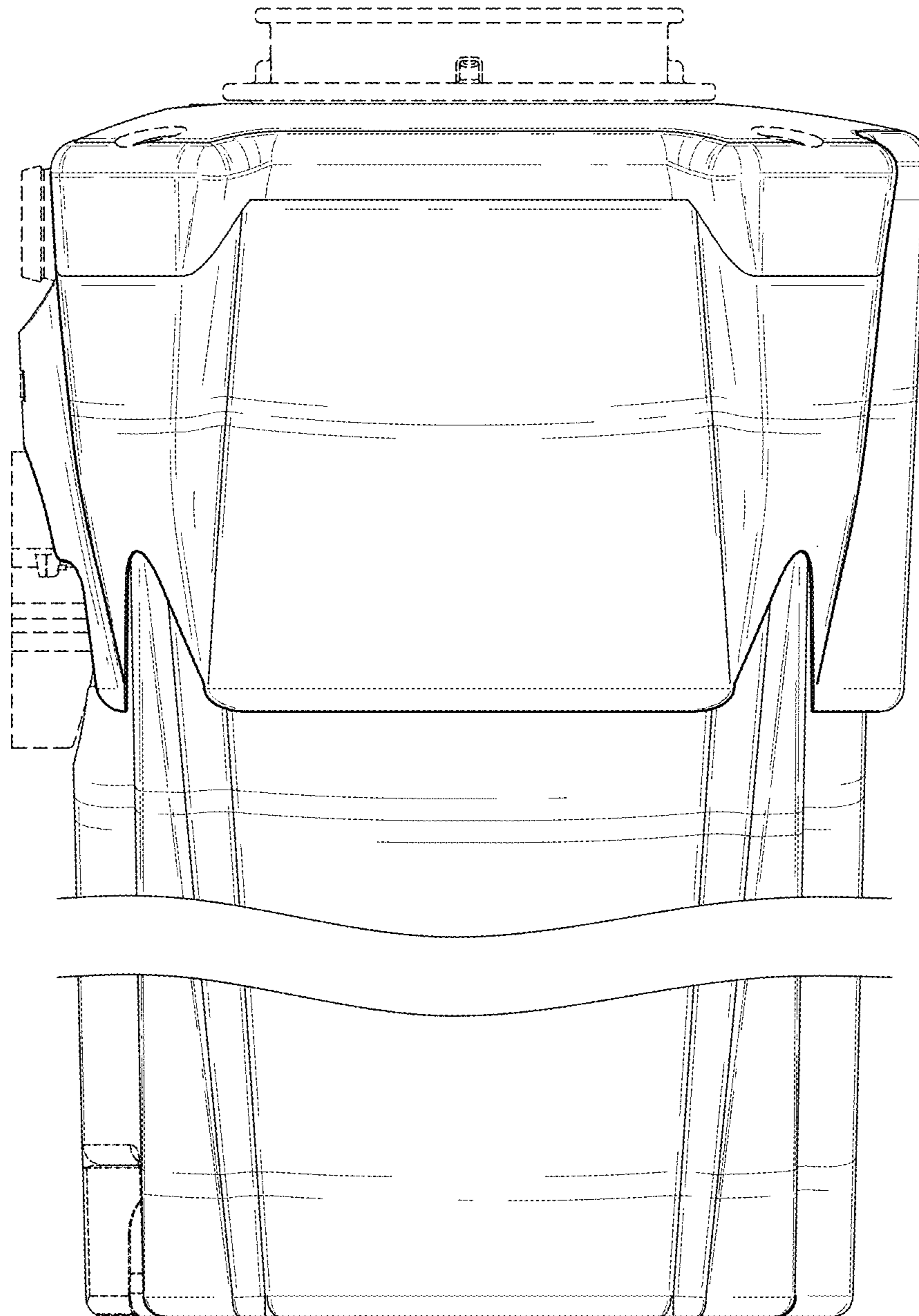

Fig-48

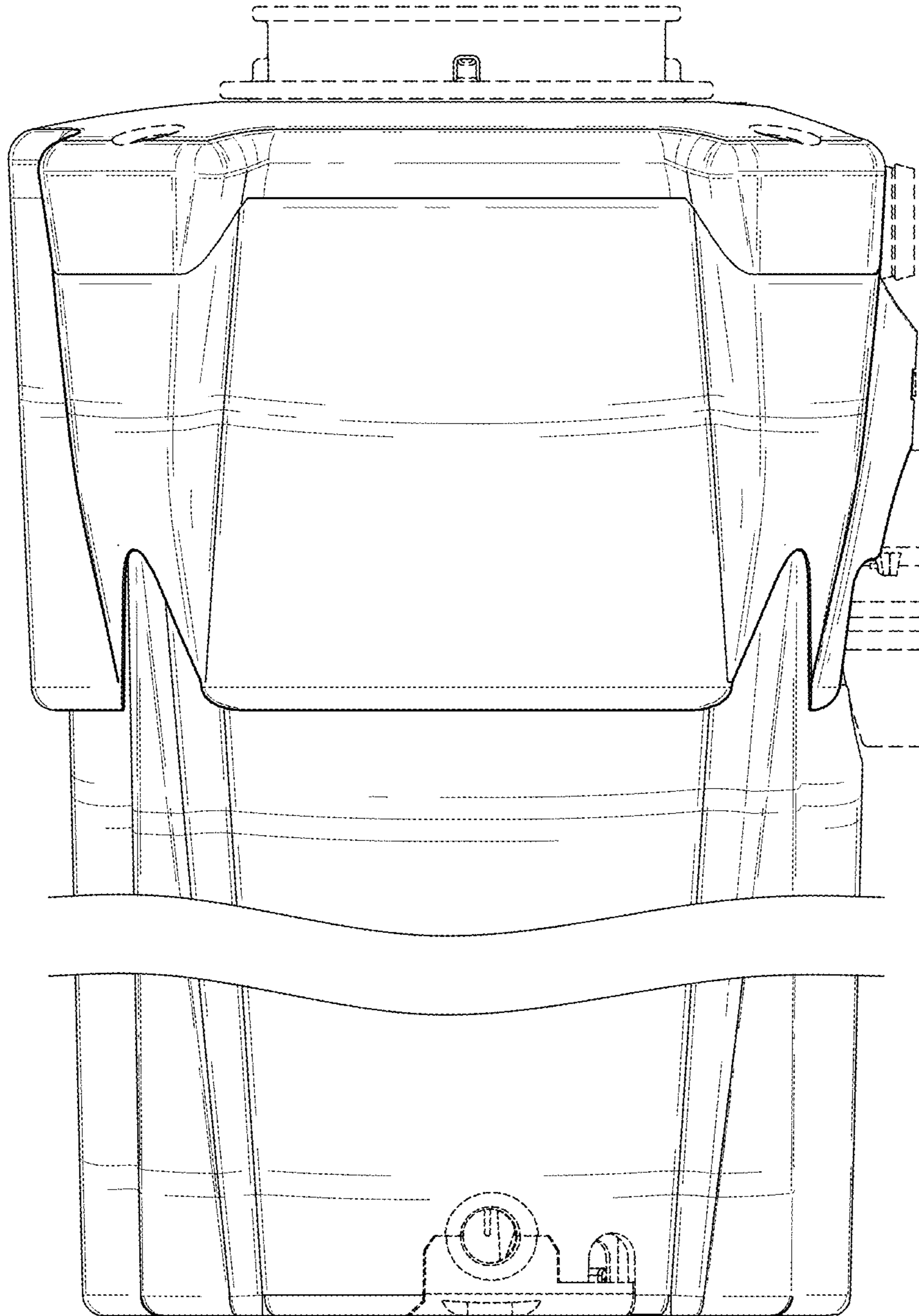

Fig-49

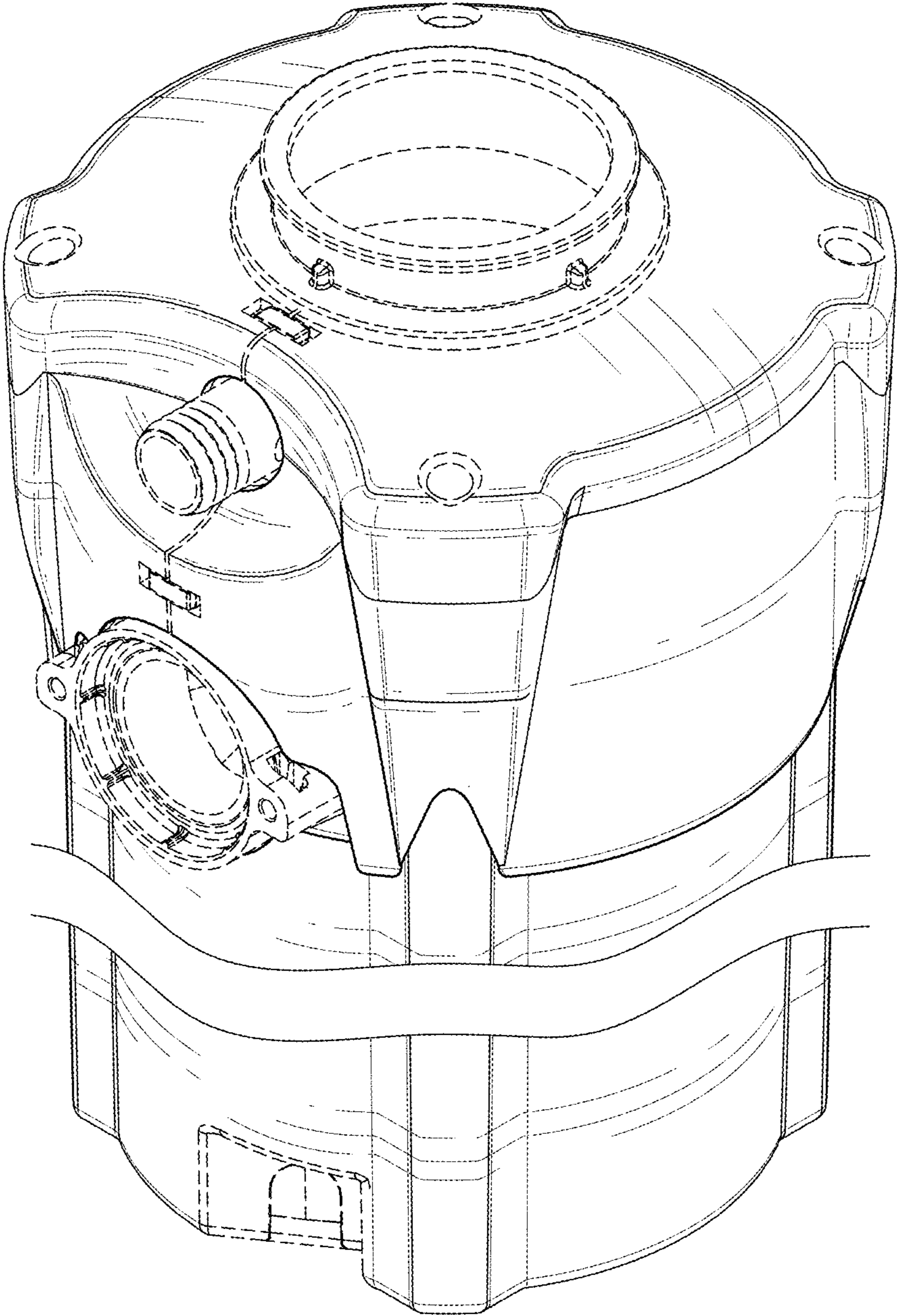

Fig-50



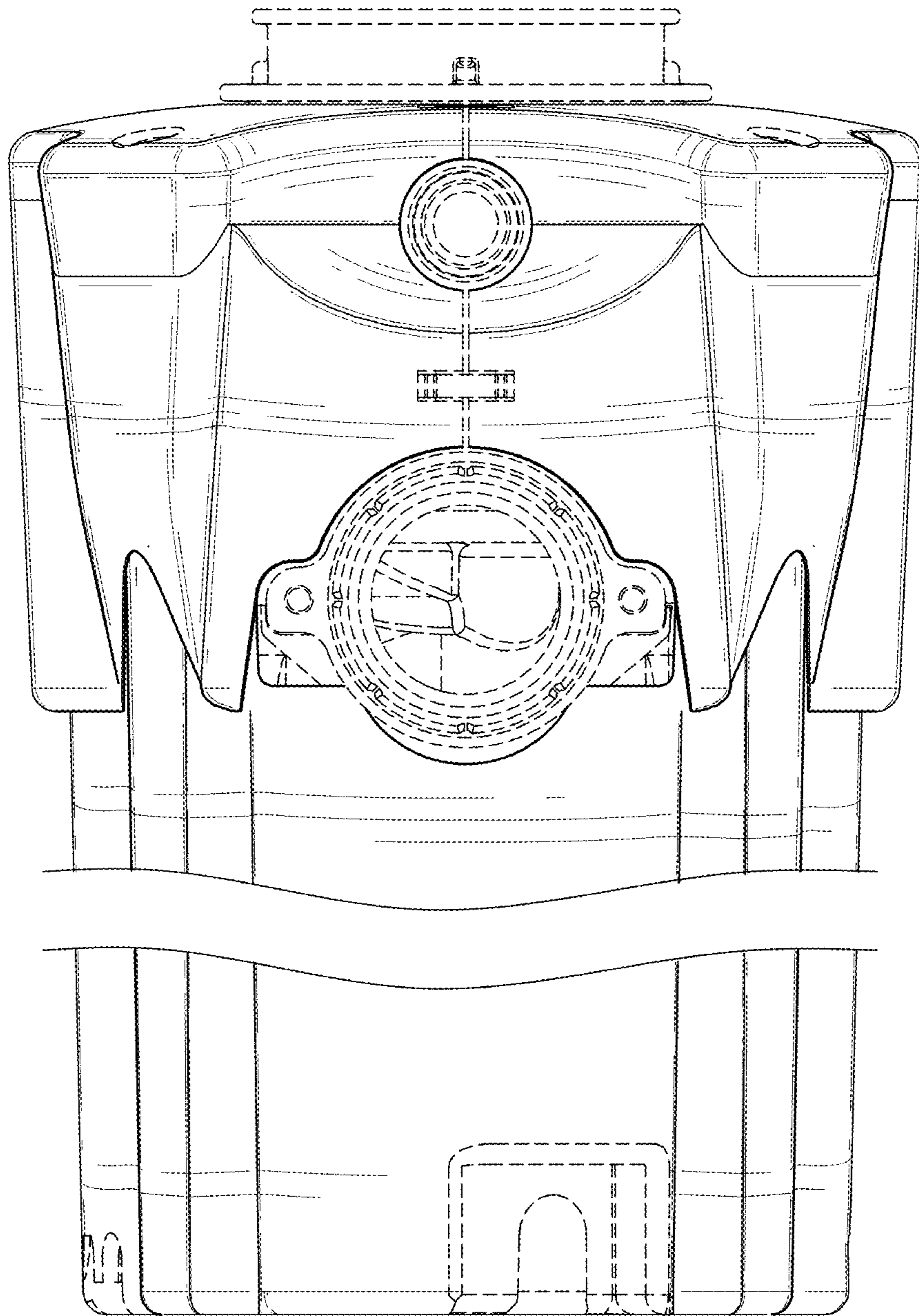

Fig-51

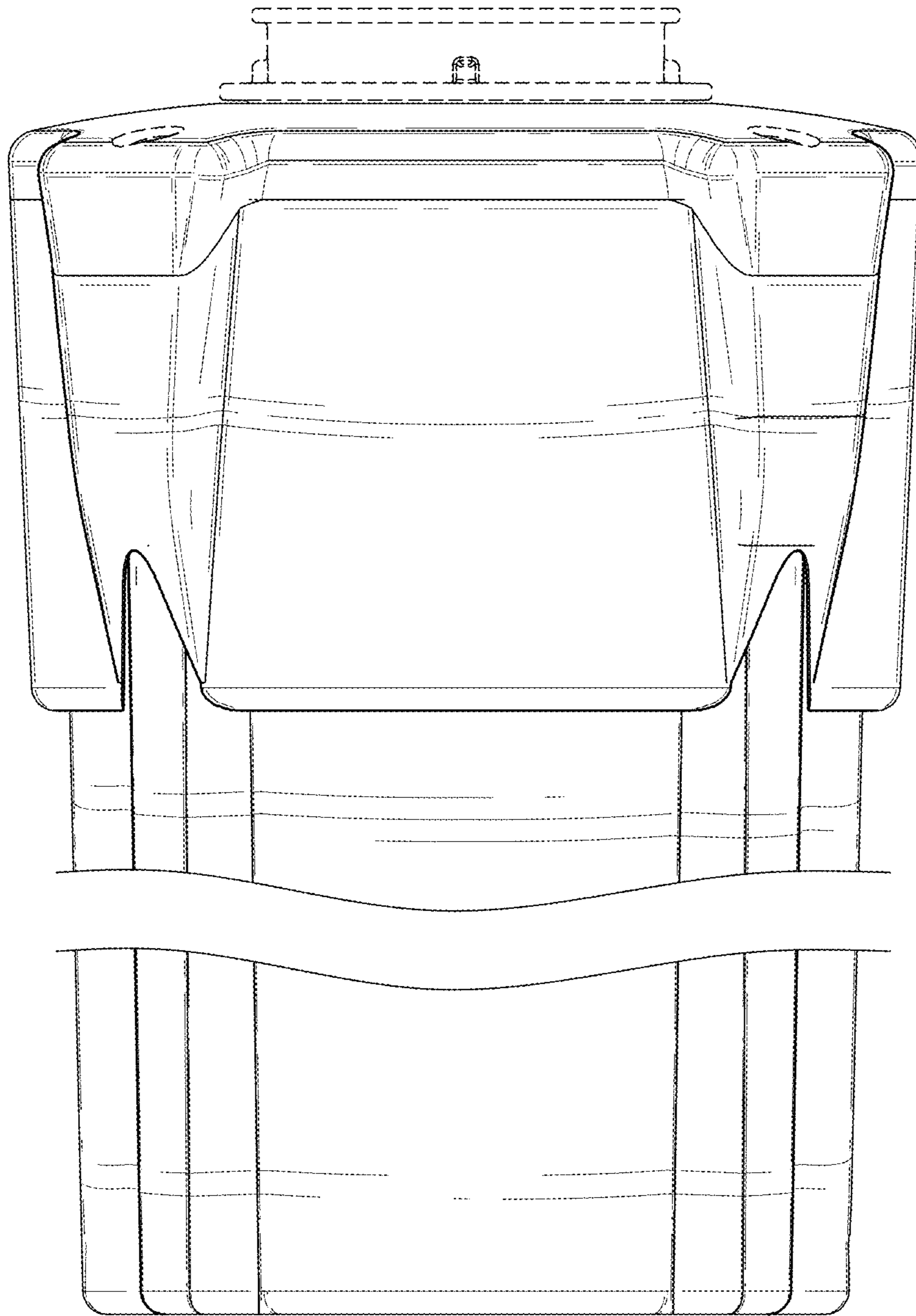

Fig-52

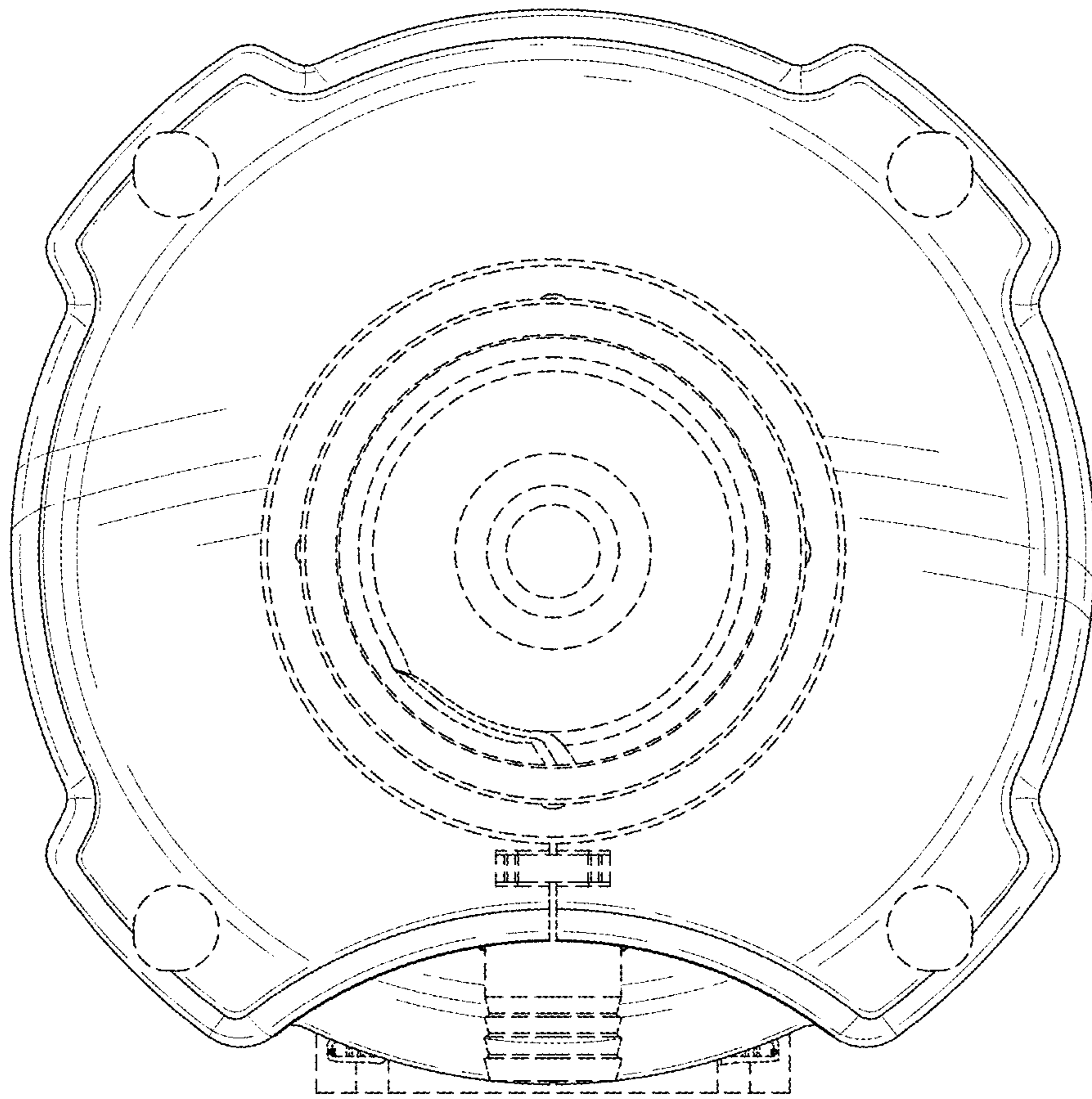

Fig-53

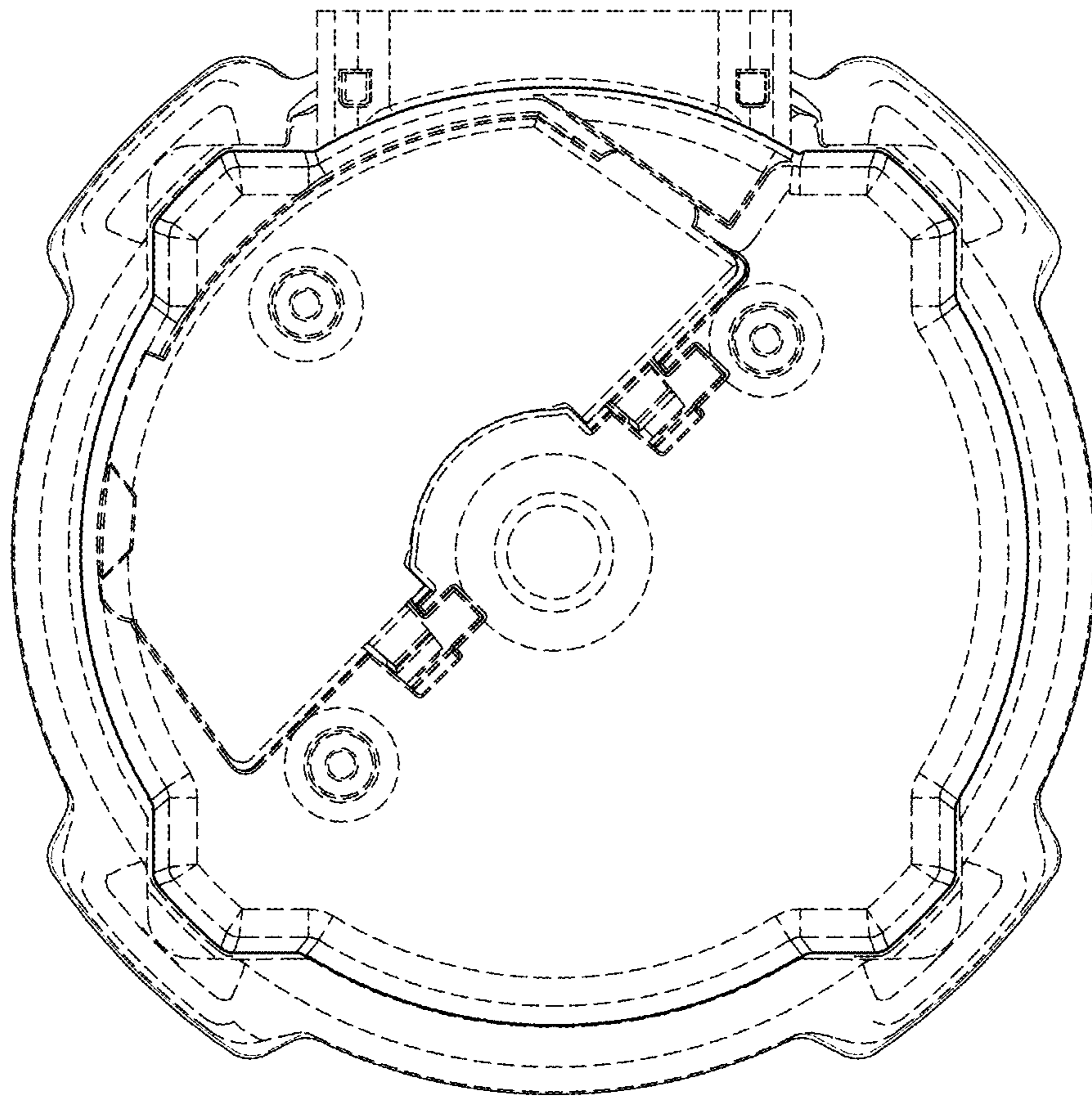

Fig-54



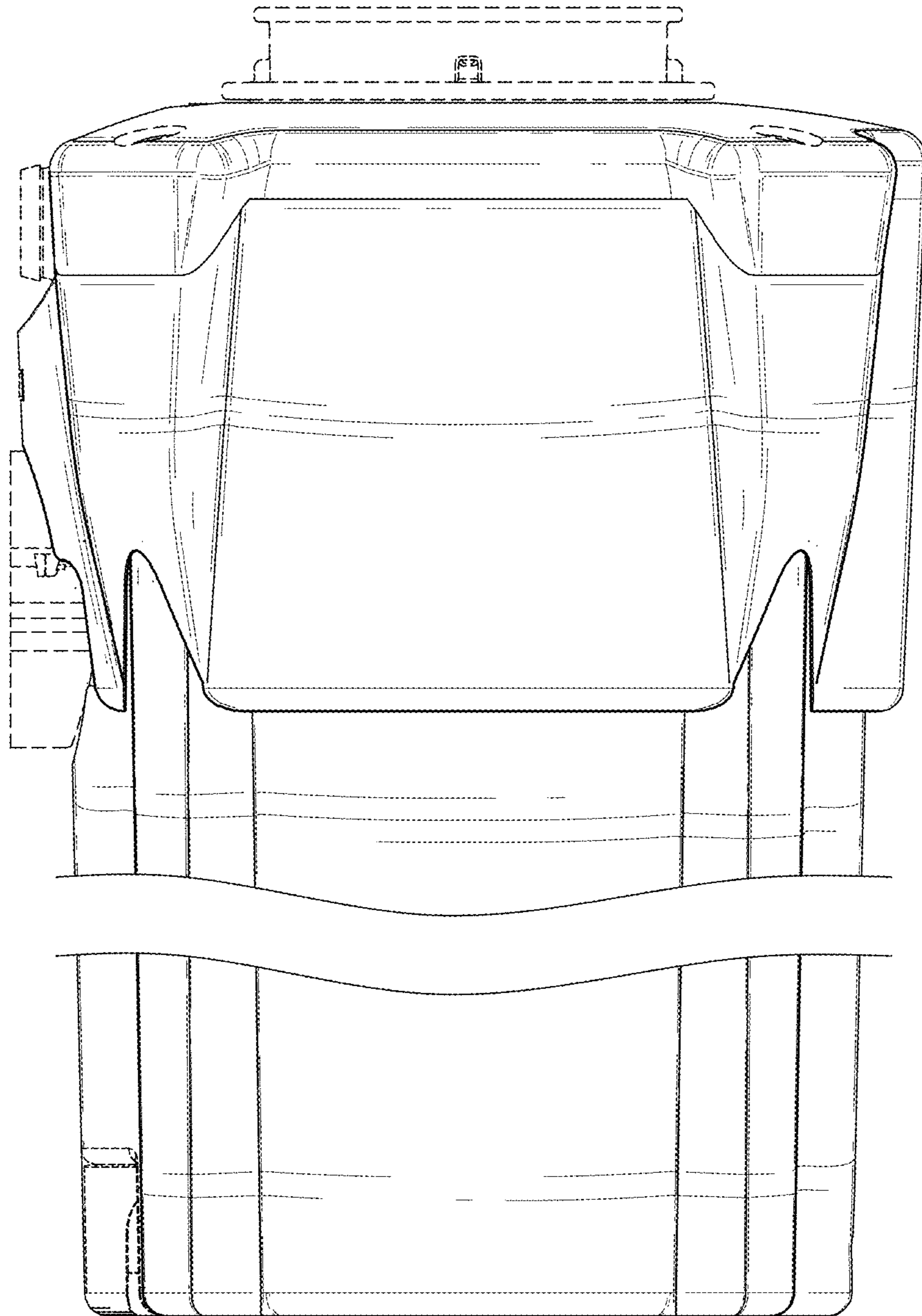

Fig-55

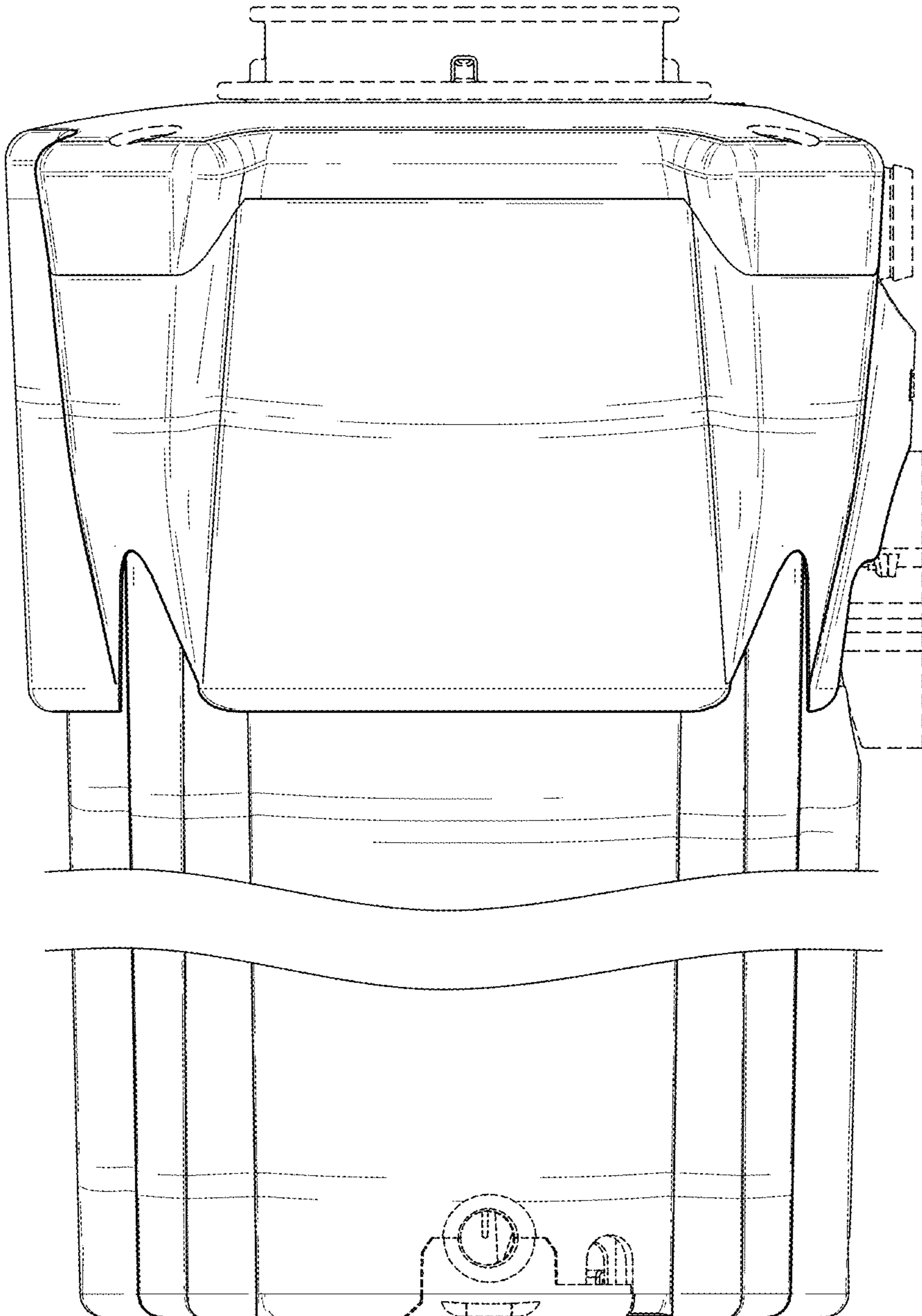

Fig-56