



US00D745954S

(12) **United States Design Patent**
de Siqueira Indio da Costa et al.

(10) **Patent No.:** **US D745,954 S**

(45) **Date of Patent:** **** Dec. 22, 2015**

(54) **AIR PURIFIER WITH GRAPHICAL USER INTERFACE**

D498,296 S * 11/2004 Shimizu D23/364
D529,154 S * 9/2006 Koike D23/333
D539,403 S * 3/2007 Pino D23/351

(71) Applicant: **Kinetic Solutions, Inc.**, Downey, CA (US)

(Continued)

(72) Inventors: **Luiz Augusto de Siqueira Indio da Costa**, Rio de Janeiro (BR); **Till Pupak**, Rio de Janeiro (BR)

Primary Examiner — Eric Goodman

Assistant Examiner — Bao-Yen Nguyen

(74) *Attorney, Agent, or Firm* — John Alumit

(73) Assignee: **KINETIC SOLUTIONS, INC.**, Downey, CA (US)

(57) **CLAIM**

We claim the ornamental design for an air purifier with graphical user interface, as shown and described herein.

(**) Term: **14 Years**

DESCRIPTION

(21) Appl. No.: **29/458,299**

FIG. 1 is a perspective view of an air purifier with a graphical user interface in an “off” mode according to our new design;

FIG. 2 is a perspective view of an air purifier with a graphical user interface of FIG. 1 in a first “on” mode;

FIG. 3 is a close up perspective view of the air purifier with a graphical user interface of FIG. 1;

(22) Filed: **Jun. 18, 2013**

FIG. 4 is a front view of the air purifier with a graphical user interface of FIG. 1;

(51) **LOC (10) Cl.** **23-04**

(52) **U.S. Cl.**

USPC **D23/355**

FIG. 5 is a right side view of the air purifier with a graphical user interface of FIG. 1;

(58) **Field of Classification Search**

USPC D23/314, 325, 329, 333, 334, 335, 342, D23/355, 356, 358, 359, 364, 386, 387, 388, D23/389, 390, 391; D14/356, 362

FIG. 6 is a left side view of the air purifier with a graphical user interface of FIG. 1;

CPC A61L 9/00; A61L 9/20; A61L 9/205; A61L 9/01; A61L 9/015; A61L 9/14; A61L 9/16; F24F 1/00; F24F 3/16; F24F 3/166; F24F 3/1603; F24F 3/14; F24F 3/12; F24F 7/00; B03C 1/00; B03C 3/32; B03C 3/15; B03C 3/155; B03C 3/16

FIG. 7 is a rear view of the air purifier with a graphical user interface of FIG. 1;

See application file for complete search history.

FIG. 8 is a top view of the air purifier with a graphical user interface of FIG. 1;

FIG. 9 is a perspective view of the air purifier with a graphical user interface of FIG. 1 in a second “on” mode;

FIG. 10 is a close up perspective view of the air purifier with a graphical user interface of FIG. 2;

FIG. 11 is a perspective view of the air purifier with a graphical user interface of FIG. 1 in a third “on” mode;

FIG. 12 is a front view of the air purifier with a graphical user interface of FIG. 1; and,

FIG. 13 is an enlarged view of the air purifier with a graphical user interface of FIG. 12.

(56) **References Cited**

U.S. PATENT DOCUMENTS

D353,885 S * 12/1994 Hydak et al. D23/381
6,461,396 B1 * 10/2002 Barker et al. 55/471
D465,567 S * 11/2002 Choi D23/364

1 Claim, 12 Drawing Sheets

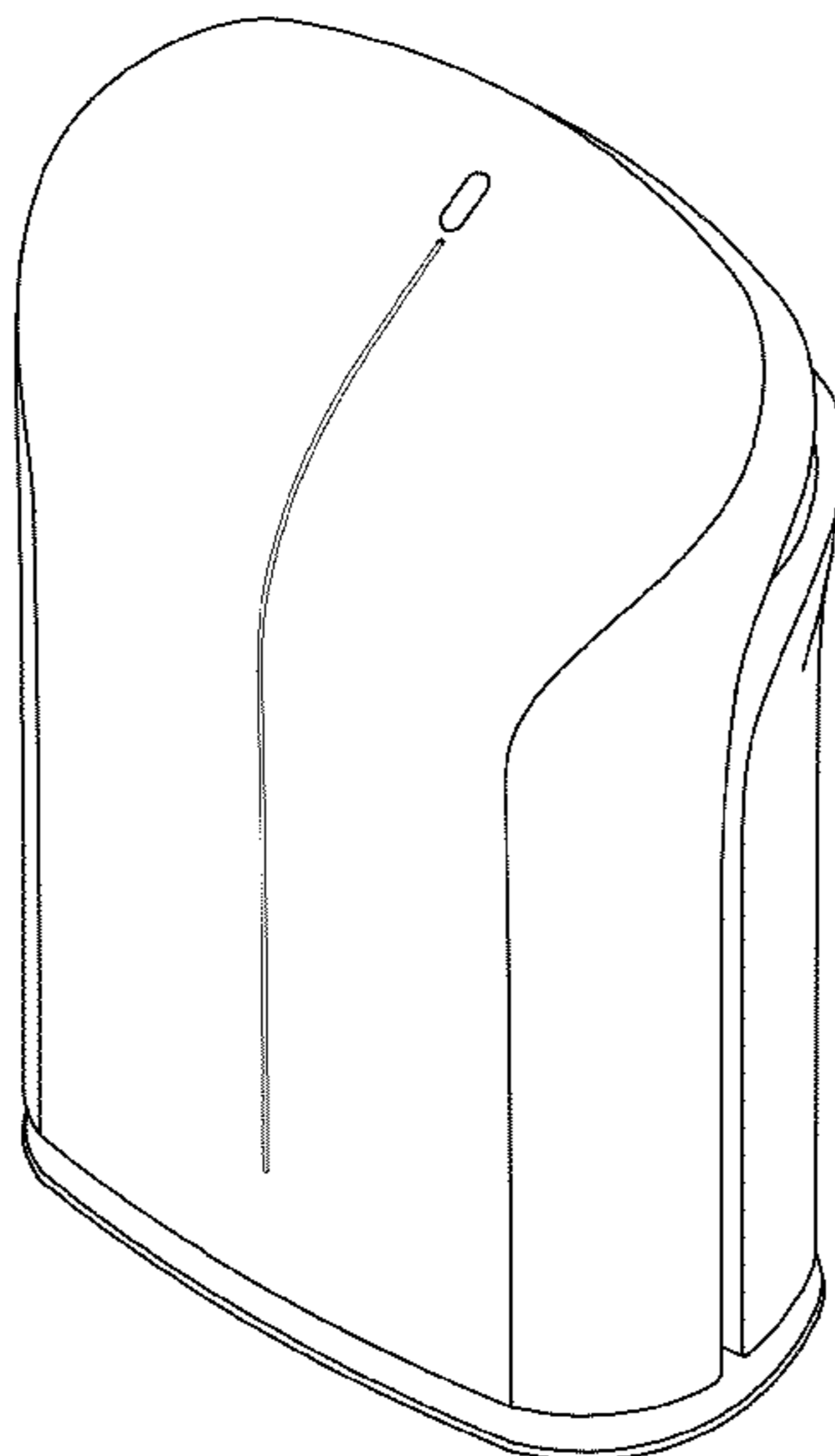

(56)

References Cited

U.S. PATENT DOCUMENTS

D548,825 S *	8/2007	Suzuki et al.	D23/364	D634,828 S *	3/2011	Nakamura	D23/355
D549,307 S *	8/2007	Chiu	D23/333	D639,921 S *	6/2011	Levano	D23/332
D550,343 S *	9/2007	Chen	D23/364	D643,520 S *	8/2011	Choi	D23/364
D577,800 S *	9/2008	Yoon	D23/359	D658,280 S *	4/2012	Niki et al.	D23/364
D578,192 S *	10/2008	Yoo et al.	D23/333	D662,577 S *	6/2012	Nakamura et al.	D23/364
D599,456 S *	9/2009	Choi	D23/364	D681,789 S *	5/2013	Chiu	D23/333
D599,896 S *	9/2009	Choi	D23/364	D683,439 S *	5/2013	Choi	D23/364
D603,497 S *	11/2009	Choi	D23/364	D683,839 S *	6/2013	Yamashita	D23/364
D608,434 S *	1/2010	Niki	D23/364	D684,247 S *	6/2013	Chouji	D23/364
D616,081 S *	5/2010	Chiu	D23/333	D687,532 S *	8/2013	Choi	D23/364
D625,398 S *	10/2010	Choi	D23/364	2003/0010001 A1 *	1/2003	Bryce et al.	55/467
				2006/0130450 A1 *	6/2006	Huang	55/471
				2006/0182429 A1 *	8/2006	Shapiro et al.	392/365

* cited by examiner

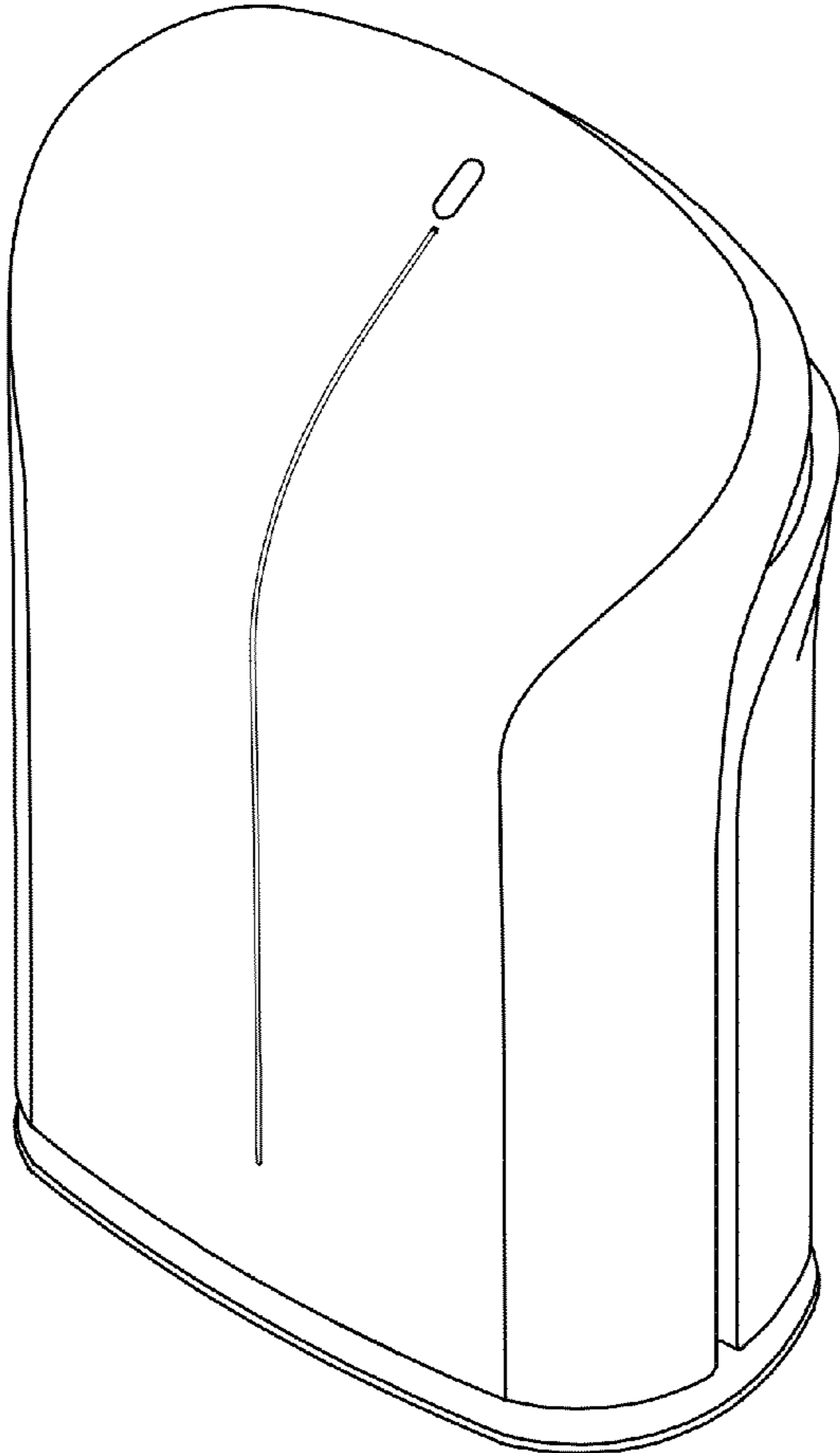

FIG. 1

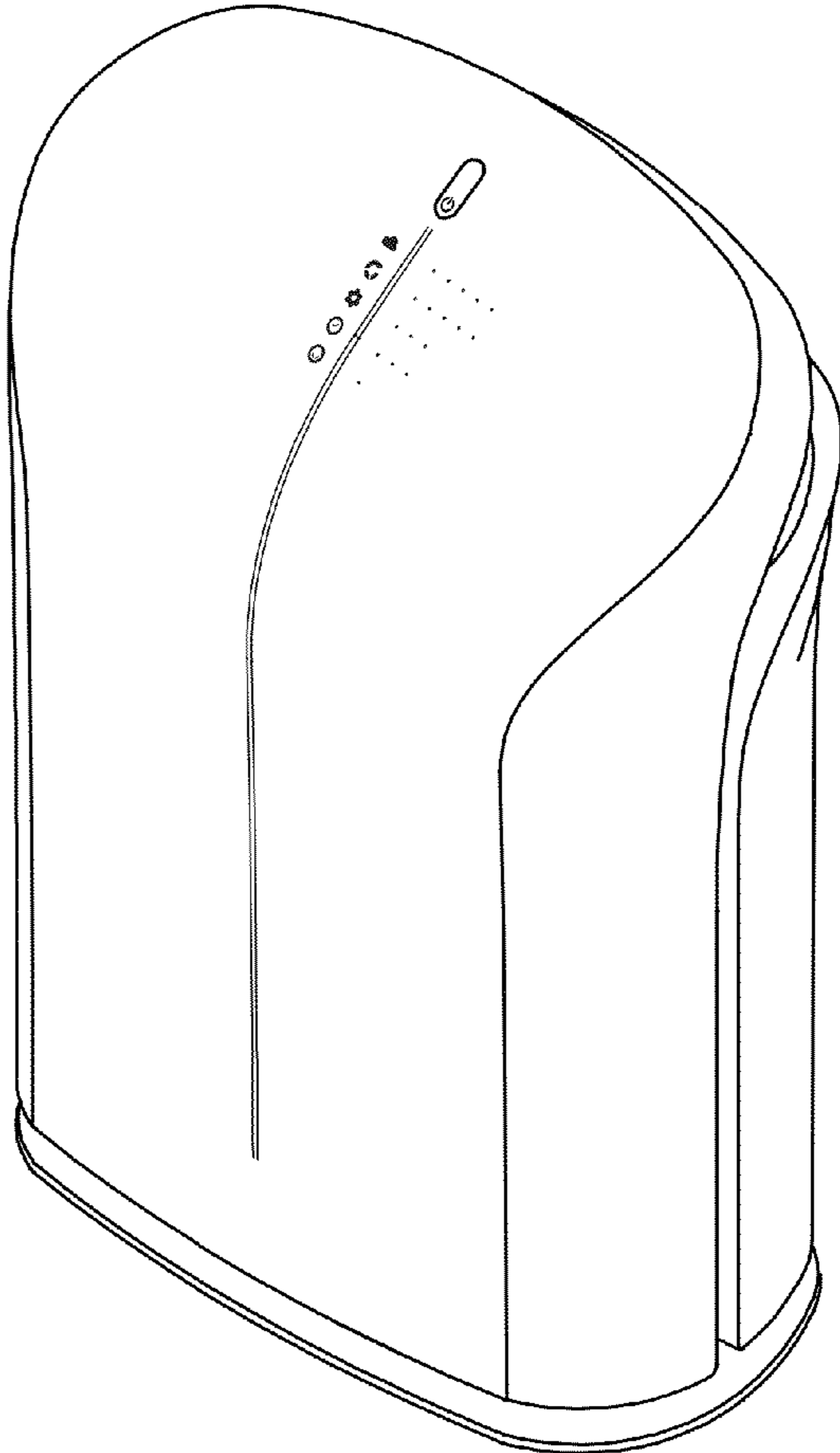

FIG. 2

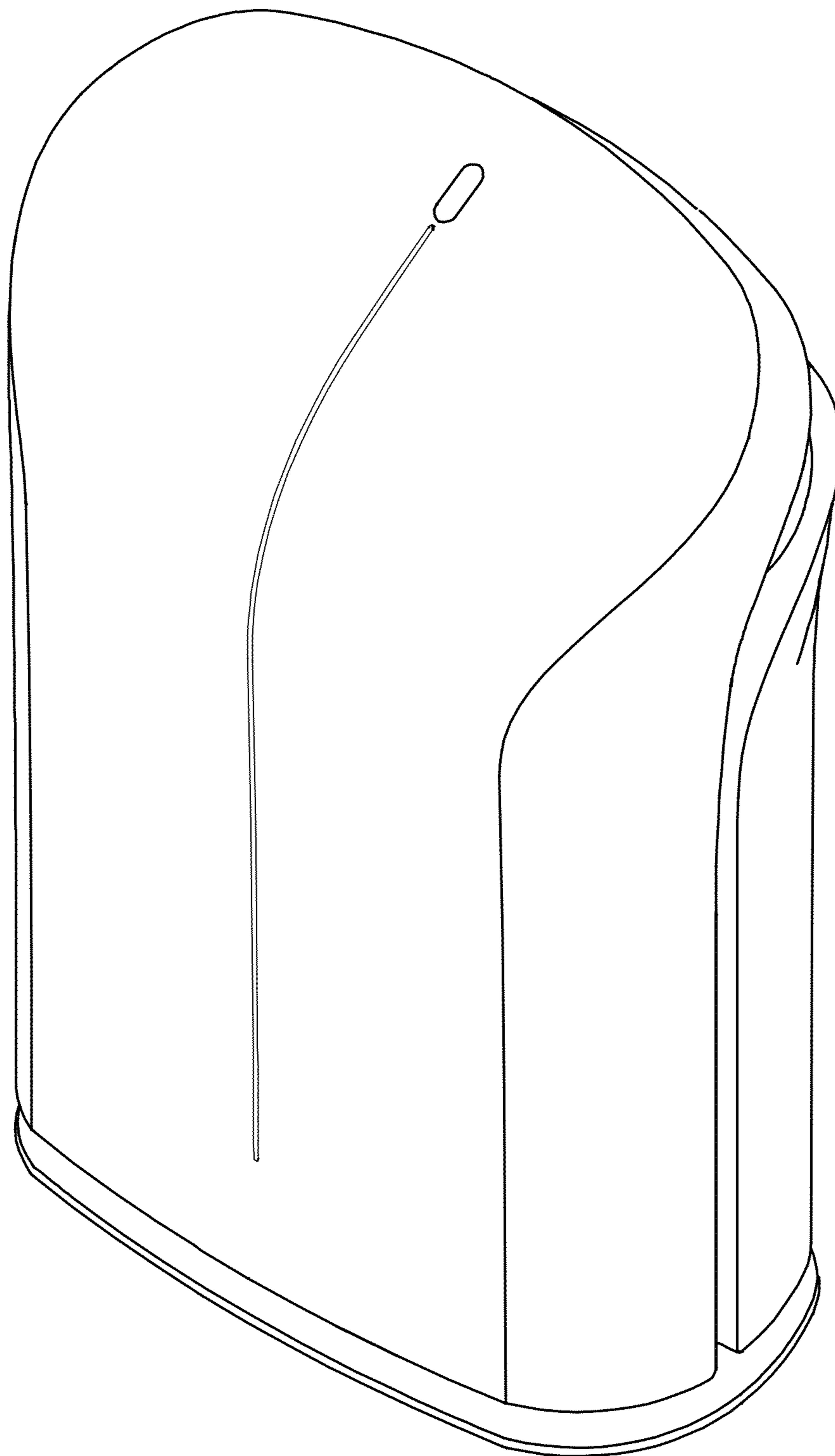

FIG. 3

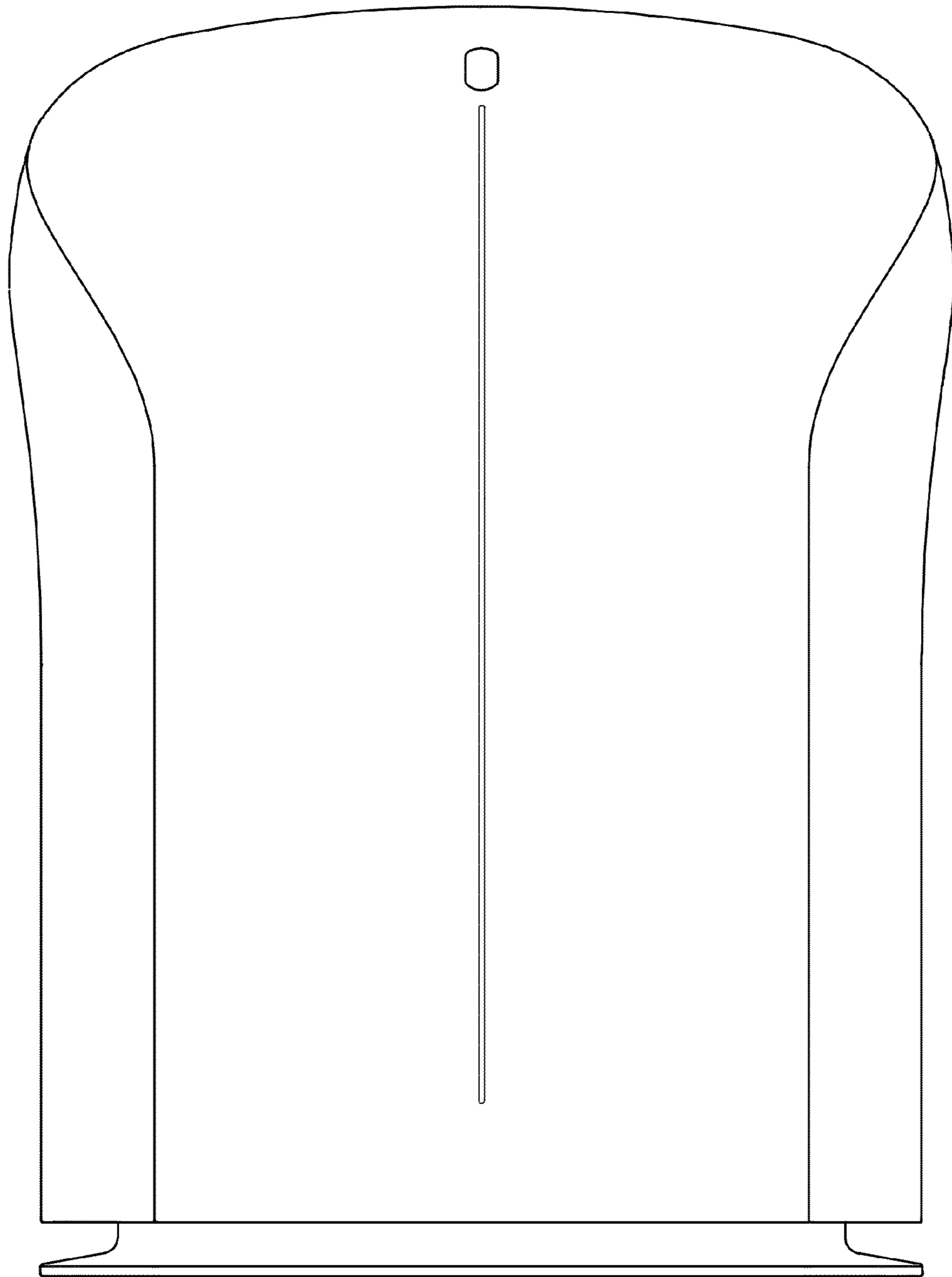

FIG. 4

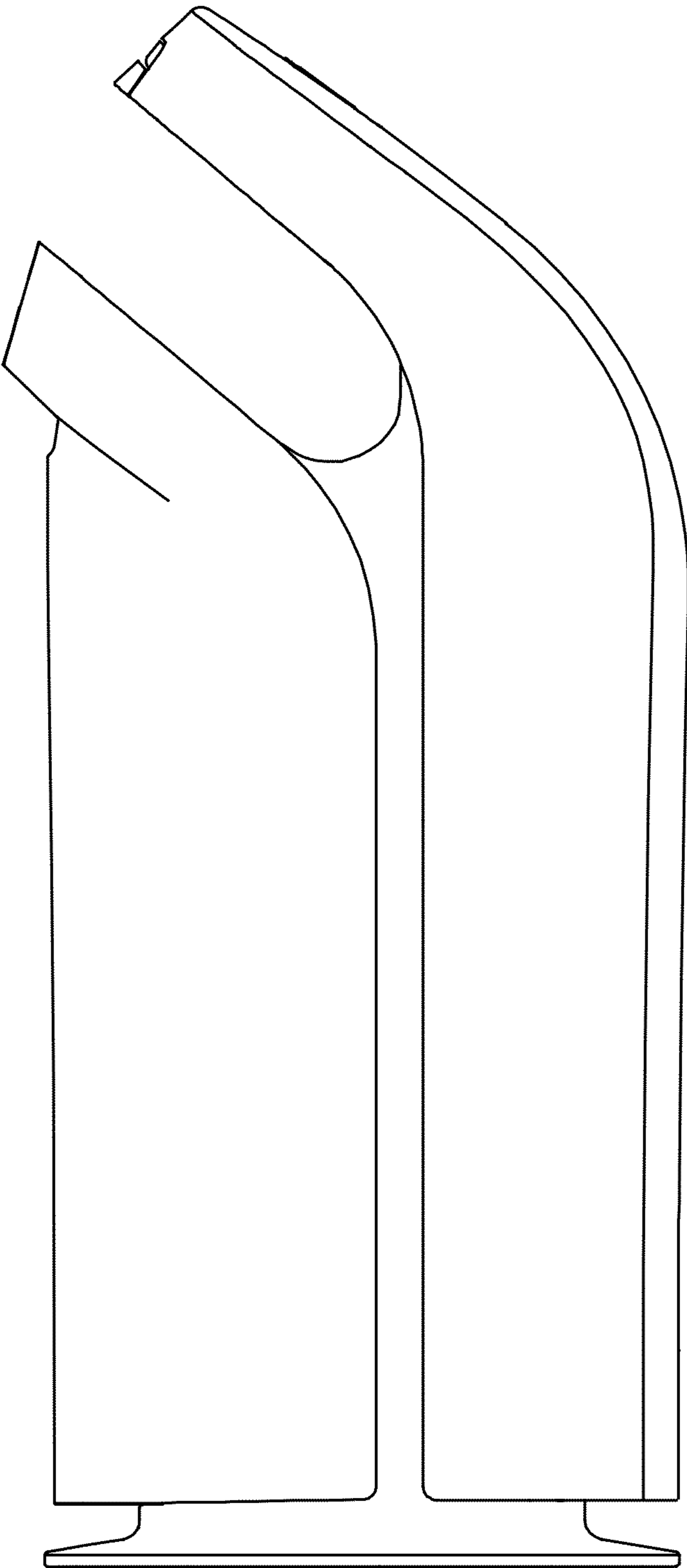

FIG. 5

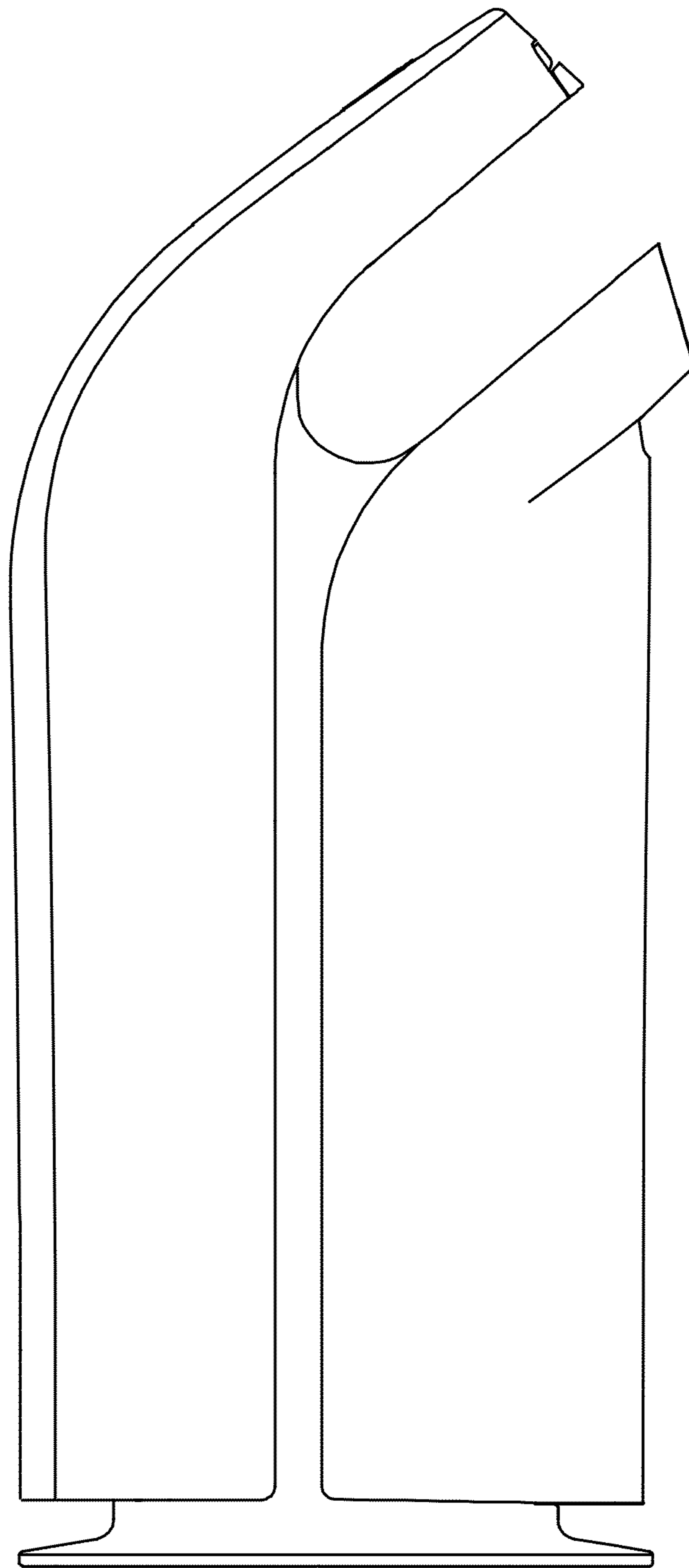

FIG. 6

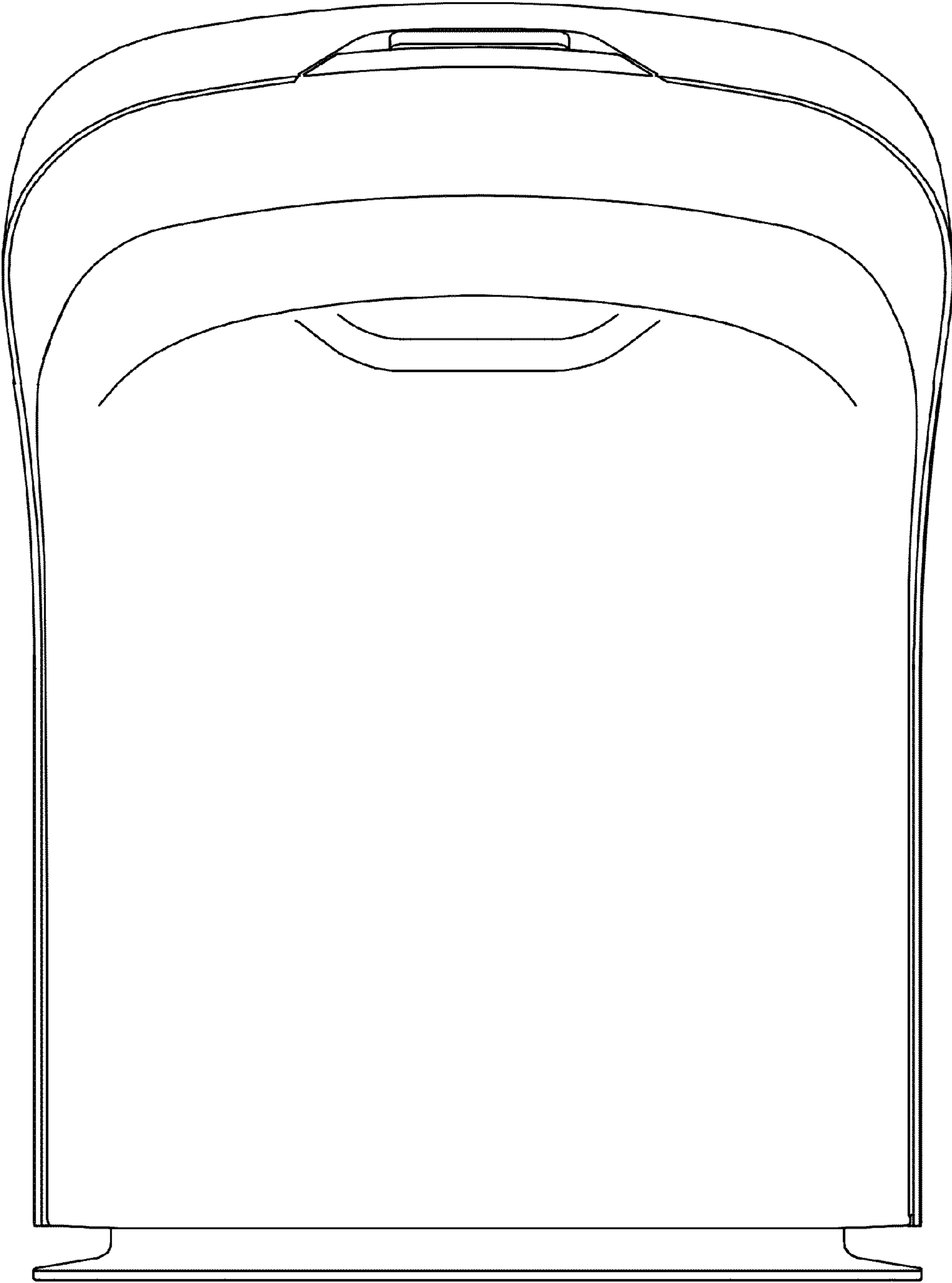

FIG. 7

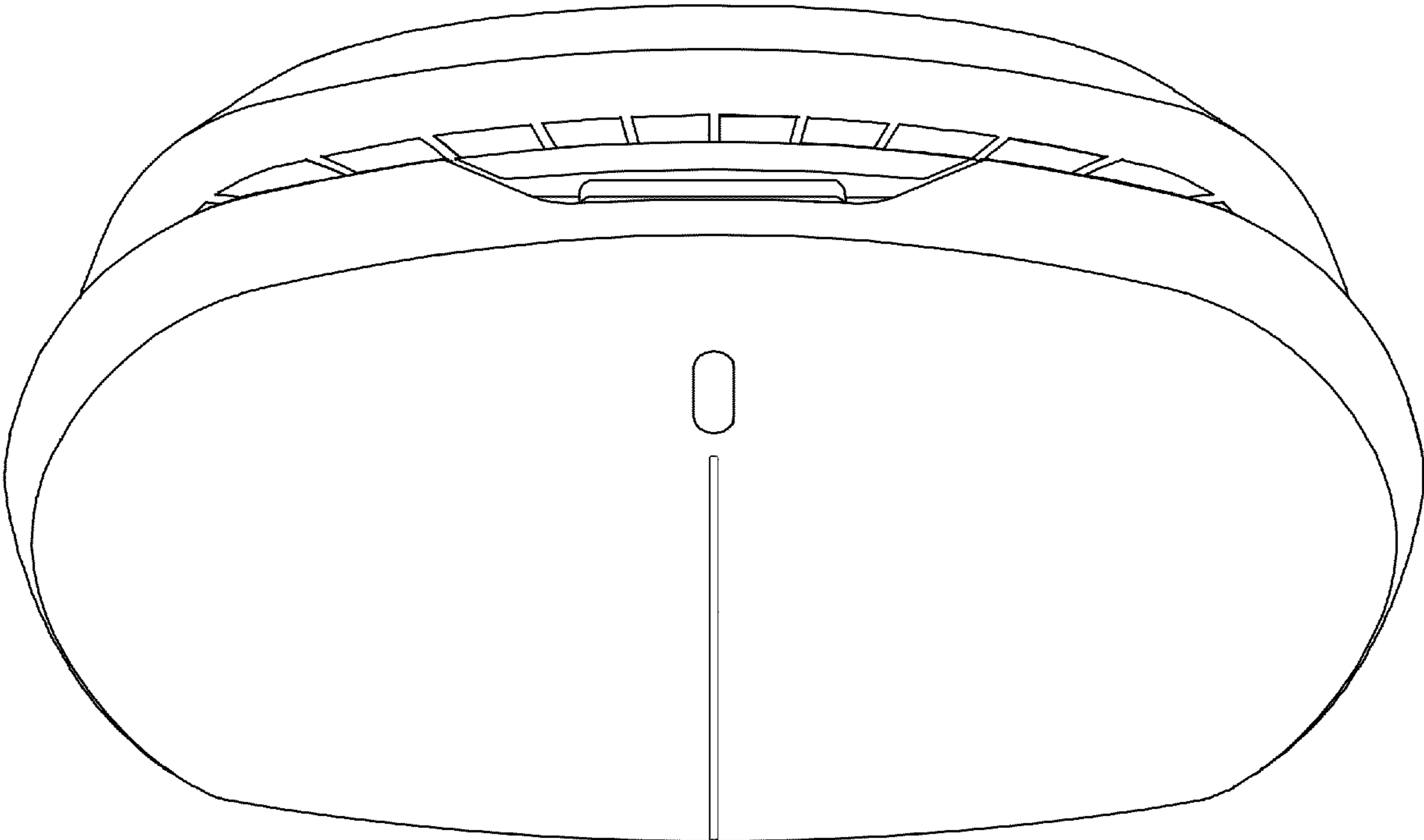

FIG. 8

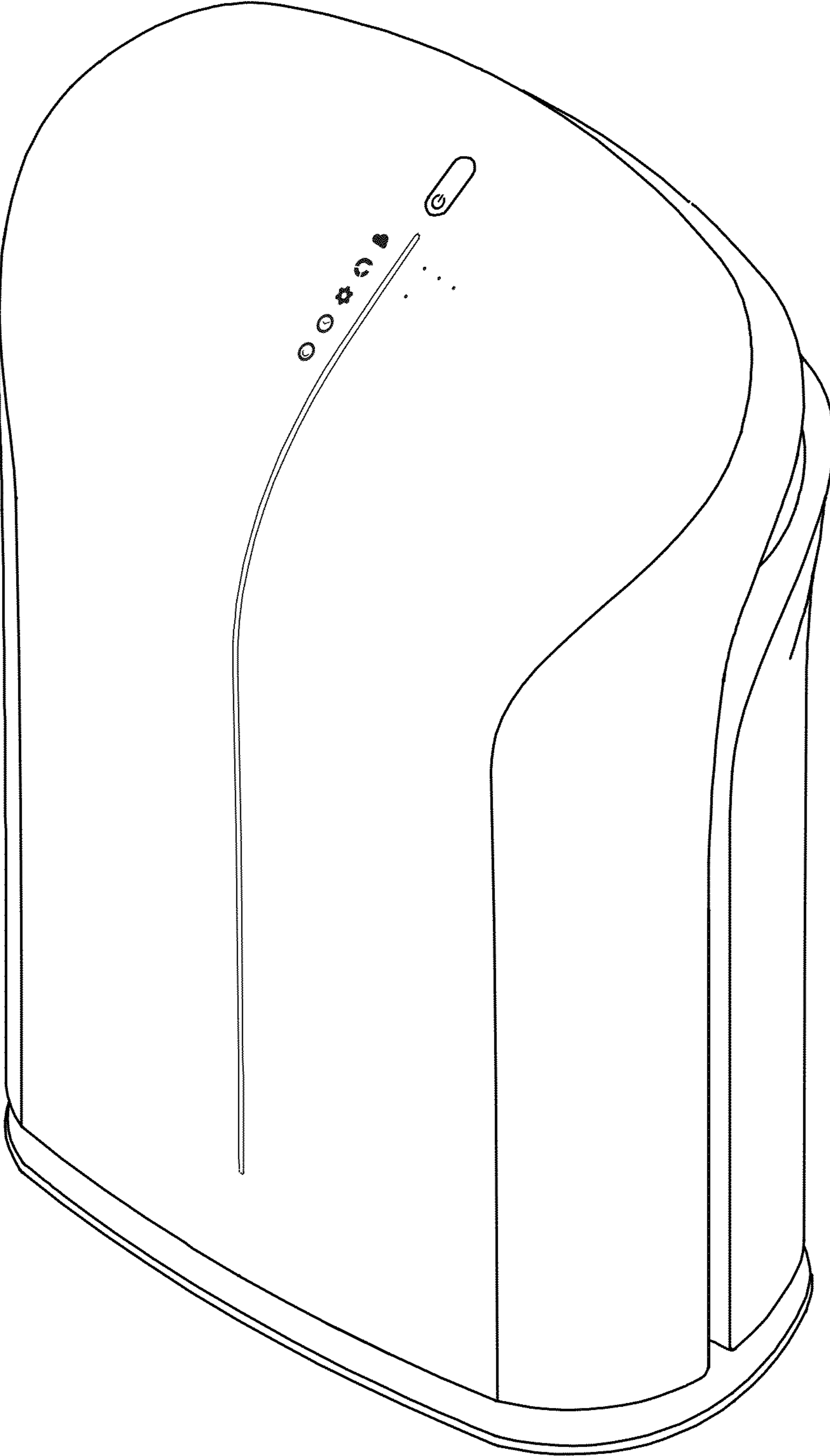

FIG. 9

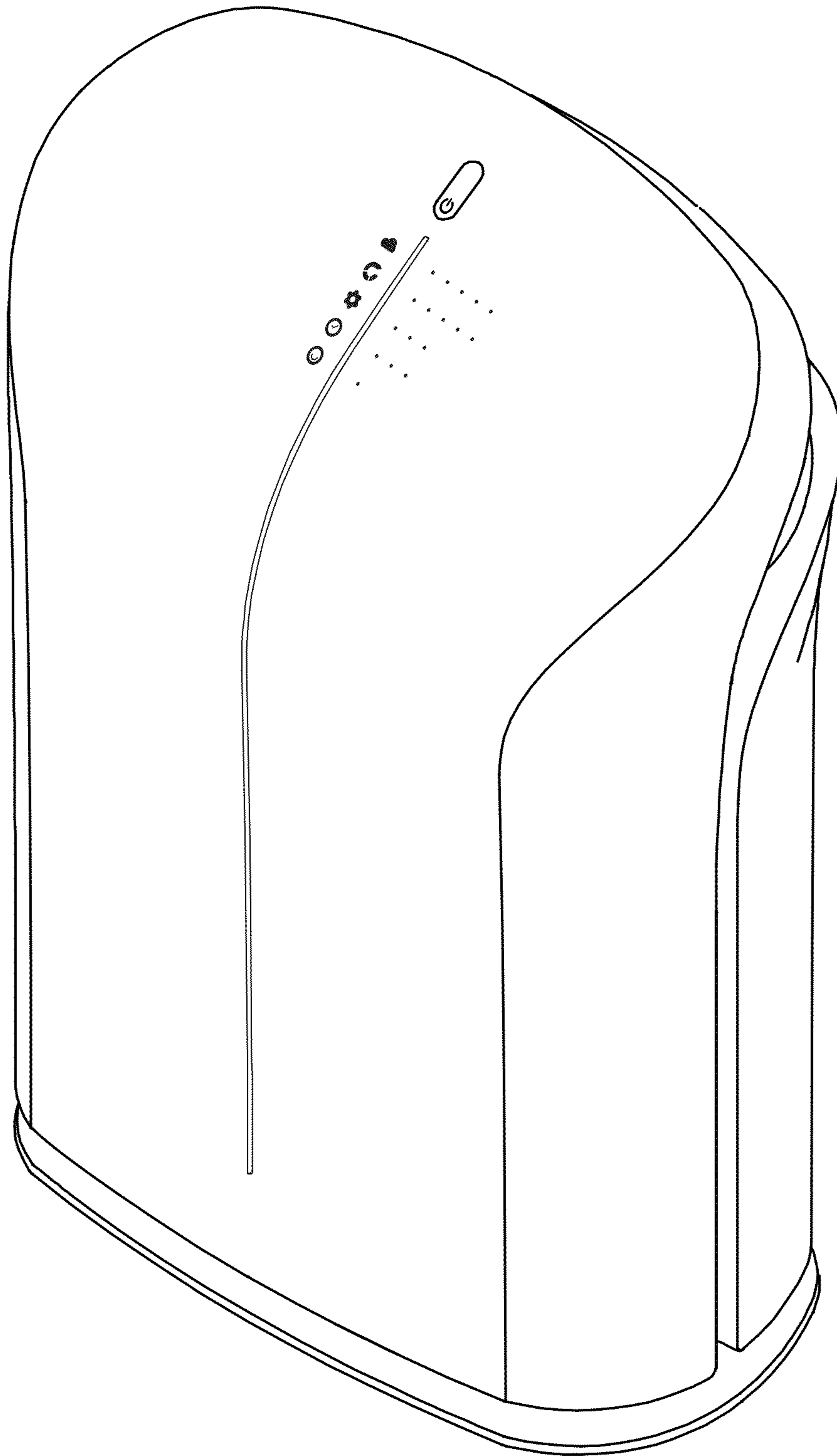

FIG. 10

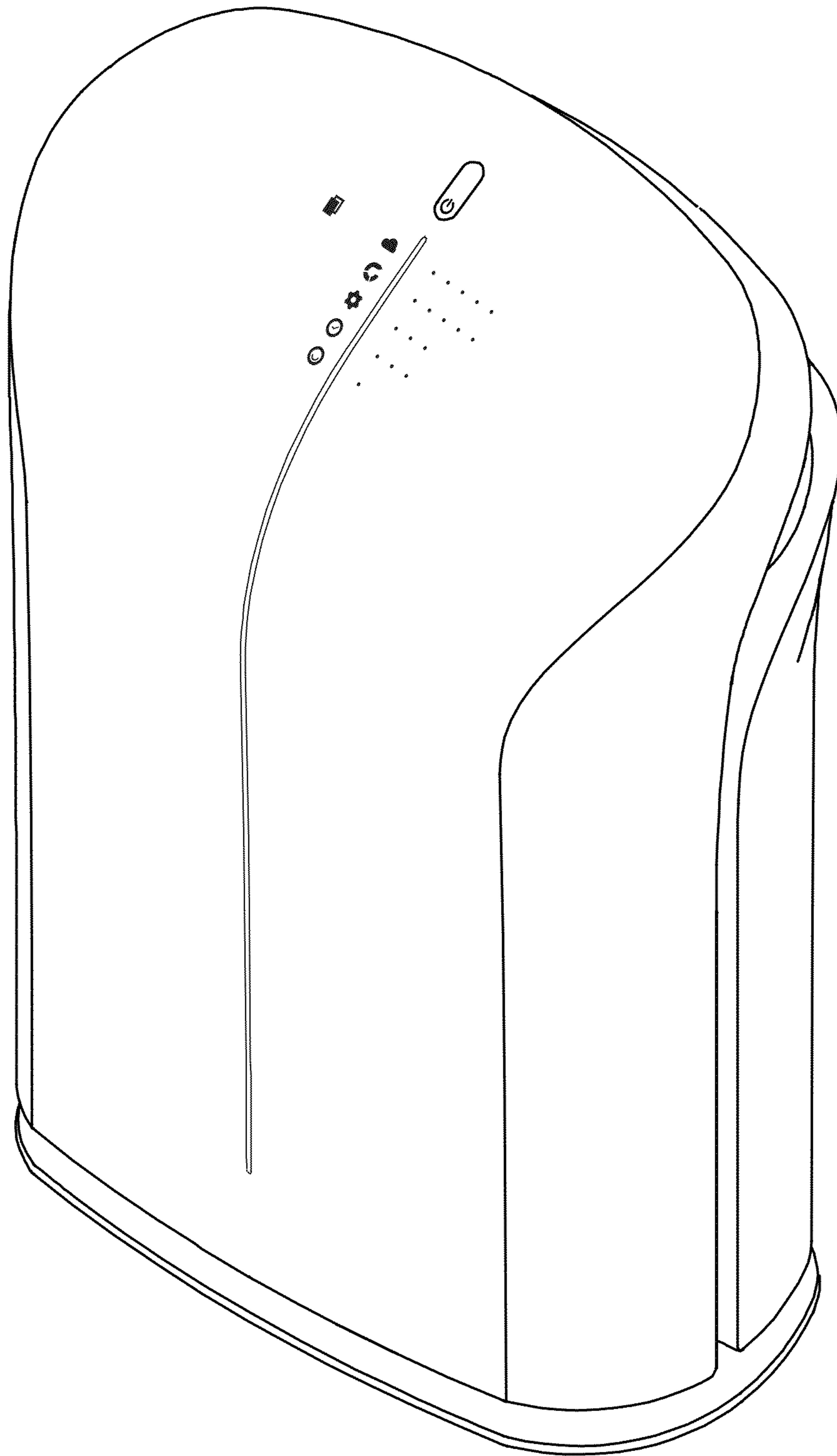

FIG. 11

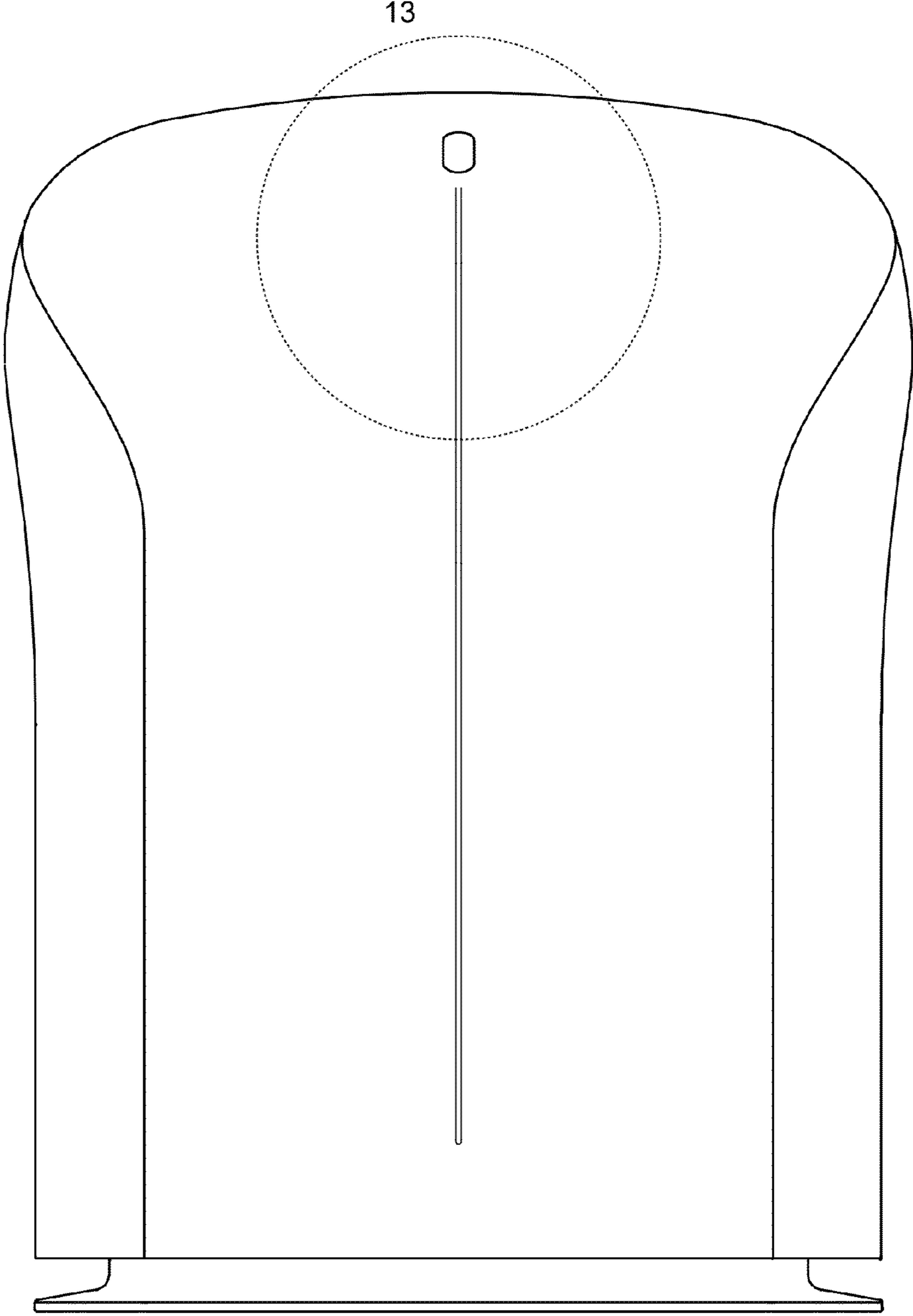

FIG. 12

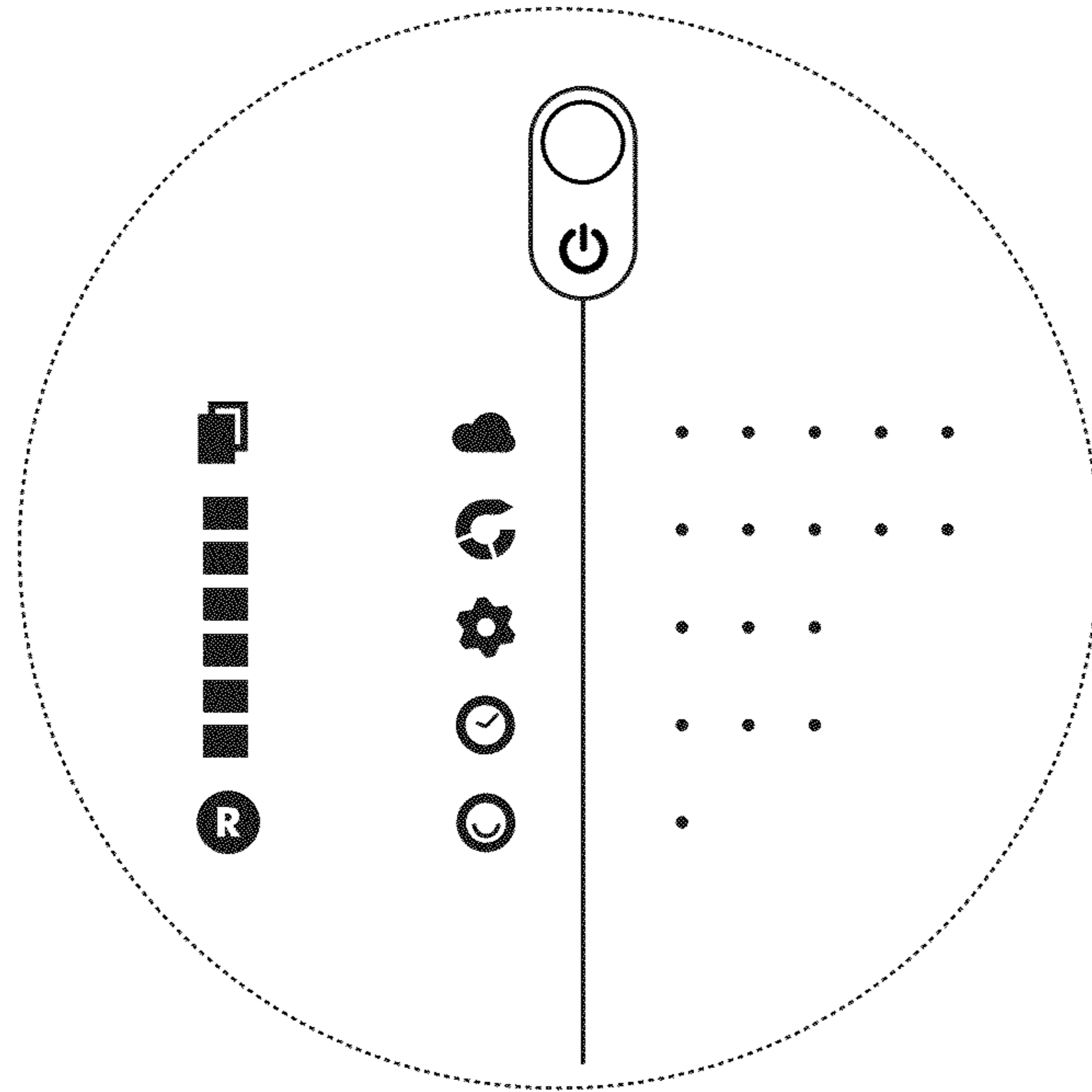

FIG. 13