



US00D745795S

(12) **United States Design Patent**
Luo

(10) **Patent No.:** **US D745,795 S**
(45) **Date of Patent:** **** *Dec. 22, 2015**

- (54) **GARMENT LOCKER**
- (71) Applicant: **Digilock Asia Ltd.**, Kowloon (HK)
- (72) Inventor: **Liu Luo**, ShenZhen (CN)
- (73) Assignee: **Digilock Asia Ltd.**, Kowloon (HK)

6,793,299	B2 *	9/2004	Newberry et al.	312/199
D509,081	S *	9/2005	Anderson et al.	D6/432
7,780,018	B1 *	8/2010	Sauder et al.	211/134
D672,574	S *	12/2012	Wilson, Jr.	D6/663
D710,636	S *	8/2014	Lim	D6/703
D711,673	S *	8/2014	Lim	D6/703
D718,933	S *	12/2014	Brown, Jr.	D3/255
D721,524	S *	1/2015	Theisen et al.	D6/671

(*) Notice: This patent is subject to a terminal disclaimer.

* cited by examiner

(**) Term: **14 Years**

Primary Examiner — Ricky Pham

(21) Appl. No.: **29/488,069**

(74) *Attorney, Agent, or Firm* — Thomas M. Freiburger

(22) Filed: **Apr. 15, 2014**

(57) **CLAIM**

The ornamental design for a garment locker, substantially as shown and described.

(30) **Foreign Application Priority Data**

DESCRIPTION

Mar. 12, 2014 (AU) 201411167

(51) **LOC (10) Cl.** **06-06**

(52) **U.S. Cl.**
USPC **D6/703**

(58) **Field of Classification Search**
USPC D3/255; D6/559, 661, 663, 664, 668, D6/668.1, 668.2, 671, 671.1–671.4, 703; 211/134; 312/114, 138.1, 199, 204, 312/213, 312, 220, 224, 257.1, 330.1
CPC A47B 57/10; A47B 96/00; A47B 47/03; A47B 47/042; A47B 53/00; A47B 53/02; A47B 61/00; A47B 61/003; A47B 61/02; A47B 67/00; A47B 67/02; A47B 67/04; A47B 67/005; A47B 88/22; A47B 3/00; A47B 3/0404; A47B 3/043; A47B 3/0434; A47B 3/005; E05B 65/025; E05B 65/0003
See application file for complete search history.

FIG. 1 is a perspective view of a first embodiment of a garment locker according to my new design, with the two locker doors shown closed and with portions of the locker shown in dashed lines not forming a part of my design;
FIG. 2 is a right frontal elevation view thereof, showing the two locker doors in opened position, and with portions of the locker shown in dashed lines not forming a part of my design;
FIG. 3 is a front elevation view thereof, with the locker doors closed; and
FIG. 4 is a front elevation view thereof, with the locker doors shown open.
FIG. 5 is a perspective view of a second embodiment of a garment locker according to my new design, with the two locker doors shown closed and with portions of the locker shown in dashed lines not forming a part of my design;
FIG. 6 is a right frontal elevation view thereof, showing the two locker doors in opened position, and with portions of the locker shown in dashed lines not forming a part of my design;
FIG. 7 is a front elevation view thereof, with the locker doors closed; and
FIG. 8 is a front elevation view thereof, with the locker doors shown open;
FIG. 9 is a perspective view of a third embodiment of a garment locker according to my new design, with the two locker doors shown closed and with portions of the locker shown in dashed lines not forming a part of my design;

(56) **References Cited**

U.S. PATENT DOCUMENTS

D262,844	S *	2/1982	Richardson	D6/432
5,310,254	A *	5/1994	Dallaire	312/213
D359,402	S *	6/1995	Tisbo et al.	D6/434
6,685,285	B1 *	2/2004	Fromme et al.	312/220
D492,508	S *	7/2004	Anderson et al.	D6/448

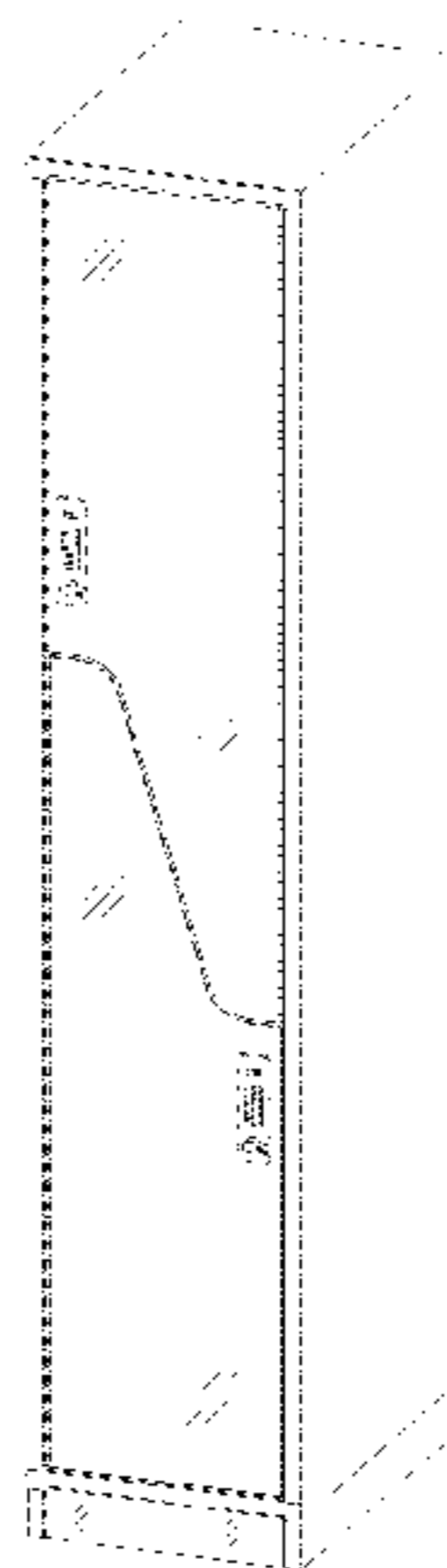

FIG. 10 is a right frontal elevation view thereof, showing the two locker doors in opened position, and with portions of the locker shown in dashed lines not forming a part of my design; FIG. 11 is a front elevation view thereof, with the locker doors closed; and

FIG. 12 is a front elevation view thereof, with the locker doors shown open;

FIG. 13 is a perspective view of a fourth embodiment of a garment locker according to my new design, with the two locker doors shown closed and with portions of the locker shown in dashed lines not forming a part of my design;

FIG. 14 is a right frontal elevation view thereof, showing the two locker doors in opened position, and with portions of the locker shown in dashed lines not forming a part of my design; FIG. 15 is a front elevation view thereof, with the locker doors closed; and,

FIG. 16 is a front elevation view thereof, with the locker doors shown open.

The exterior sides, rear, top and bottom of the garment locker, shown in broken lines, do not form a part of my design.

1 Claim, 8 Drawing Sheets

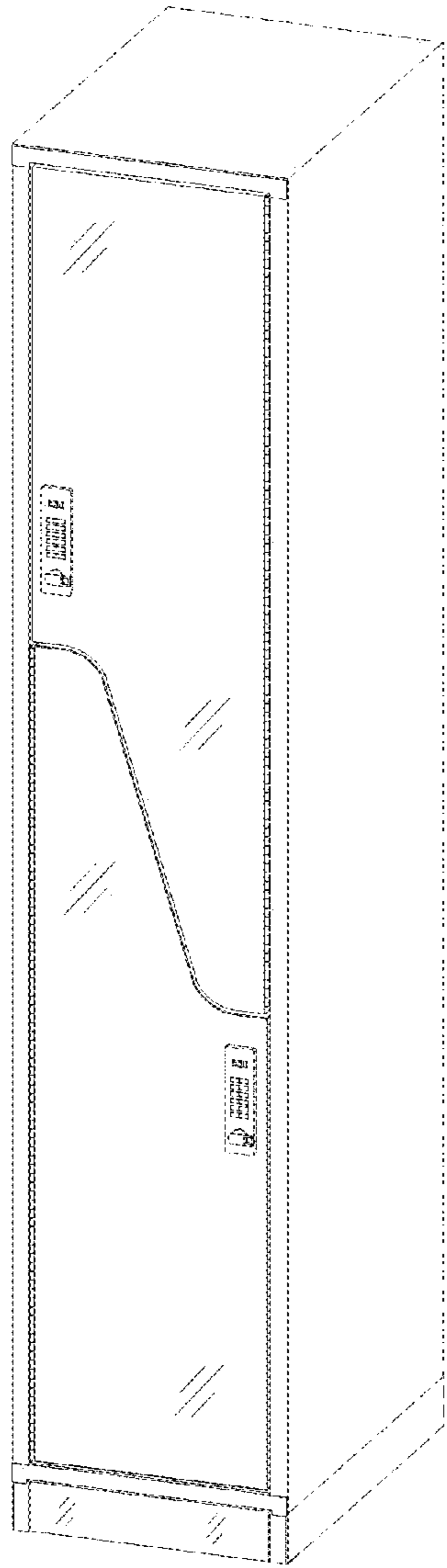

FIG 1

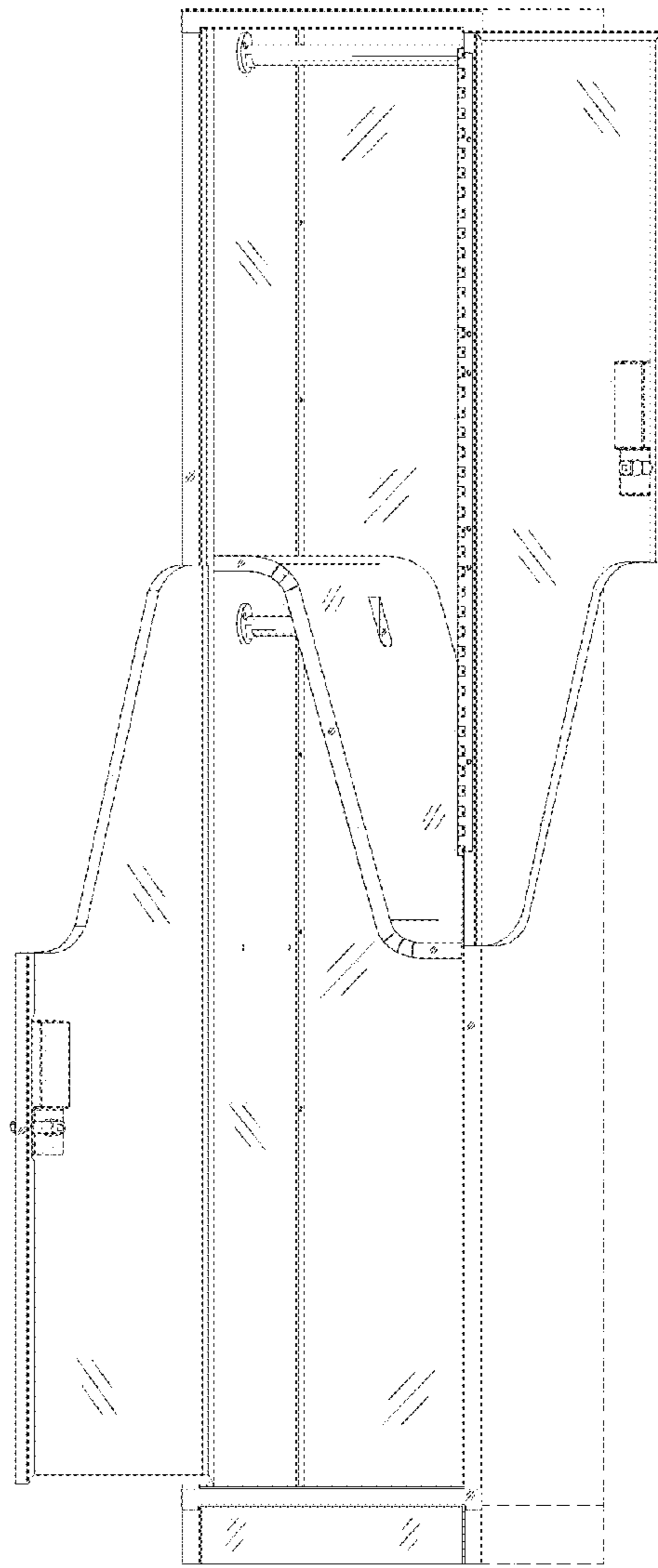

FIG 2

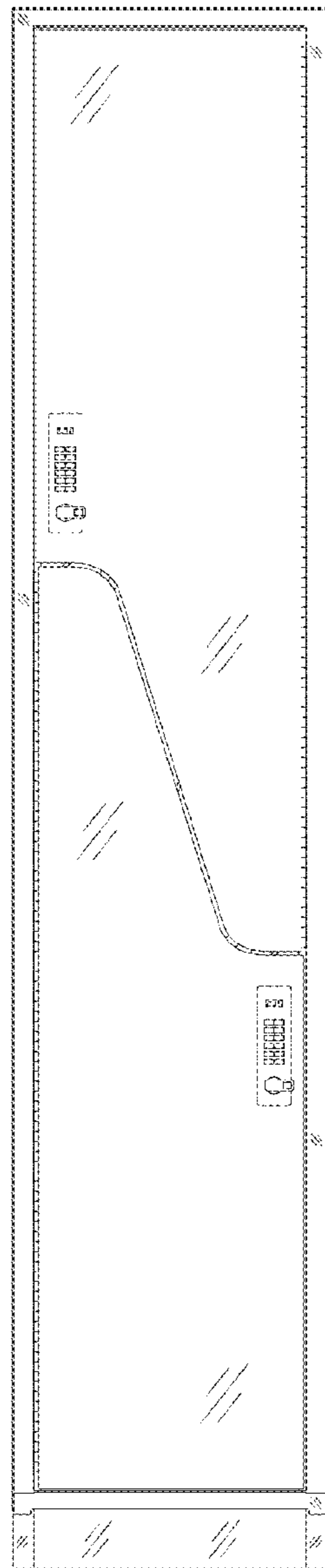

FIG 3

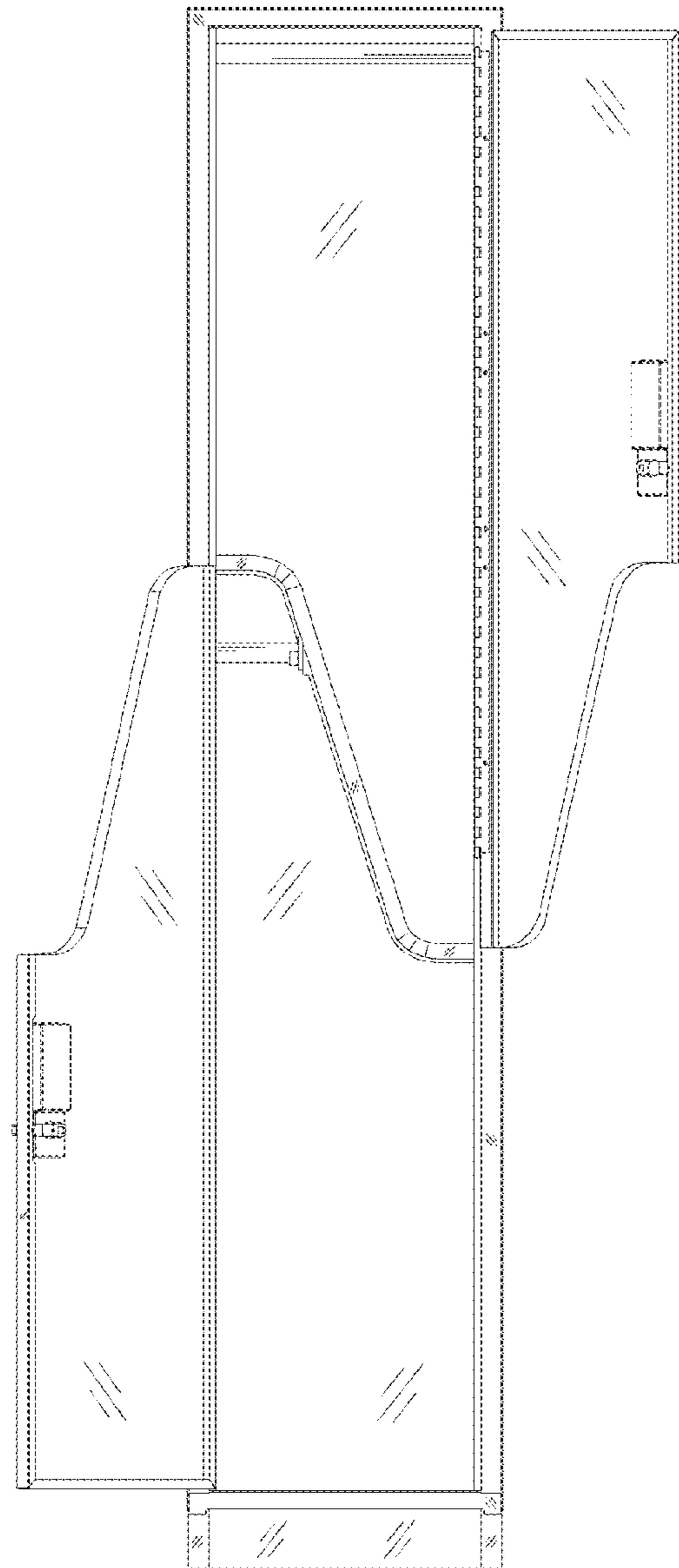

FIG 4

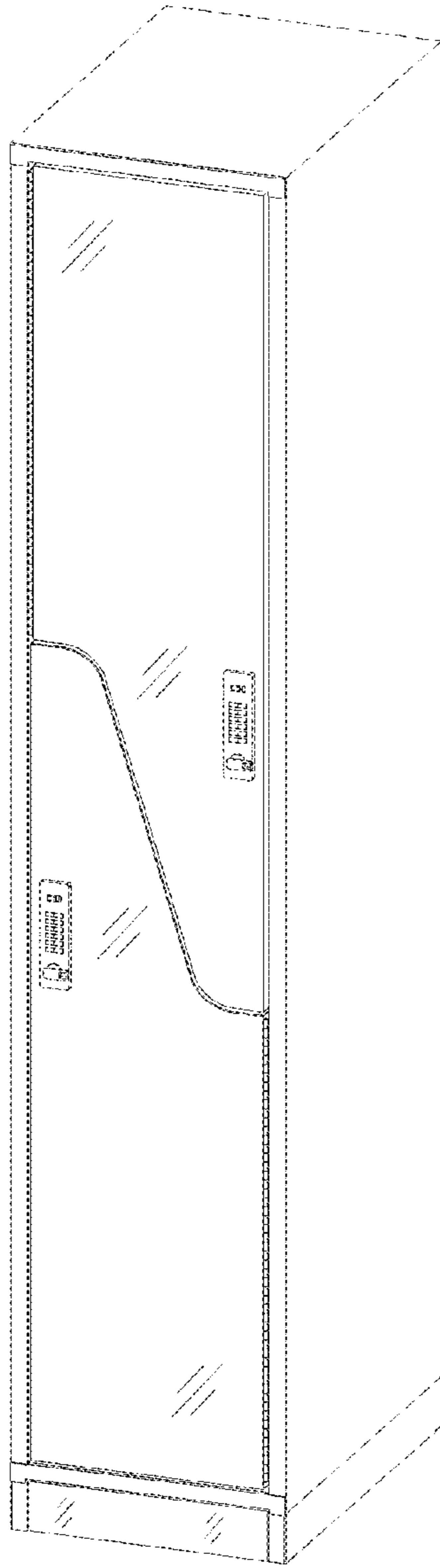

FIG 5

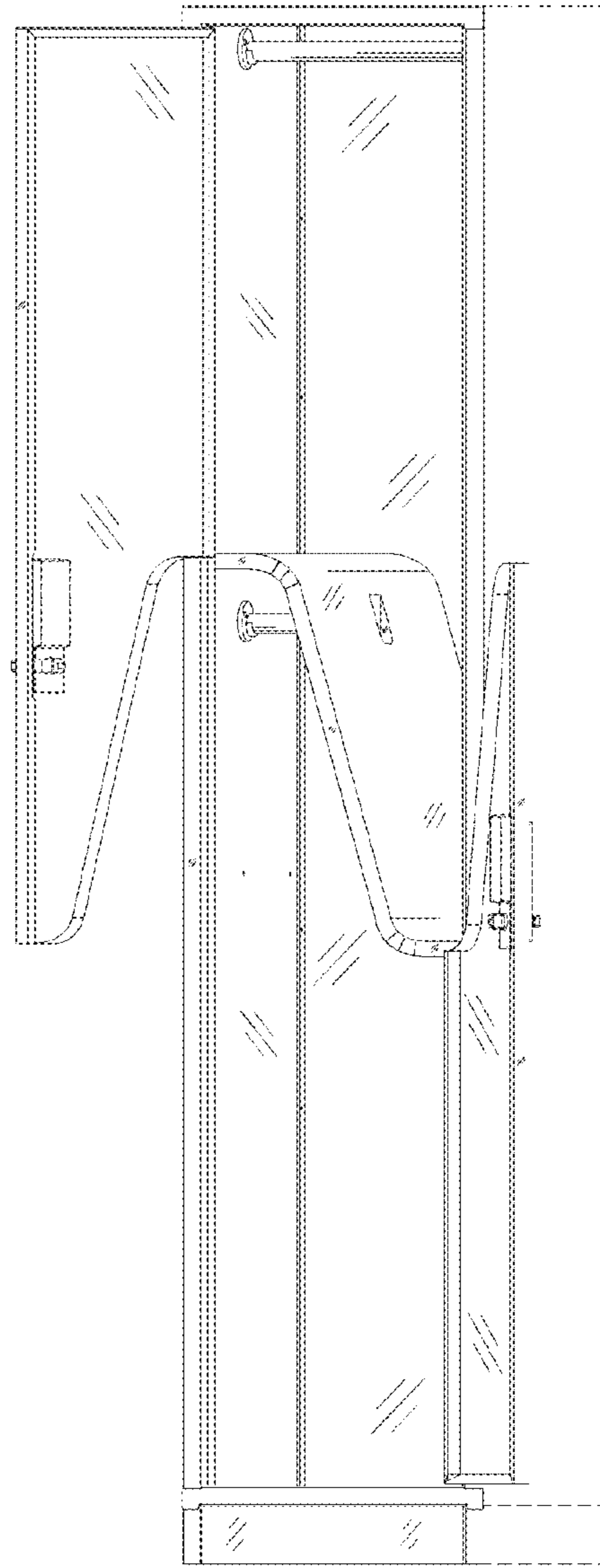

FIG 6

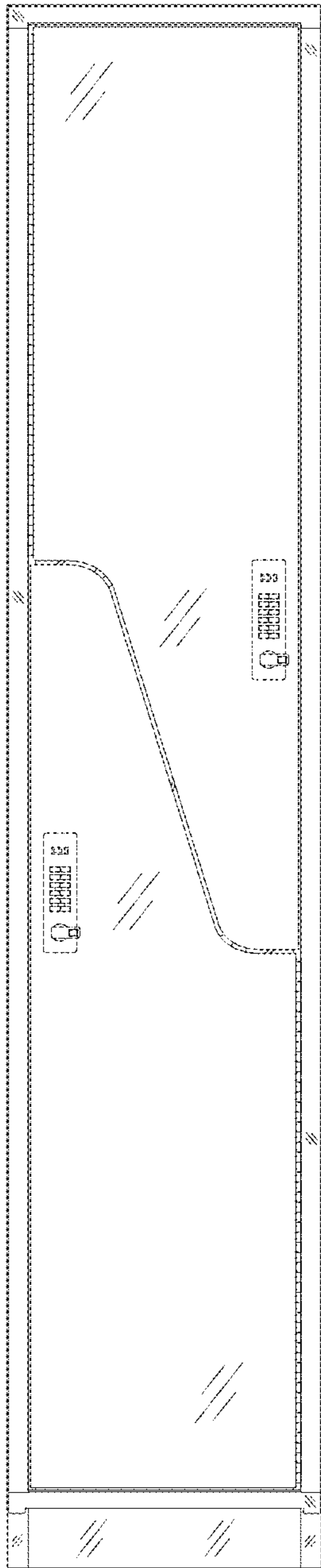

FIG 7

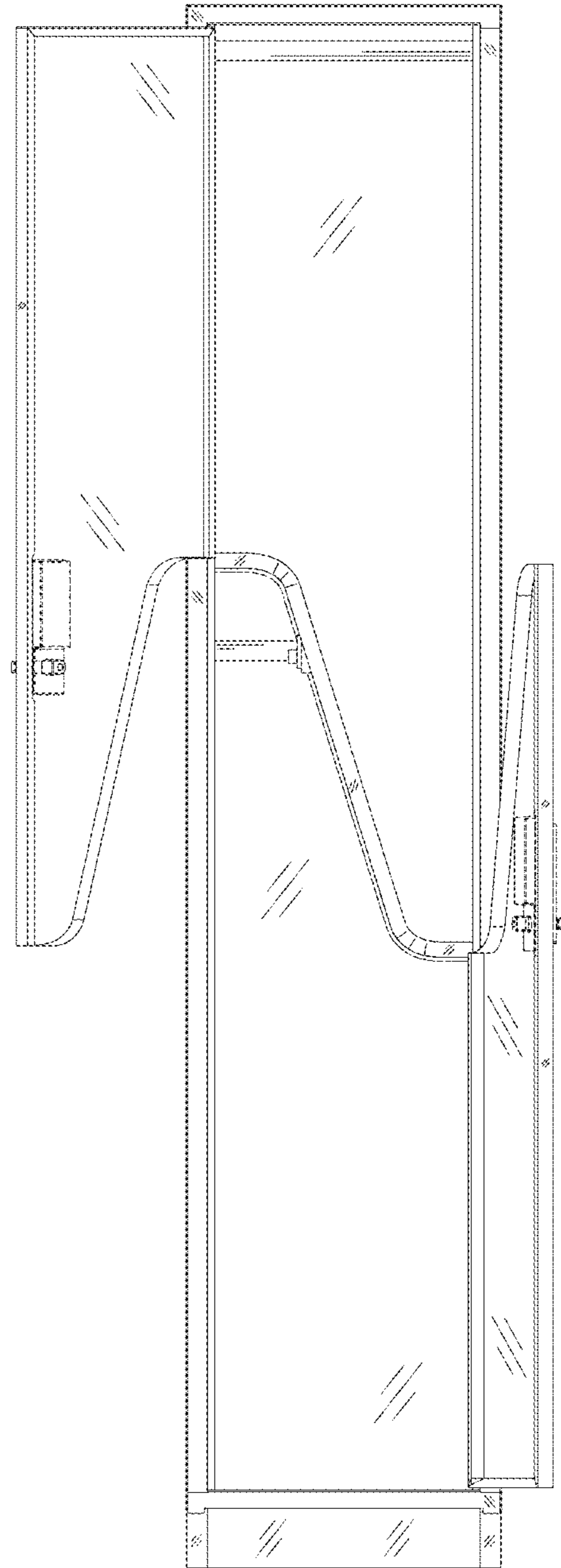

FIG 8

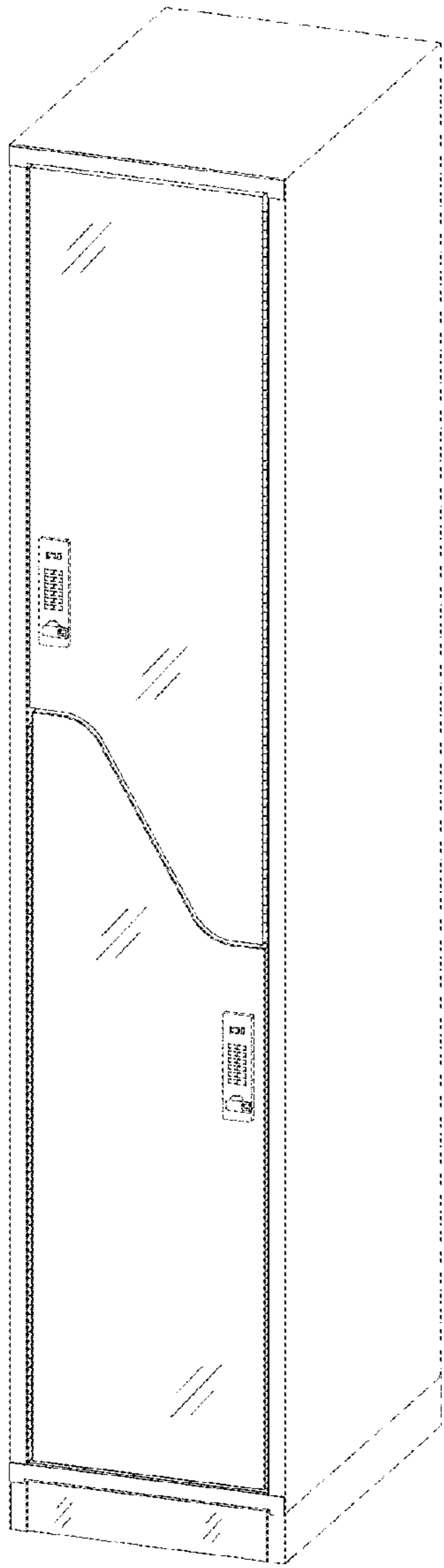

FIG 9

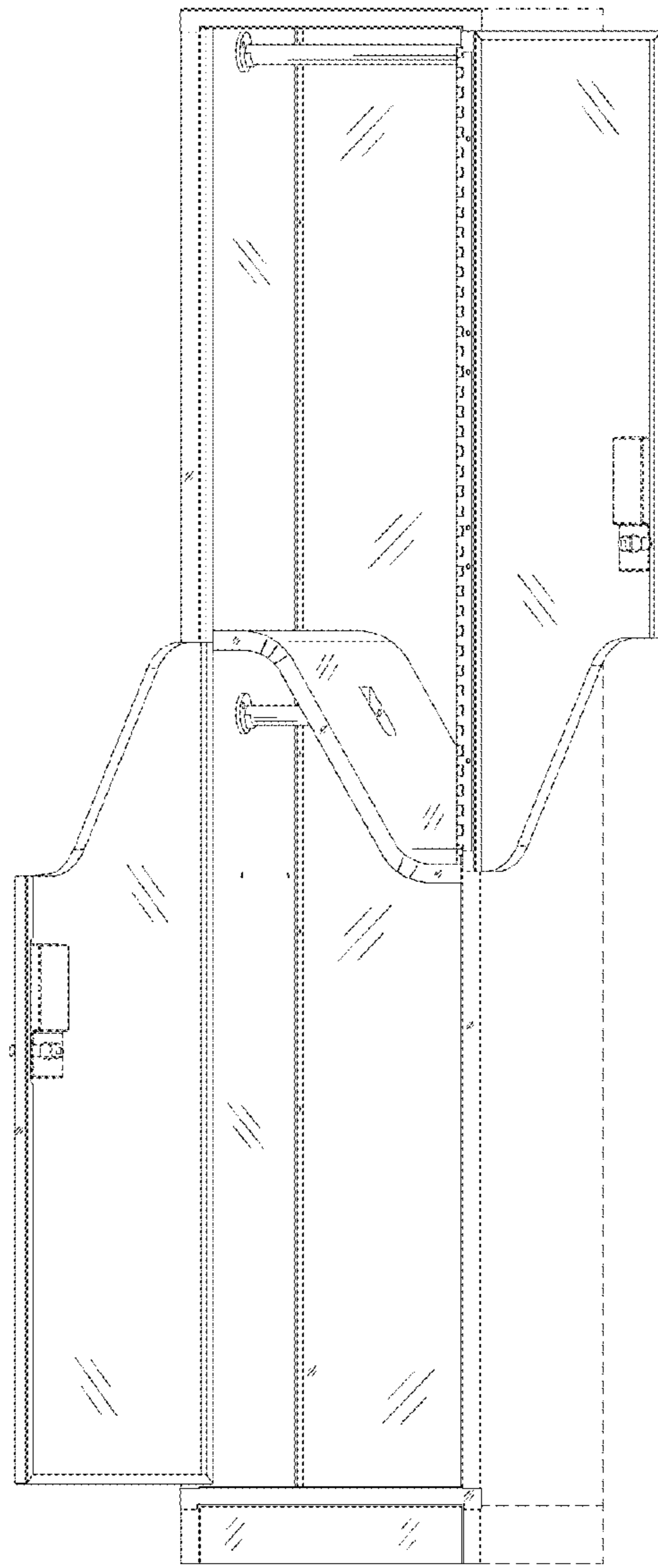

FIG 10

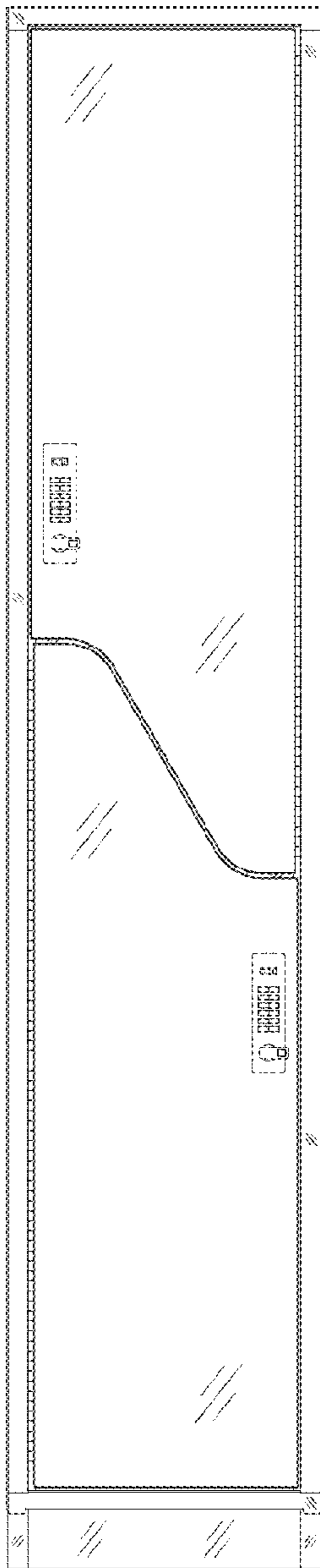

FIG 11

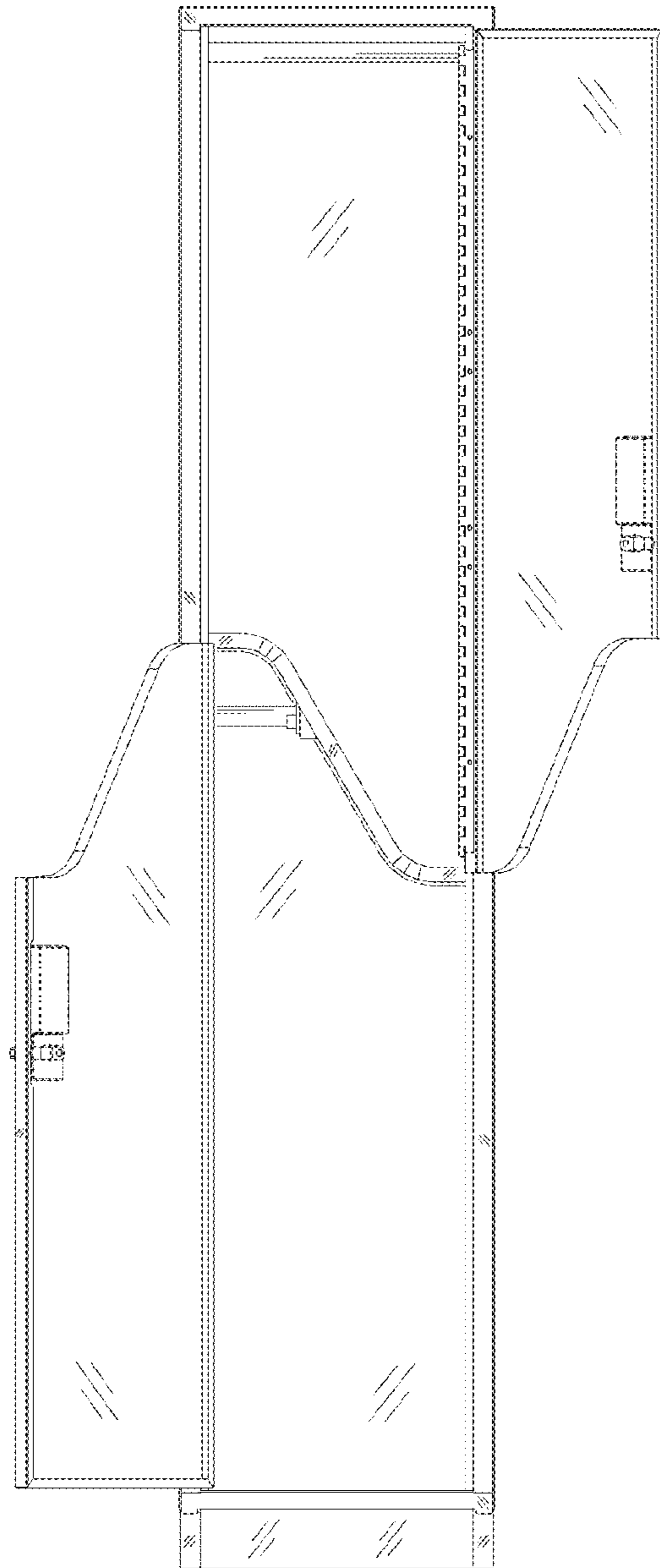

FIG 12

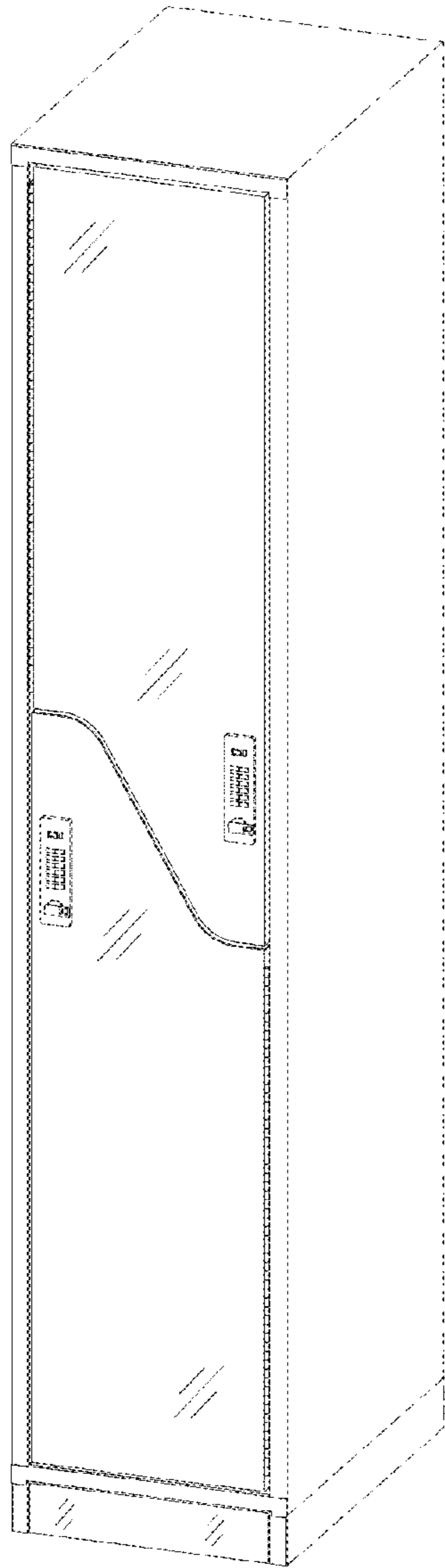

FIG 13

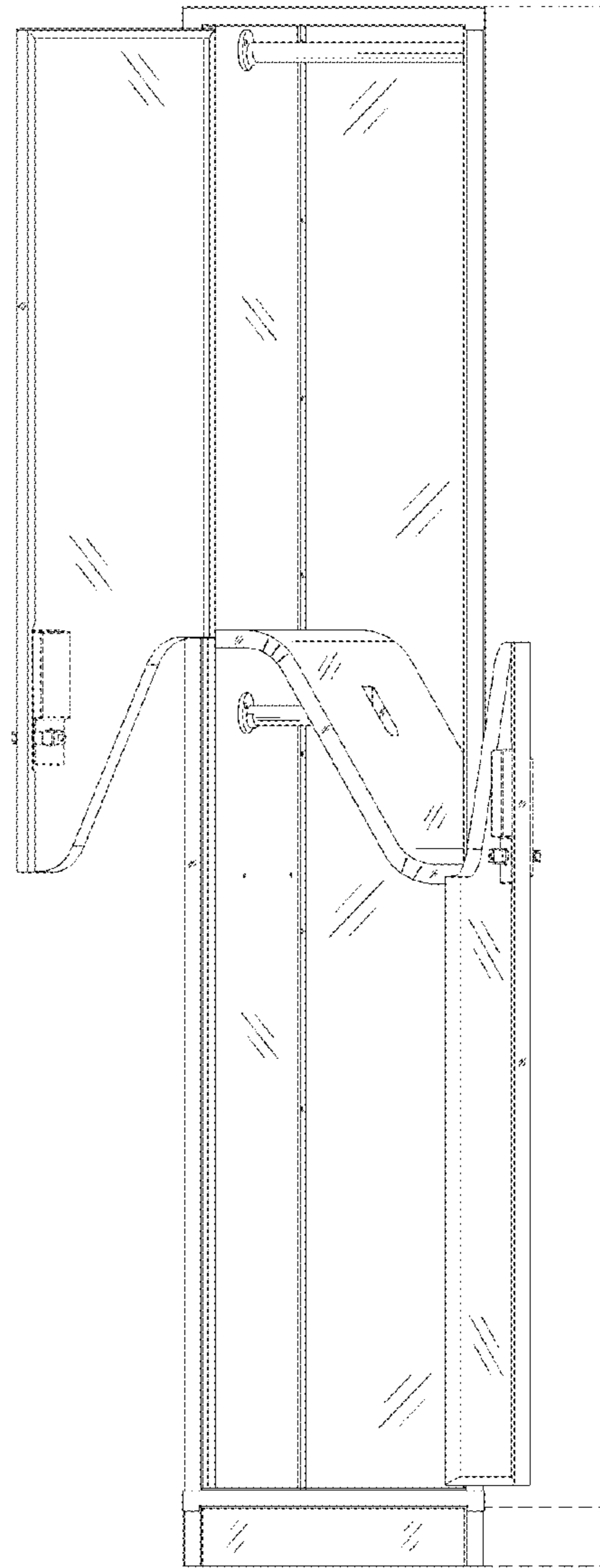

FIG 14

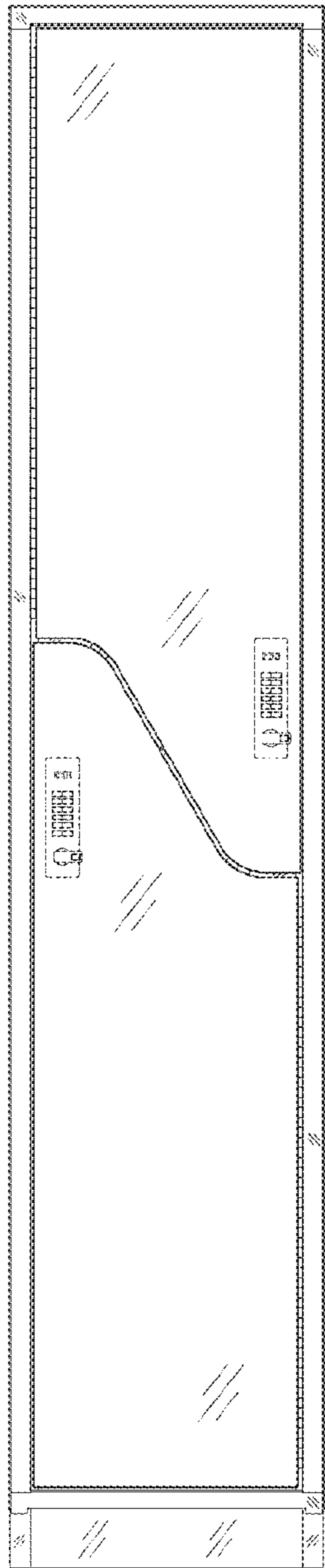

FIG 15

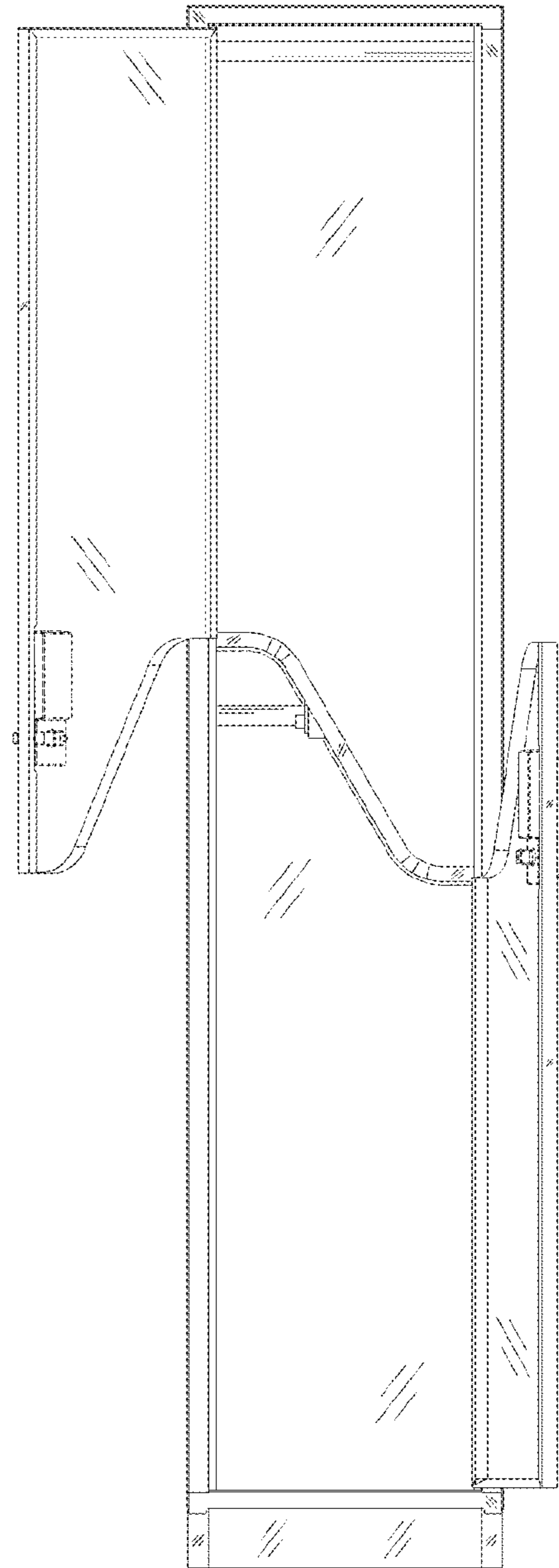

FIG 16