



US00D745782S

(12) **United States Design Patent**  
**Booth**

(10) **Patent No.:** **US D745,782 S**  
(45) **Date of Patent:** **\*\* Dec. 22, 2015**

(54) **TOOTHBRUSH**

(75) Inventor: **Christopher Edgerley Booth**, Ashton (GB)

(73) Assignee: **Intersurgical AG**, Baduz (LI)

(\*\*) Term: **14 Years**

(21) Appl. No.: **29/409,497**

(22) Filed: **Dec. 23, 2011**

(30) **Foreign Application Priority Data**

Jun. 24, 2011 (EP) ..... 001882812

(51) **LOC (10) Cl.** ..... **04-02**

(52) **U.S. Cl.**  
USPC ..... **D4/108; D4/114**

(58) **Field of Classification Search**  
USPC ..... 15/167.1, 167.2; 132/308-311; D4/101, D4/104-112, 114, 115, 138; D24/111; 401/270, 272, 276, 279, 282, 286, 288, 401/289, 291; 433/80, 82, 89-92, 95, 216; 601/162, 165

CPC .... A46B 11/00; A46B 11/001; A46B 11/006; A46B 11/06; A46B 11/063; A46B 11/066; A46B 2200/1066

See application file for complete search history.

(56) **References Cited**

**U.S. PATENT DOCUMENTS**

D149,620	S *	5/1948	Darr	.....	D4/101
3,273,189	A *	9/1966	Levinson et al.	.....	15/22.1
D274,575	S *	7/1984	Kronner	.....	D4/100
D282,319	S *	1/1986	Herzfeld	.....	D4/115
D513,881	S *	1/2006	Meyers et al.	.....	D4/102
7,776,004	B2 *	8/2010	Yarger	.....	604/35
D660,599	S	5/2012	Hohlbein		
8,444,340	B2 *	5/2013	Best	.....	401/289
D735,998	S	8/2015	Booth		
2006/0167391	A1 *	7/2006	Ohayon	.....	601/165
2013/0052610	A1 *	2/2013	Dombrowski et al.	.....	433/95

**FOREIGN PATENT DOCUMENTS**

CN 202396799 U \* 8/2012 ..... A46B 15/00  
EP 0 993 790 A2 4/2000

**OTHER PUBLICATIONS**

StarMed Medical Disposables, "Oral-Clean, Dispositivo Monouso Per L'igiene Orale, Oral Care Disposable Device," 2 pages (2003).  
Trademark Medical, "Dental Products: Suction Toothbrush," retrieved from <http://www.trademarkmedical.com/pro/pro-dental-plakvac.html>, 2 pages (2010).

\* cited by examiner

*Primary Examiner* — Melanie H Tung  
*Assistant Examiner* — Lavone D Tabor

(74) *Attorney, Agent, or Firm* — LeClairRyan, a Professional Corporation

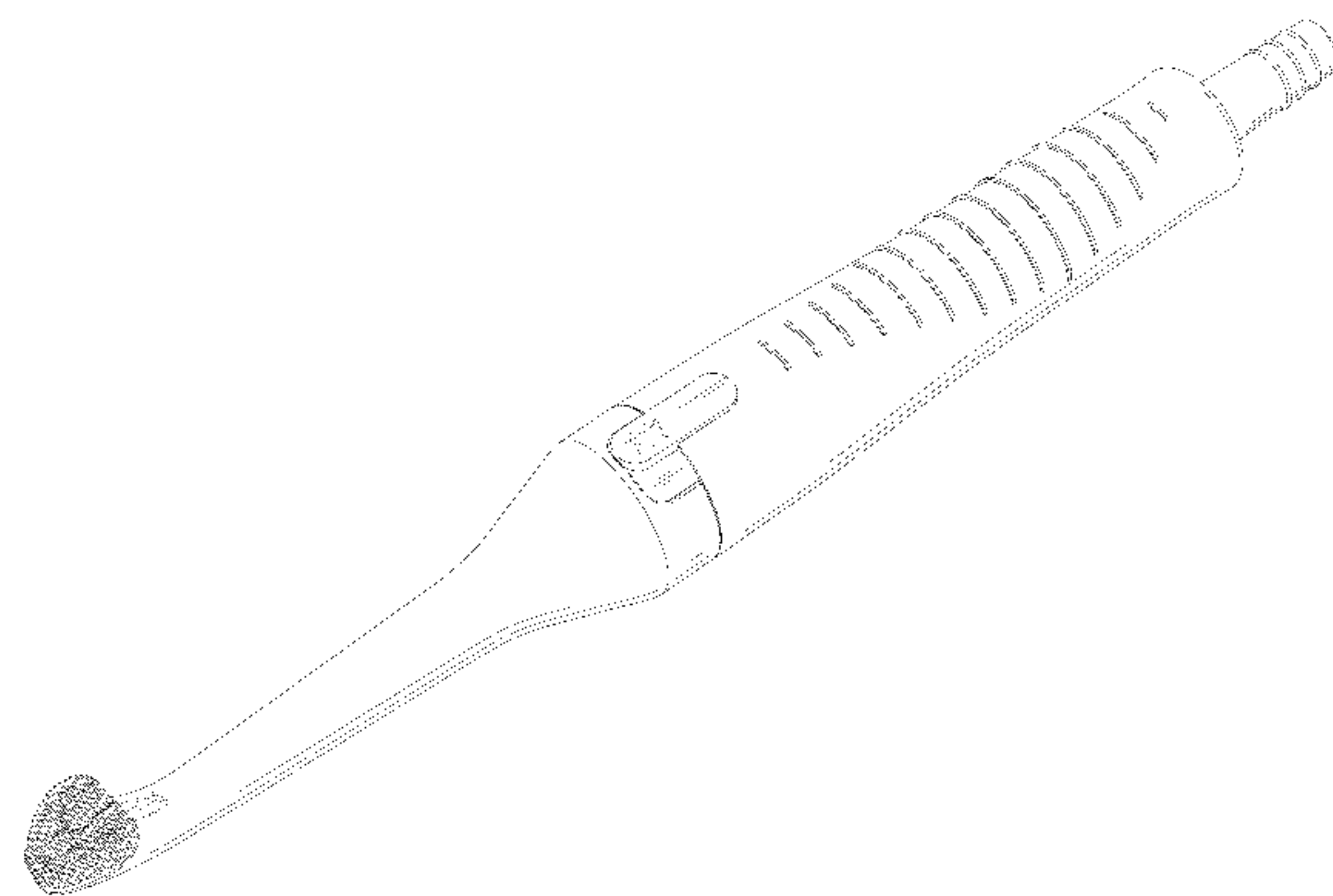
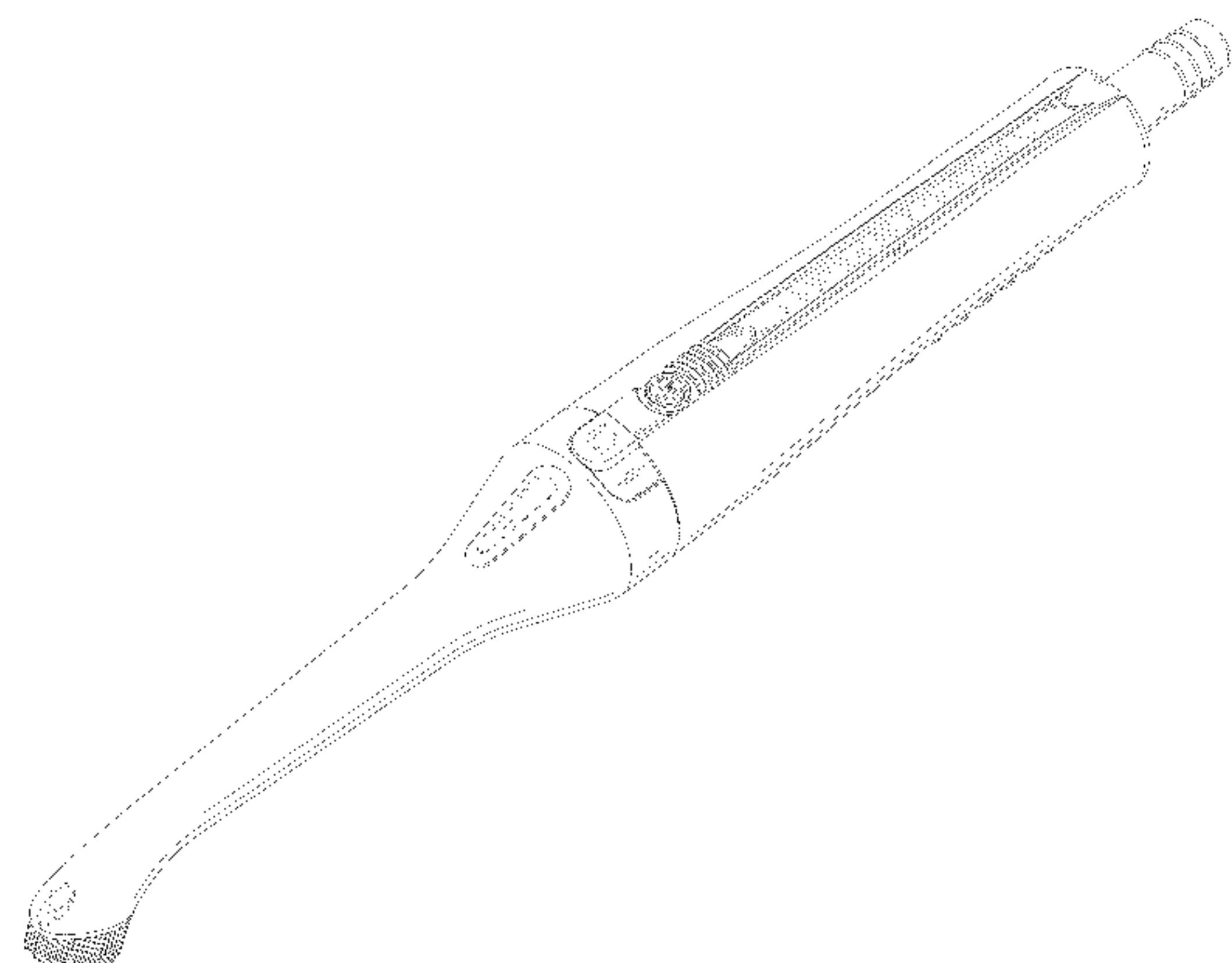
(57) **CLAIM**

The ornamental design for a toothbrush, as shown and described.

**DESCRIPTION**

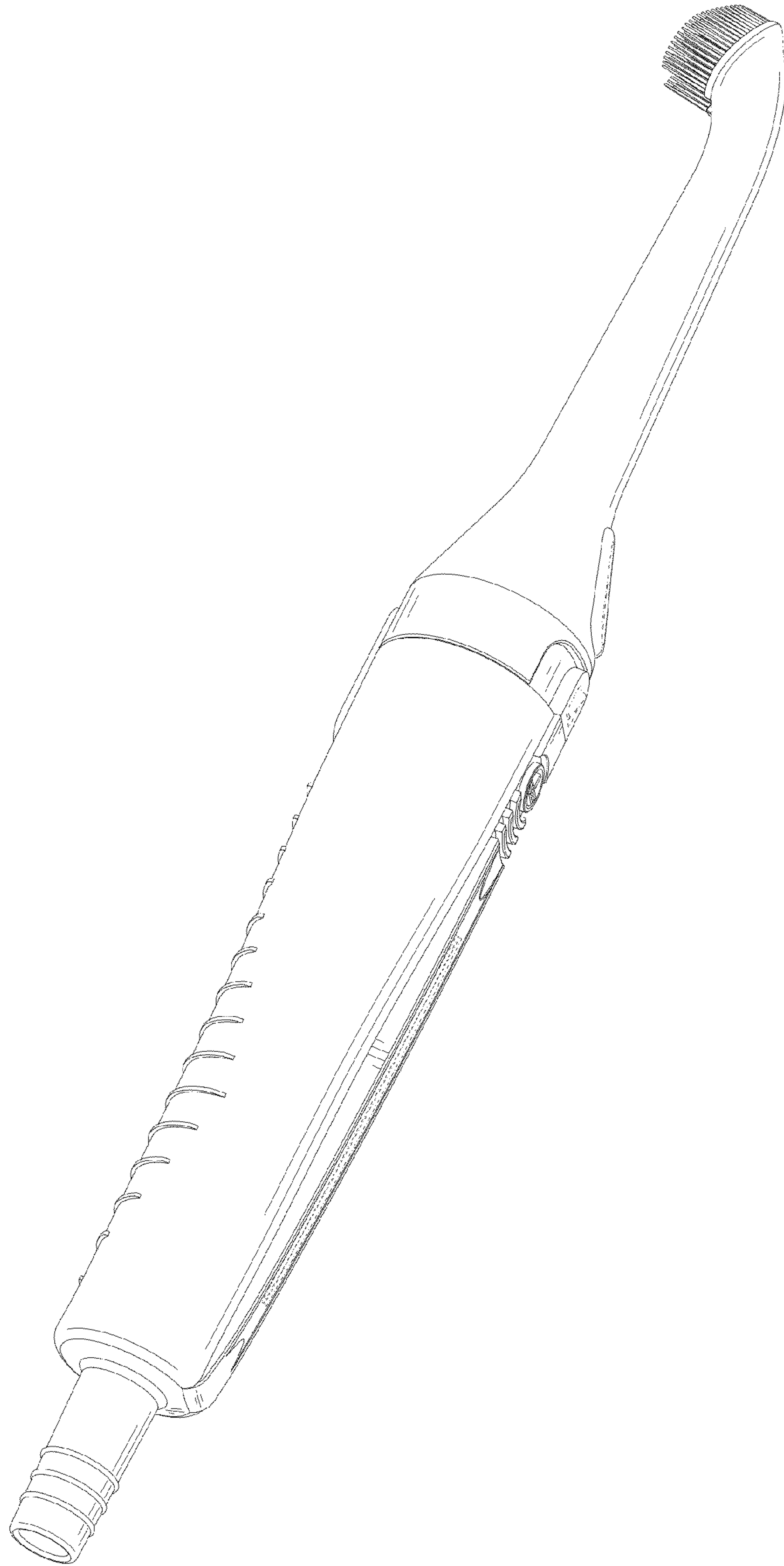
FIG. 1 is a top right perspective view of a toothbrush.  
FIG. 2 is a left side perspective view of the toothbrush shown in FIG. 1.  
FIG. 3 is a top perspective view of the toothbrush shown in FIG. 1.  
FIG. 4 is a bottom perspective view of the toothbrush shown in FIG. 1.  
FIG. 5 is a front end view of the toothbrush shown in FIG. 1.  
FIG. 6 is a bottom plan view of the toothbrush shown in FIG. 1.  
FIG. 7 is a top plan view of the toothbrush shown in FIG. 1.  
FIG. 8 is a left side elevational view of the toothbrush shown in FIG. 1; and,  
FIG. 9 is a rear end view of the toothbrush shown in FIG. 1.  
The broken lines in the drawings are for illustrative purposes only and form no part of the claimed design.

**1 Claim, 6 Drawing Sheets**

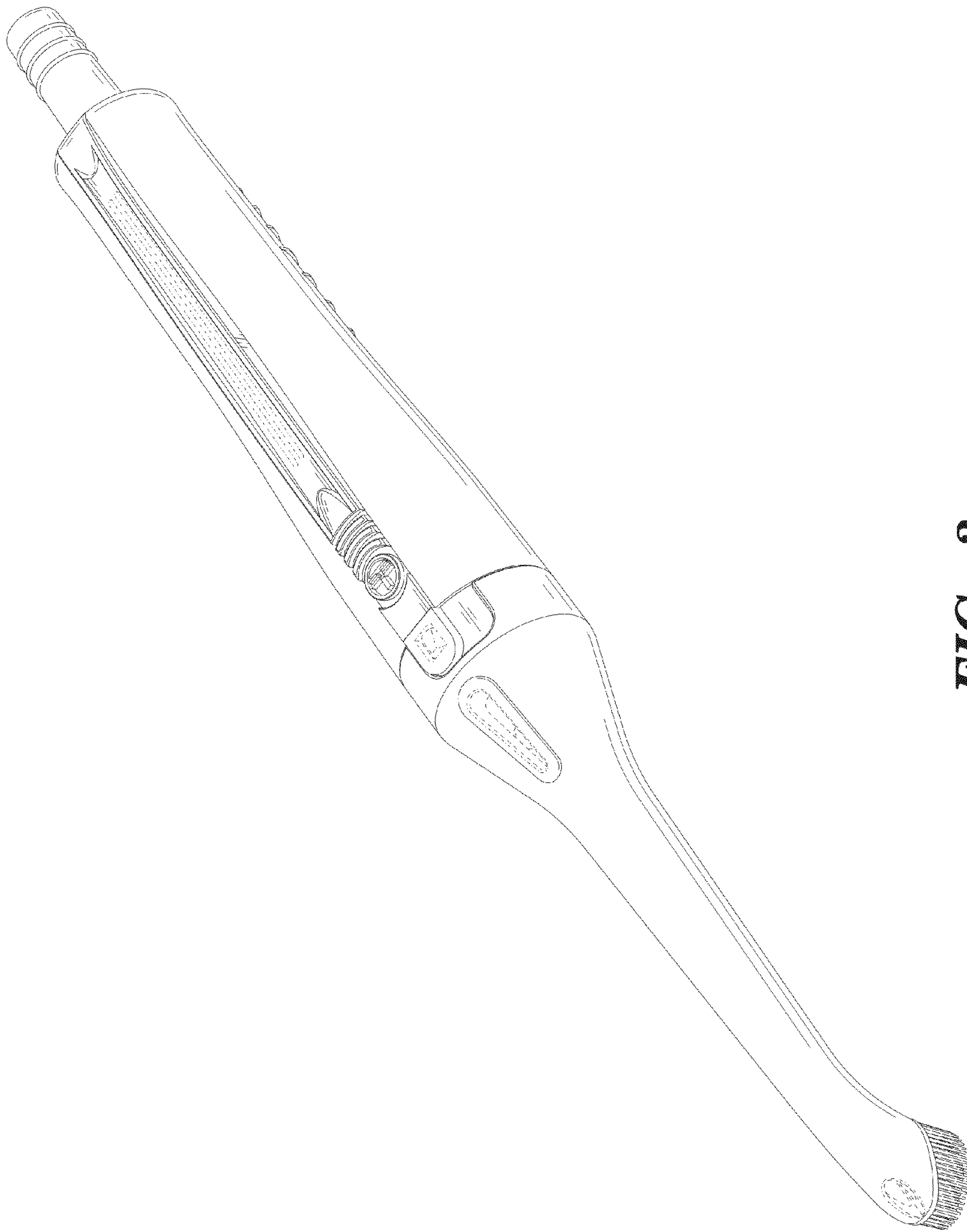




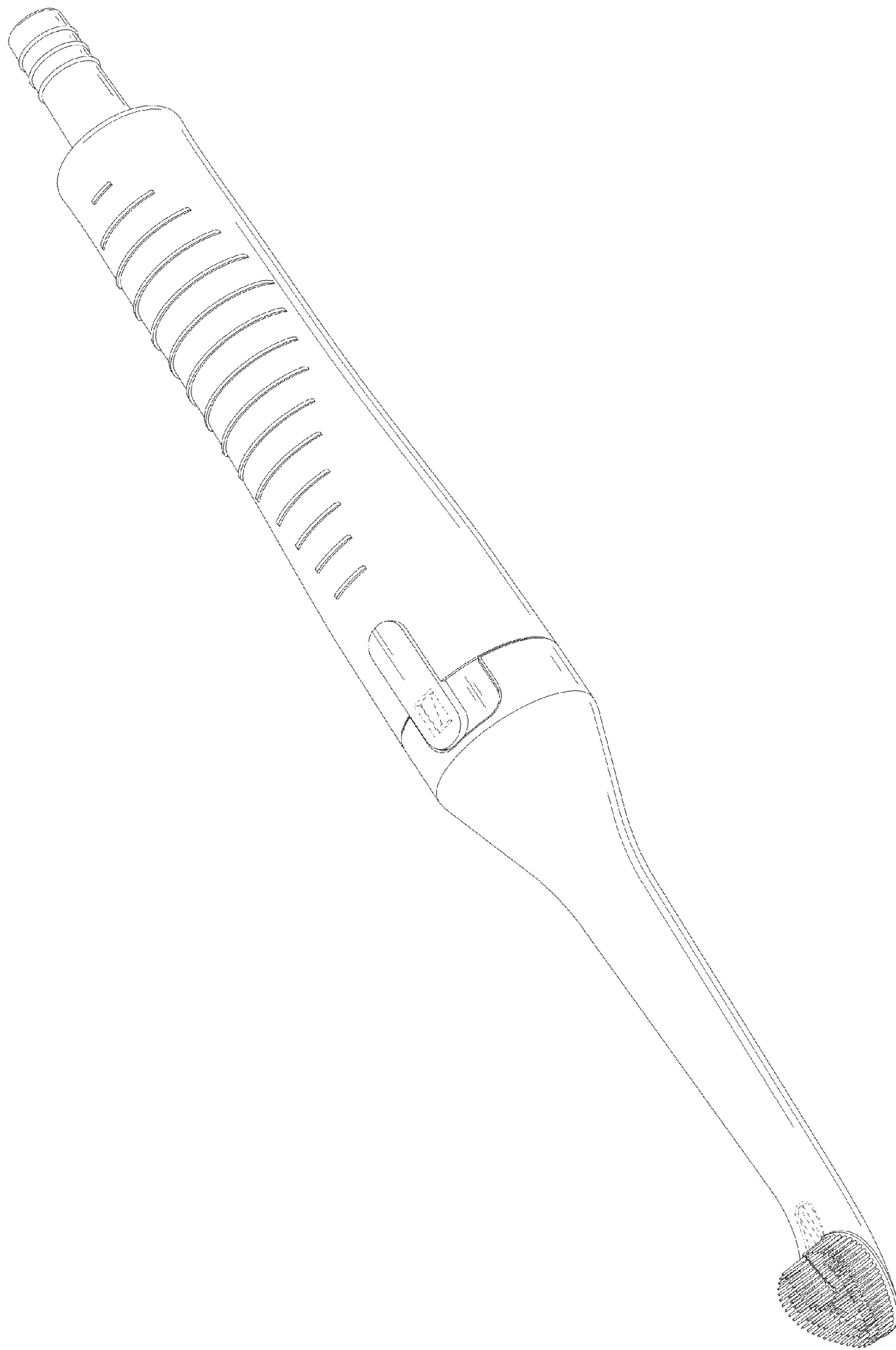
**FIG. 1**



**FIG. 2**

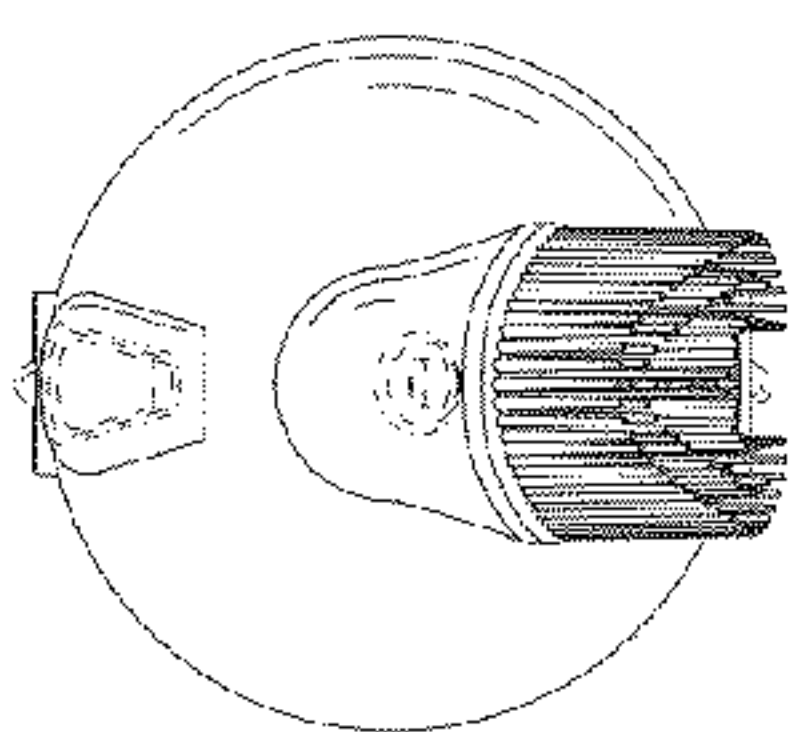


**FIG. 3**

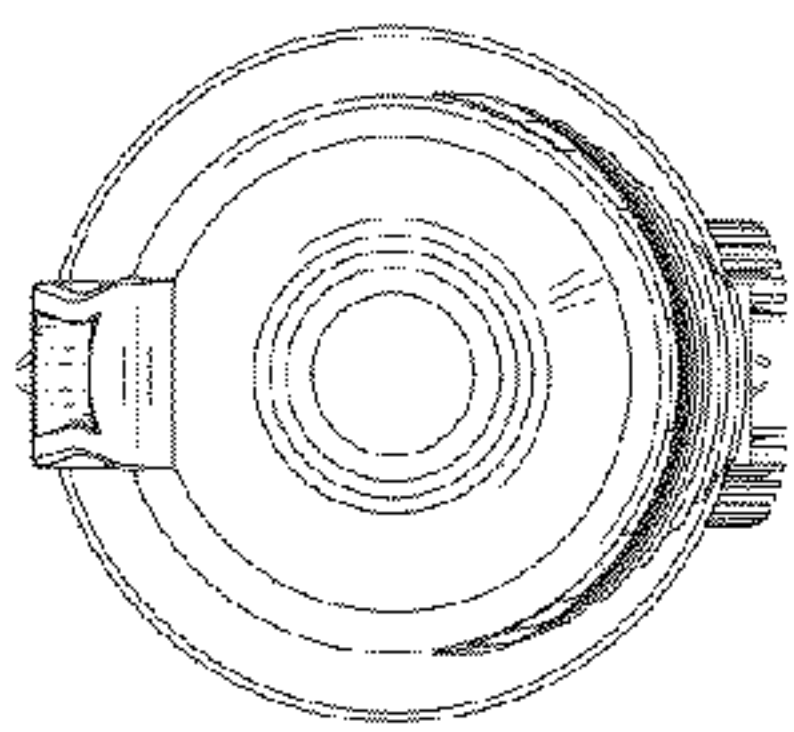


**FIG. 4**

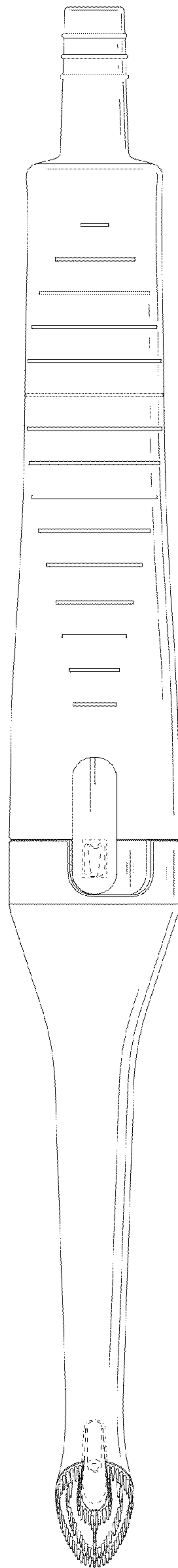




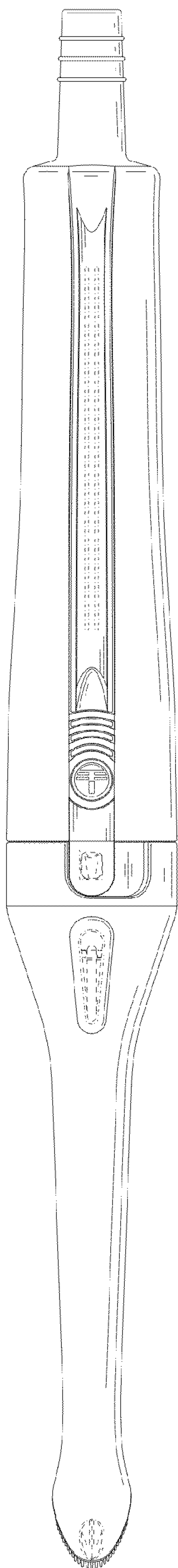
**FIG. 5**



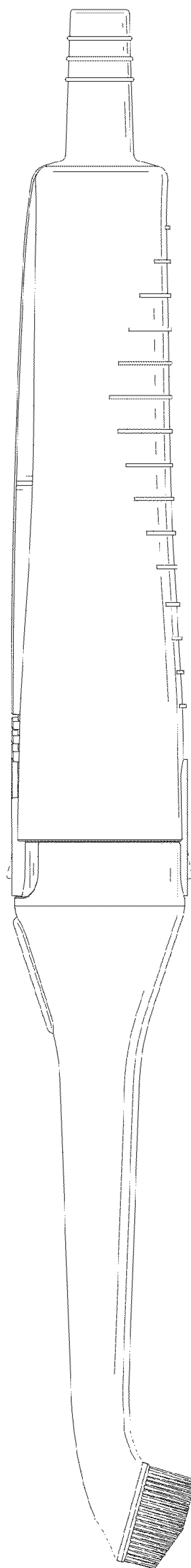
**FIG. 9**



**FIG. 6**



**FIG. 7**



**FIG. 8**

UNITED STATES PATENT AND TRADEMARK OFFICE  
**CERTIFICATE OF CORRECTION**

PATENT NO. : D745,782 S  
APPLICATION NO. : 29/409497  
DATED : December 22, 2015  
INVENTOR(S) : Christopher Edgerley Booth

Page 1 of 1

It is certified that error appears in the above-identified patent and that said Letters Patent is hereby corrected as shown below:

On the Title page at item (73) Assignee, delete "Baduz" and insert in its place --Vaduz--.

Signed and Sealed this  
Twenty-fourth Day of May, 2016



Michelle K. Lee  
*Director of the United States Patent and Trademark Office*