



US00D745692S

(12) **United States Design Patent**
Oh et al.

(10) **Patent No.:** **US D745,692 S**
(45) **Date of Patent:** **** Dec. 15, 2015**

- (54) **SAUNA APPARATUS FOR HALF-BATH**
- (71) Applicant: **NEWGENSAUNA CO., LTD.**, Daejeon (KR)
- (72) Inventors: **Sejung Oh**, Siheung (KR); **Minsouk Kim**, Seoul (KR)
- (73) Assignee: **NEWGENSAUNA CO., LTD.**, Daejeon (KR)
- (**) Term: **14 Years**
- (21) Appl. No.: **29/467,045**
- (22) Filed: **Sep. 13, 2013**
- (51) **LOC (10) Cl.** **23-02**
- (52) **U.S. Cl.**
USPC **D24/203**
- (58) **Field of Classification Search**
USPC D24/201–205; 4/524, 526, 528, 531, 4/532
See application file for complete search history.

6,965,097 B2 *	11/2005	Lee	219/492
D548,848 S *	8/2007	Schwarzenberger	
		et al.	D24/203
7,458,111 B2 *	12/2008	Sappenfield et al.	4/524
7,784,118 B2 *	8/2010	Lee	4/531
7,784,120 B2 *	8/2010	Spicer	4/592
D663,855 S *	7/2012	Zack et al.	D24/203

* cited by examiner

Primary Examiner — David Muller
(74) *Attorney, Agent, or Firm* — Drinker Biddle & Reath LLP

(57) **CLAIM**

The ornamental design for a sauna apparatus for half-bath, as shown and described.

DESCRIPTION

FIG. 1 is a bottom view of a sauna apparatus for half-bath showing our new design;
 FIG. 2 is a front view of the sauna apparatus for half-bath;
 FIG. 3 is a left side view of the sauna apparatus for half-bath;
 FIG. 4 is a perspective view of the sauna apparatus for half-bath;
 FIG. 5 is a rear view of the sauna apparatus for half-bath;
 FIG. 6 is a perspective view of the sauna apparatus for half-bath, with the door open;
 FIG. 7 is a right side view of the sauna apparatus for half-bath; and,
 FIG. 8 is a top view of the sauna apparatus for half-bath.
 The broken lines illustrated in the drawing views are included to show unclaimed environment only and form no part of the claimed design.

1 Claim, 8 Drawing Sheets

(56) **References Cited**

U.S. PATENT DOCUMENTS

D255,267 S *	6/1980	Sinaiko	D24/205
D257,490 S *	11/1980	Davis	D24/202
D271,523 S *	11/1983	Richburg	D24/204
5,117,481 A *	5/1992	Sung	392/416
D341,425 S *	11/1993	Lee	D24/203
5,446,929 A *	9/1995	Sills et al.	4/555
D455,497 S *	4/2002	Jensen et al.	D24/203

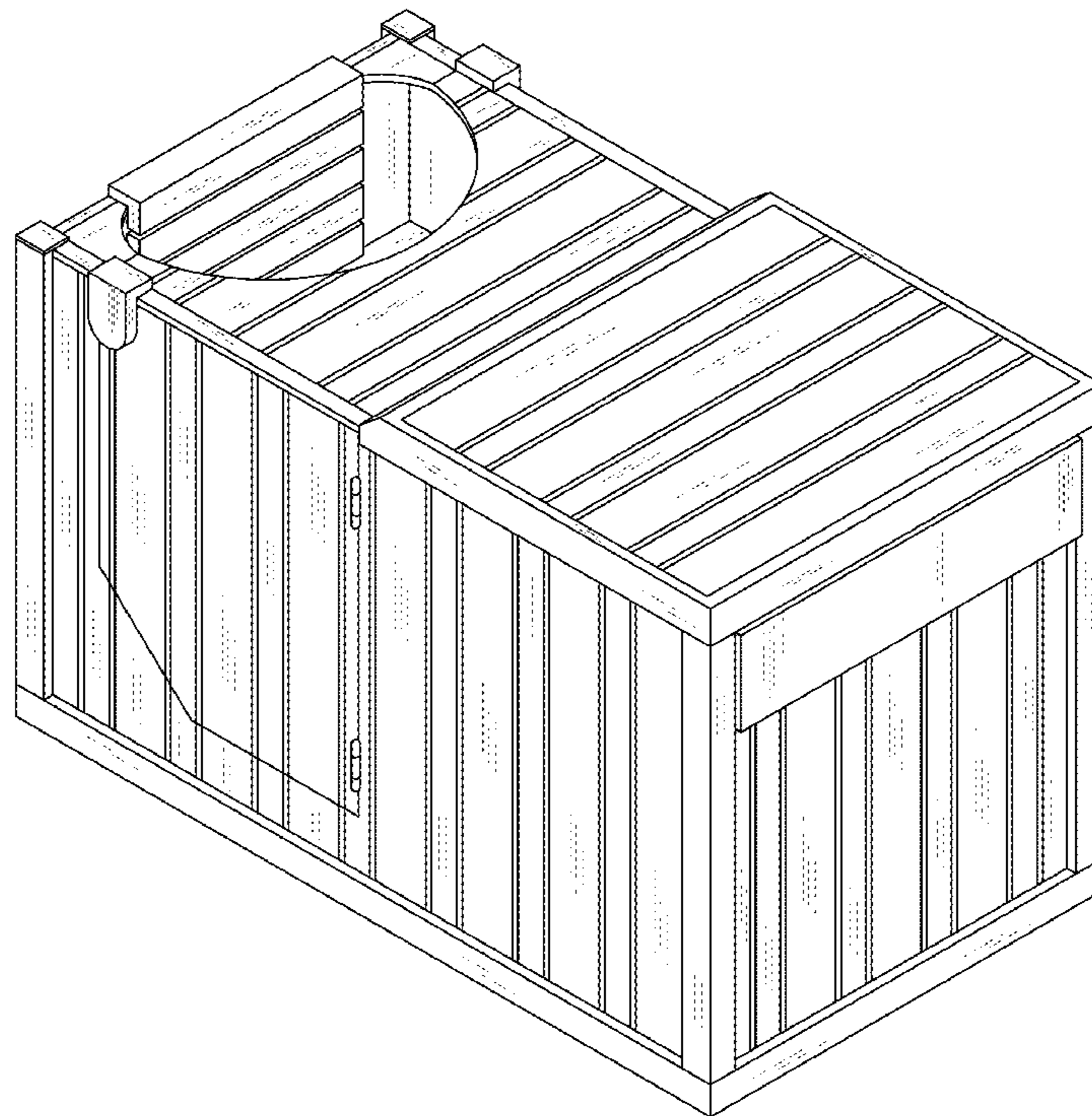

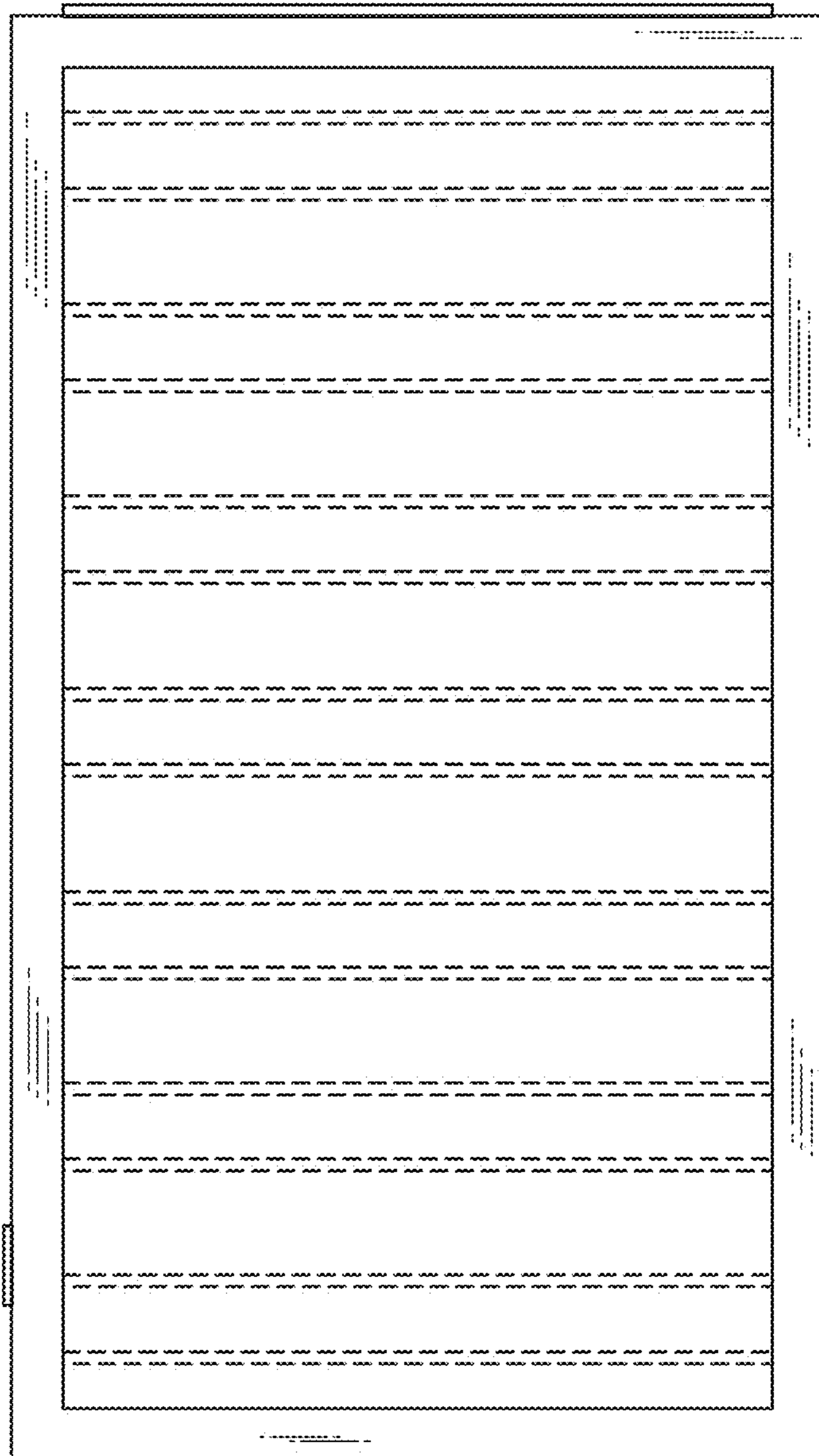

FIG. 1

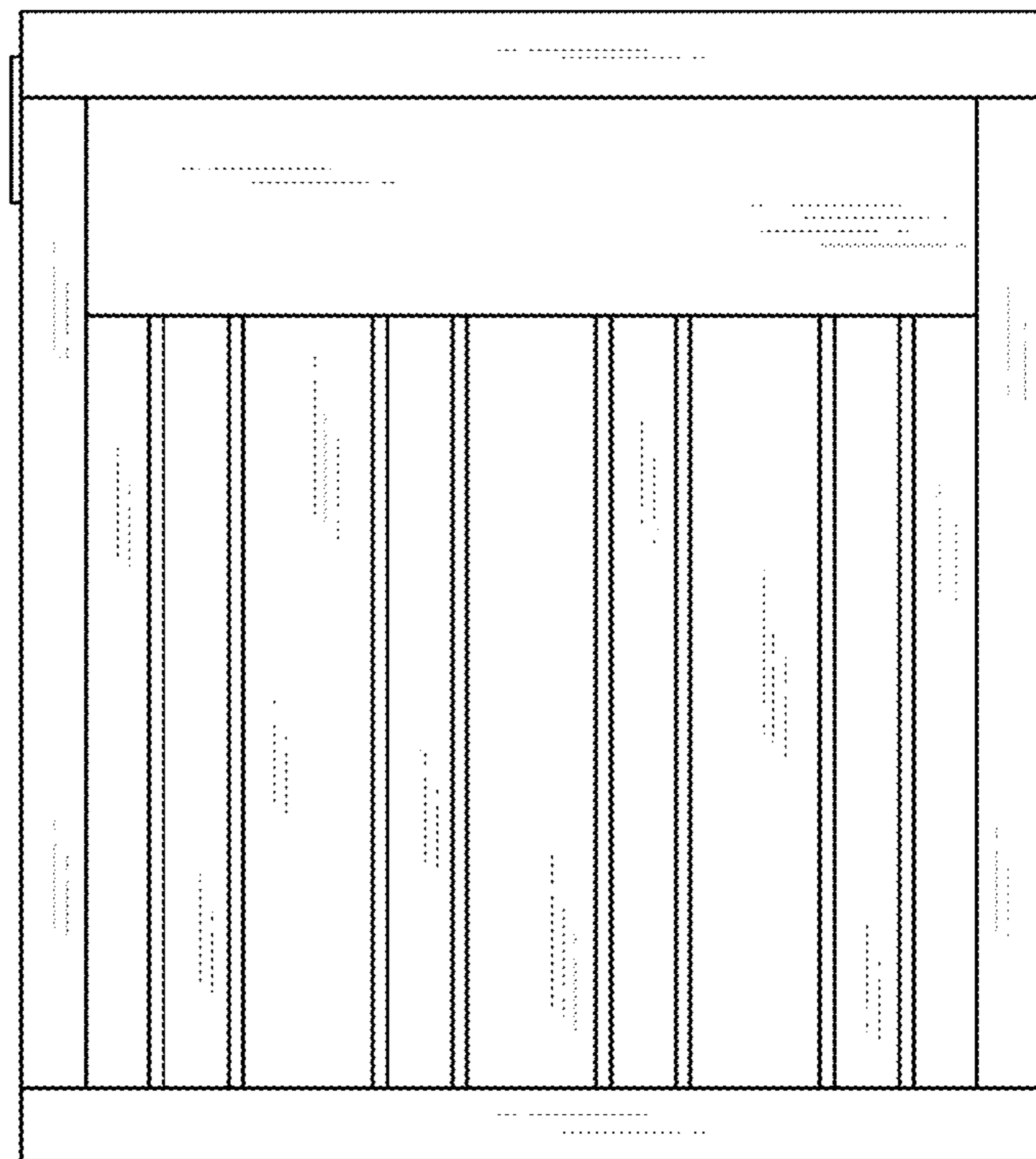

FIG. 2

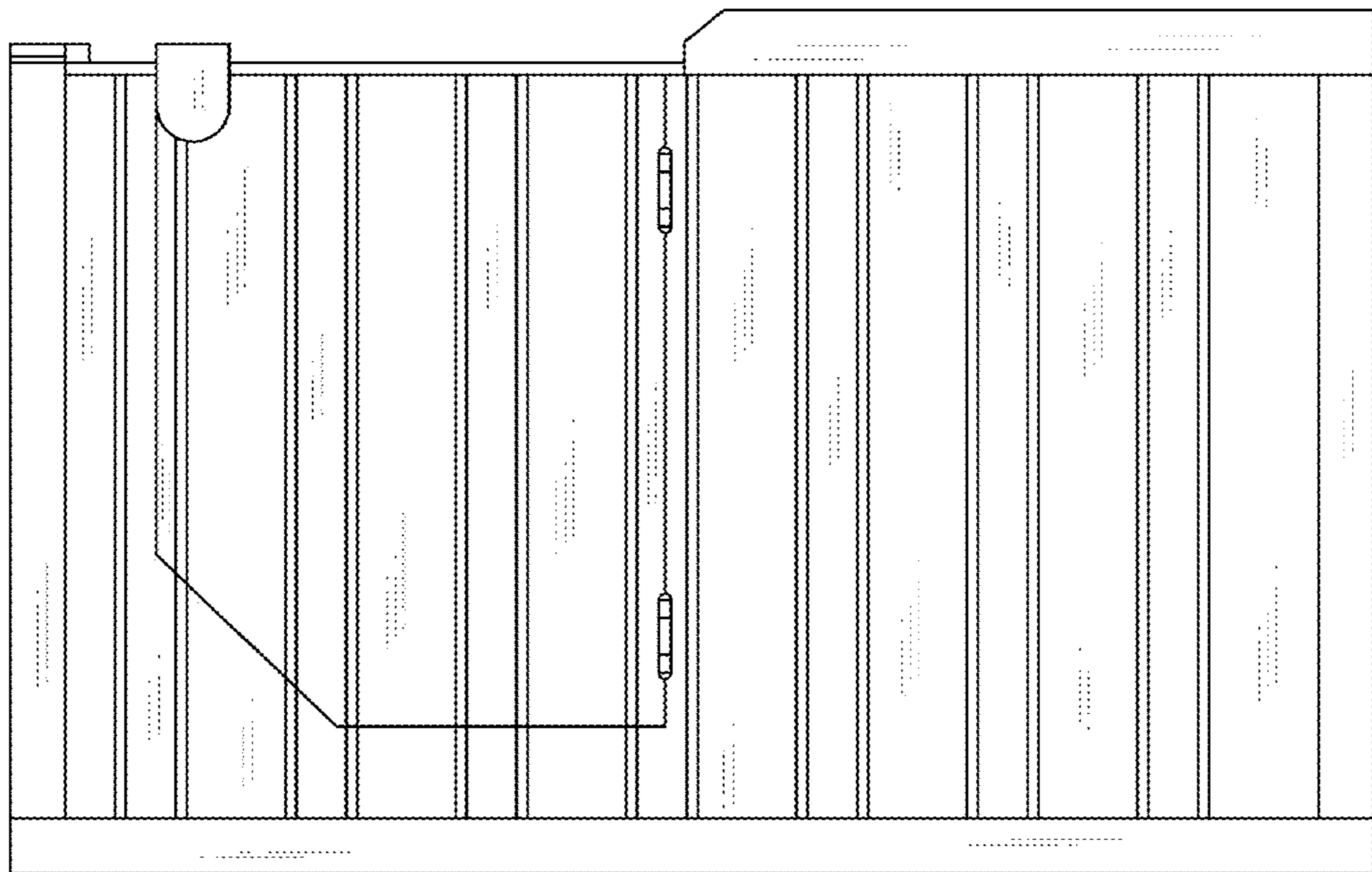

FIG. 3

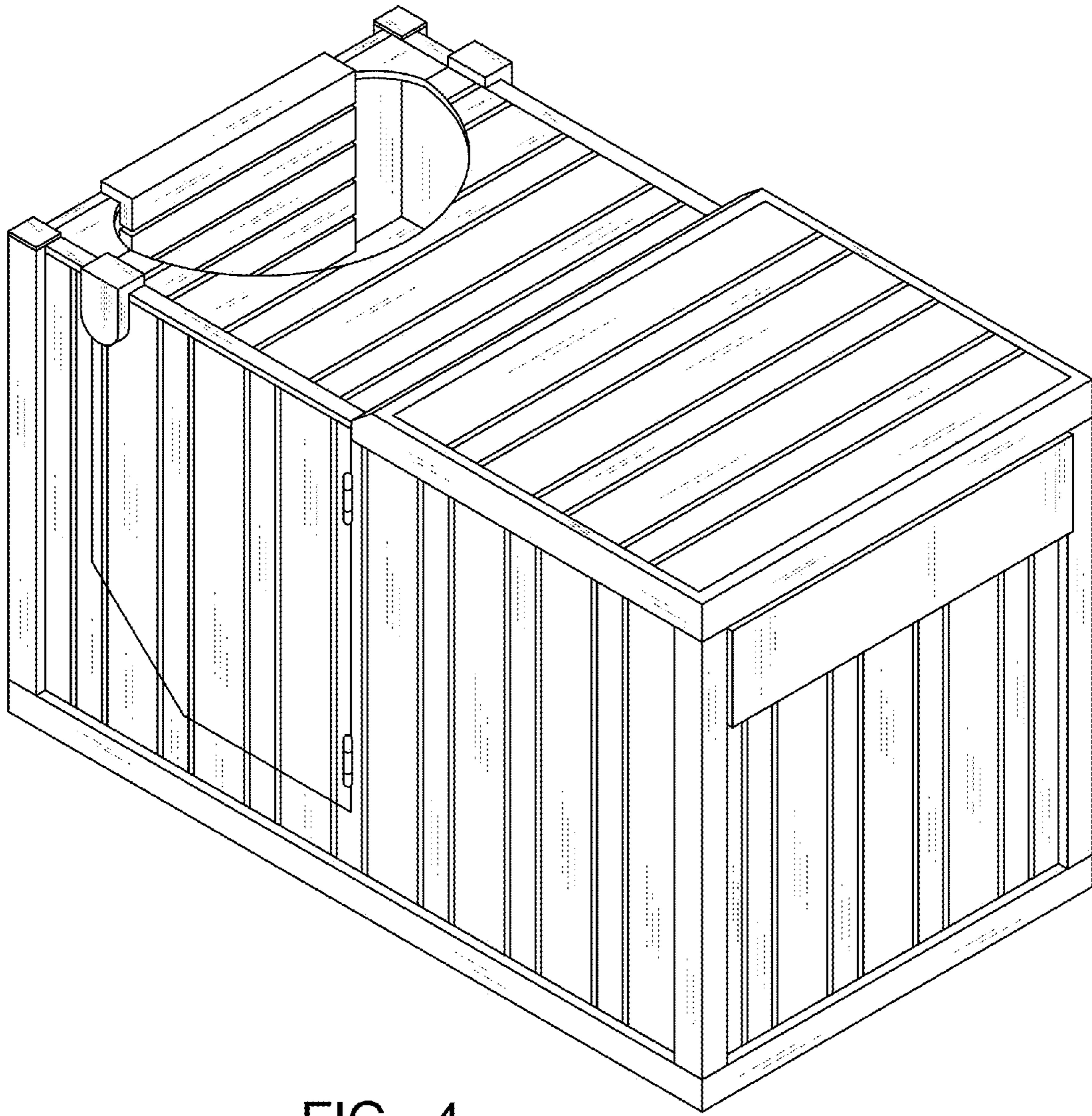

FIG. 4

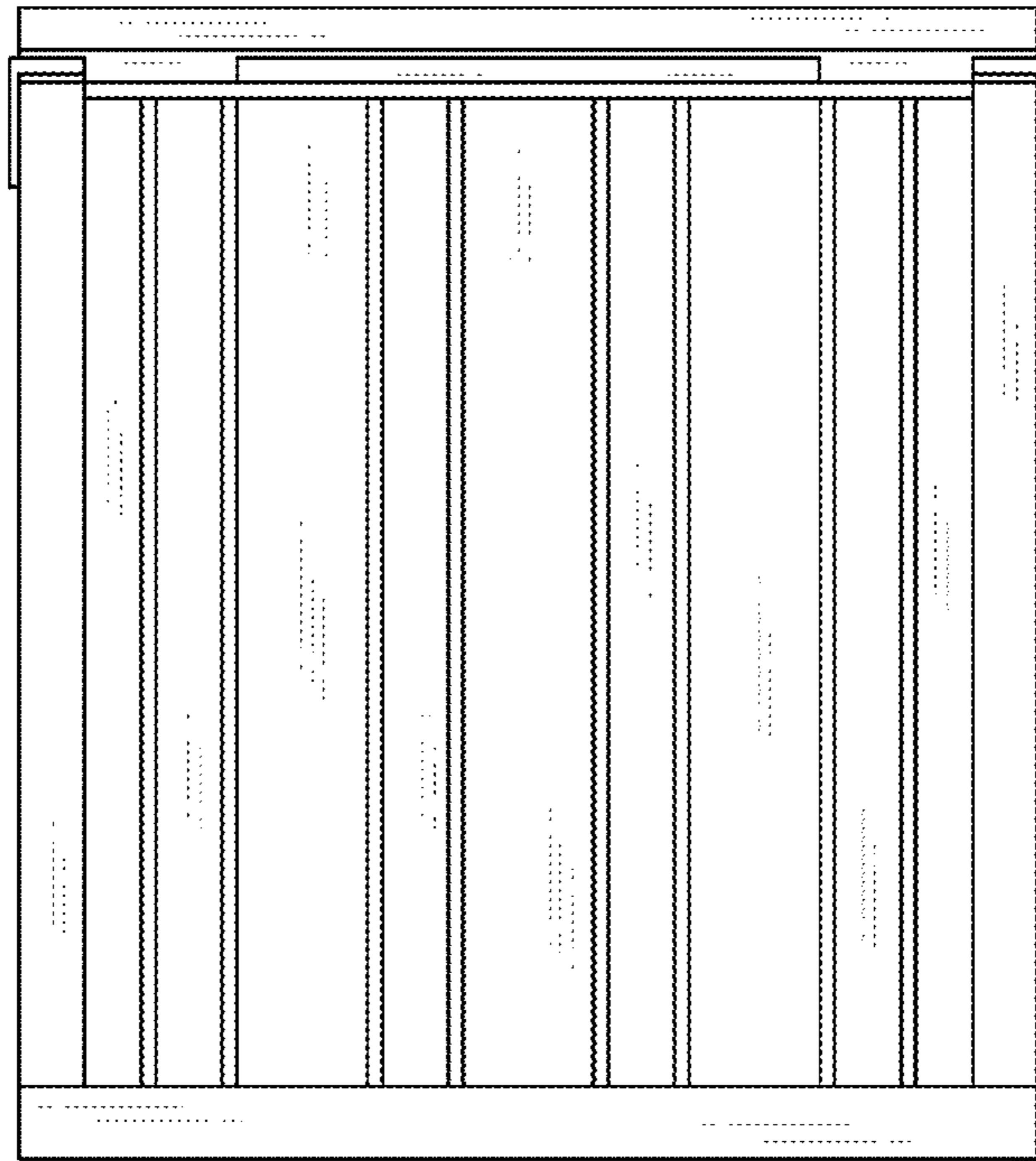

FIG. 5

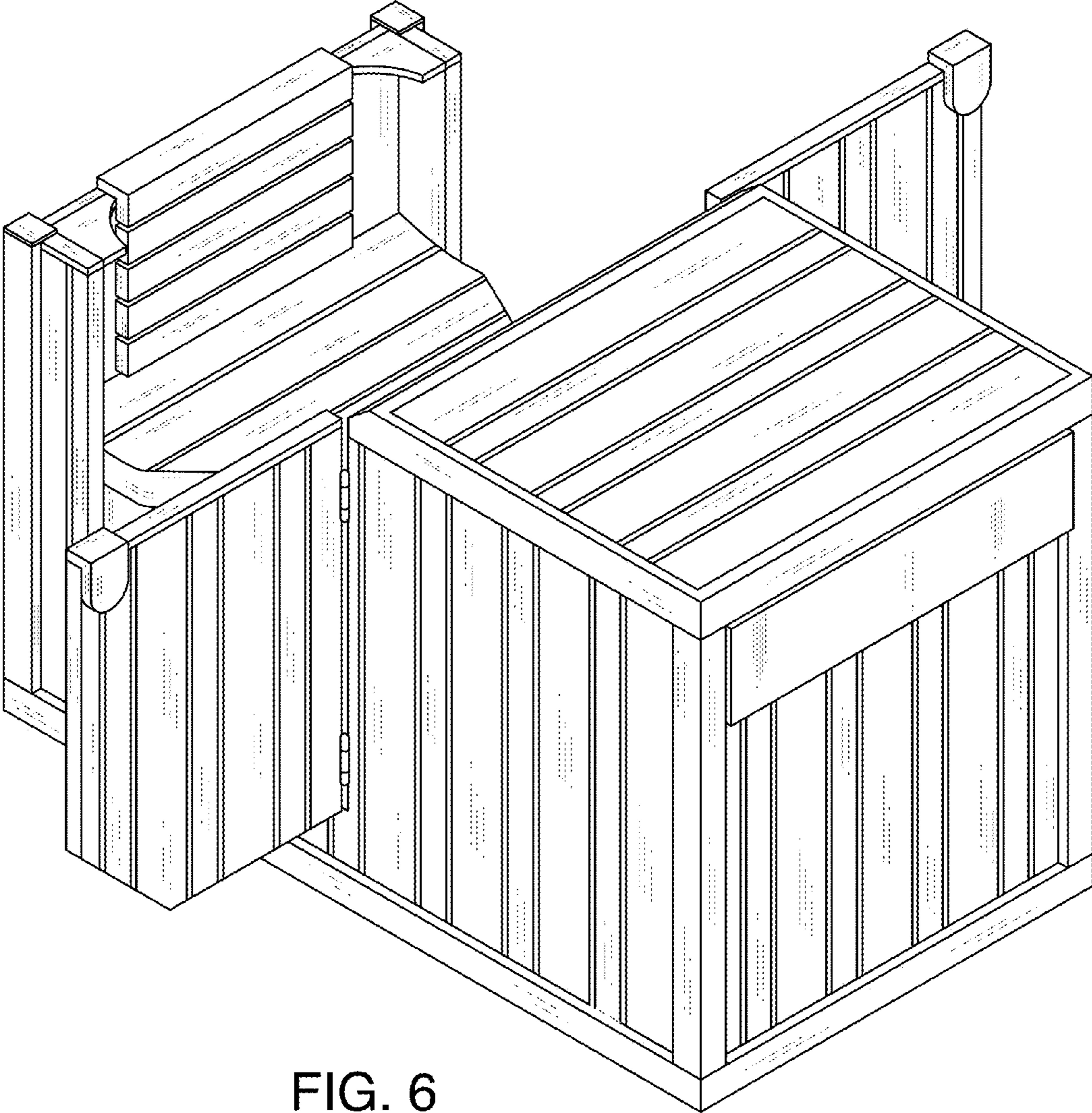

FIG. 6

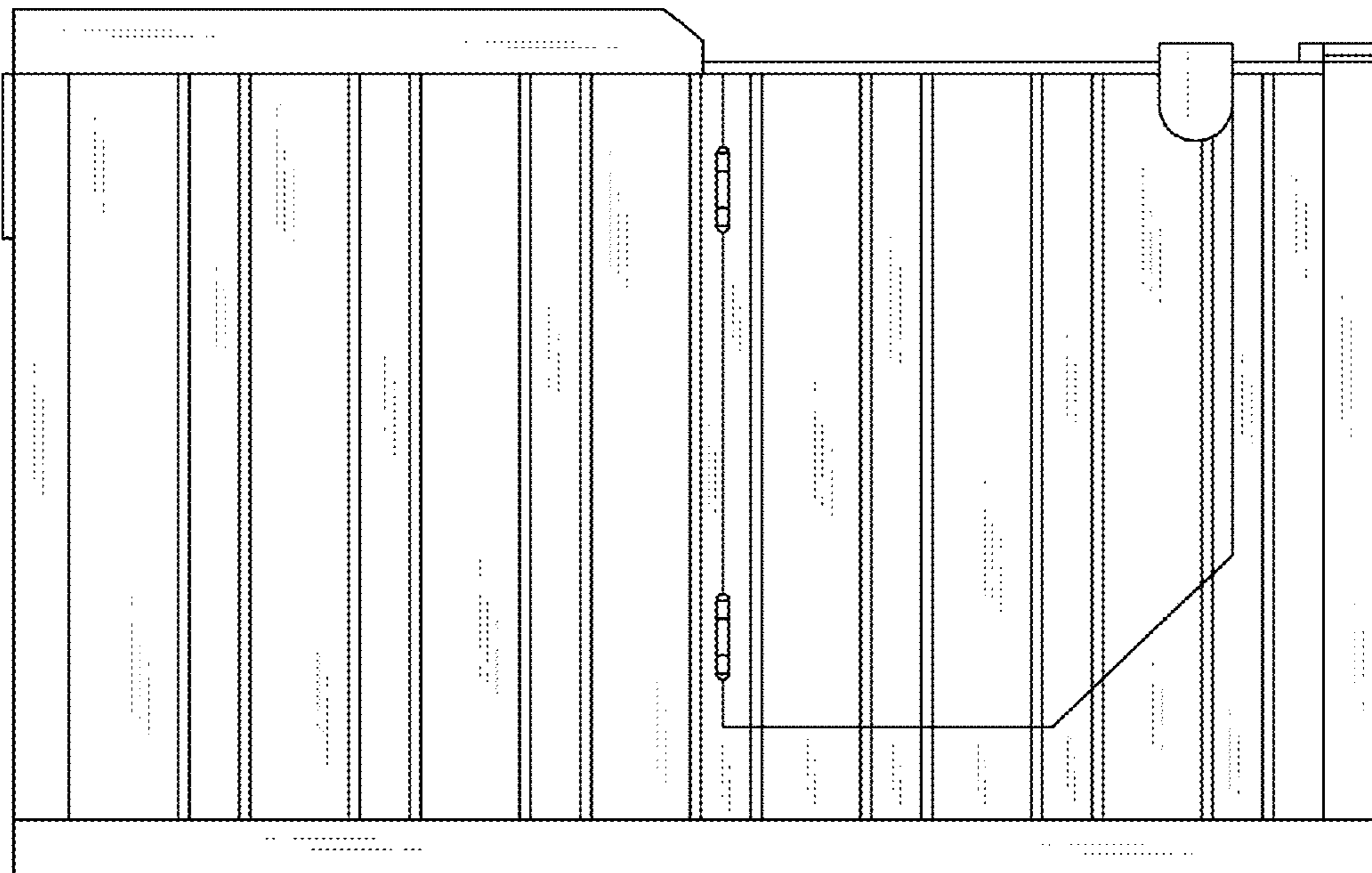

FIG. 7

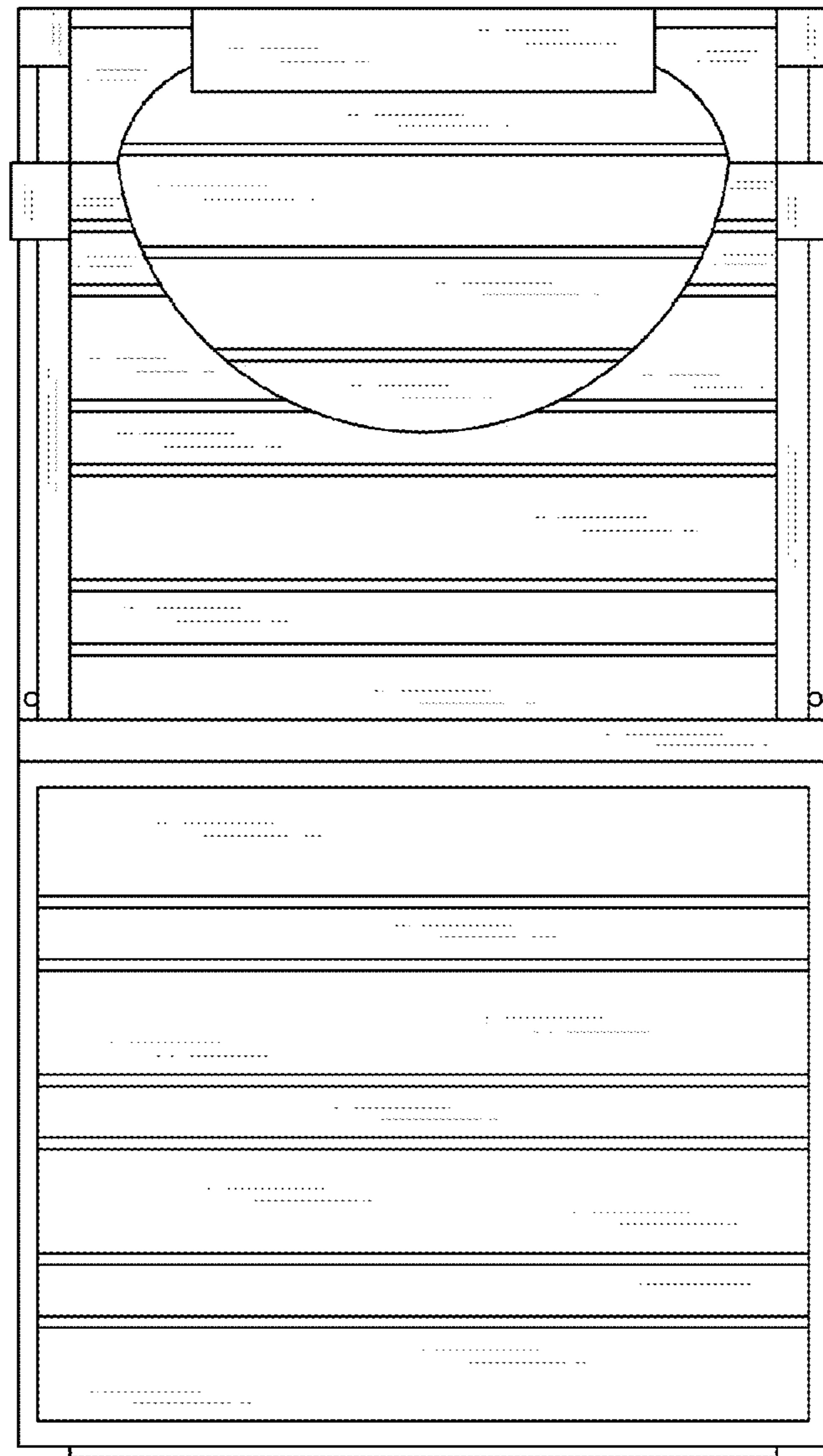

FIG. 8