



US00D745648S

(12) **United States Design Patent**  
**Paolo**

(10) **Patent No.:** **US D745,648 S**

(45) **Date of Patent:** **\*\* Dec. 15, 2015**

(54) **DROP IN SINK**

(71) Applicant: **RONBOW CORPORATION**, Fremont, CA (US)

(72) Inventor: **Pininfarina Paolo**, Cambiano (IT)

(73) Assignee: **Ronbow Corporation**, Fremont, CA (US)

(\*\*) Term: **14 Years**

(21) Appl. No.: **29/515,852**

(22) Filed: **Jan. 27, 2015**

(51) **LOC (10) Cl.** ..... **23-02**

(52) **U.S. Cl.**  
USPC ..... **D23/287**

(58) **Field of Classification Search**  
USPC ..... D23/271-274, 284, 286, 291-293.1, D23/303, 308, 287  
CPC ..... E03C 1/00; E03C 1/01; E03C 1/02; E03C 1/12; E03C 1/18  
See application file for complete search history.

(56) **References Cited**  
U.S. PATENT DOCUMENTS

D538,898 S *	3/2007	Trepanier	.....	D23/286
D663,016 S *	7/2012	Figurski	.....	D23/271
8,499,375 B2 *	8/2013	Kim	.....	F16L 25/08 239/463

\* cited by examiner

*Primary Examiner* — Robert Delehanty

(74) *Attorney, Agent, or Firm* — Thomas Schneck

(57) **CLAIM**

I claim the design for a drop in sink, as shown and described.

**DESCRIPTION**

FIG. 1 is a top front perspective view of a drop in sink of our design, the dashed lines representing unclaimed features; FIG. 2 is a top plan view thereof, the bottom plan view being plain, unornamented and unclaimed; FIG. 3 is a front elevational view thereof, the dashed lines representing unclaimed features; FIG. 4 is a right side elevational view thereof, the dashed lines representing unclaimed features; FIG. 5 is a rear elevational view thereof, the dashed lines representing unclaimed features; FIG. 6 is a left side elevational view thereof, the dashed lines representing unclaimed features; FIG. 7 is a cross sectional view taken along line 7-7 in FIG. 2, the dashed lines representing unclaimed features; and, FIG. 8 is a cross sectional view taken along line 8-8 in FIG. 2, the dashed lines representing unclaimed features. The broken lines shown in the drawings are included for the purpose of illustrating a portion of the sink that forms no part of the claimed design.

**1 Claim, 3 Drawing Sheets**

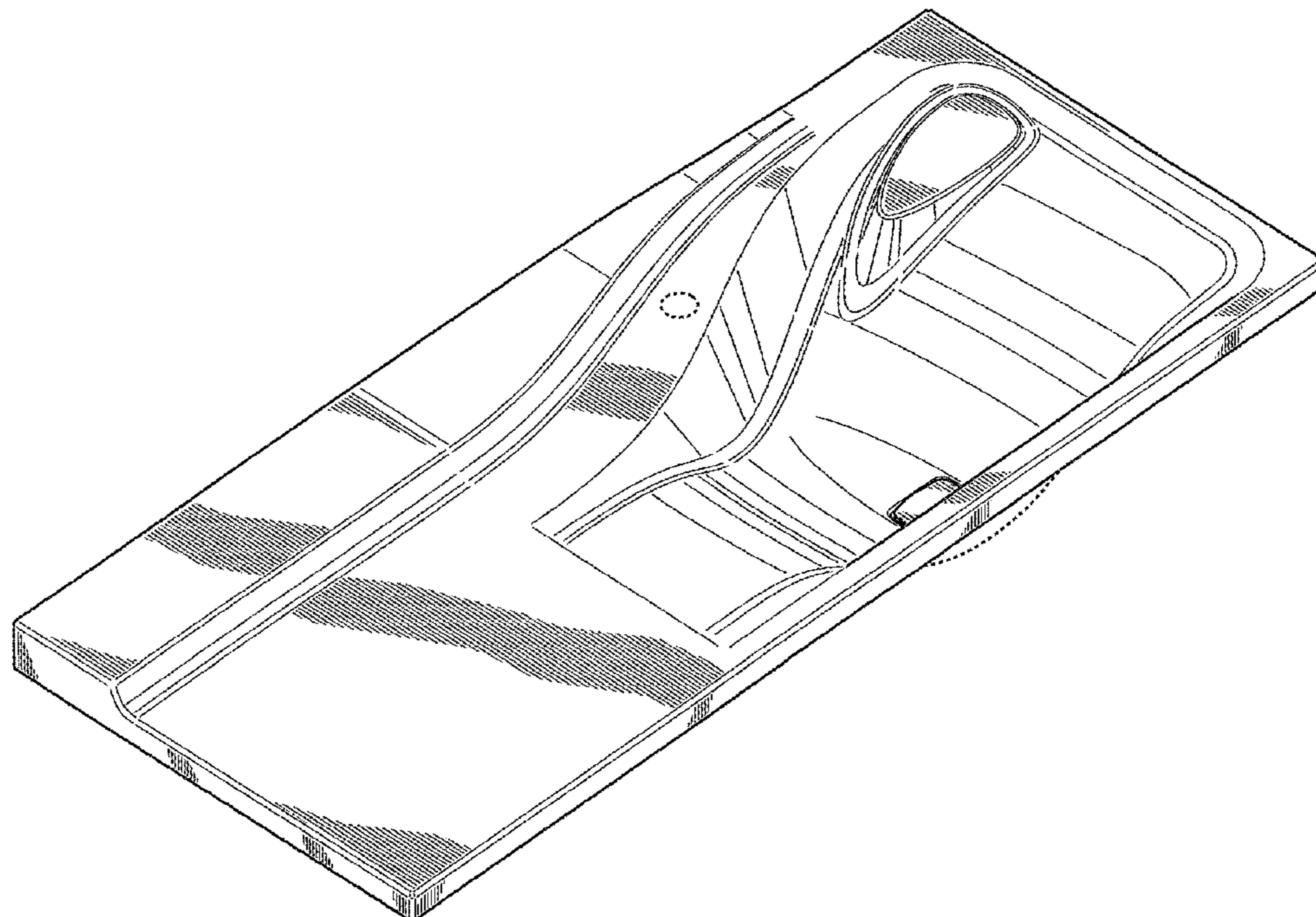

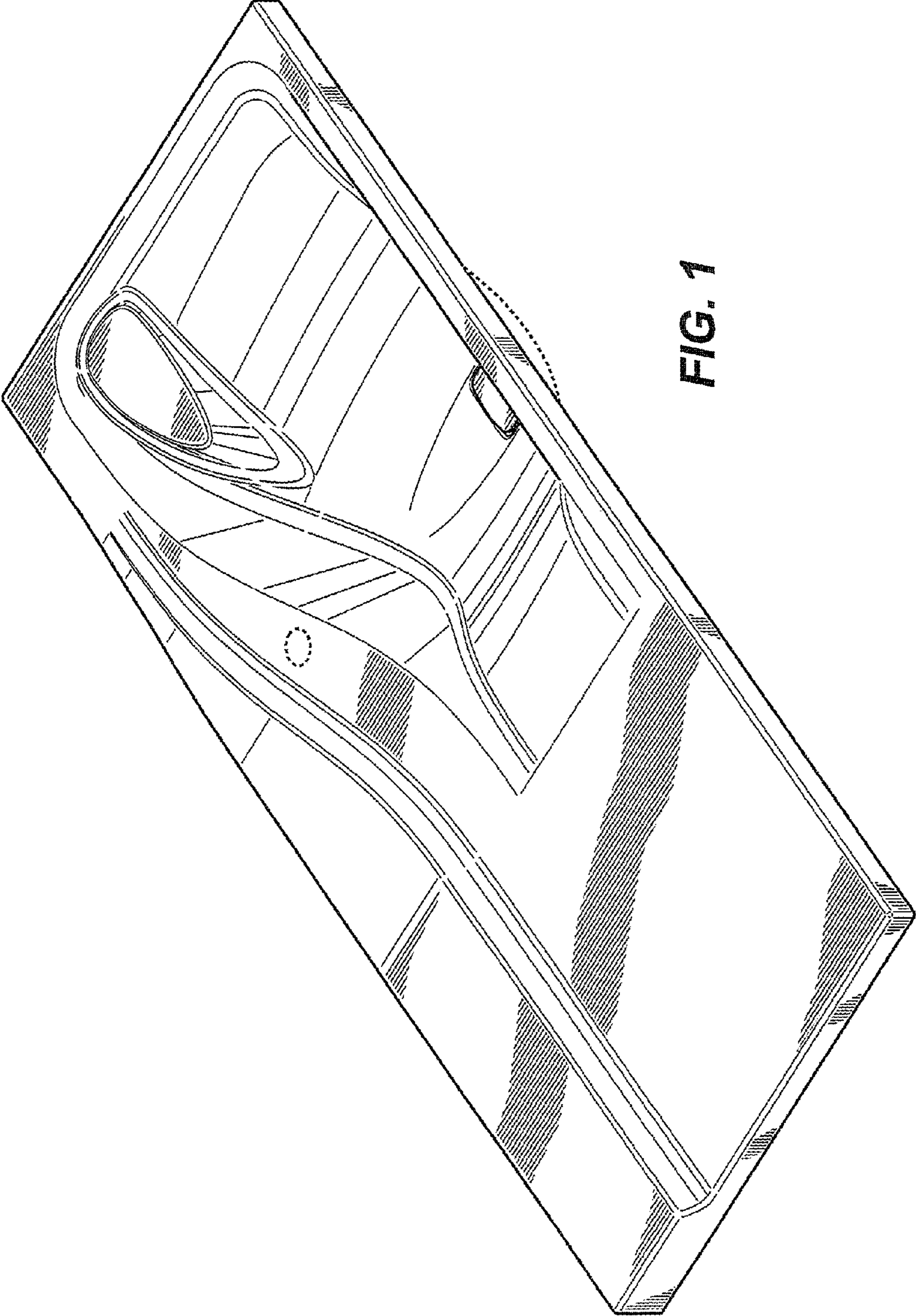
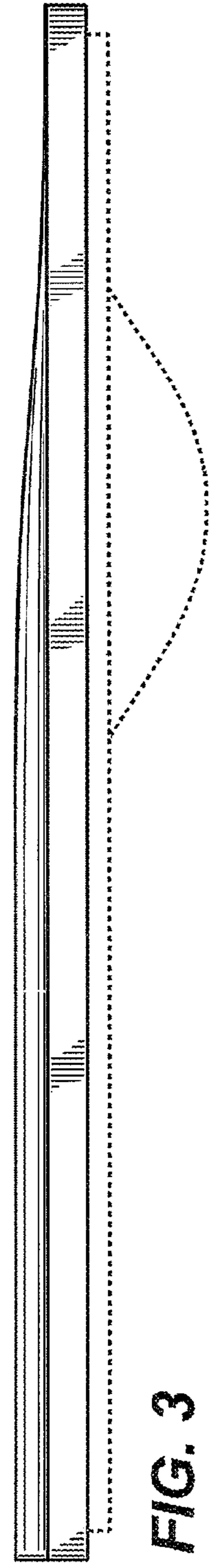
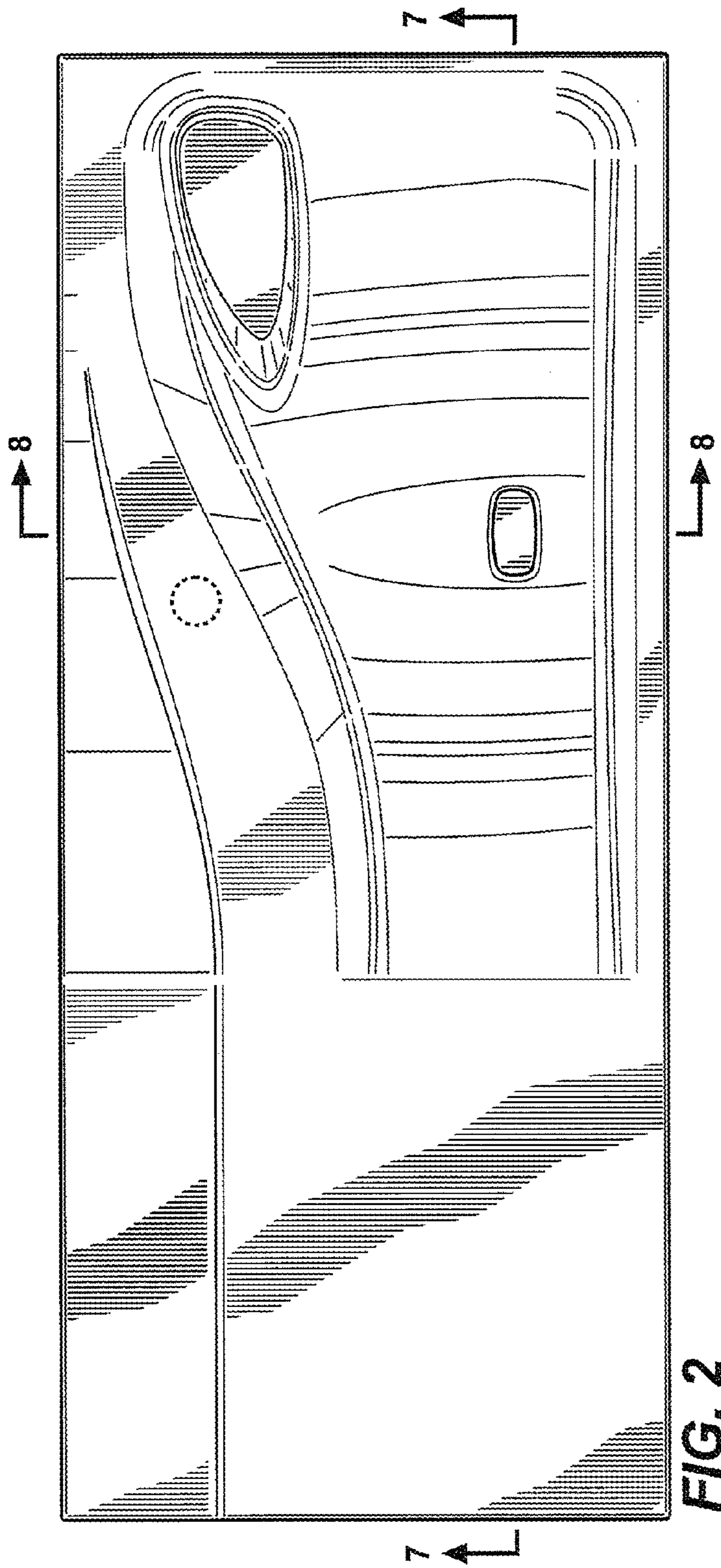
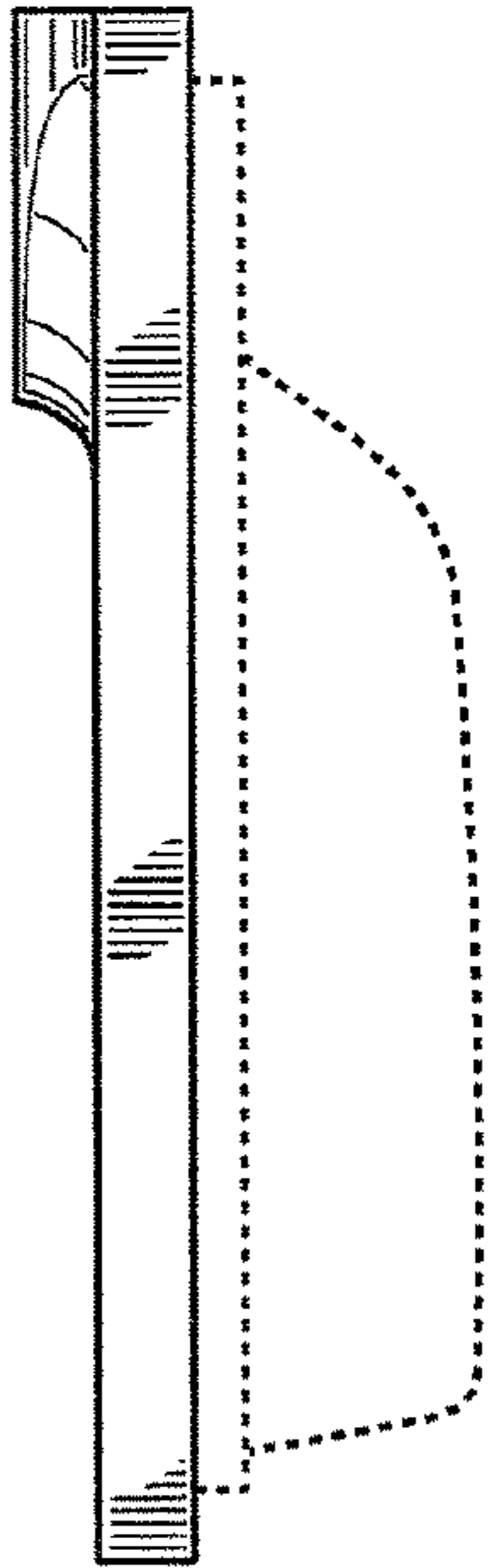
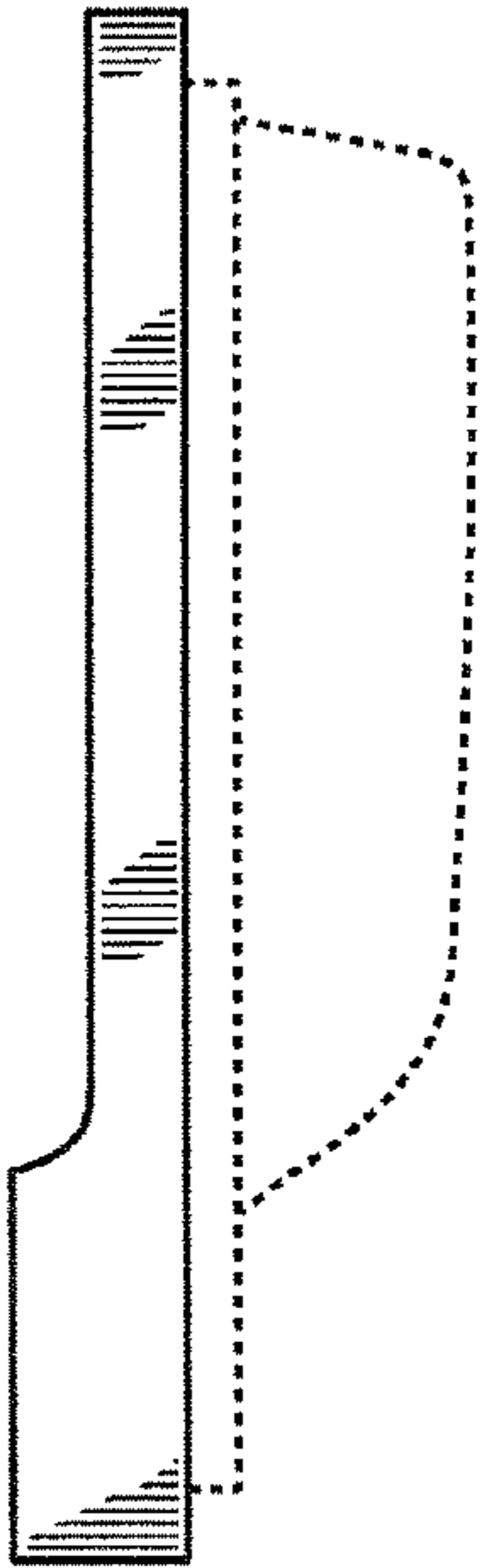

FIG. 1

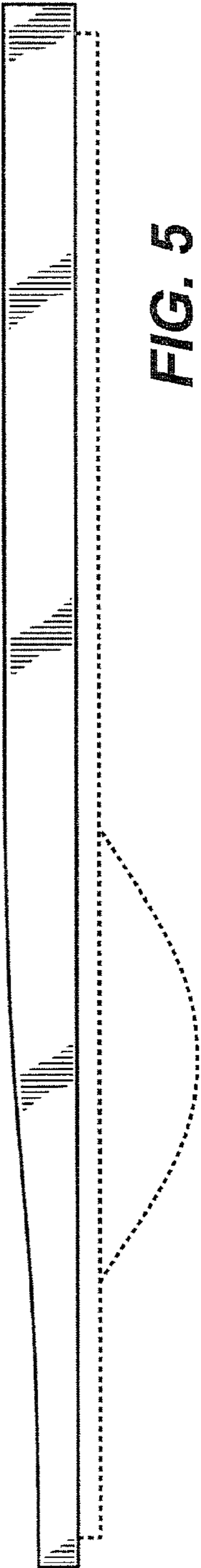



**FIG. 4**



**FIG. 6**



**FIG. 5**

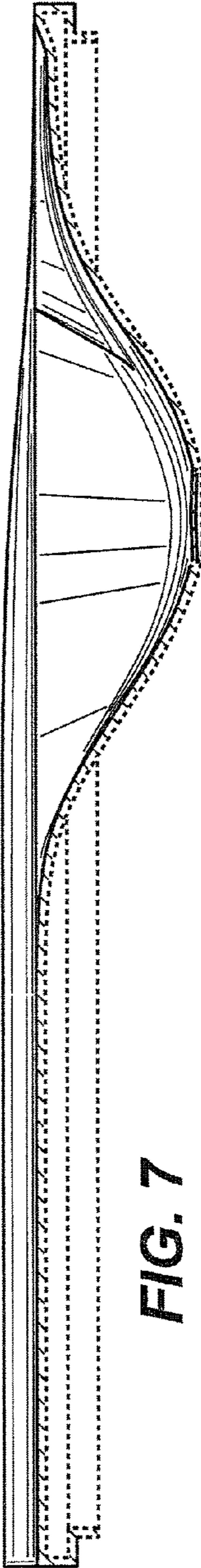

**FIG. 7**

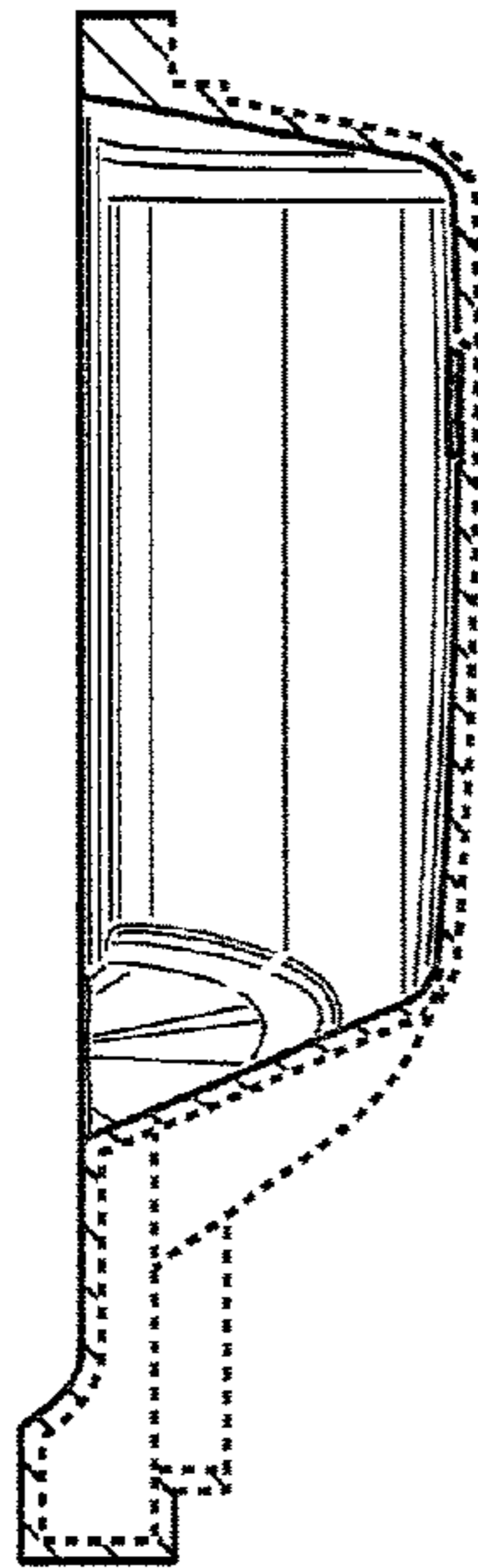

**FIG. 8**