



US00D745599S

(12) **United States Design Patent**
Tanaka et al.

(10) **Patent No.:** **US D745,599 S**
(45) **Date of Patent:** **** Dec. 15, 2015**

(54) **TAPE PRINTING MACHINE**

(71) Applicants: **Hiromitsu Tanaka**, Nagoya (JP);
Nobuyuki Iwai, Chita-gun (JP); **Jihoon Kil**, Nagoya (JP)

(72) Inventors: **Hiromitsu Tanaka**, Nagoya (JP);
Nobuyuki Iwai, Chita-gun (JP); **Jihoon Kil**, Nagoya (JP)

(73) Assignee: **BROTHER INDUSTRIES, LTD.**,
Nagoya (JP)

(**) Term: **14 Years**

(21) Appl. No.: **29/481,060**

(22) Filed: **Jan. 31, 2014**

(30) **Foreign Application Priority Data**

Aug. 2, 2013 (JP) 2013-017660
Dec. 4, 2013 (JP) 2013-028387

(51) **LOC (10) Cl.** **18-99**

(52) **U.S. Cl.**
USPC **D18/19; D18/52**

(58) **Field of Classification Search**
USPC D18/6-7, 14, 19, 50, 52, 54.1, 54, 55;
D14/347, 420-426, 462-470; 400/613,
400/613.1-613.4, 690.1-690.4, 691-694,
400/619; D19/68

See application file for complete search history.

(56) **References Cited**

U.S. PATENT DOCUMENTS

D363,082	S	*	10/1995	Watanabe et al.	D18/19
D379,971	S	*	6/1997	Jones et al.	D14/347
7,513,706	B2	*	4/2009	Kimura et al.	400/693
D601,182	S	*	9/2009	Mita et al.	D18/19
D632,329	S	*	2/2011	Thaler et al.	D18/19
D662,970	S	*	7/2012	Nakayama et al.	D18/19
D701,562	S	*	3/2014	Inada	D18/52

* cited by examiner

Primary Examiner — Cathy A MacCormac

(74) *Attorney, Agent, or Firm* — Oliff PLC

(57) **CLAIM**

The ornamental design for a tape printing machine, as shown and described.

DESCRIPTION

FIG. 1 is a perspective view of a tape printing machine; FIG. 2 is a front view thereof; FIG. 3 is a top view thereof; FIG. 4 is a right-side view thereof; FIG. 5 is a left-side view thereof; FIG. 6 is a rear view thereof; and, FIG. 7 is a bottom view thereof. The broken lines depict environmental subject matter only and form no part of the claimed design.

1 Claim, 4 Drawing Sheets

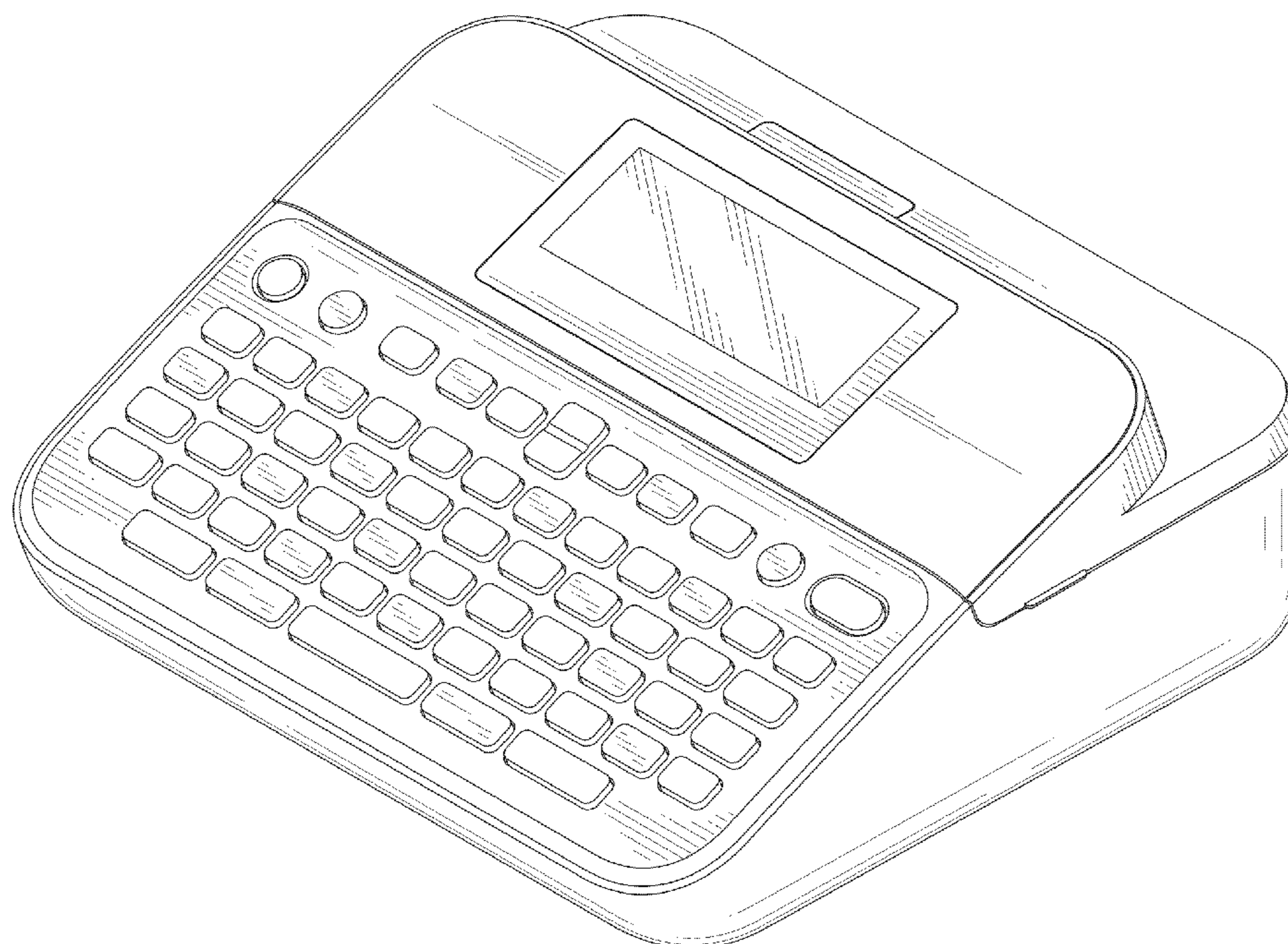

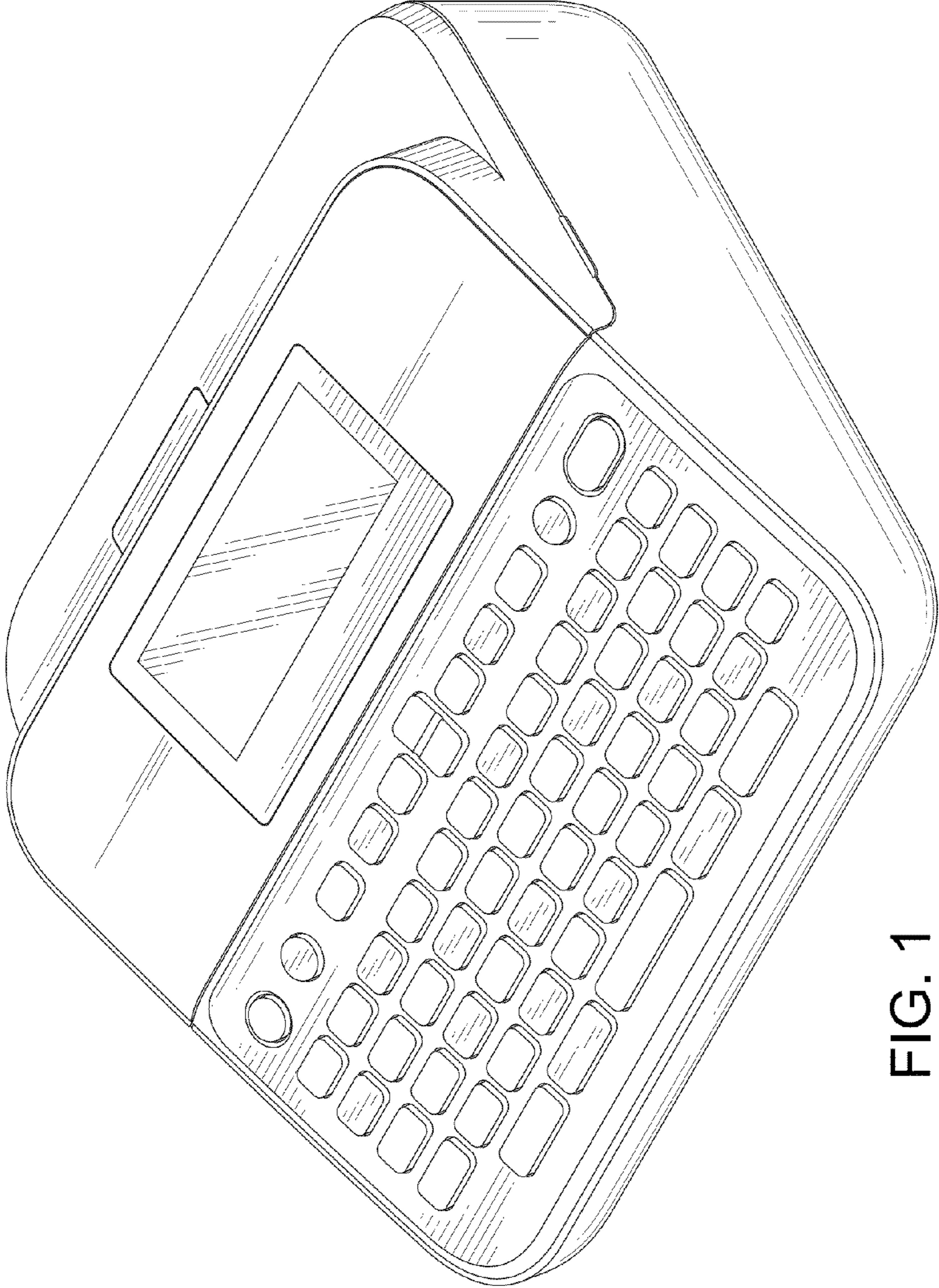

FIG. 1

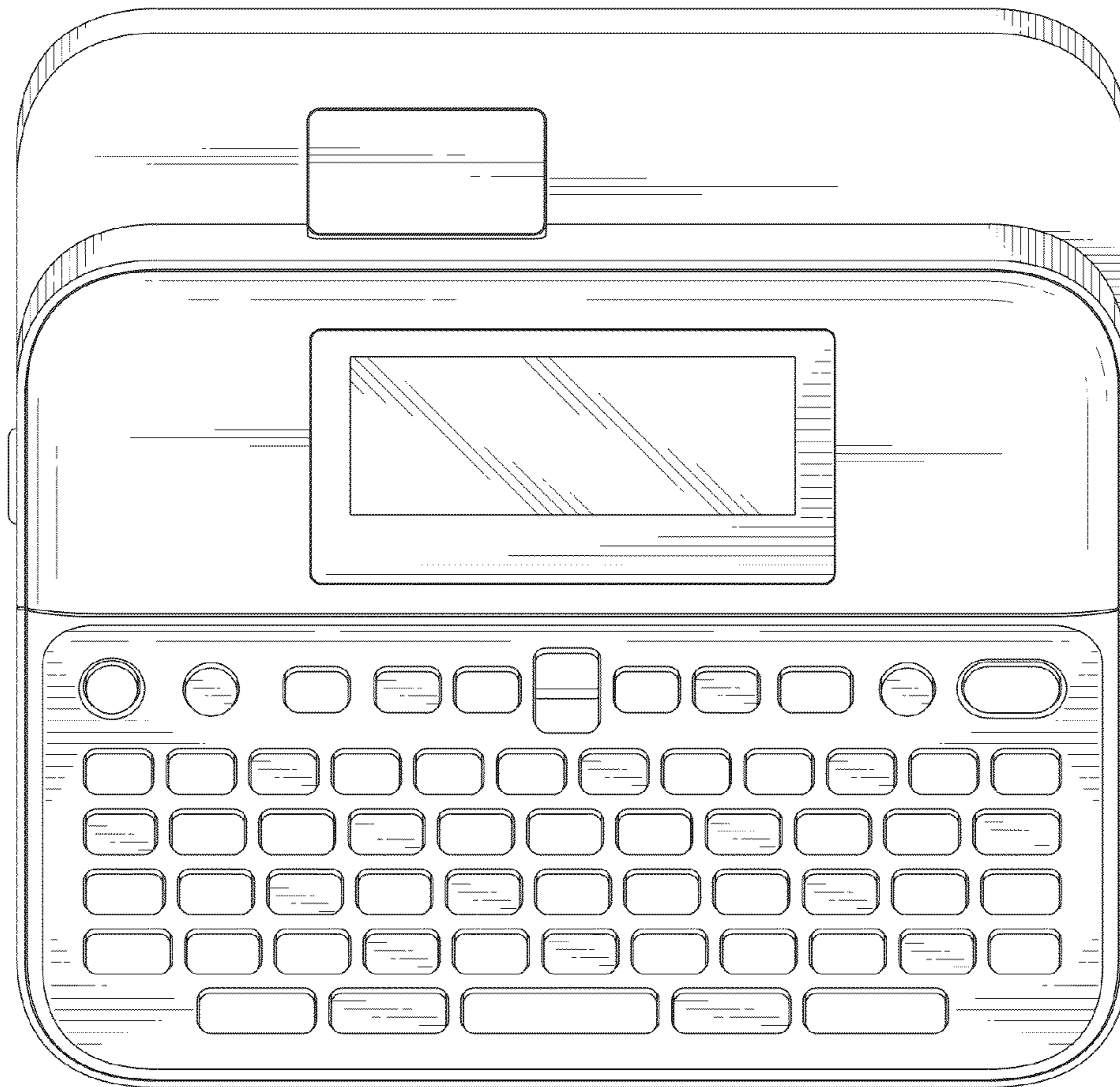

FIG. 3

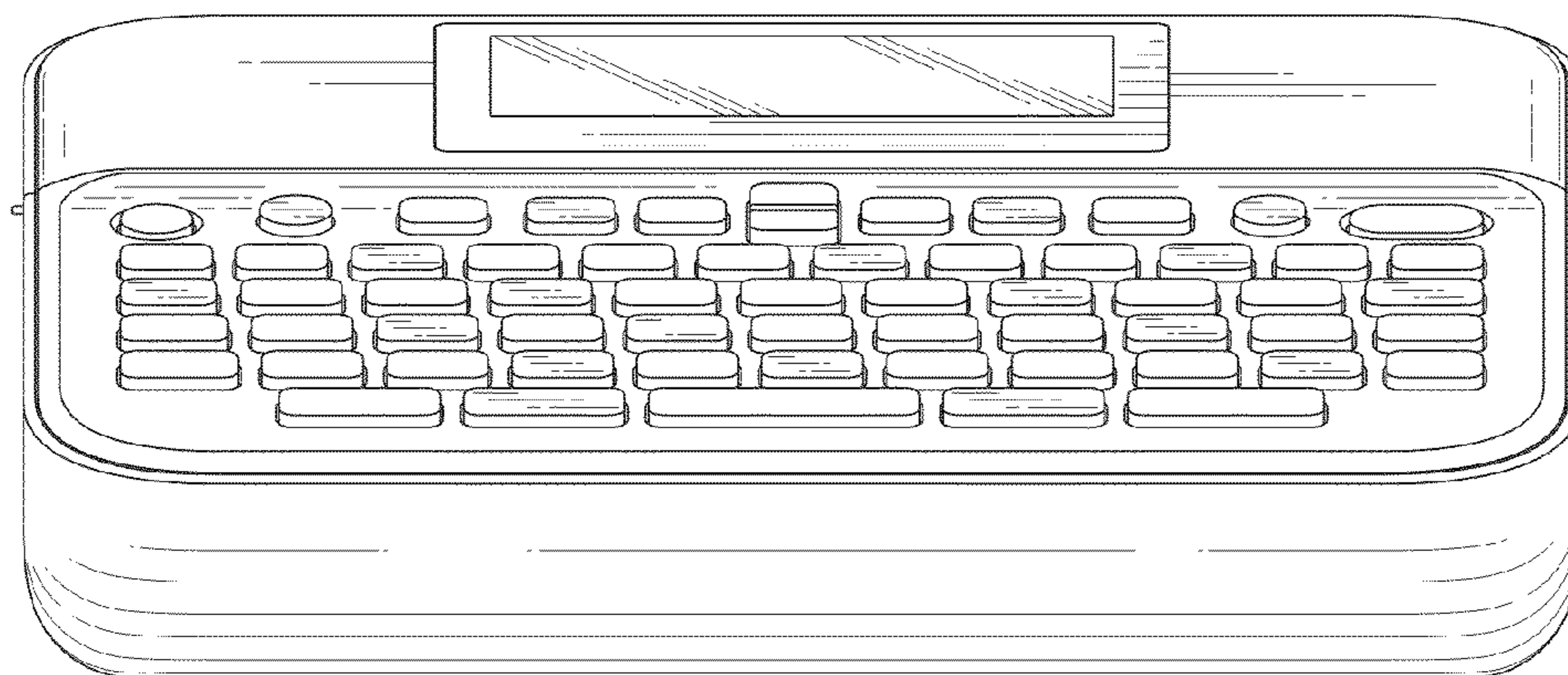

FIG. 2

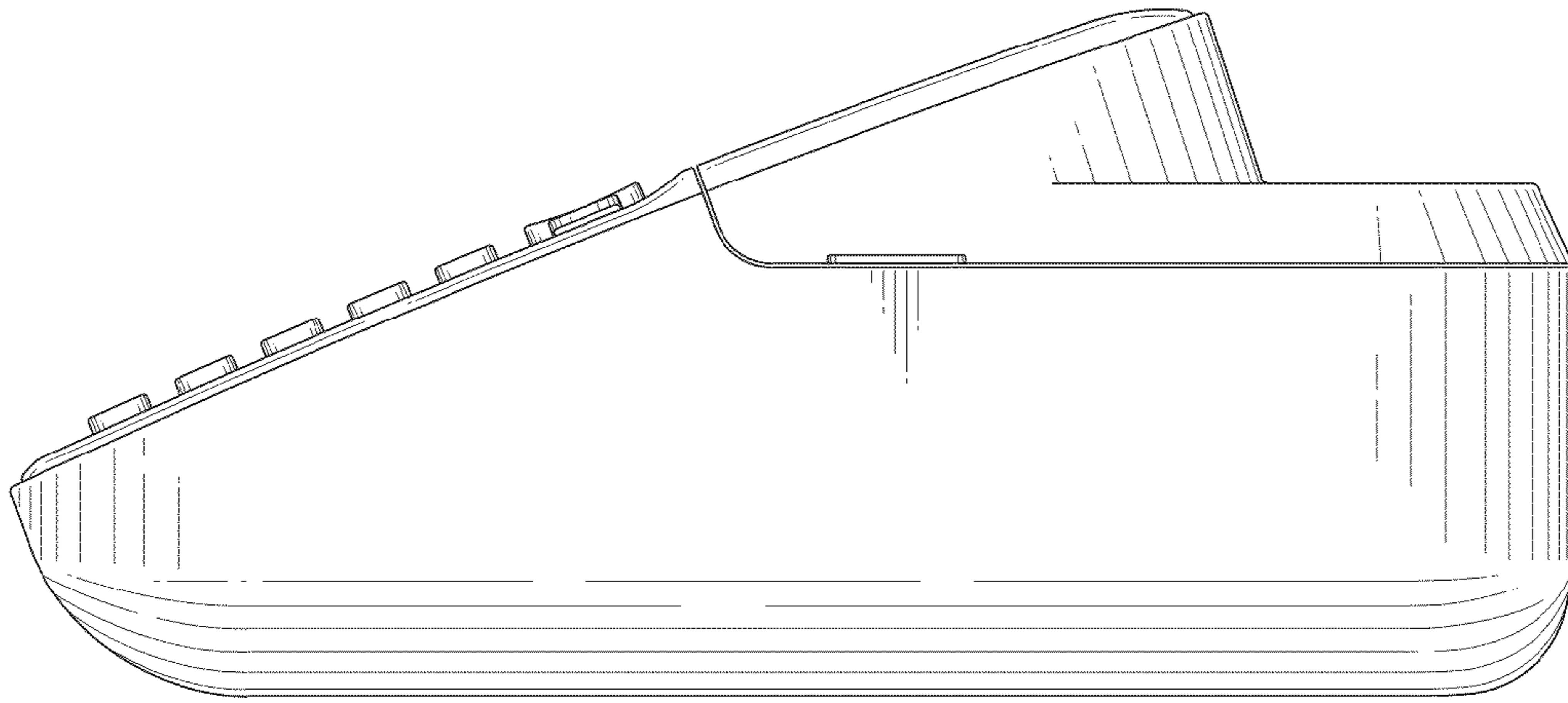

FIG. 4

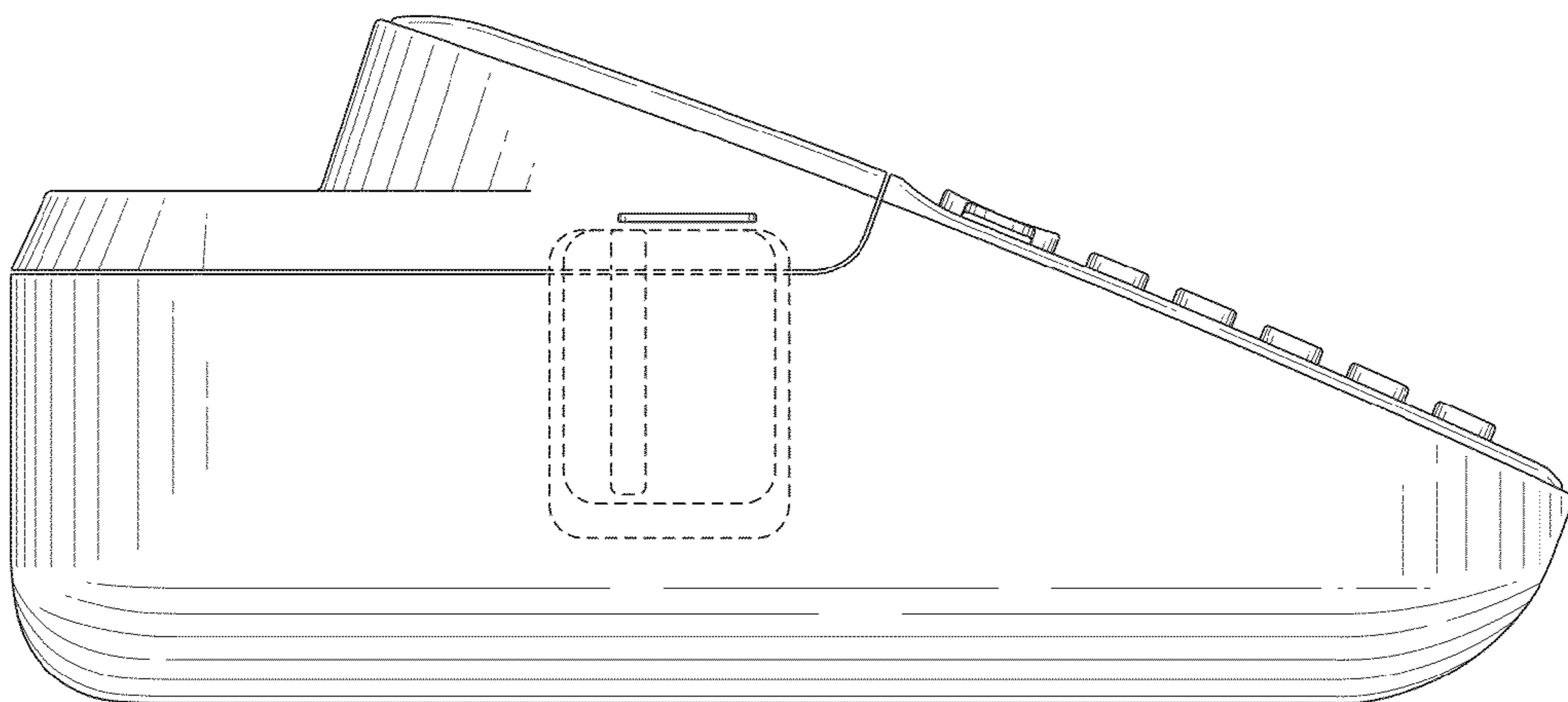

FIG. 5

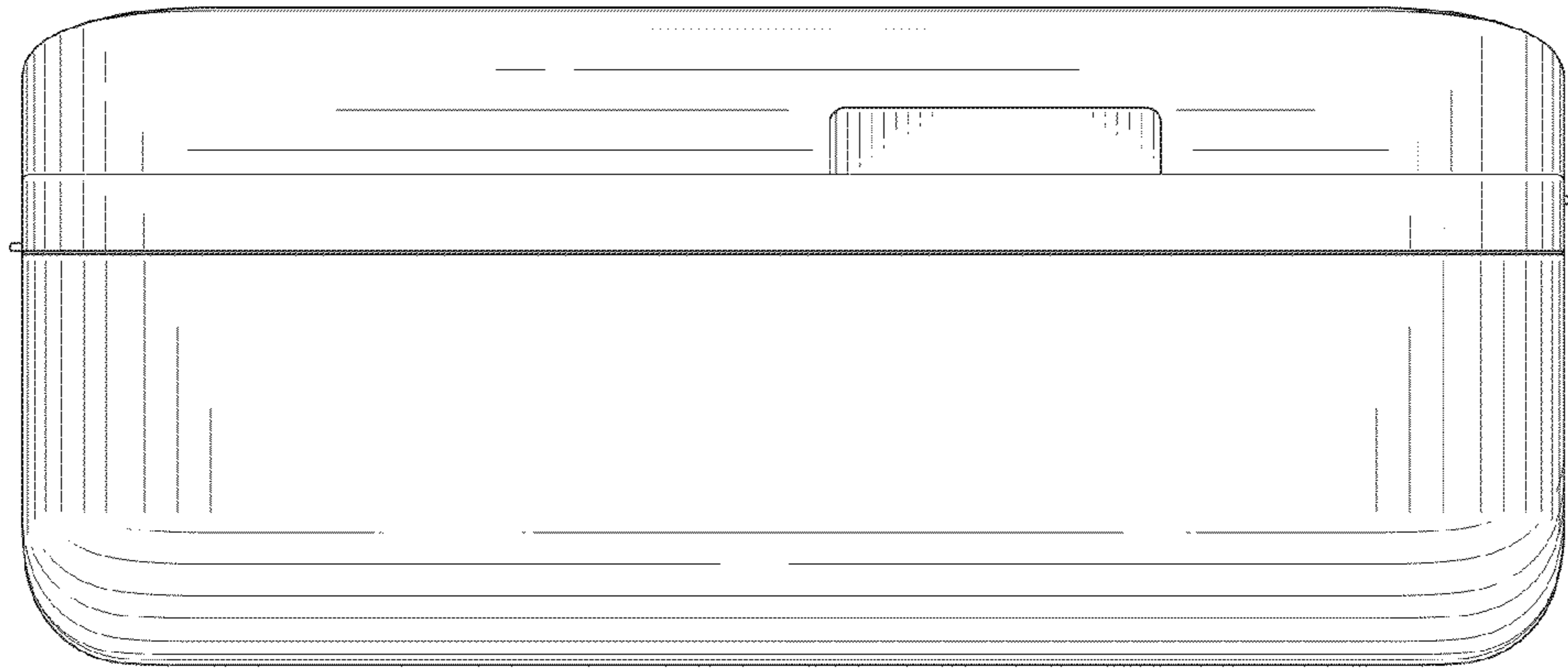

FIG. 6

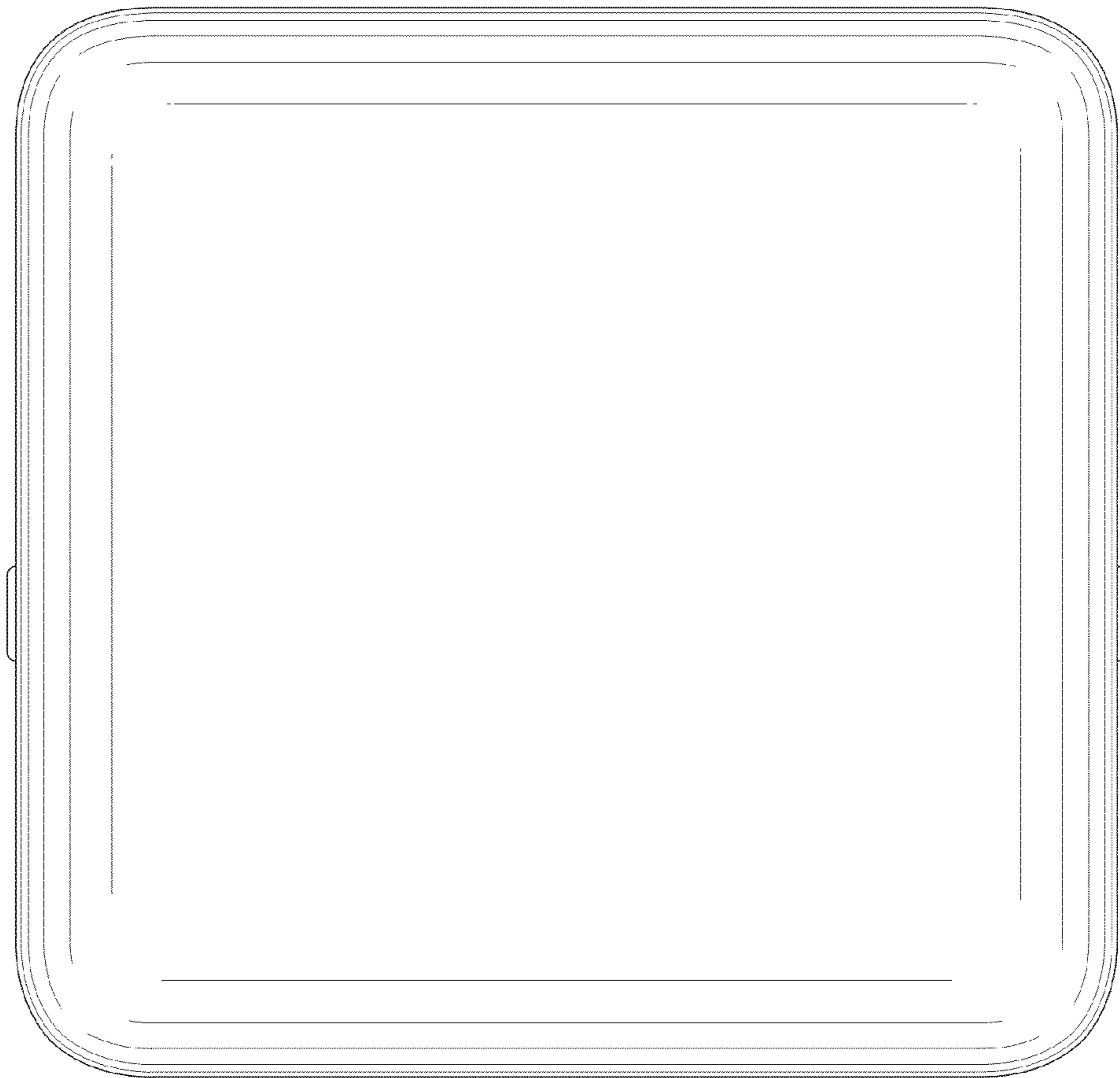

FIG. 7