



US00D745598S

(12) **United States Design Patent**
Nakayama et al.

(10) **Patent No.:** **US D745,598 S**
(45) **Date of Patent:** **** Dec. 15, 2015**

(54) **LABEL PRINTER**

(71) Applicant: **SEIKO EPSON CORPORATION**,
Tokyo (JP)

(72) Inventors: **Tetsu Nakayama**, Matsumoto (JP);
Haruki Sugawara, Matsumoto (JP);
Saeko Inoue, Matsumoto (JP);
Tomoyuki Kubota, Matsumoto (JP);
Daisuke Sato, Azumino (JP)

(73) Assignee: **SEIKO EPSON CORPORATION**,
Tokyo (JP)

(**) Term: **14 Years**

(21) Appl. No.: **29/466,280**

(22) Filed: **Sep. 6, 2013**

(30) **Foreign Application Priority Data**

Mar. 29, 2013 (JP) 2013-007100

(51) **LOC (10) Cl.** **18-99**

(52) **U.S. Cl.**
USPC **D18/19; D18/50**

(58) **Field of Classification Search**

USPC D18/50, 14, 19, 54, 36-37; D19/68;
D14/314, 332, 348-349, 351, 352

CPC B41J 3/4075; B65C 11/00; B65C 11/02;
B65C 11/0205; B65C 11/021; B65C 11/0215;
B65C 11/0221; B65C 11/0226; B65C
11/0231; B65C 11/0236; B65C 11/0242;
B65C 11/0252; B65C 11/0257; B65C
11/0268; B65C 11/0273; B65C 11/0284;
B65C 11/0289; B65C 11/0294; B65C 11/04;
B65C 11/046; B65C 11/06; B65C 11/062;
B65C 11/064; B65C 11/066; B65C 11/068

See application file for complete search history.

(56) **References Cited**

U.S. PATENT DOCUMENTS

5,267,800 A * 12/1993 Petteruti et al. 400/88
D362,673 S * 9/1995 Yamamoto D18/50

D487,743 S * 3/2004 Kim D14/349
D495,329 S * 8/2004 Peng et al. D14/352
D522,505 S * 6/2006 Sun et al. D14/349
D525,283 S * 7/2006 Nakaeda D18/19
D527,043 S * 8/2006 Borne et al. D18/50

(Continued)

FOREIGN PATENT DOCUMENTS

CN 302703931 * 1/2014

OTHER PUBLICATIONS

Youtube. <URL: <https://www.youtube.com/watch?v=hn01zZ8jbiw>>. May 7, 2014. Epson LabelWorks LW-600P label maker.*

Primary Examiner — Bridget L Eland
Assistant Examiner — Lauren McVey

(57) **CLAIM**

The ornamental design for a label printer, as shown and described.

DESCRIPTION

FIG. 1 is a front, top and right side perspective view of a label printer showing our new design;
FIG. 2 is a rear, top and left side perspective view thereof;
FIG. 3 is a front elevational view thereof;
FIG. 4 is a rear elevational view thereof;
FIG. 5 is a right side elevational view thereof;
FIG. 6 is a left side elevational view thereof;
FIG. 7 is a top plan view thereof;
FIG. 8 is a bottom plan view thereof; and,
FIG. 9 is a perspective view thereof with a cover in an open position.

The broken lines immediately adjacent the shaded areas represent the bounds of the claimed design while all other broken lines are directed to environment and are for illustrative purposes only; the broken lines form no part of the claimed design.

1 Claim, 9 Drawing Sheets

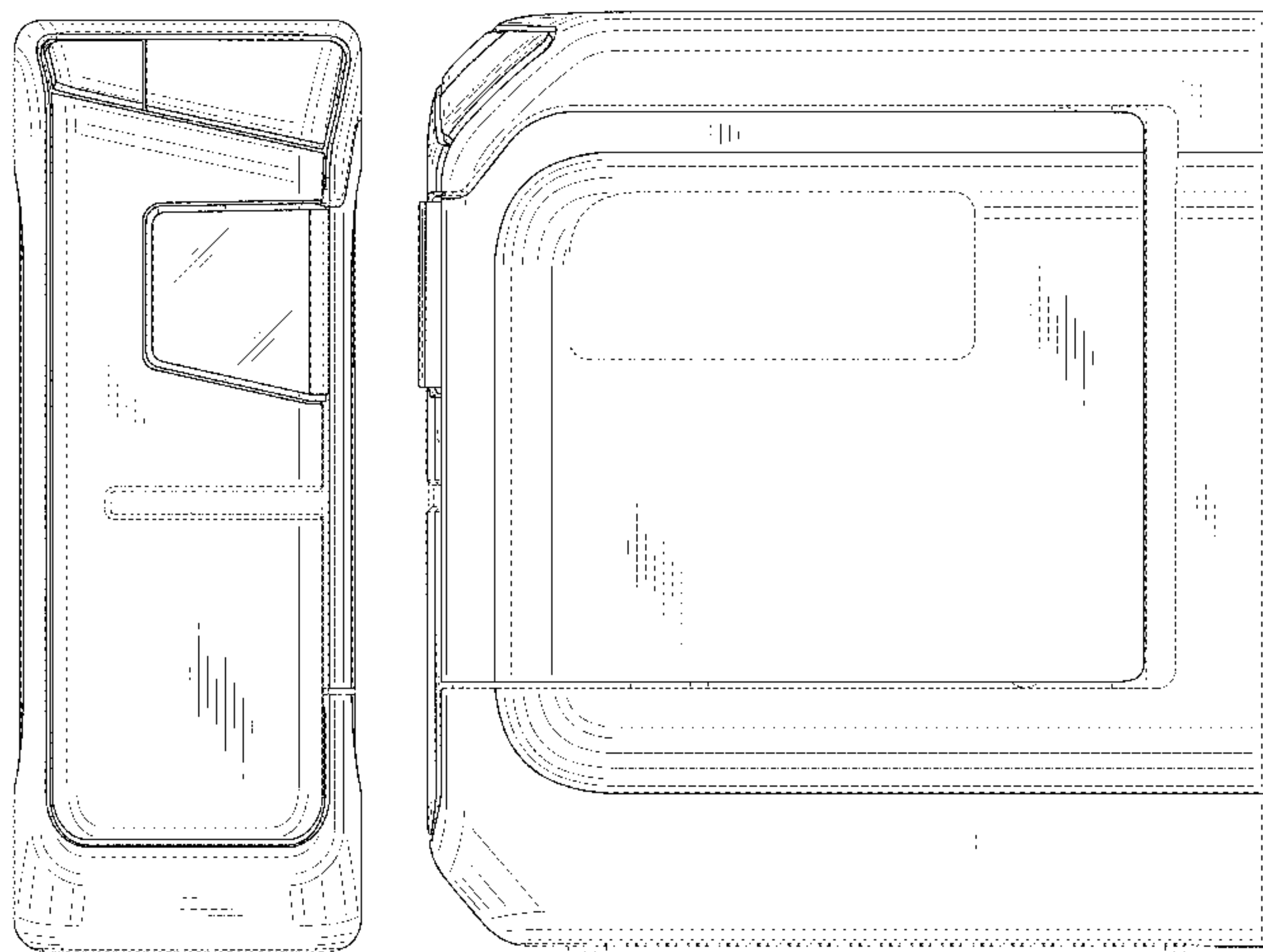

US D745,598 S

Page 2

(56)

References Cited

U.S. PATENT DOCUMENTS

D528,587 S * 9/2006 Nakaeda D18/19
D530,324 S * 10/2006 Sun et al. D14/349

D602,520 S * 10/2009 Kimura et al. D18/50
D641,394 S * 7/2011 Inada D18/50
D715,356 S * 10/2014 Nakagawa et al. D18/50

* cited by examiner

Fig. 1

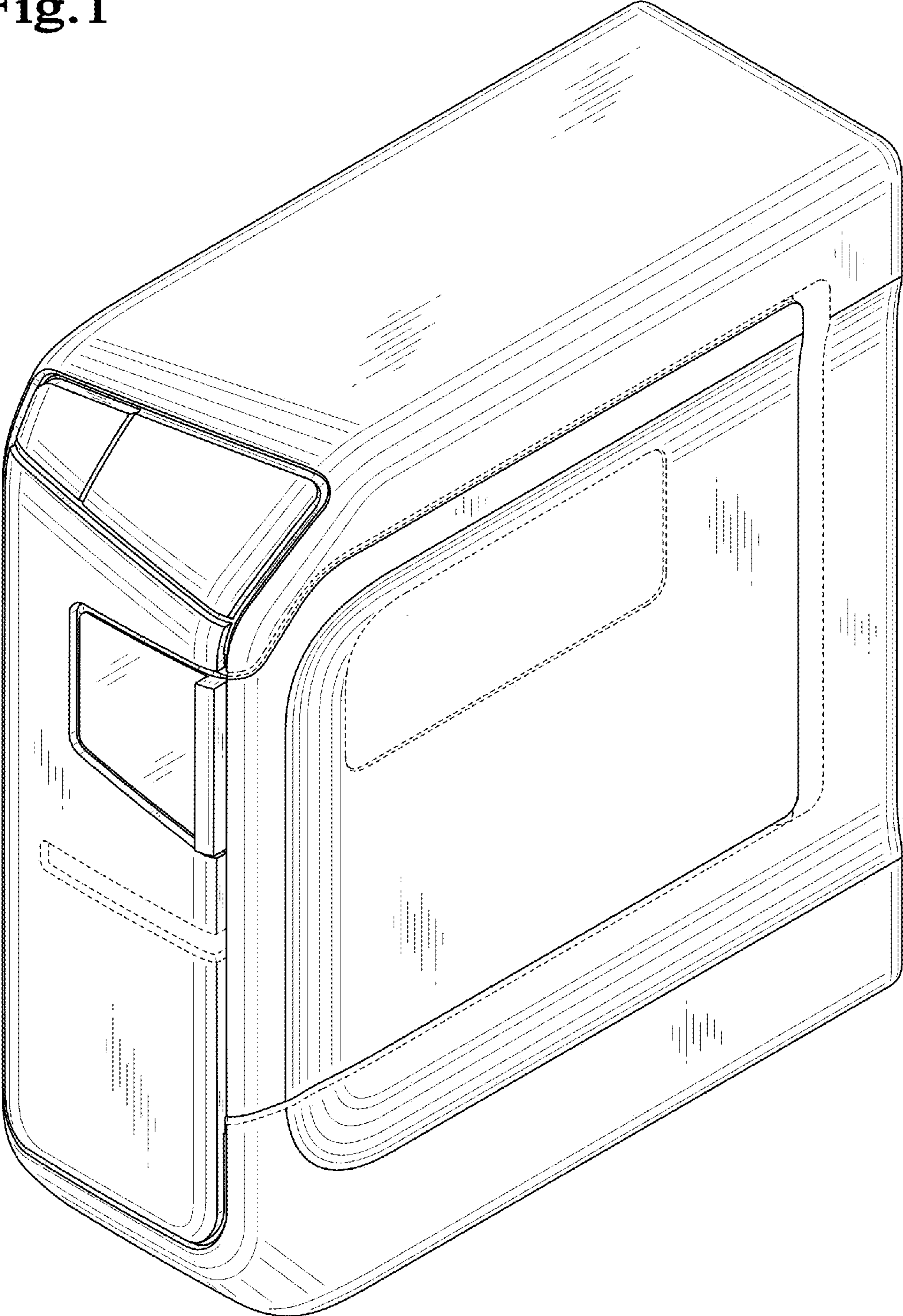

Fig.2

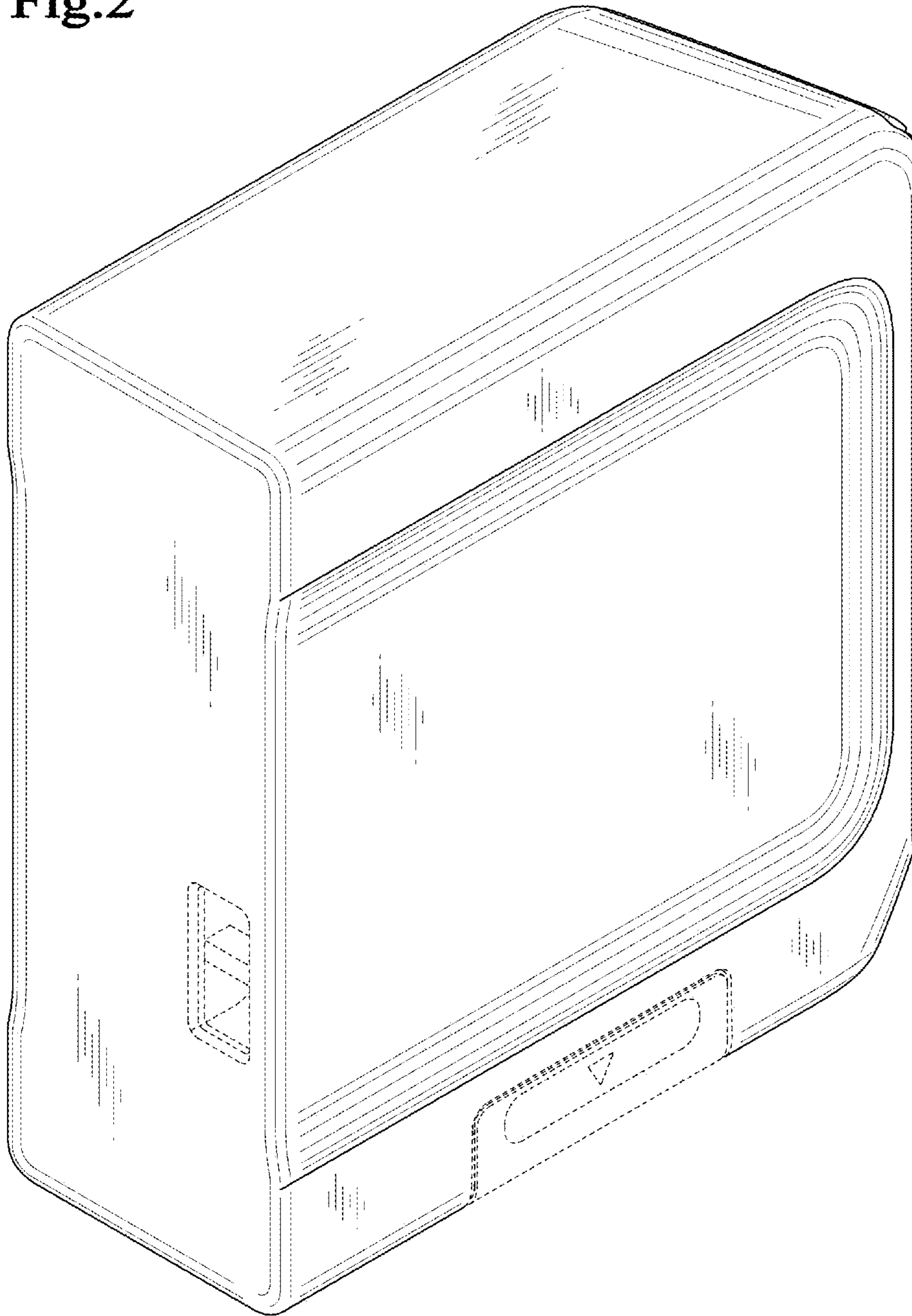

Fig.3

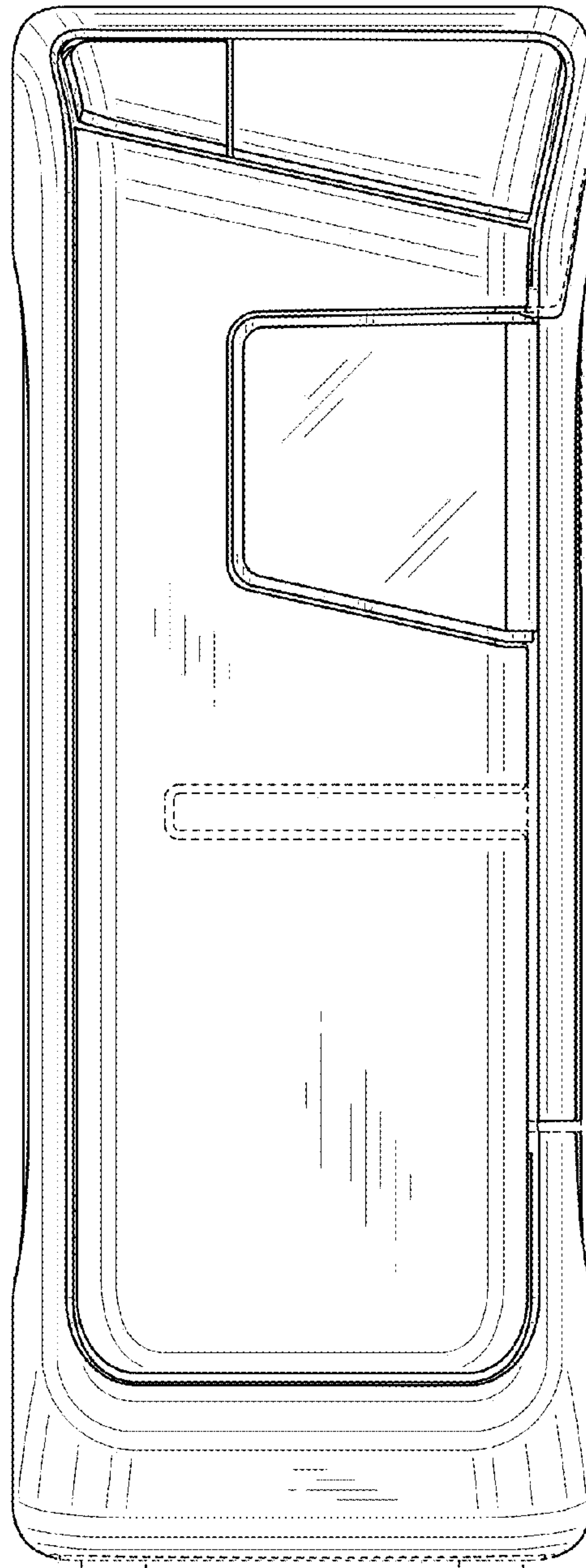

Fig.4

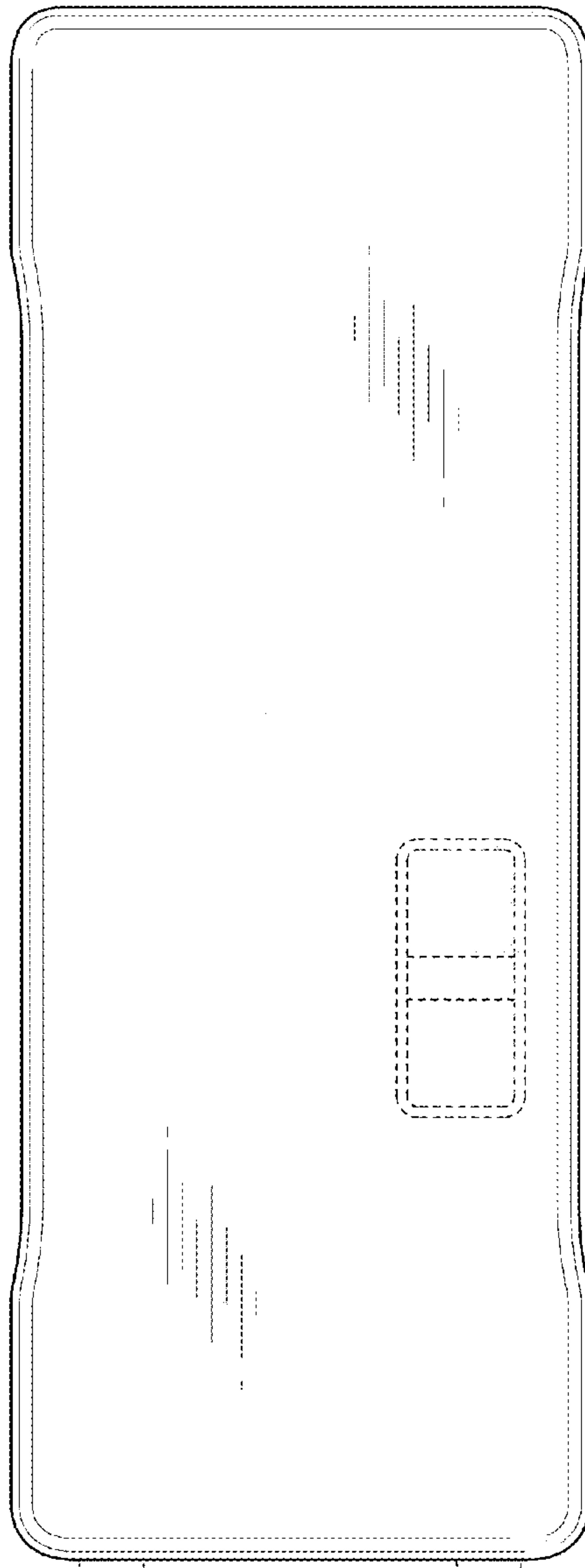

Fig.5

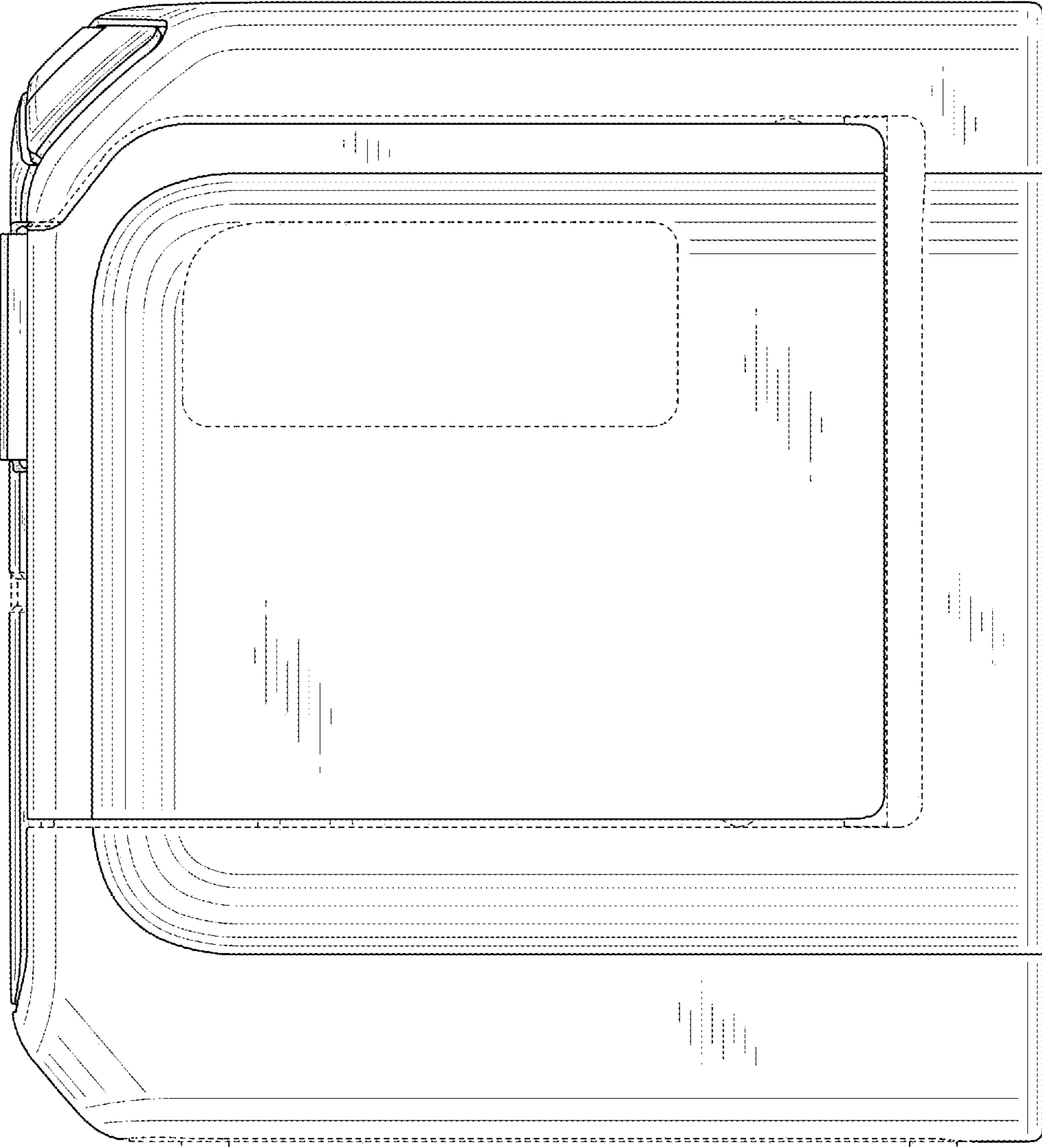

Fig.6

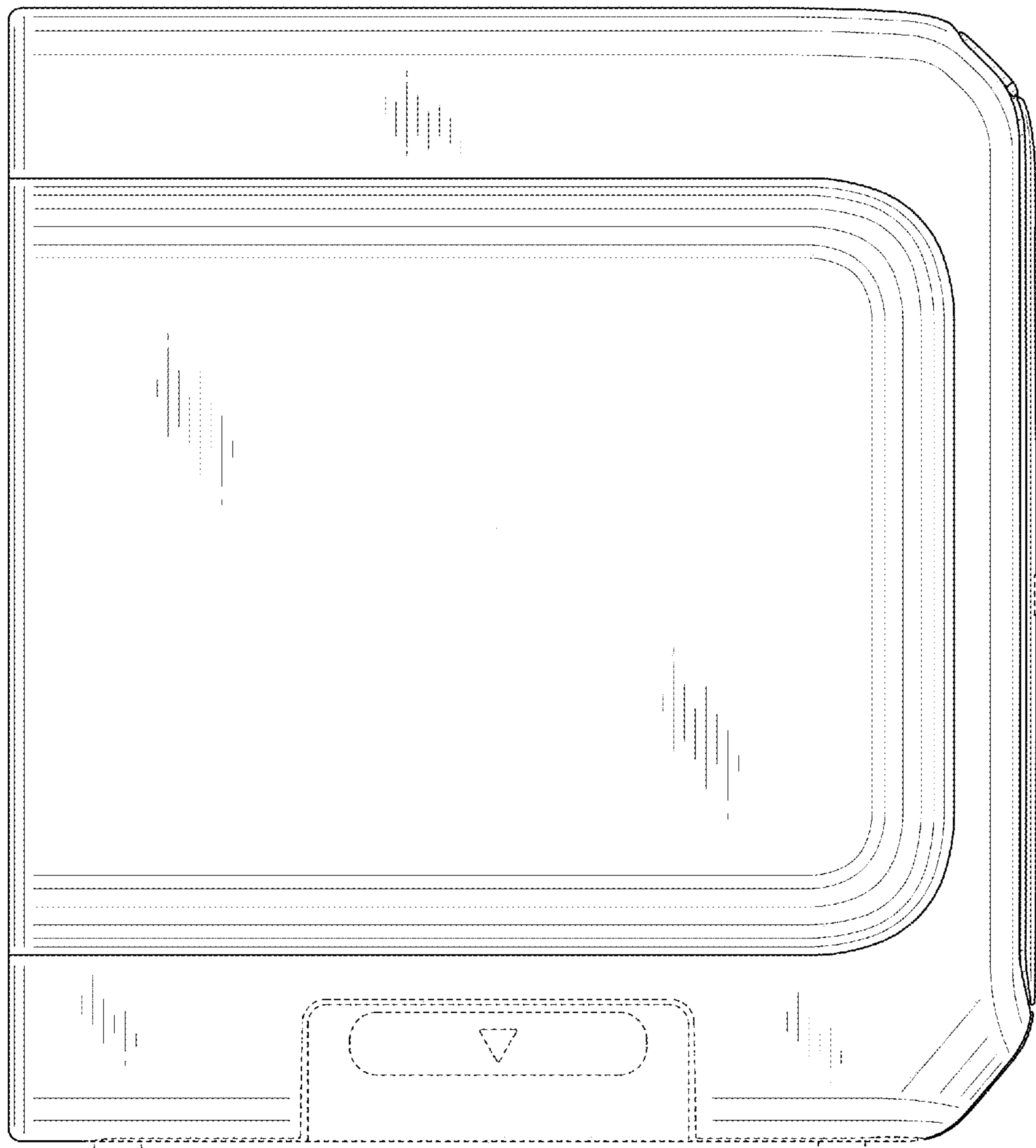

Fig. 7

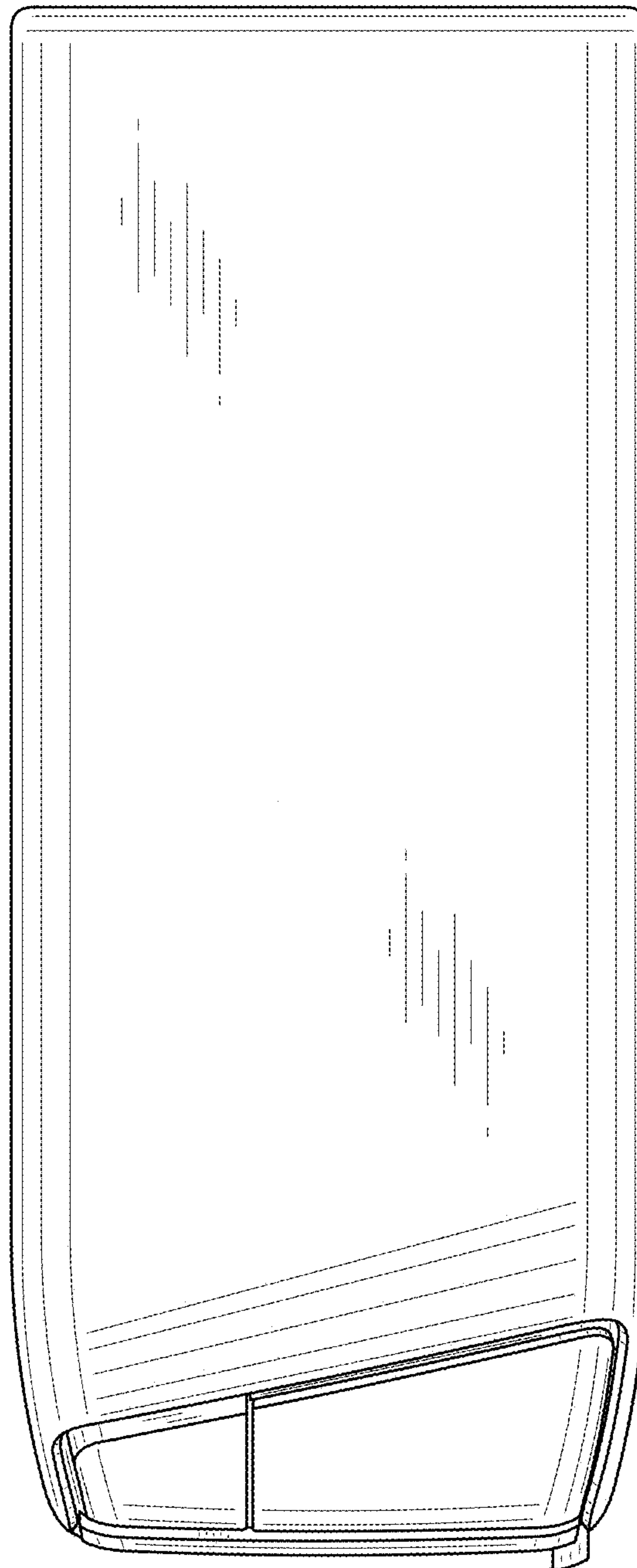
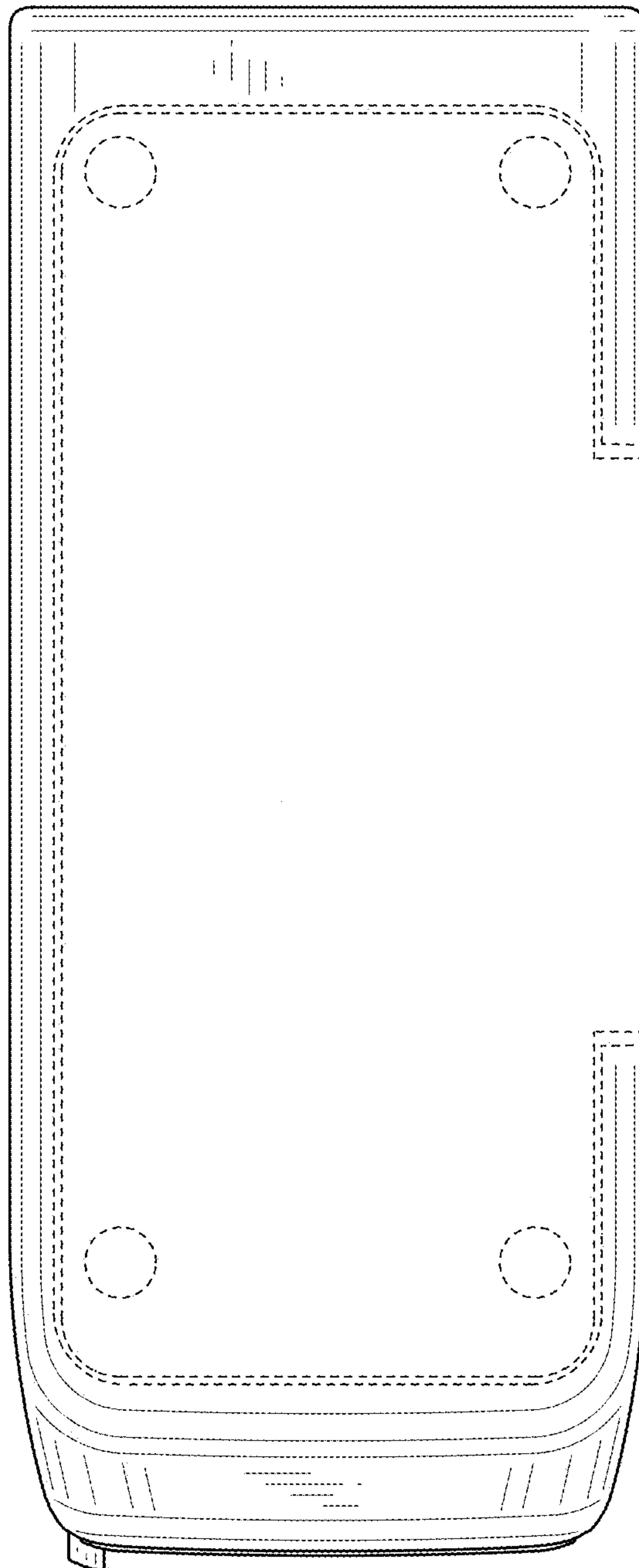

Fig. 8



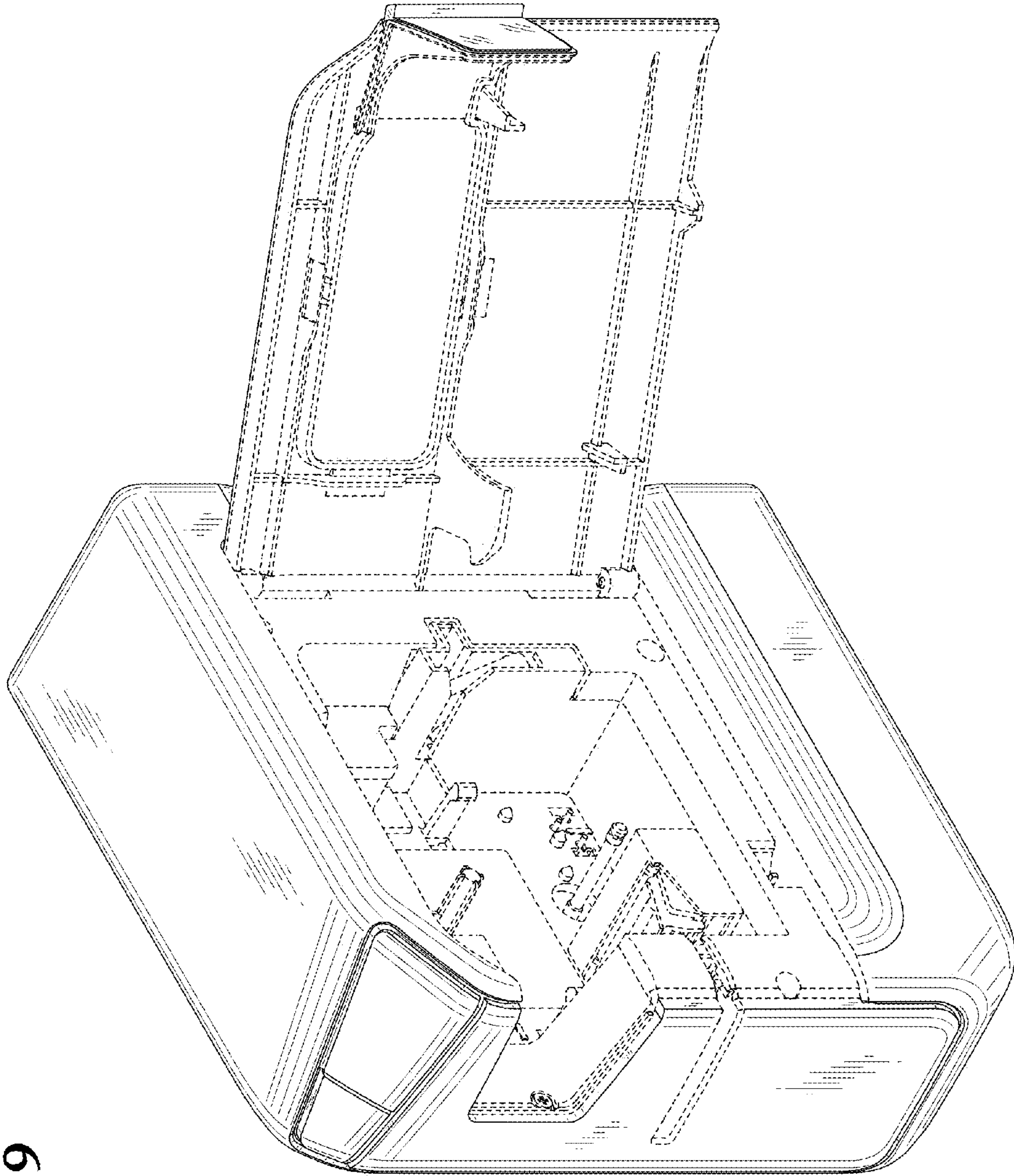

Fig.9