



US00D745482S

(12) **United States Design Patent**
Bang et al.

(10) **Patent No.:** **US D745,482 S**
(45) **Date of Patent:** **** Dec. 15, 2015**

(54) **TELEVISION RECEIVER**

(71) Applicant: **SAMSUNG ELECTRONICS CO., LTD.**, Suwon-si (KR)

(72) Inventors: **Sung-II Bang**, Seoul (KR); **Hae-Sung Park**, Seoul (KR)

(73) Assignee: **SAMSUNG ELECTRONICS CO., LTD.** (KR)

(**) Term: **14 Years**

(21) Appl. No.: **29/475,152**

(22) Filed: **Nov. 29, 2013**

(30) **Foreign Application Priority Data**

May 29, 2013 (KR) 30-2013-0027959

(51) **LOC (10) Cl.** **14-03**

(52) **U.S. Cl.**
USPC **D14/126**

(58) **Field of Classification Search**

USPC D14/125-134, 239, 371, 374-377, 450,
D14/448, 336, 159; D6/300, 310, 332;
D10/15, 26; D21/329, 515, 577, 333,
D21/331; D20/10; 312/7.2; 345/104, 156,
345/168, 87, 173, 690; 446/484, 175;
273/148 B; 248/917-924, 465;
348/836, 838, 180, 184, 325, 739
CPC H05K 5/0004; H05K 5/0017; H05K 5/02;
H05K 5/0217; G06F 1/1601; G06F 1/1643;
H04N 5/64; H04N 5/645; H04N 5/655
See application file for complete search history.

(56) **References Cited**

U.S. PATENT DOCUMENTS

D609,658 S * 2/2010 Kim et al. D14/126
D610,138 S * 2/2010 Andre et al. D14/336
D658,646 S * 5/2012 Akana et al. D14/336

D669,076 S * 10/2012 Haller D14/374
D673,947 S * 1/2013 Andre et al. D14/341
D711,377 S * 8/2014 Lam et al. D14/374
D712,406 S * 9/2014 Tseng et al. D14/374
D714,746 S * 10/2014 Euseok et al. D14/126
D716,244 S * 10/2014 Kim et al. D14/126
D718,731 S * 12/2014 Lee et al. D14/126
D719,158 S * 12/2014 Akana et al. D14/374
D721,679 S * 1/2015 Bang et al. D14/239
D722,579 S * 2/2015 Yagi D14/126
D722,987 S * 2/2015 Kim et al. D14/126
D722,988 S * 2/2015 Kim et al. D14/126
D723,482 S * 3/2015 Kim et al. D14/126
D723,487 S * 3/2015 Lee et al. D14/126

* cited by examiner

Primary Examiner — Eric Goodman
Assistant Examiner — Clese Moore, Jr.

(74) *Attorney, Agent, or Firm* — Cantor Colburn LLP

(57) **CLAIM**

We claim, the ornamental design for a television receiver, as shown and described.

DESCRIPTION

FIG. 1 is a front perspective view of a television receiver showing our new design;
FIG. 2 is a front elevation view of thereof;
FIG. 3 is a rear elevation view of thereof;
FIG. 4 is a side elevation view of thereof;
FIG. 5 is another side elevation view of thereof;
FIG. 6 is a top plan view of thereof;
FIG. 7 is a bottom plan view of thereof; and,
FIG. 8 is a rear perspective view thereof.
The broken lines illustrating portions of the television receiver are for environmental purpose only and form no part of the claimed design.
The shade lines in the figures show contour and not surface ornamentation.

1 Claim, 8 Drawing Sheets

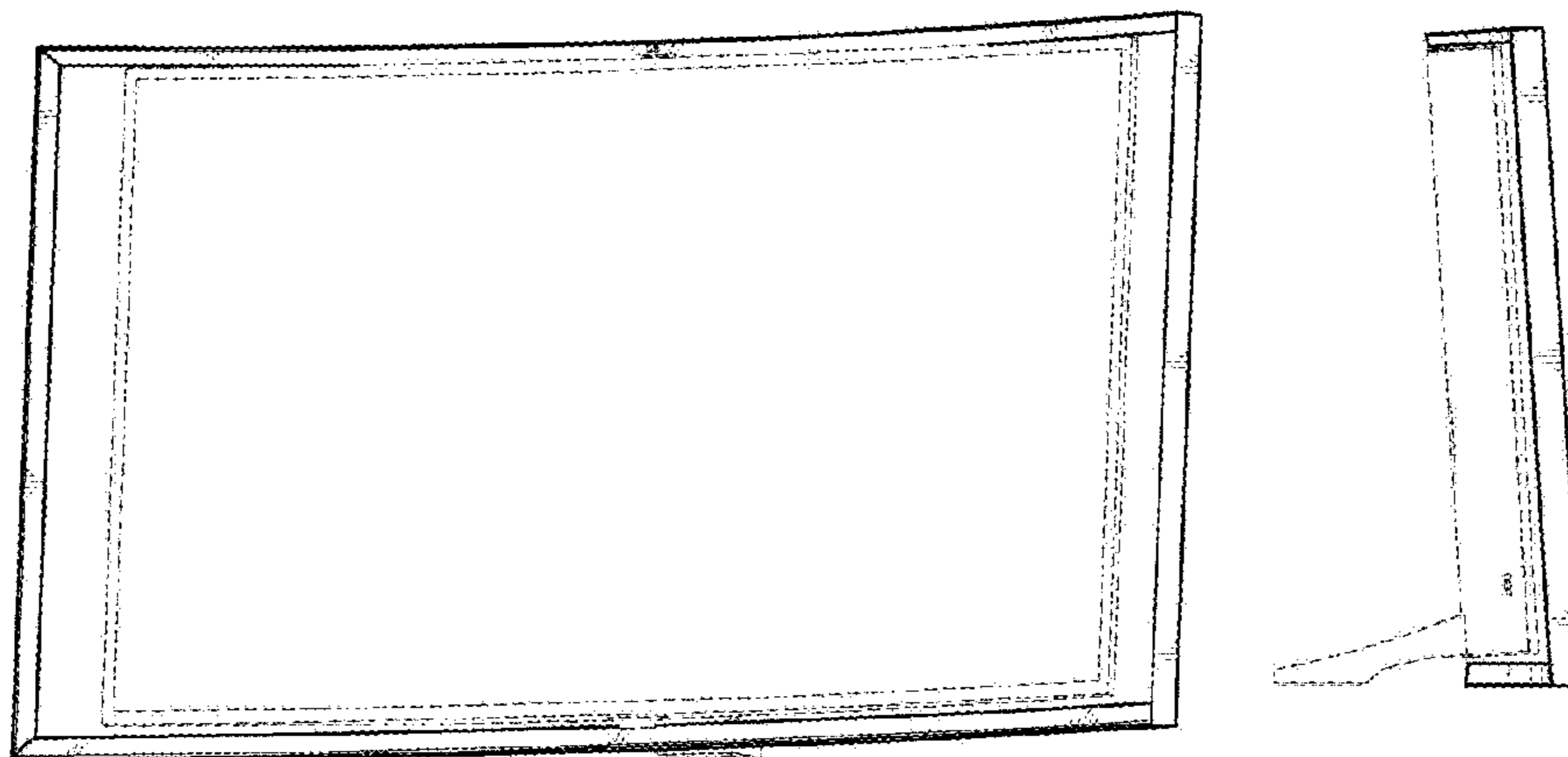

FIG. 1

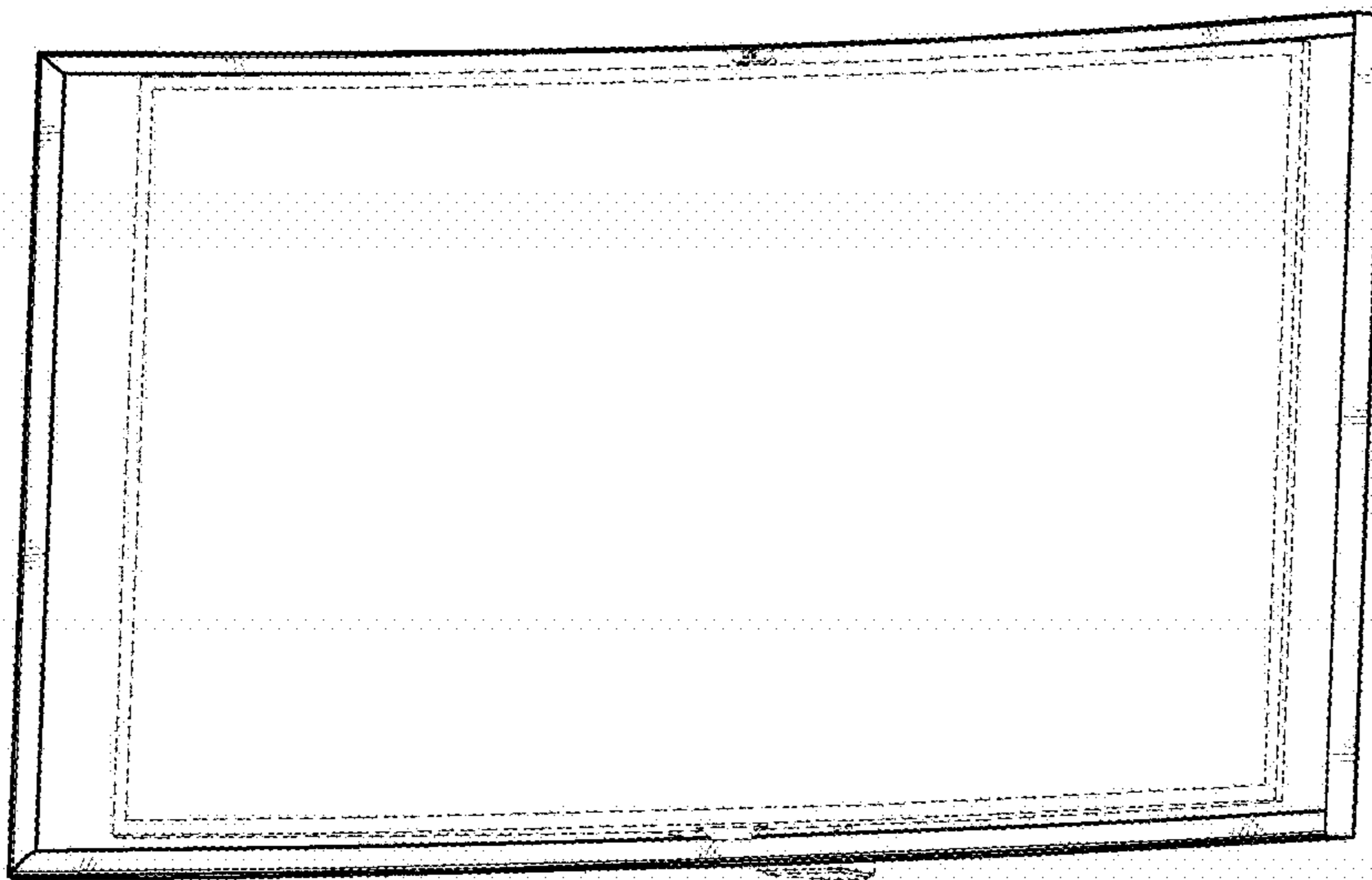

FIG. 2

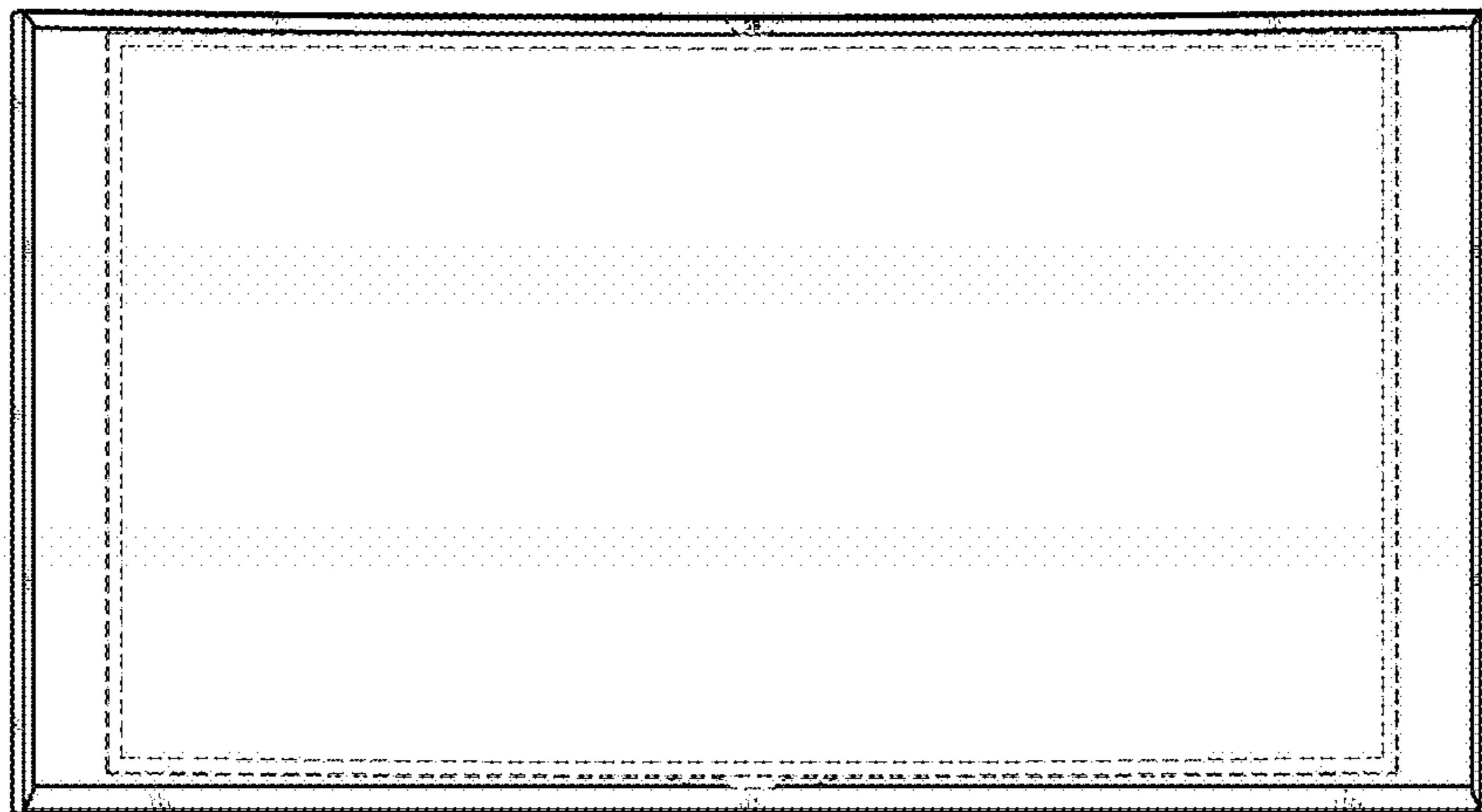

FIG. 3

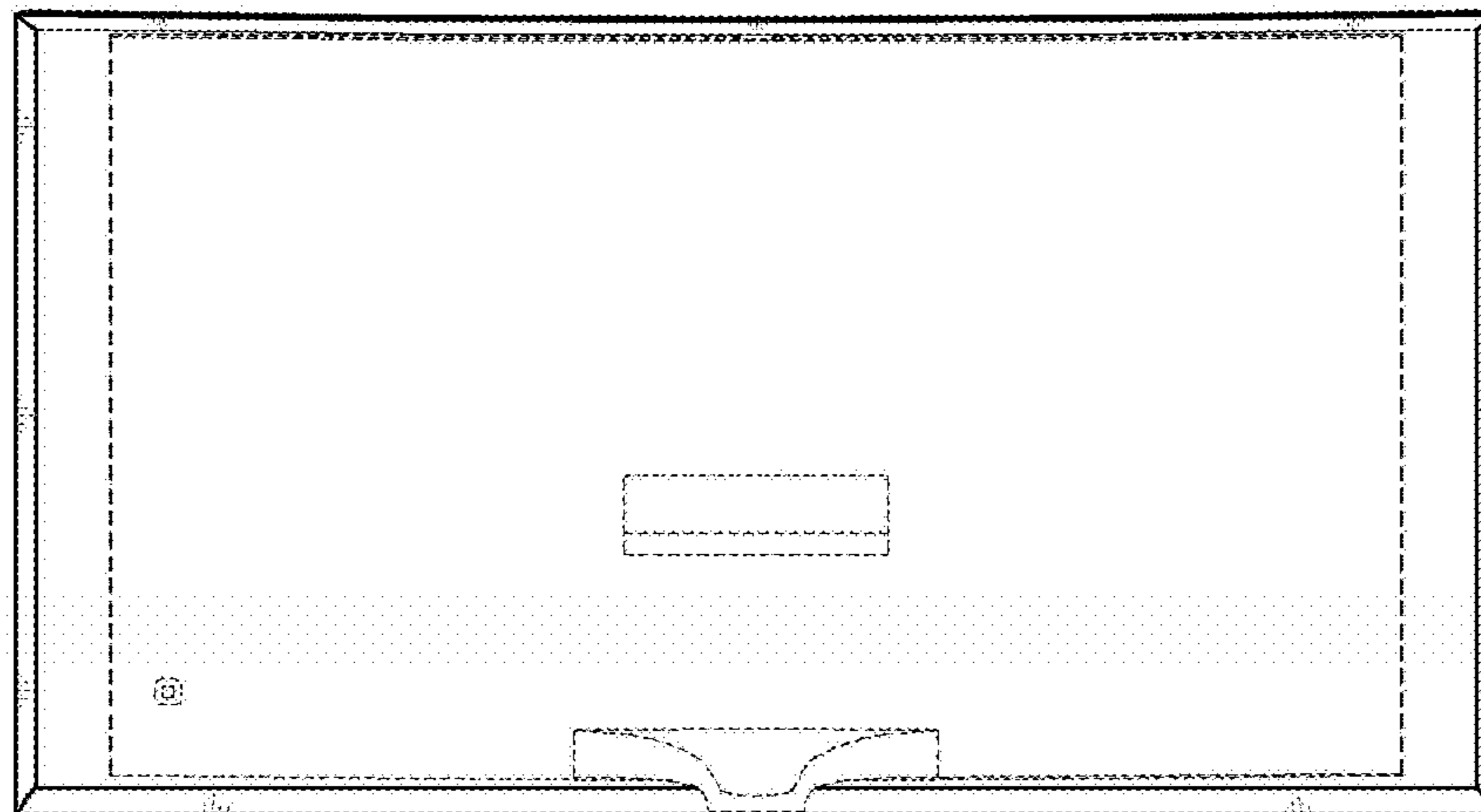

FIG. 4

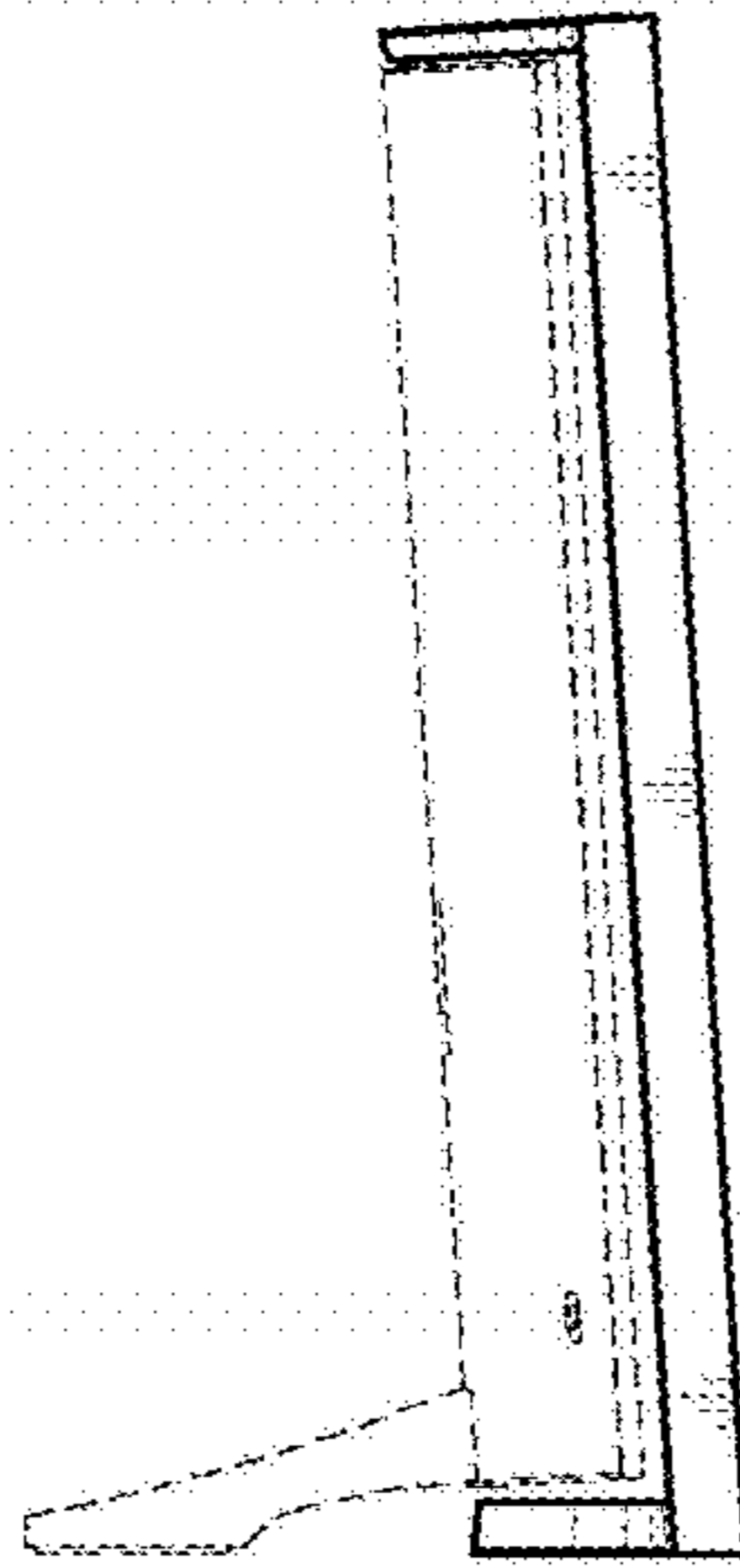

FIG. 5

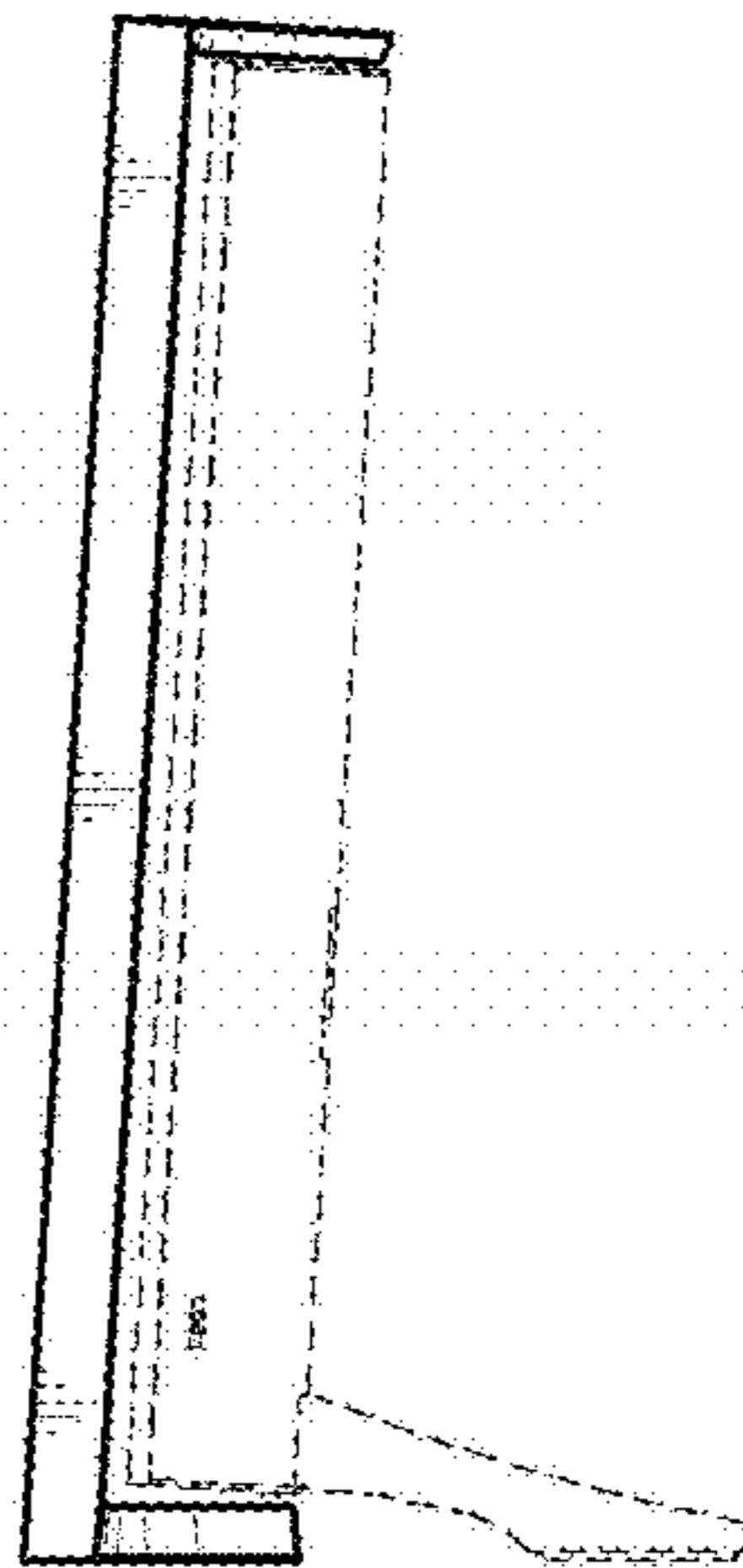

FIG. 6

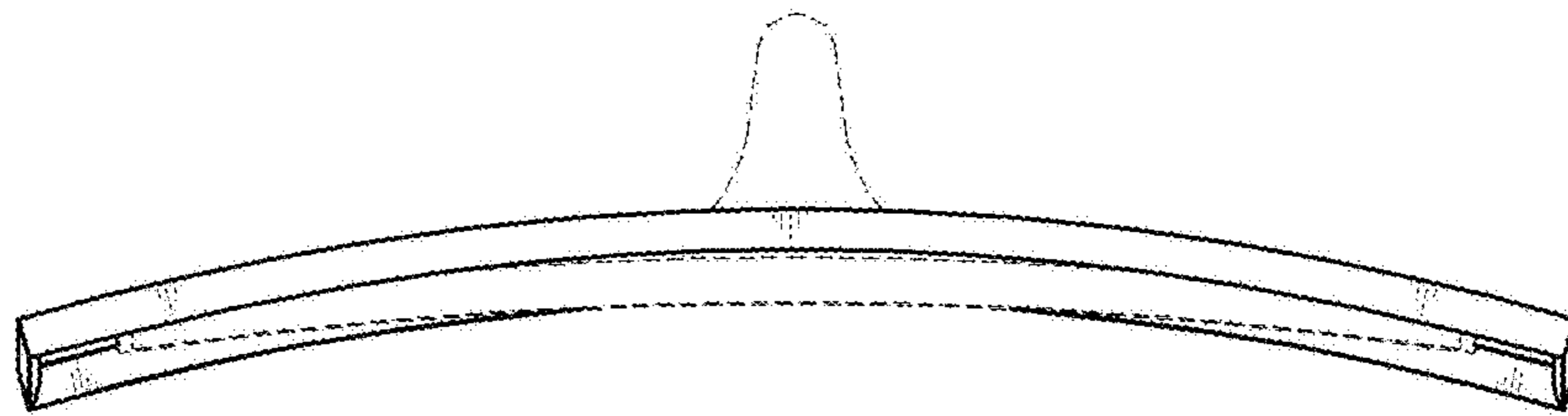

FIG. 7

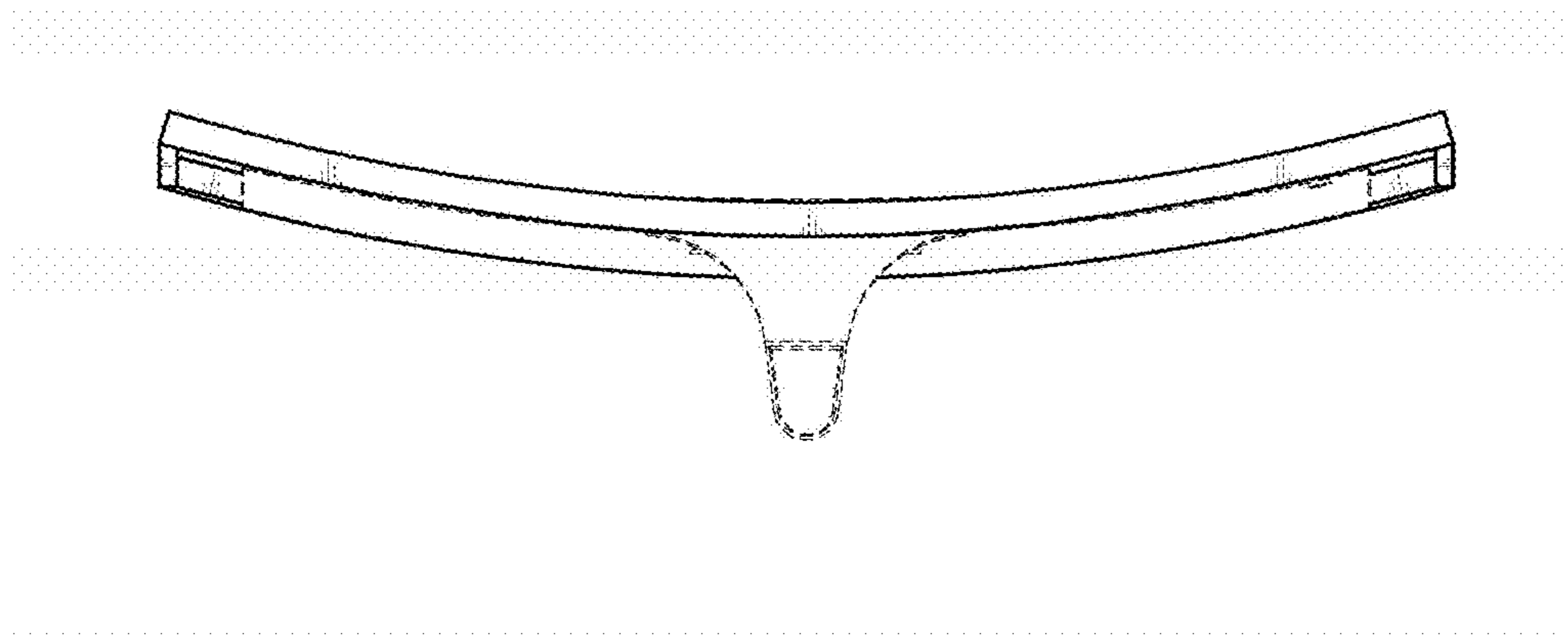

FIG. 8

