



US00D745468S

(12) **United States Design Patent**
Farnum et al.

(10) **Patent No.:** **US D745,468 S**
(45) **Date of Patent:** **** Dec. 15, 2015**

(54) **COVER PLATE FOR AN ELECTRICAL DEVICE**

(71) Applicant: **IDEAL INDUSTRIES, INC.**,
Sycamore, IL (US)
(72) Inventors: **Ron Farnum**, Lombard, IL (US); **John Olson**, Chicago, IL (US)
(73) Assignee: **IDEAL Industries, Inc.**, Sycamore, IL (US)
(**) Term: **14 Years**

(21) Appl. No.: **29/469,862**
(22) Filed: **Oct. 15, 2013**
(51) **LOC (10) Cl.** **13-03**
(52) **U.S. Cl.**
USPC **D13/156**
(58) **Field of Classification Search**
USPC D13/154–156, 107, 184, 199; D8/349,
D8/350, 351, 353; D14/432, 217
CPC H02G 1/08; H02G 1/14; H02G 3/00;
H02G 3/04; H02G 3/0148; H02G 3/08;
H02G 3/081; H02G 3/083; H02G 3/10;
H02G 3/12; H02G 3/18; H02G 3/185; H02G
15/10; H02G 15/085; H01R 3/00; H01R
11/16; H01R 13/18; H01R 25/06; H01H 1/38;
H01H 1/5866; H01H 27/00
See application file for complete search history.

(56) **References Cited**

U.S. PATENT DOCUMENTS

D419,978 S * 2/2000 Mah D14/432
D588,540 S * 3/2009 Barnes et al. D13/139.1
D595,238 S * 6/2009 Vigorito et al. D13/156
D628,044 S * 11/2010 Schutte D8/353
D719,525 S * 12/2014 DeCosta D13/155

* cited by examiner

Primary Examiner — Daniel Bui
Assistant Examiner — Khawaja Anwar
(74) *Attorney, Agent, or Firm* — Greenberg Traurig, LLP

(57) **CLAIM**

What is claimed is the ornamental design for a cover plate for an electrical device, as shown and described.

DESCRIPTION

FIG. 1 is a perspective view of a cover plate for an electrical device showing our new design;
FIG. 2 is a top plan view thereof;
FIG. 3 is a bottom plan view thereof;
FIG. 4 is a left side elevational view thereof;
FIG. 5 is a right side elevational view thereof;
FIG. 6 is a rear side elevational view thereof; and,
FIG. 7 is a front side elevational view thereof
The broken lines in the figure drawings show unclaimed environment only and form no part of the claimed design.

1 Claim, 4 Drawing Sheets

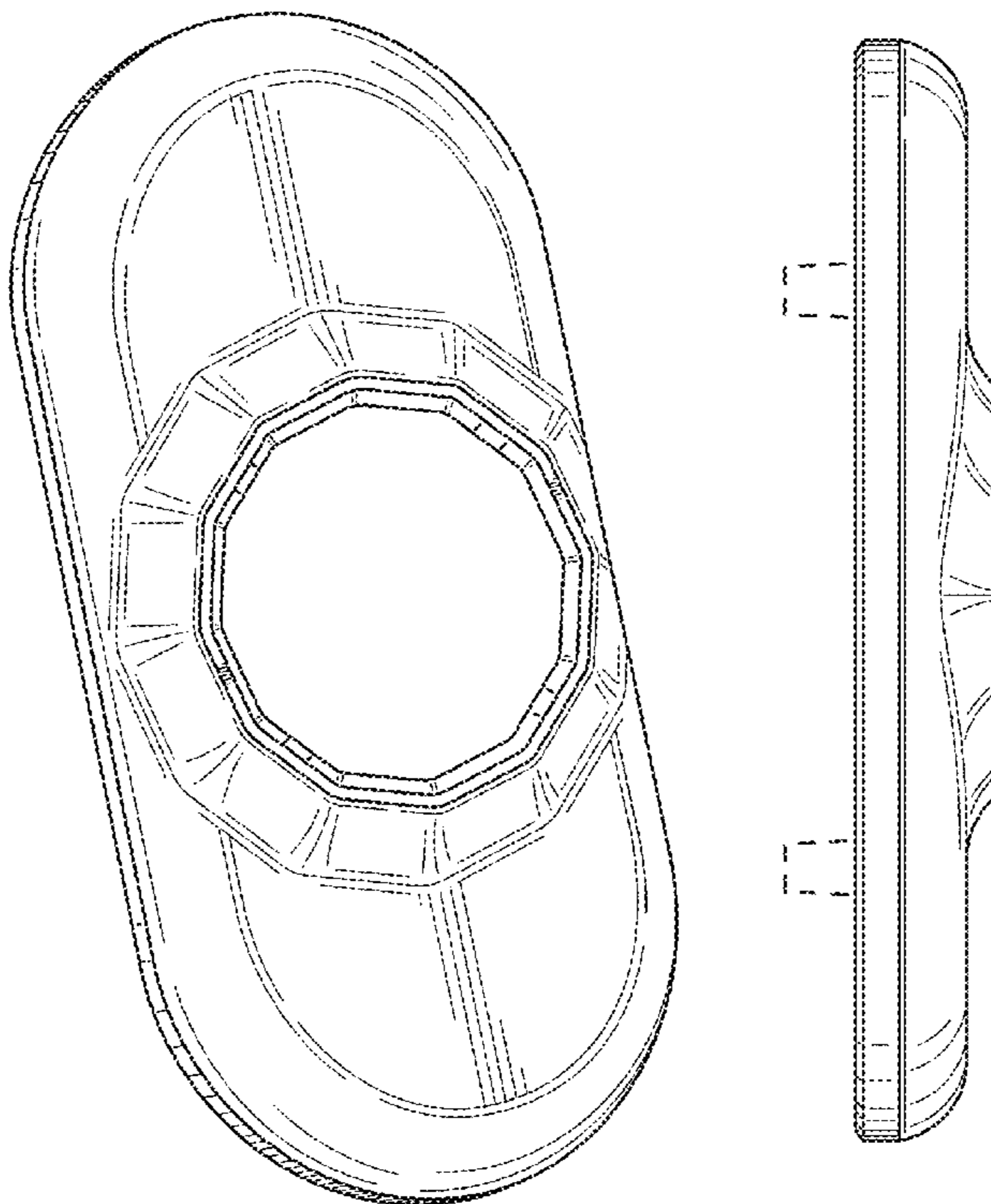

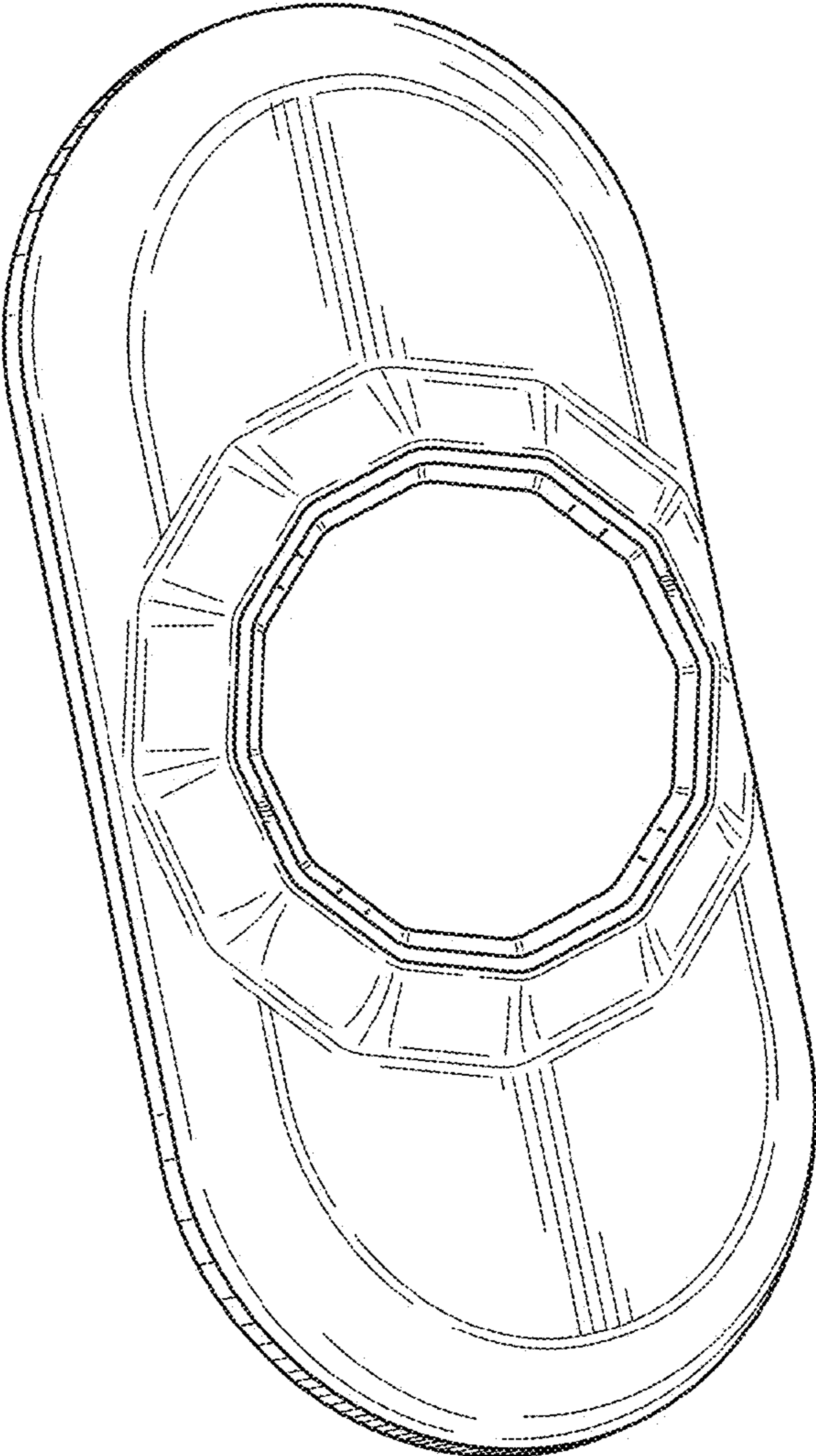

FIG. 1

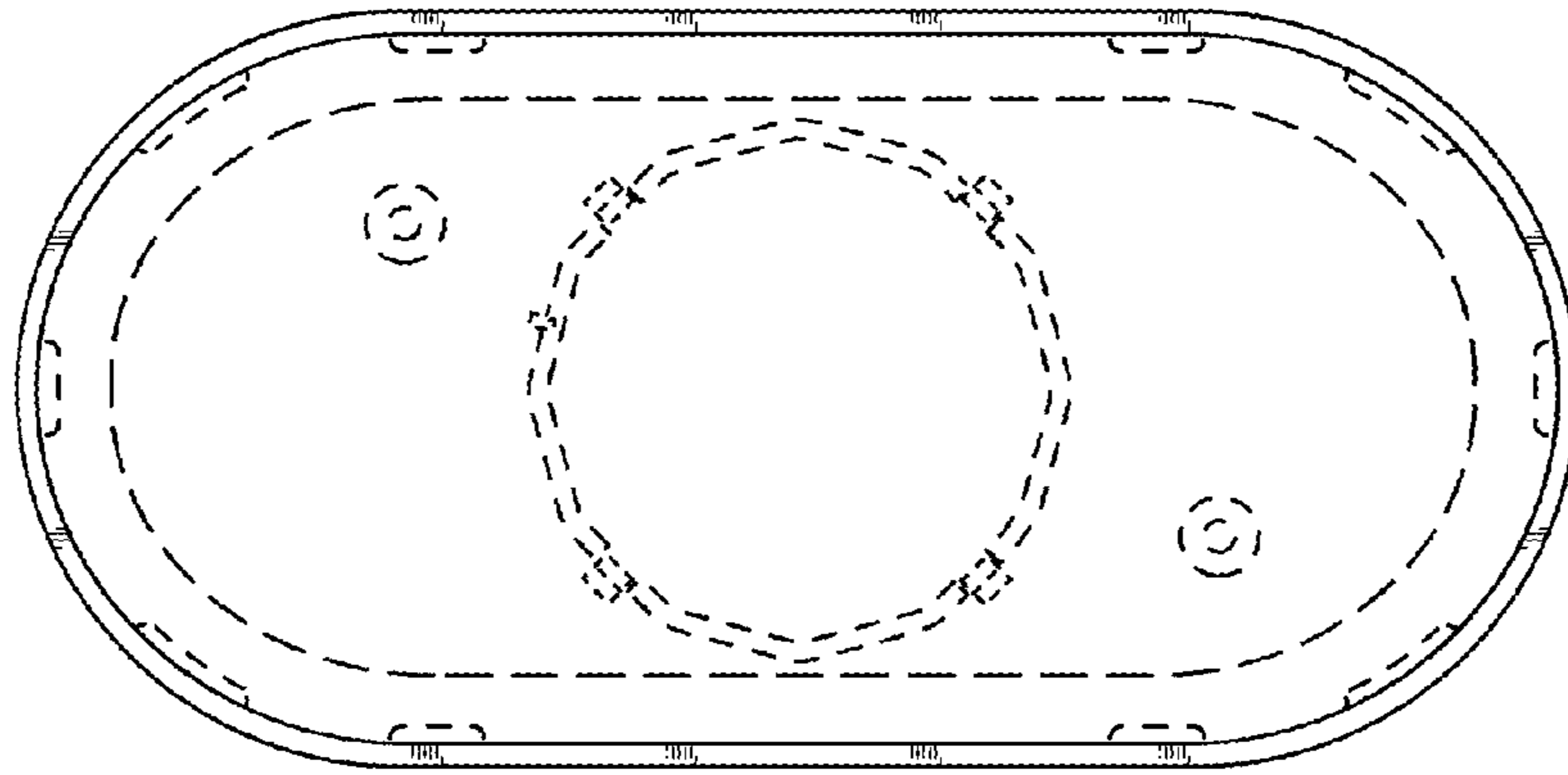

FIG. 3

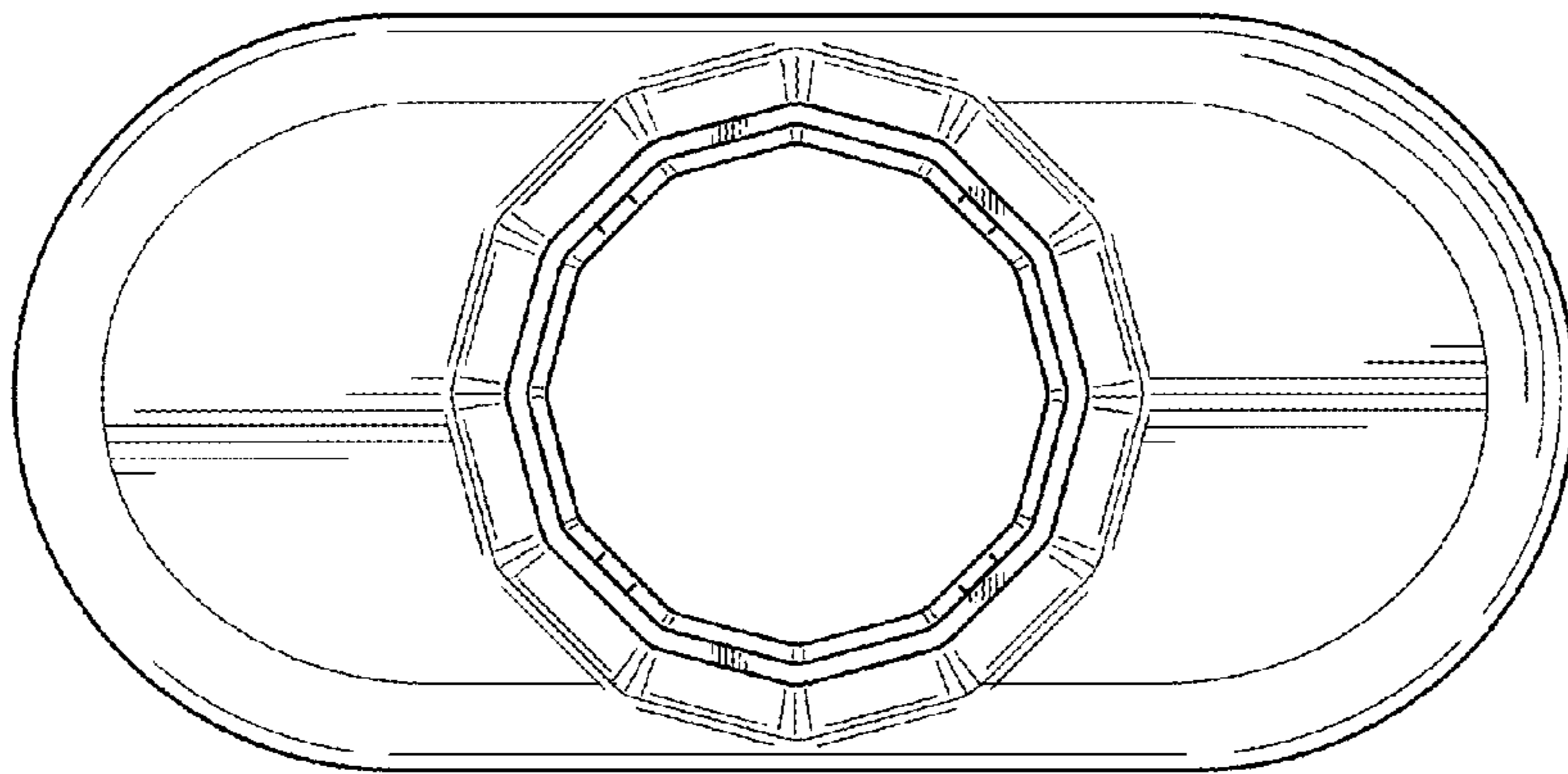

FIG. 2

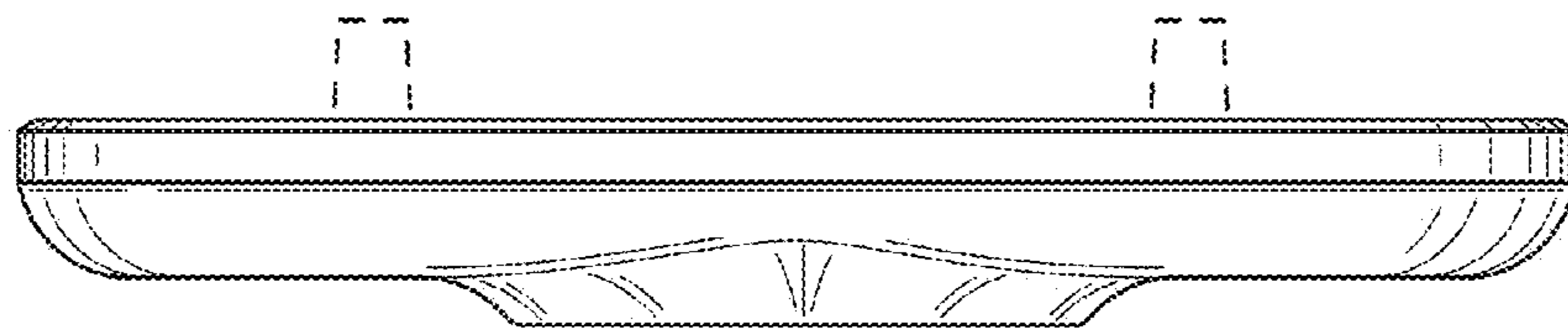

FIG. 5

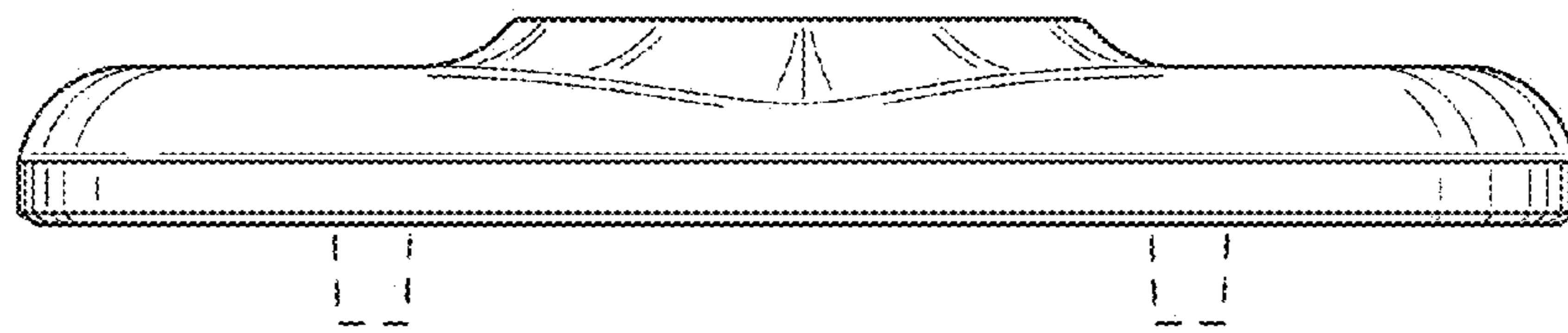

FIG. 4

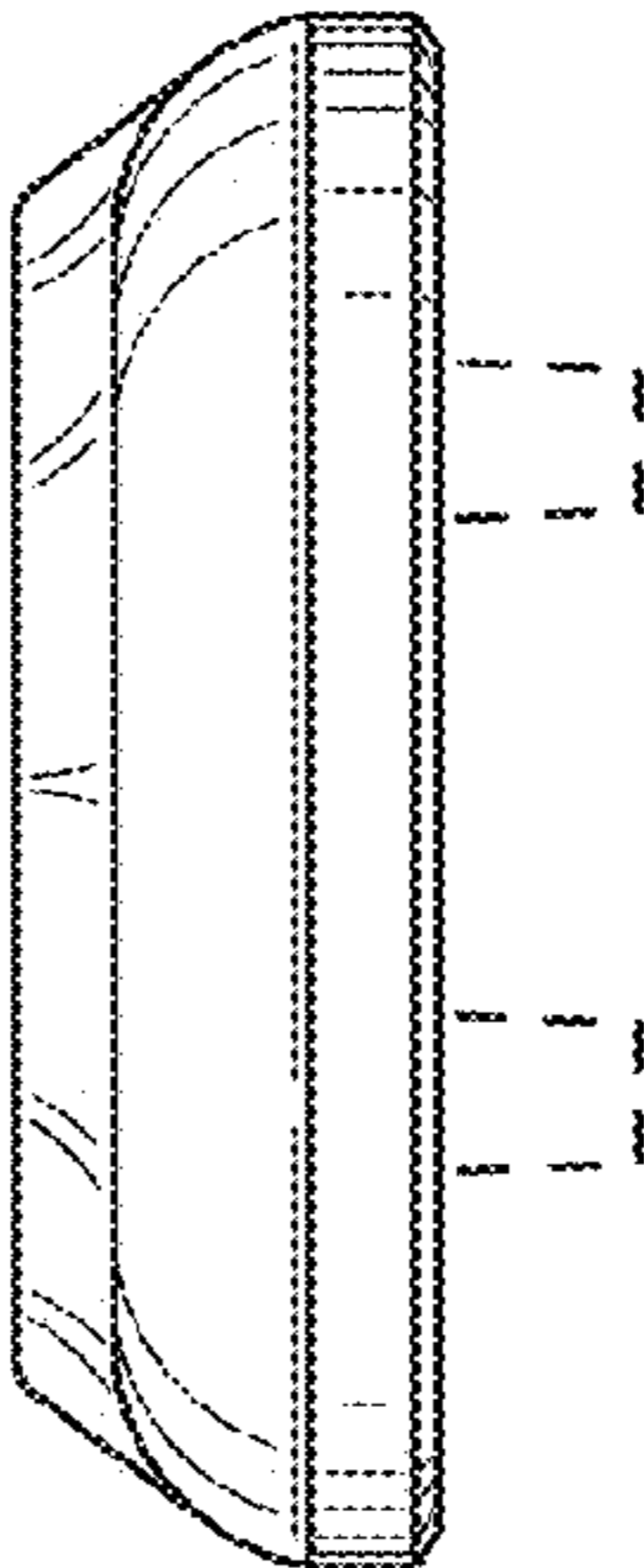

FIG. 6

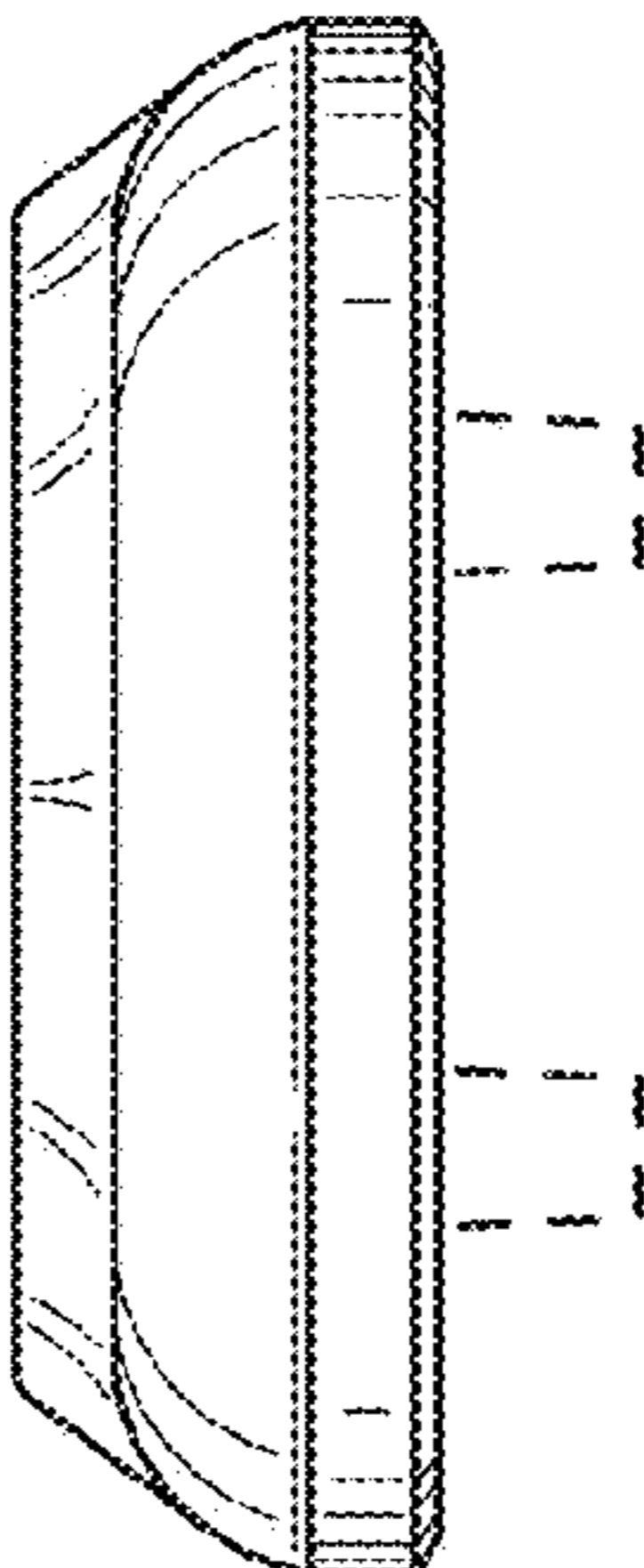

FIG. 7