



US00D745455S

(12) **United States Design Patent**
Nook et al.

(10) **Patent No.:** **US D745,455 S**
(45) **Date of Patent:** **** Dec. 15, 2015**

(54) **BATTERY BOOSTER**

(71) Applicant: **THE NOCO COMPANY**, Glenwillow, OH (US)

(72) Inventors: **Jonathan Lewis Nook**, Gates Mills, OH (US); **William Knight Nook, Sr.**, Shaker Heights, OH (US); **James Richard Stanfield**, Peoria, AZ (US); **Derek Michael Underhill**, Tempe, AZ (US)

(73) Assignee: **THE NOCO COMPANY**, Glenwillow, OH (US)

(**) Term: **14 Years**

(21) Appl. No.: **29/496,700**

(22) Filed: **Jul. 16, 2014**

(51) **LOC (10) Cl.** **13-02**

(52) **U.S. Cl.**

USPC **D13/107**; D13/103

(58) **Field of Classification Search**

USPC D13/102-106, 110, 118-119, 184, D13/107-108; D14/96-100, 163, 176

CPC Y02E 60/12; Y02E 60/122; Y02E 60/124; Y02E 60/50; H01M 2/02; H01M 2/022;

H01M 2/0202; H01M 2/0207; H01M 2/0212;

H01M 2/1061; H01M 2/1022; H01M 2/1055;

H01M 2/1066; H01M 2/105; H01M 2/204;

H01M 10/4257; H01M 10/0436; H01M 10/48;

H01M 10/44; H01M 10/46; H01M 10/465;

H01M 10/482; H01M 2200/30; H01M

2250/30; H01M 2250/40; H02J 7/00; H02J

7/0003; H02J 7/0011; H02J 7/0013; H02J

7/0054; H02J 7/0055; H02J 7/0057; H02J

2007/0062

See application file for complete search history.

(56) **References Cited**

U.S. PATENT DOCUMENTS

5,019,767	A *	5/1991	Shirai et al.	320/112
D485,810	S *	1/2004	Fiocchi	D13/184
D634,313	S *	3/2011	Fitzpatrick et al.	D14/250
D654,854	S *	2/2012	Inskeep	D13/107
D664,501	S *	7/2012	Inskeep	D13/107
D681,550	S *	5/2013	Corbin	D13/103
D687,768	S *	8/2013	Minamikawa	D13/107
D694,176	S *	11/2013	Buetow et al.	D13/103
D694,180	S *	11/2013	Inskeep	D13/107
D701,490	S *	3/2014	Inskeep	D13/110
2006/0201558	A1 *	9/2006	Marty et al.	137/613
2008/0213653	A1 *	9/2008	Marukawa et al.	429/72
2011/0116861	A1 *	5/2011	Zhang et al.	403/322.1
2013/0164600	A1 *	6/2013	Roskamp et al.	429/159
2014/0184898	A1 *	7/2014	Overliese et al.	348/372
2015/0099151	A1 *	4/2015	Lavender	429/121

OTHER PUBLICATIONS

U.S. Trademark Application No. 86030590 filed on Aug. 6, 2013, including drawing and sample.

* cited by examiner

Primary Examiner — Rosemary K Tarcza

Assistant Examiner — Sanjeev Paul

(74) *Attorney, Agent, or Firm* — Vorys, Sater, Seymour and Pease LLP; William L. Klima

(57) **CLAIM**

The ornamental design for a battery booster, as shown and described.

DESCRIPTION

FIG. 1 is a top perspective view for a battery booster;

FIG. 2 is a bottom perspective view thereof;

FIG. 3 is a bottom planar view thereof; and

FIG. 4 is a top planar view thereof.

FIG. 5 is a left-side elevational view thereof;

FIG. 6 is a right-side elevational view thereof;

FIG. 7 is a front-side elevational view thereof; and,

FIG. 8 is a rear-side elevational view thereof.

1 Claim, 6 Drawing Sheets

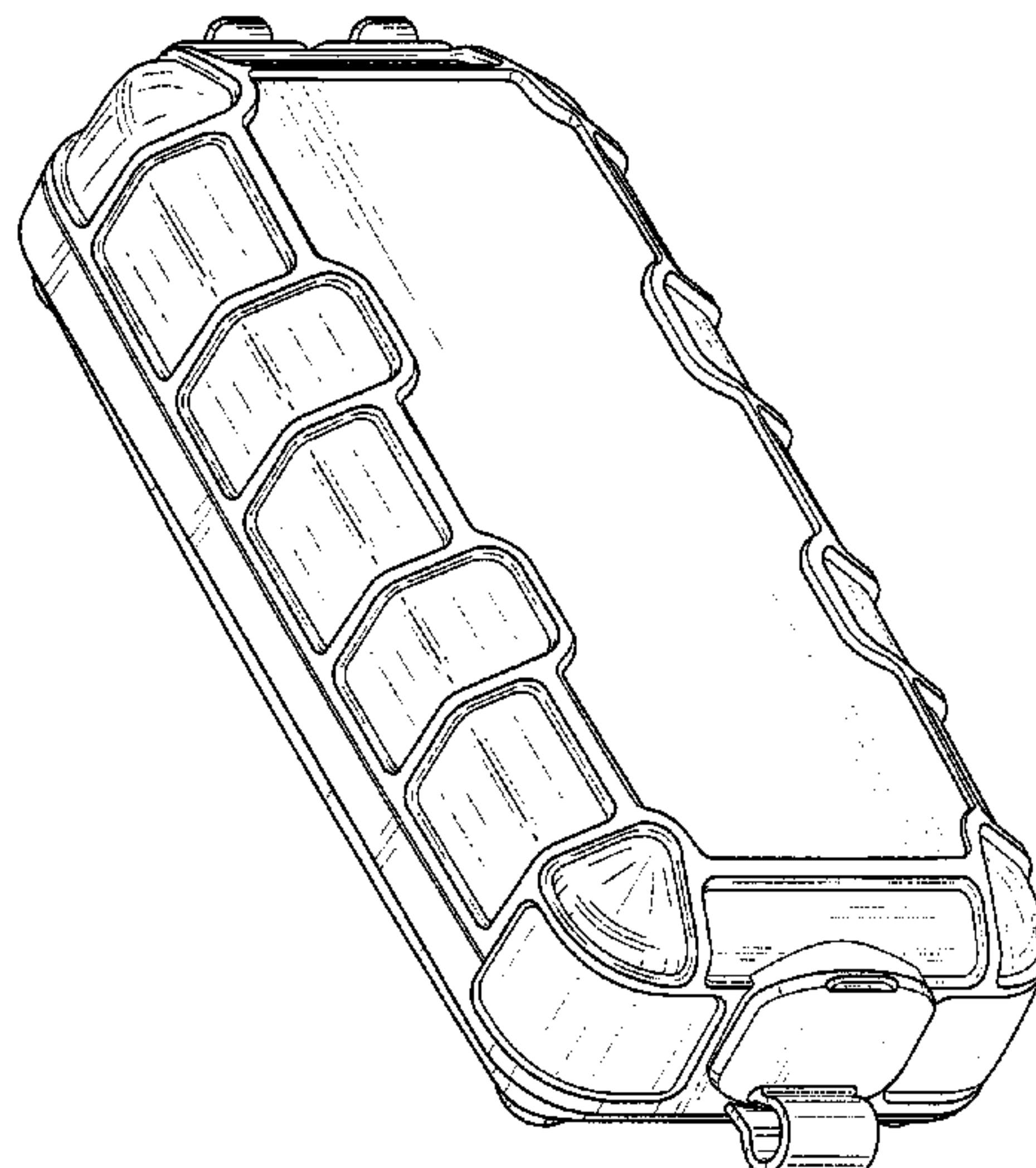

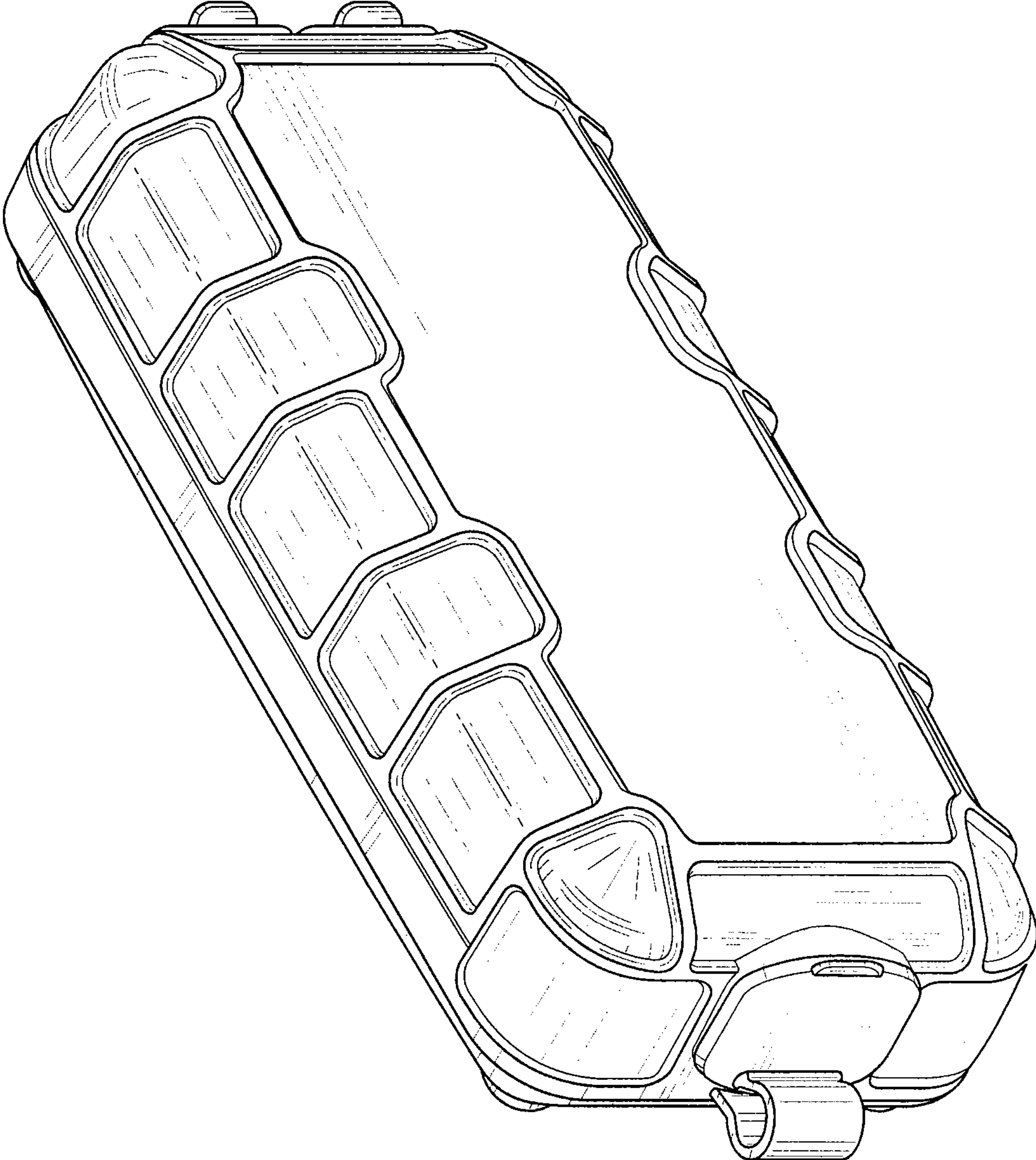

FIG. 1

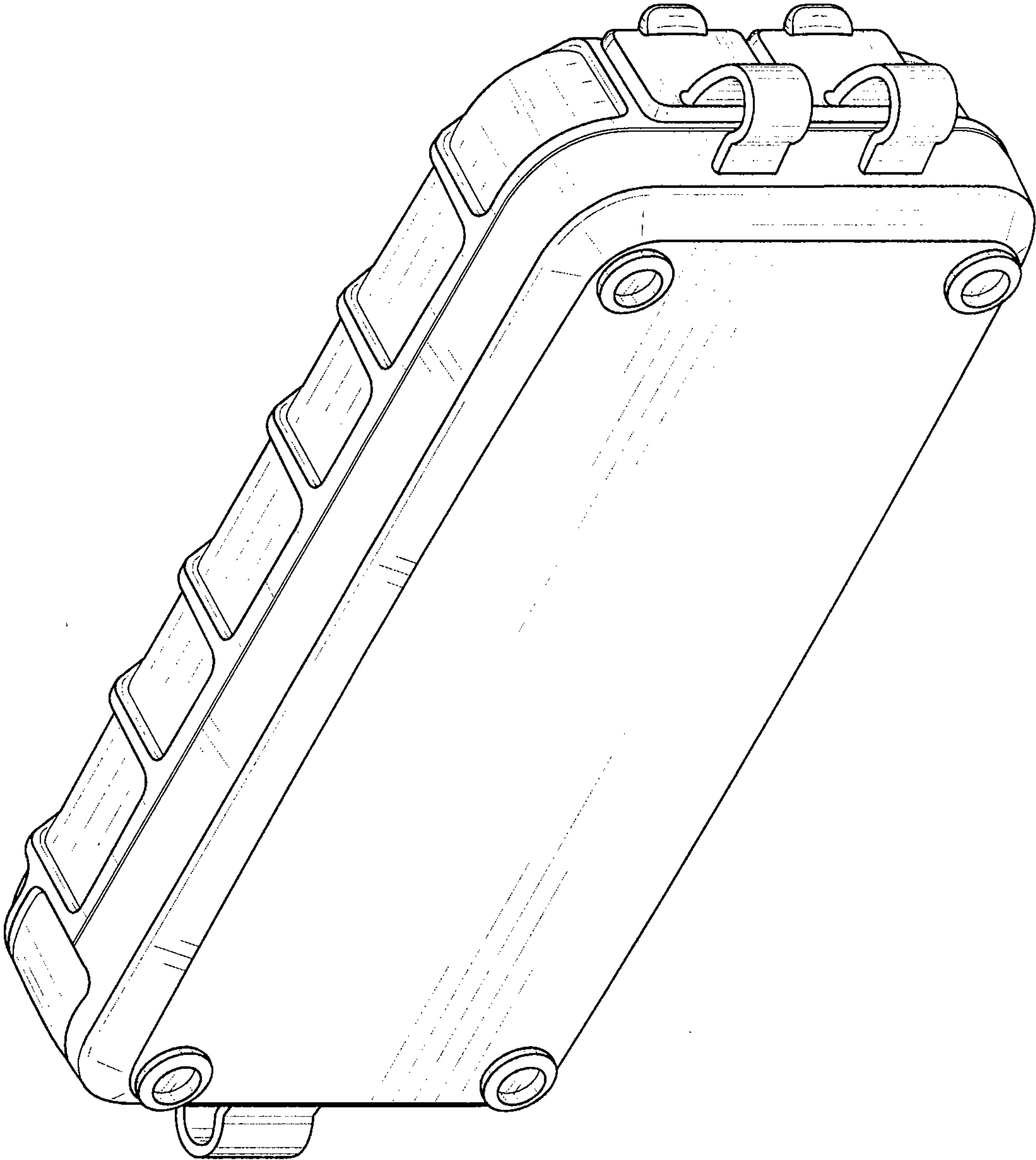

FIG. 2

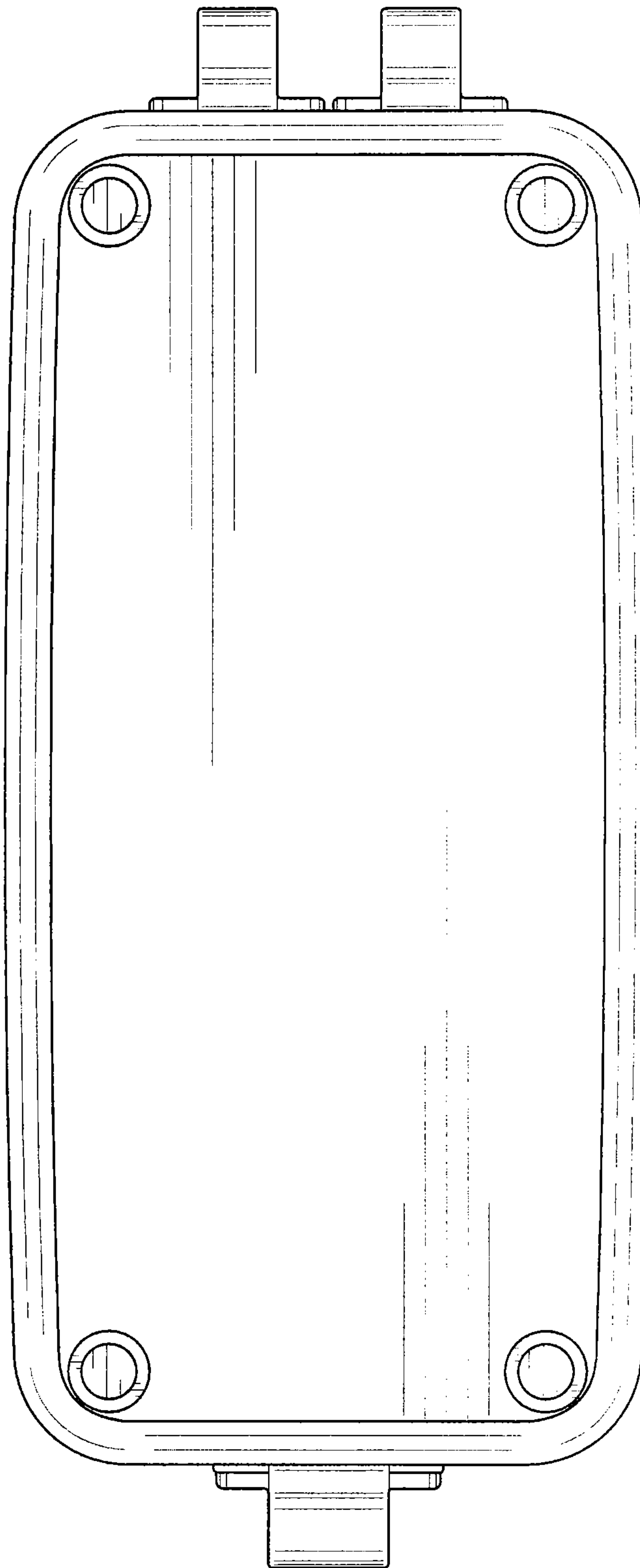

FIG. 3

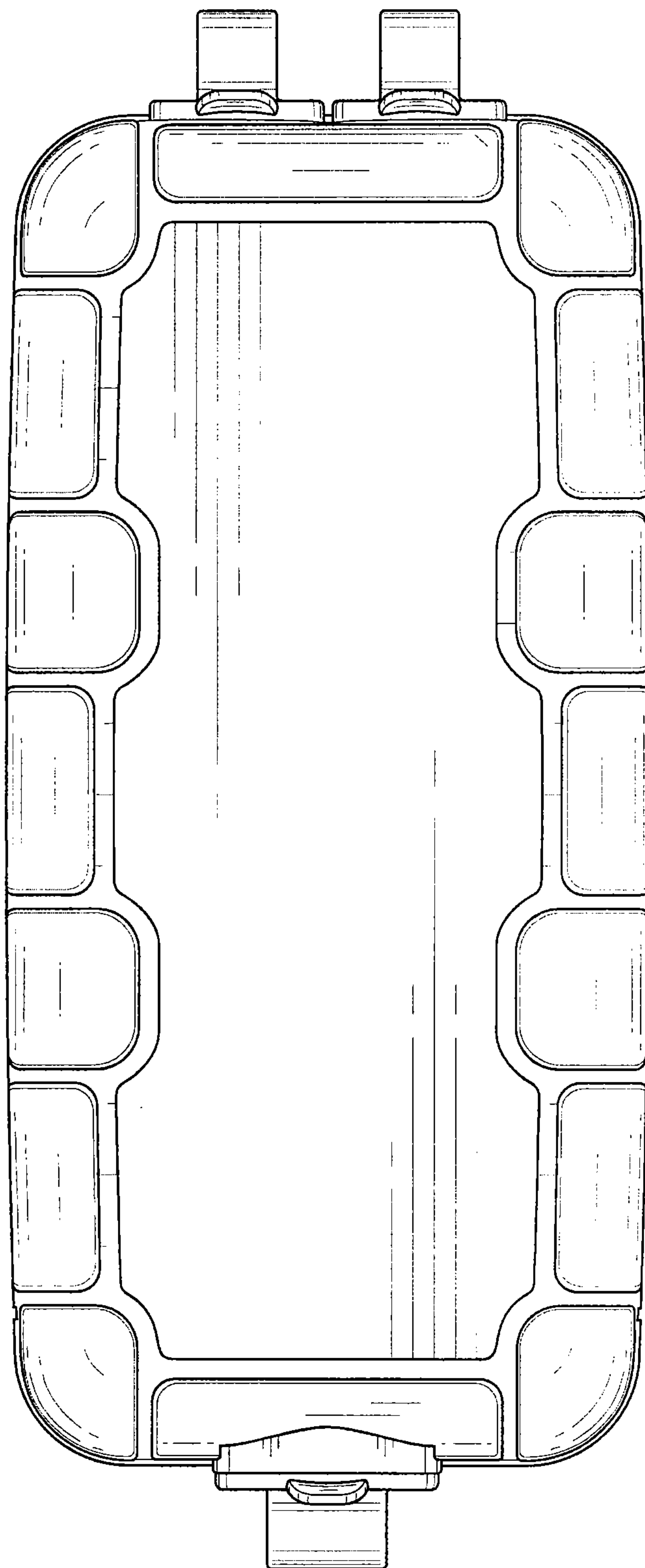

FIG. 4

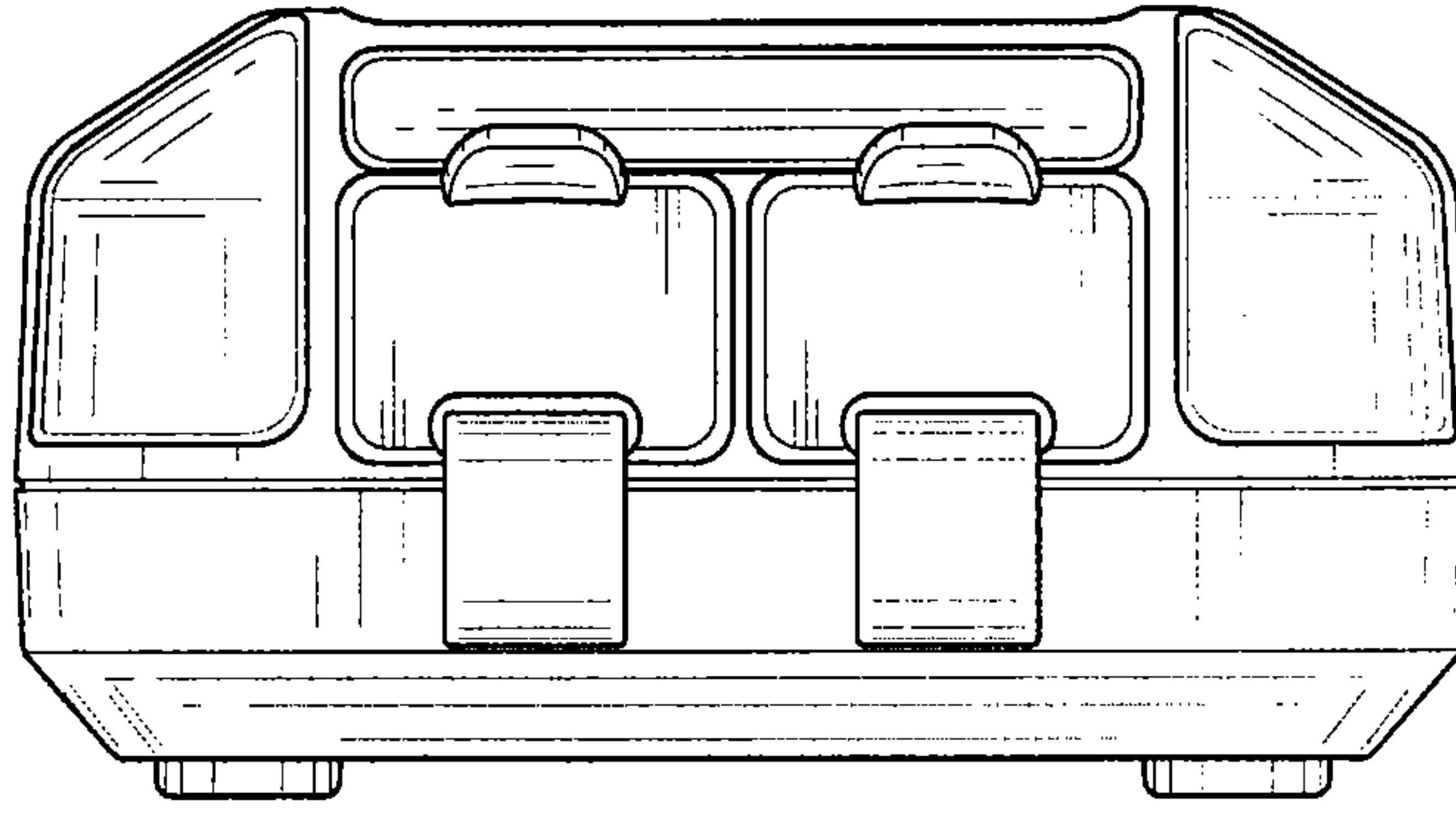

FIG. 5

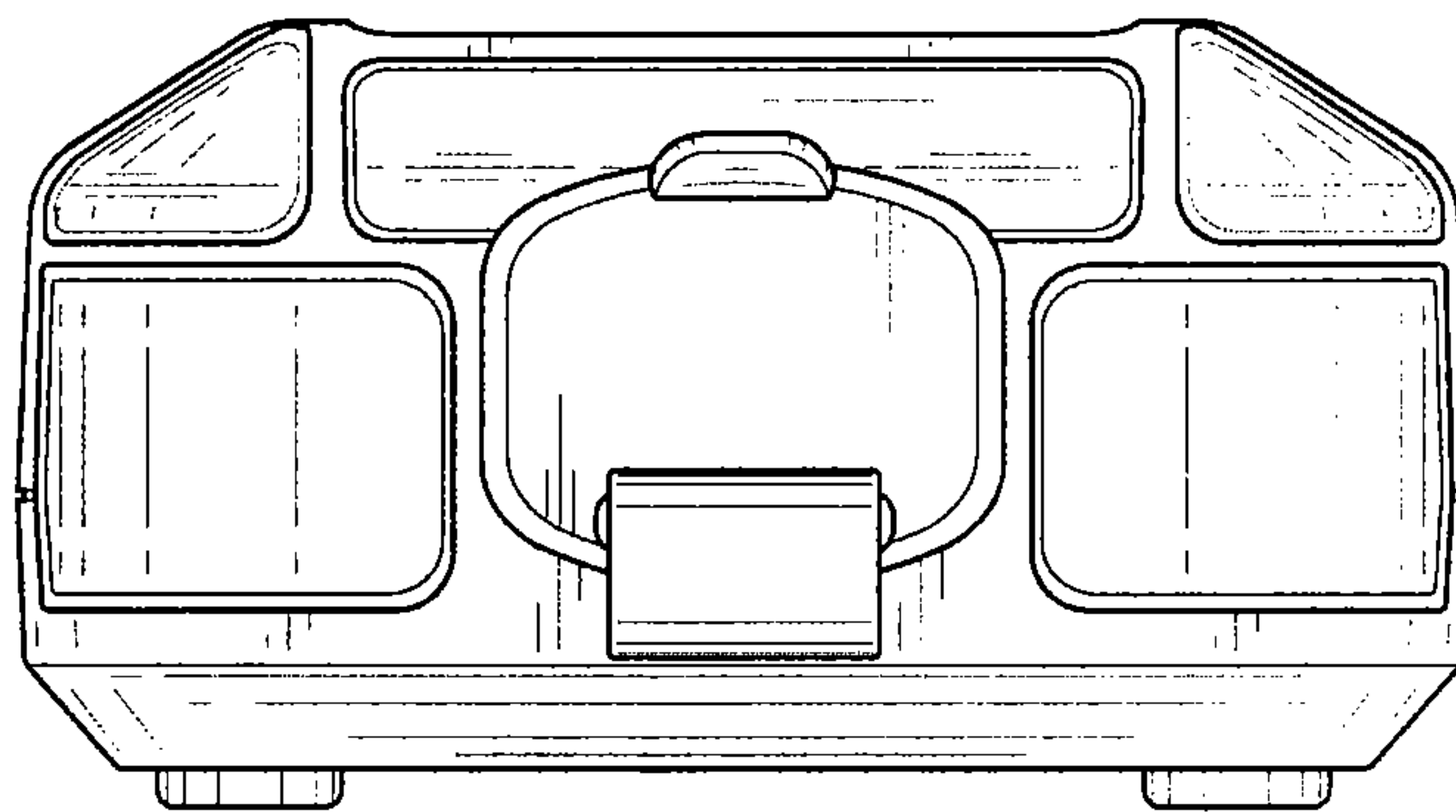

FIG. 6

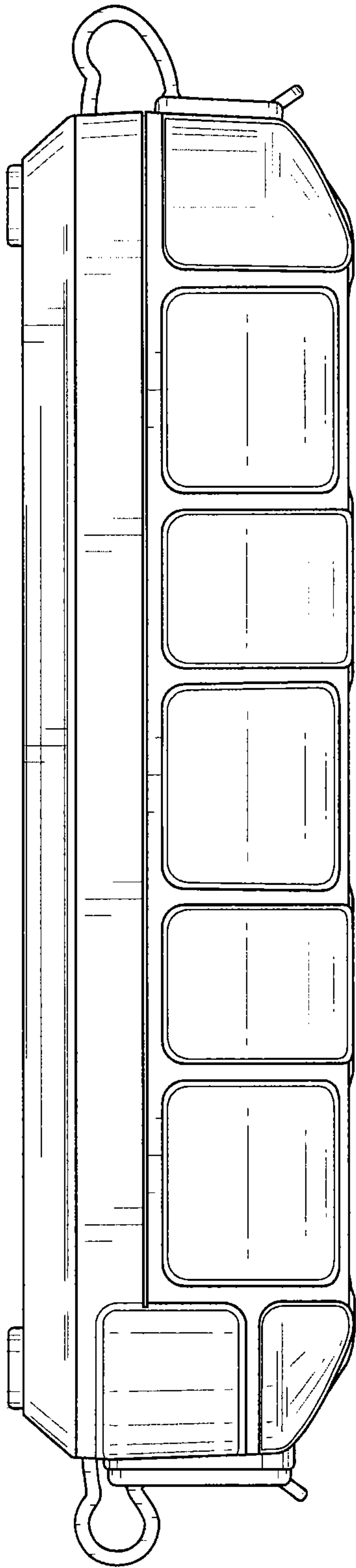

FIG. 7

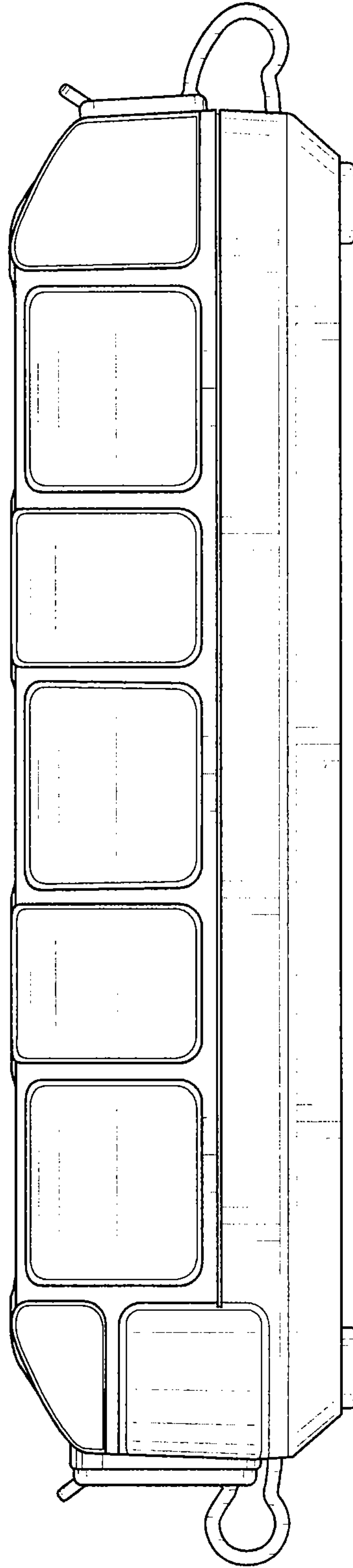

FIG. 8