



US00D745434S

(12) **United States Design Patent**  
**Tang**

(10) **Patent No.:** **US D745,434 S**  
(45) **Date of Patent:** **\*\* Dec. 15, 2015**

(54) **HINGED BUTTON COVER**

(71) Applicant: **Danny Tang**, Rowland Heights, CA  
(US)

(72) Inventor: **Danny Tang**, Rowland Heights, CA  
(US)

(\*\*) Term: **15 Years**

(21) Appl. No.: **29/534,712**

(22) Filed: **Jul. 30, 2015**

2,880,487 A \* 4/1959 Ryan ..... A44B 1/14  
24/113 MP  
3,316,601 A 5/1967 Ryan  
3,343,230 A 9/1967 Darvie  
3,923,213 A \* 12/1975 George ..... A47G 25/483  
223/96  
3,934,313 A 1/1976 Hocq  
3,942,228 A \* 3/1976 Buckman ..... A61M 39/284  
251/4  
3,962,758 A \* 6/1976 Knappe ..... B65D 85/182  
24/562  
4,539,731 A 9/1985 Torrini  
4,779,778 A 10/1988 Nixon, II

(Continued)

**Related U.S. Application Data**

(63) Continuation-in-part of application No. 14/455,641,  
filed on Aug. 8, 2014, and a continuation-in-part of  
application No. 14/491,138, filed on Sep. 19, 2014.

(51) **LOC (10) Cl.** ..... **02-07**

(52) **U.S. Cl.**  
USPC ..... **D11/222**

(58) **Field of Classification Search**  
USPC ..... D11/220, 222-241, 200, 40, 95;  
24/90.5, 113 MP, 113 R, 102 SL, 562,  
24/487, 543, 662, 102 R; 63/1.17, 1.18, 33,  
63/14.1, 14.7; 40/1.5, 315; 223/1, 96;  
251/4; D32/61; D8/395; D6/315  
CPC ..... A44B 5/00; A44B 5/02; A44B 5/002;  
A44B 1/04; A44B 1/12; A44B 1/14; A44B  
17/0011; D06F 55/00; A41F 11/04; A41F  
15/02; A44C 1/00; A44C 15/00; A44C 7/00;  
A44C 3/001; G09F 3/04  
See application file for complete search history.

(56) **References Cited**

**U.S. PATENT DOCUMENTS**

581,111 A \* 4/1897 Goodwin ..... A44B 1/14  
40/315  
834,943 A \* 11/1906 Steinberg ..... A44B 5/00  
24/90.5  
1,747,322 A 2/1930 Riker  
2,751,654 A \* 6/1956 Armbruster ..... A44B 1/14  
24/113 MP

**FOREIGN PATENT DOCUMENTS**

WO 2007061261 A1 5/2007

*Primary Examiner* — T. Chase Nelson

*Assistant Examiner* — Mark Cavanna

(74) *Attorney, Agent, or Firm* — Pacifica IP

(57) **CLAIM**

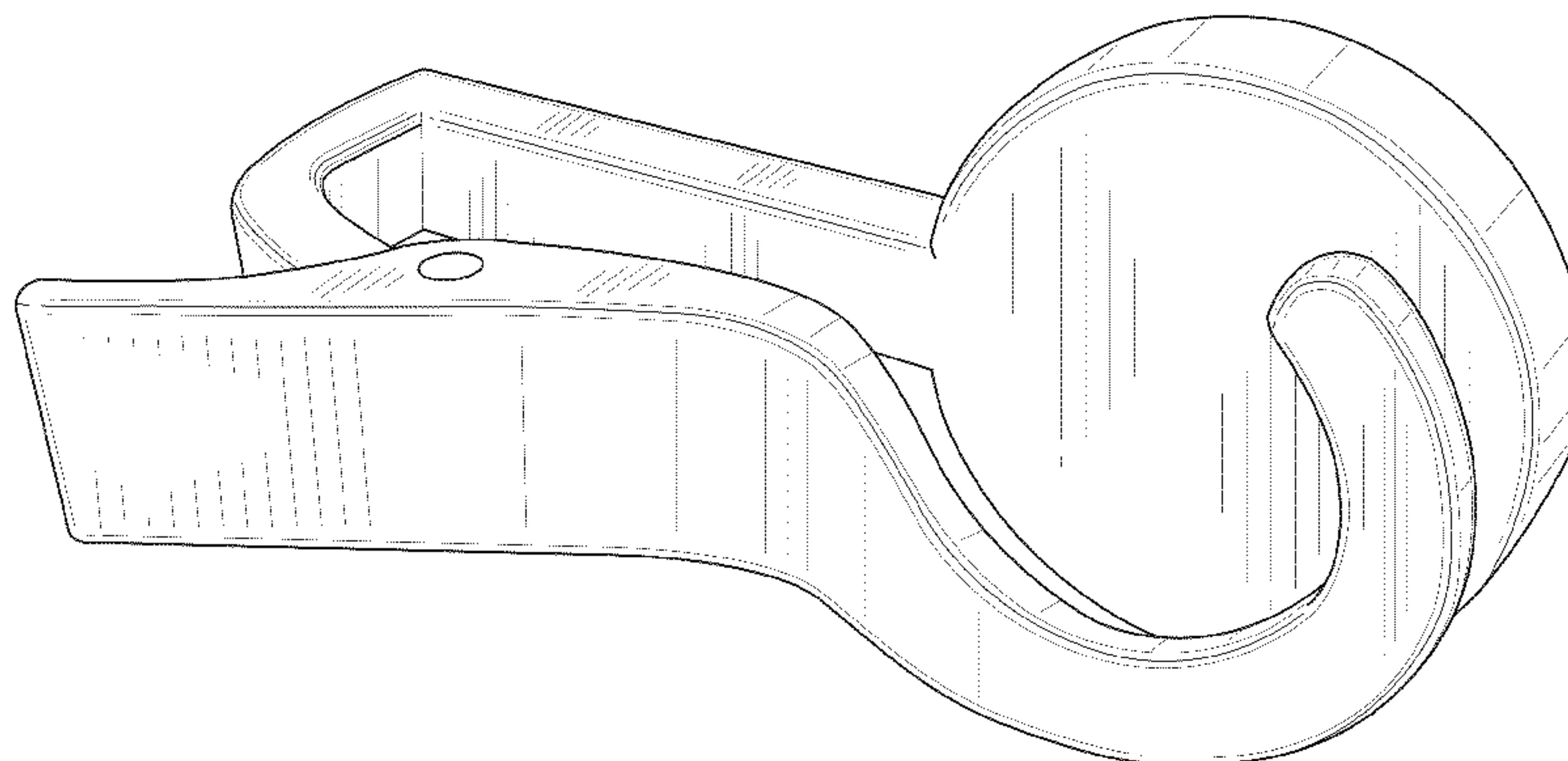
The ornamental design for a hinged button cover, as shown  
and described.

**DESCRIPTION**

FIG. 1 shows a rear perspective view of a hinged button cover;  
FIG. 2 shows a right side elevational view of the hinged button  
cover FIG. 1;  
FIG. 3 shows a left side elevational view of the hinged button  
cover of FIG. 1;  
FIG. 4 shows a rear elevational view of the hinged button  
cover of FIG. 1;  
FIG. 5 shows a front elevational view of the hinged button  
cover of FIG. 1;  
FIG. 6 shows a bottom plan view of the hinged button cover  
of FIG. 1; and,  
FIG. 7 shows a top plan view of hinged button cover of FIG.  
1.

The broken lines shown in the drawings depict portions of the  
hinged button cover that form no part of the claimed design.

**1 Claim, 7 Drawing Sheets**



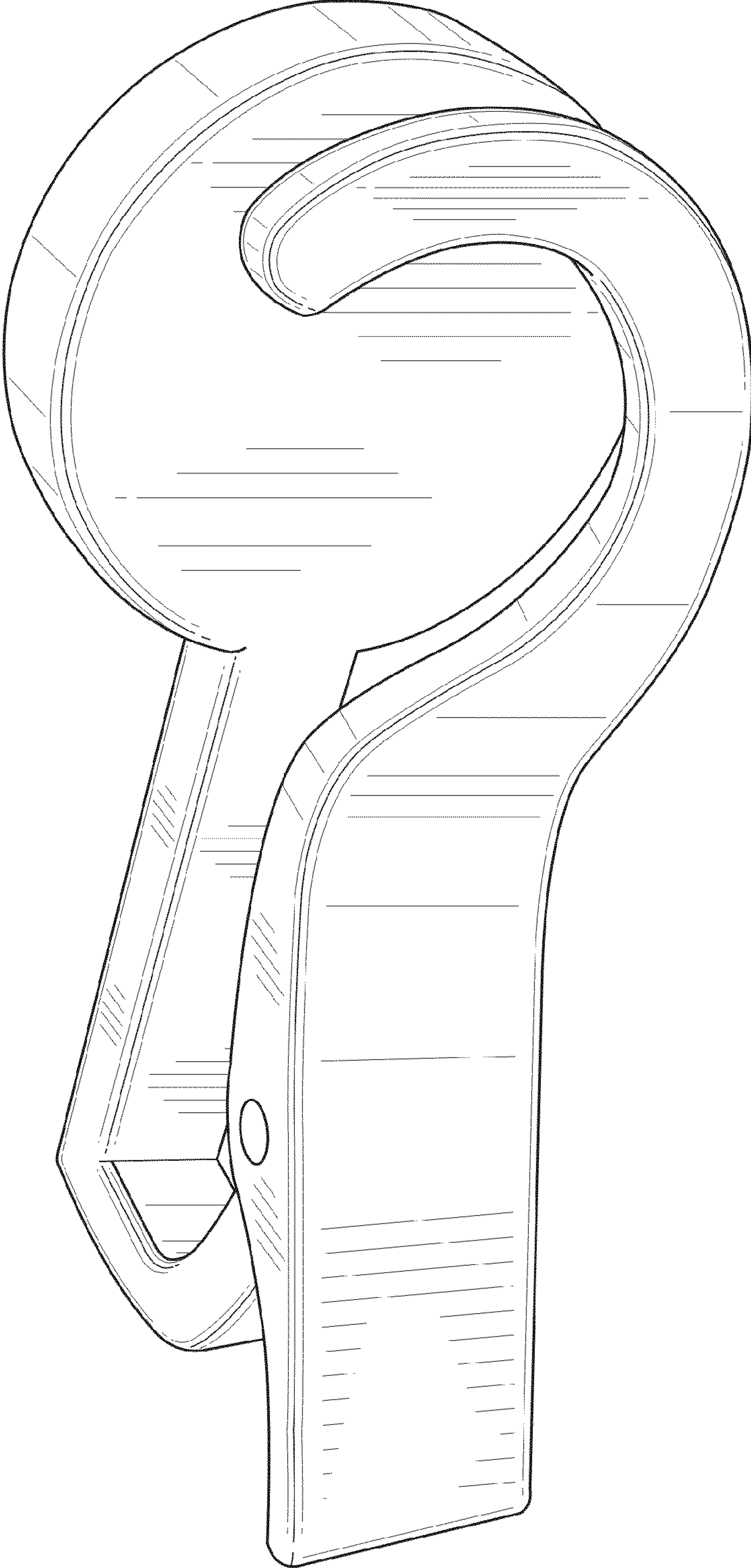
(56)

References Cited

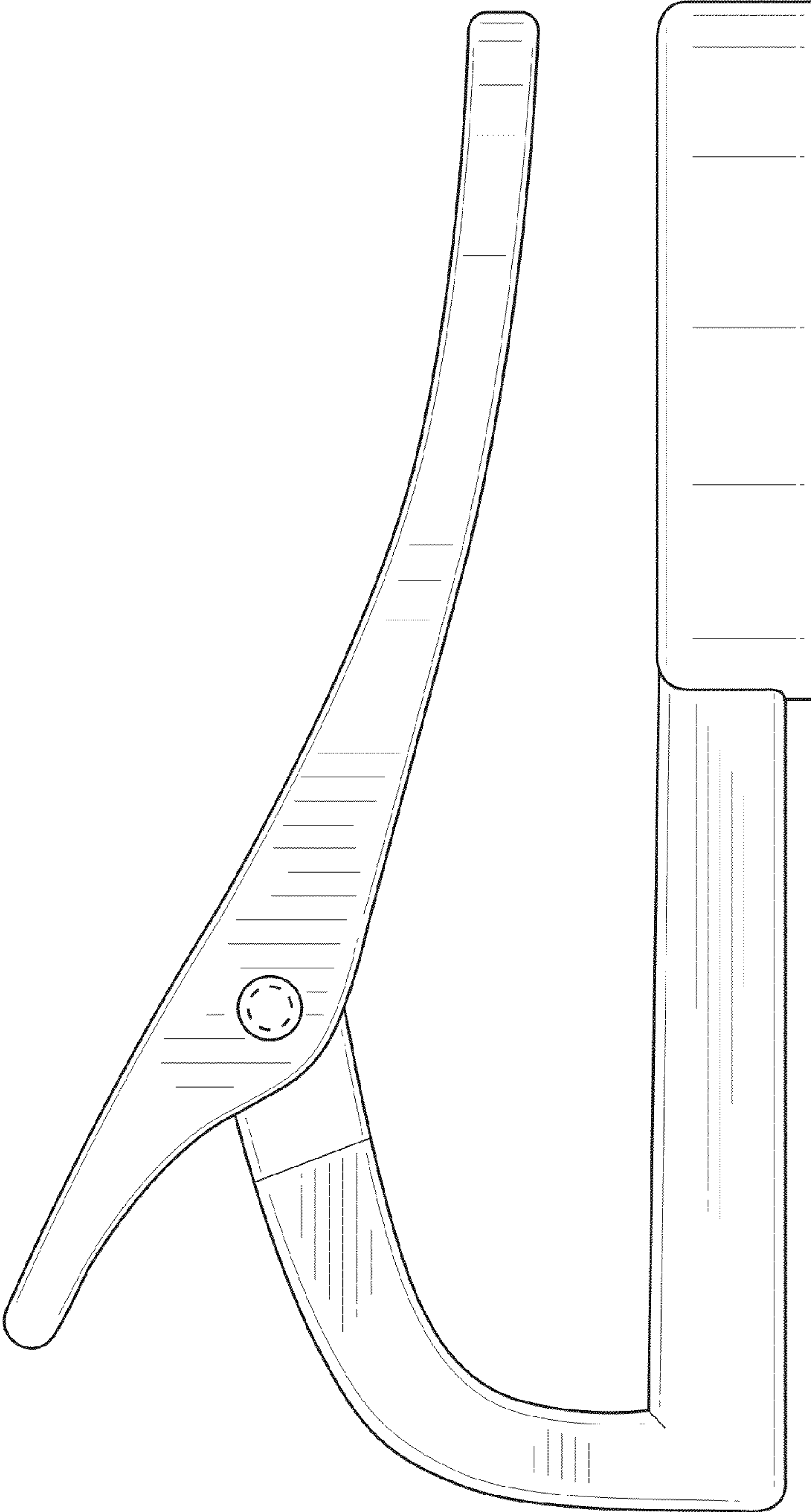
U.S. PATENT DOCUMENTS

4,807,334 A *	2/1989	Blanchard	.....	A44B 99/00	24/487	5,944,236 A *	8/1999	Cinque	.....	D06F 95/008	223/1
4,817,249 A	4/1989	Astier				6,035,494 A	3/2000	Duke et al.			
5,060,356 A	10/1991	Szedzinski				6,463,636 B1 *	10/2002	Friedewald	.....	A41B 11/002	24/662
D327,149 S *	6/1992	Harper, IV	.....	D32/61		6,857,167 B2	2/2005	Bishop			
5,159,730 A *	11/1992	Radvin	.....	A44B 99/00	24/543	D504,576 S *	5/2005	Strollo	.....	D6/315	
5,161,285 A	11/1992	Jerjian				7,203,999 B2	4/2007	Bagot			
5,337,584 A	8/1994	Angeli				7,350,274 B2	4/2008	Rogers			
5,361,459 A	11/1994	Hyvonen et al.				7,743,471 B2	6/2010	Rogers			
5,379,611 A *	1/1995	Impagliazzo	.....	A44C 15/001	63/14.1	8,042,233 B2 *	10/2011	Surratt	.....	F21S 8/00	24/102 R
5,394,719 A	3/1995	Fang				D712,308 S	9/2014	Weber et al.			
D368,589 S *	4/1996	Guio	.....	D32/61		D720,255 S	12/2014	Gramatikas			
5,546,641 A *	8/1996	Radvin	.....	A41F 19/005	24/562	2004/0226145 A1	11/2004	Ouellette et al.			
5,621,951 A	4/1997	Gould				2008/0313864 A1	12/2008	Suter			
5,673,465 A	10/1997	Singapuri				2011/0000052 A1	1/2011	Suter			
D386,215 S *	11/1997	White	.....	D8/395		2011/0056049 A1	3/2011	Rice			
5,901,417 A *	5/1999	Alexiou	.....	A44B 1/14	24/90.5	2011/0061207 A1	3/2011	Forbes			
						2011/0271715 A1	11/2011	Stone			
						2011/0277502 A1	11/2011	Welikson			
						2012/0030863 A1	2/2012	Marasco et al.			
						2012/0240356 A1	9/2012	Nathanson			
						2012/0278973 A1	11/2012	Berkowitz et al.			

\* cited by examiner

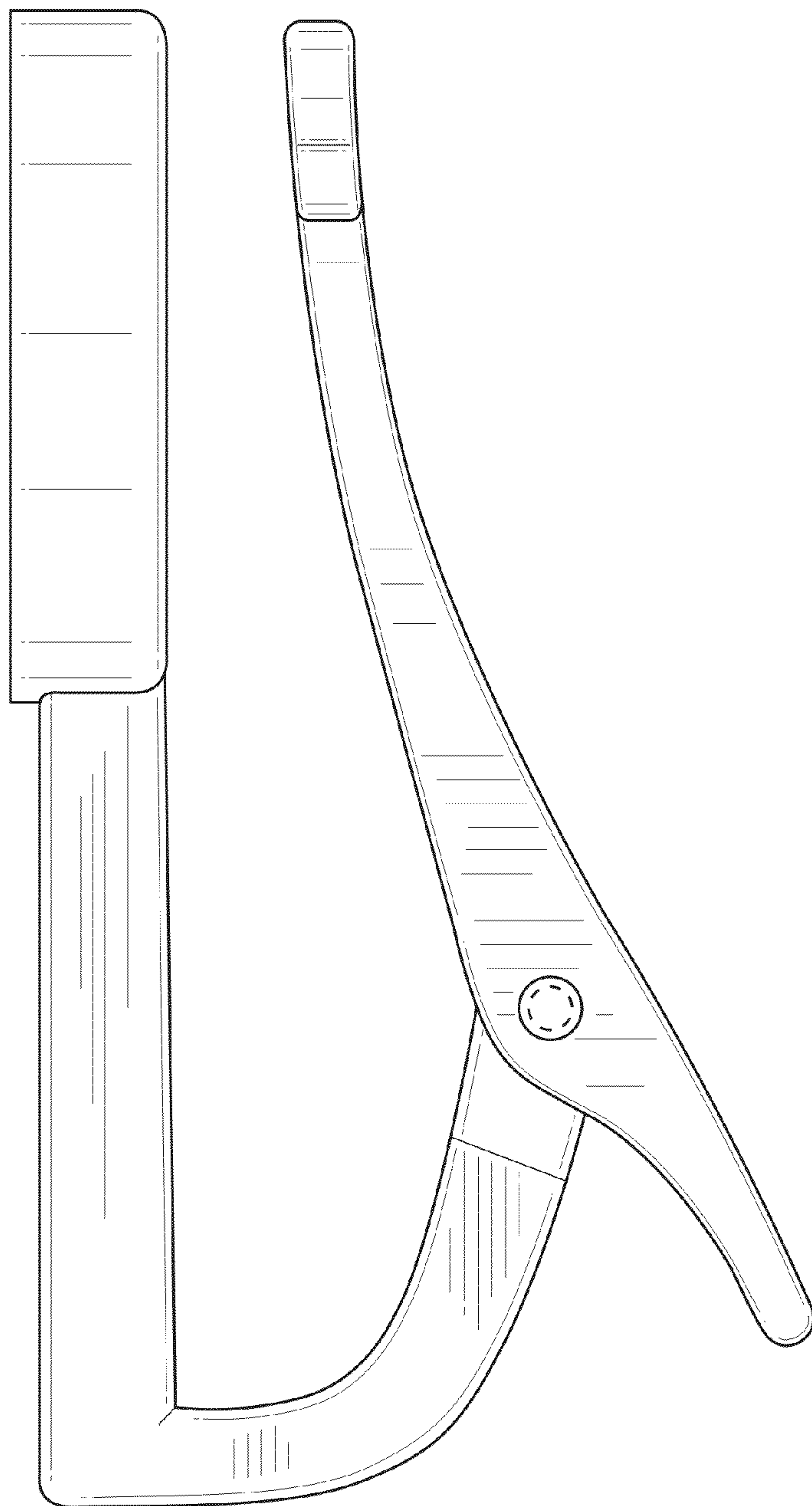


**FIG. 1**

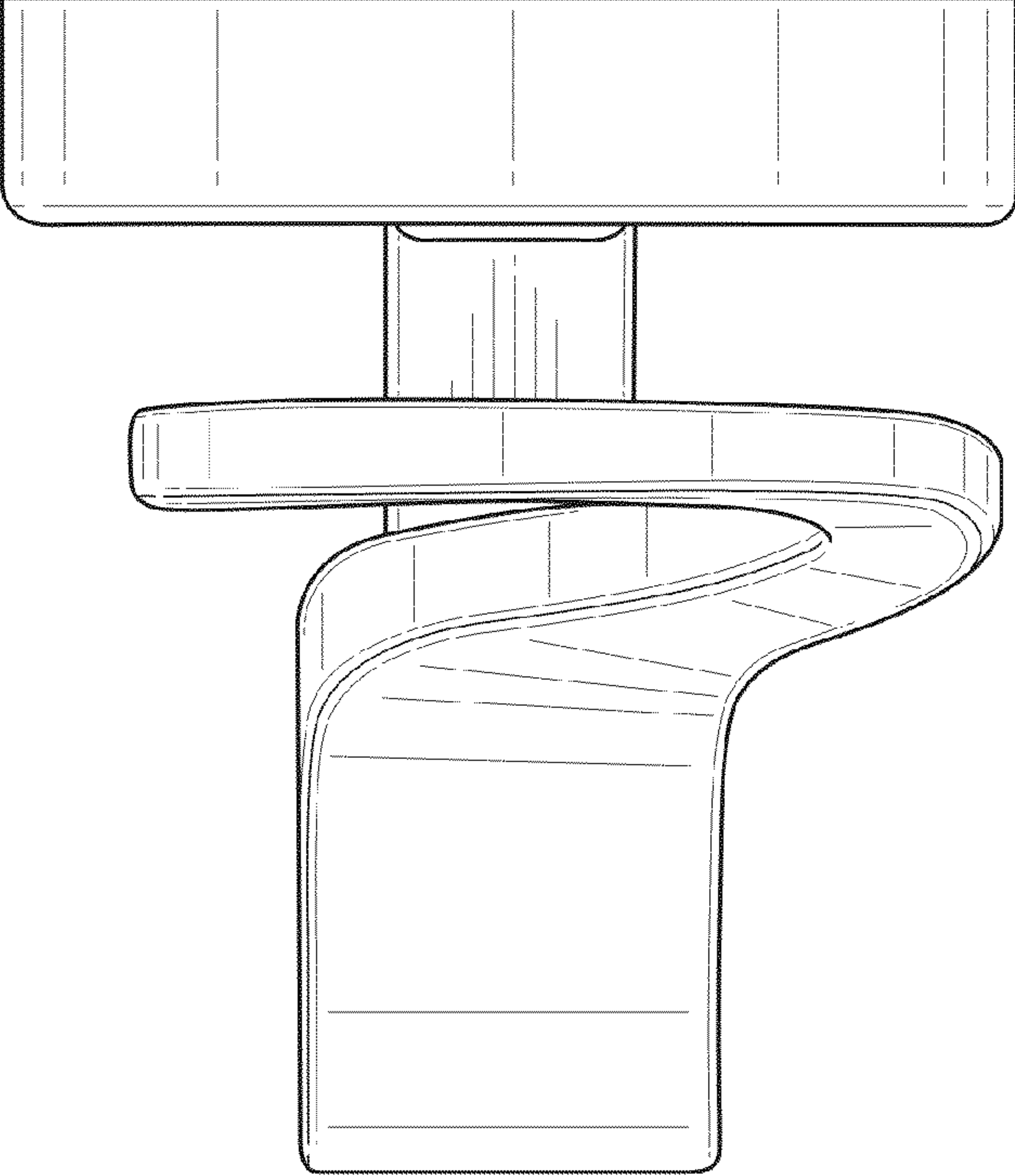


**FIG. 2**

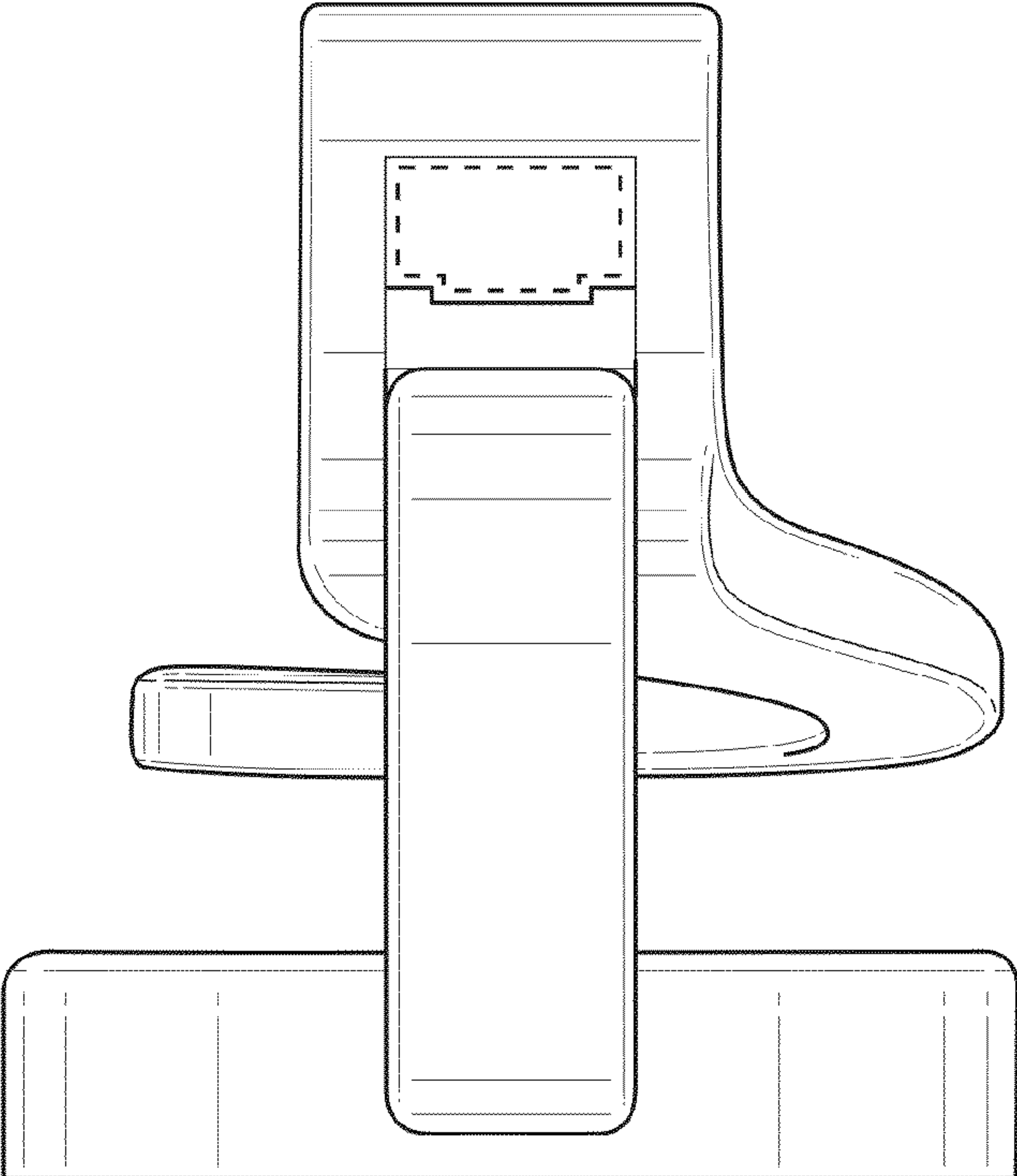




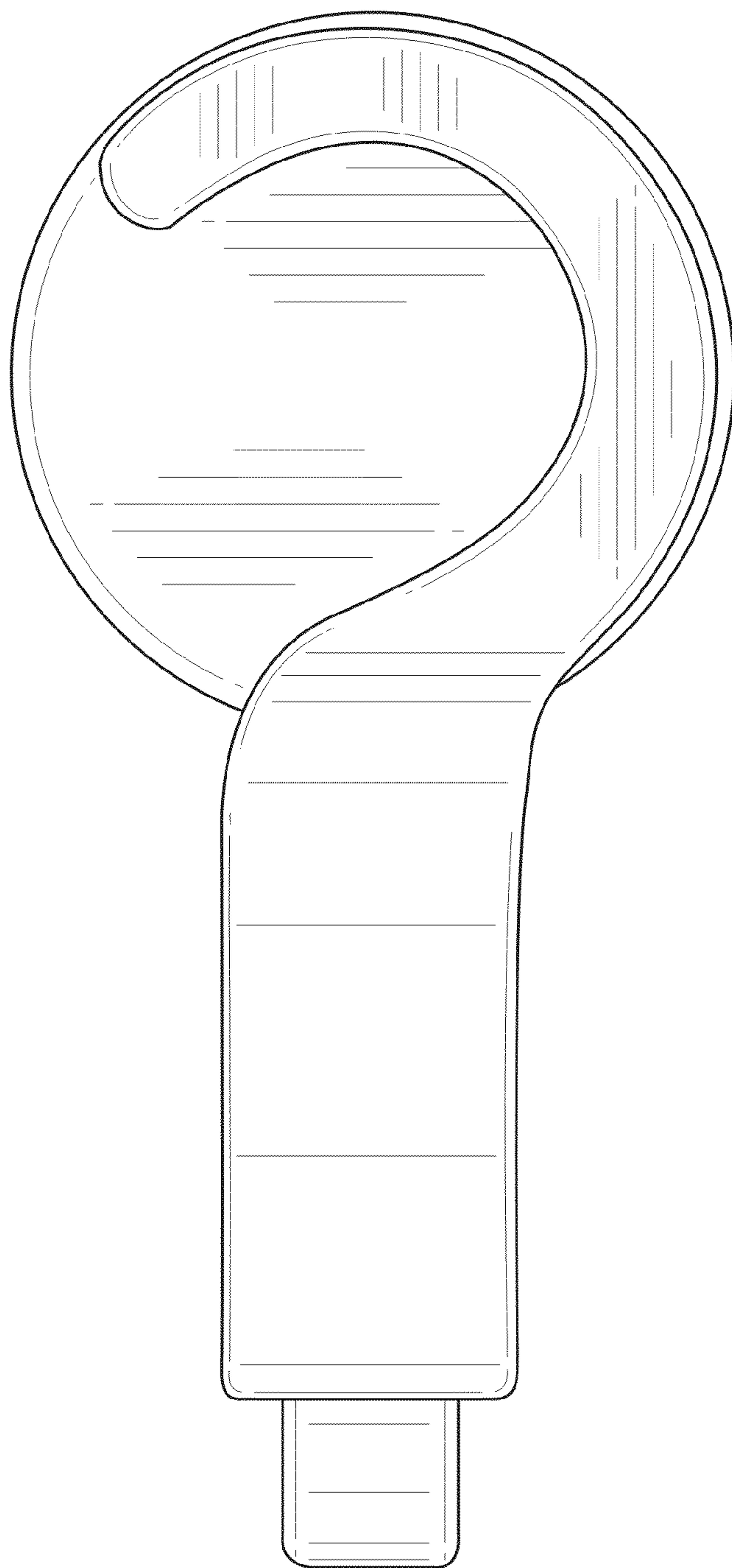
**FIG. 3**



**FIG. 4**

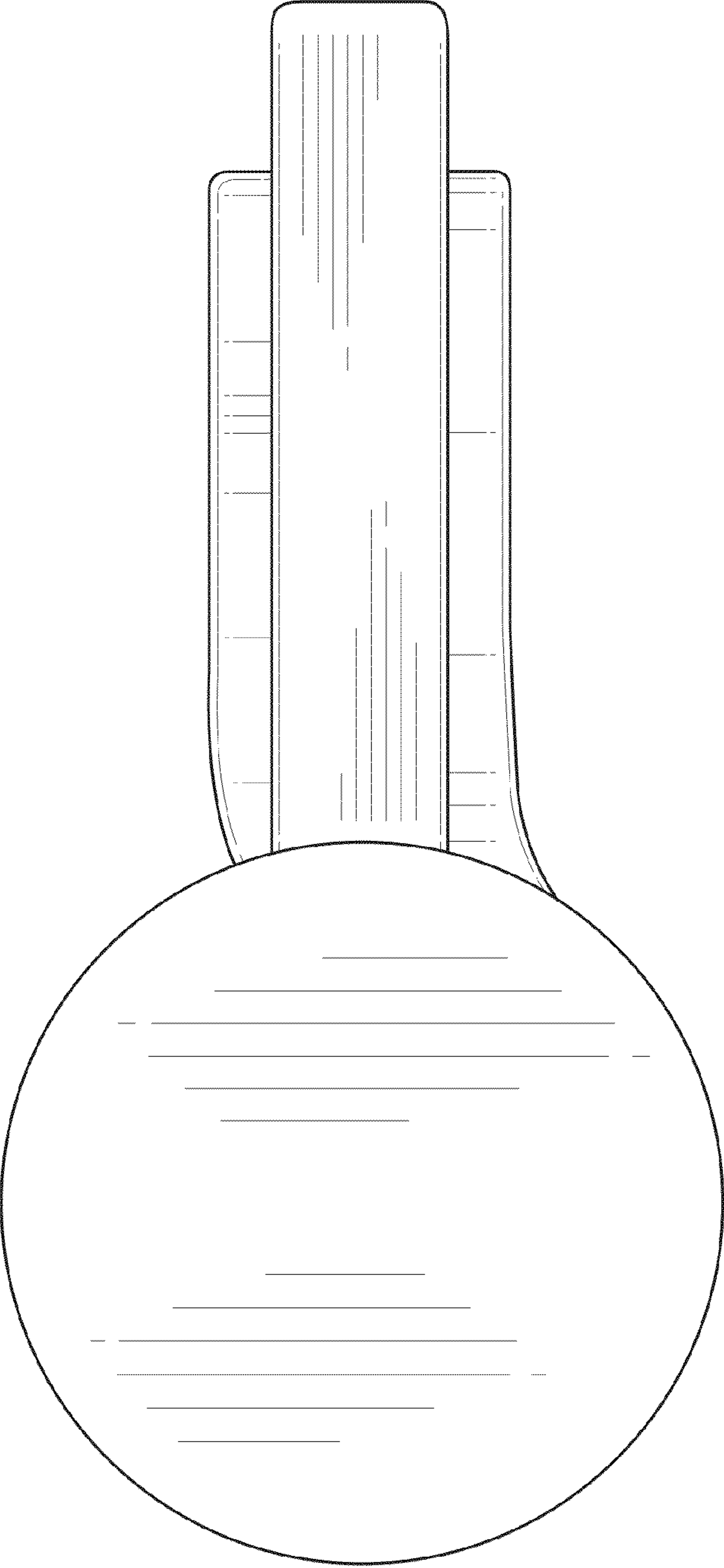


**FIG. 5**



**FIG. 6**





**FIG. 7**