



US00D745392S

(12) **United States Design Patent**  
**Solovov, Jr. et al.**

(10) **Patent No.:** **US D745,392 S**  
(45) **Date of Patent:** **\*\* Dec. 15, 2015**

(54) **BOX FOR AMMUNITION**

(71) Applicant: **TULAMMO USA, INC.**, Round Rock, TX (US)

(72) Inventors: **Alexey Alexeevich Solovov, Jr.**, Tula (RU); **Maxim Nikolaevich Buyanov**, Tula (RU)

(73) Assignee: **Tulammo USA, Inc.**, Round Rock, TX (US)

(\*\*) Term: **14 Years**

(21) Appl. No.: **29/503,535**

(22) Filed: **Sep. 26, 2014**

(51) **LOC (10) Cl.** ..... **09-03**

(52) **U.S. Cl.**  
USPC ..... **D9/433**

(58) **Field of Classification Search**  
USPC ..... D9/432, 433; D3/203.2, 262, 228, 221, D3/225; 206/3, 223  
CPC .... G11B 33/0494; B65D 85/546; F42B 39/26  
See application file for complete search history.

(56) **References Cited**

**U.S. PATENT DOCUMENTS**

2,305,198	A *	12/1942	Shonblom	206/3
2,325,755	A *	8/1943	Eggebrecht	206/3
2,354,239	A	7/1944	Williamson	
2,386,546	A *	10/1945	Ely et al.	206/3
2,626,077	A *	1/1953	Marshall	217/28
2,660,300	A *	11/1953	Pauls	206/3

(Continued)

**OTHER PUBLICATIONS**

Design U.S. Appl. No. 29/503,535 Notice of Allowance mailed May 29, 2015 (9 pages).

*Primary Examiner* — Philip S Hyder

*Assistant Examiner* — Keith Frank

(74) *Attorney, Agent, or Firm* — Polsinelli PC

(57) **CLAIM**

The ornamental design for a box for ammunition, as shown and described.

**DESCRIPTION**

U.S. Design patent application Ser. Nos. 29/503,546, 29/503,545, 29/503,548, and 29/503,553 filed on Sep. 26, 2014 are hereby incorporated by reference in their entireties.

FIG. 1 is a perspective view of the box for ammunition;

FIG. 2 is a front view of the box for ammunition;

FIG. 3 is a rear view of the box for ammunition;

FIG. 4 is a right side view of the box for ammunition;

FIG. 5 is a left side view of the box for ammunition;

FIG. 6 is a top view of the box for ammunition;

FIG. 7 is a bottom view of the box for ammunition;

FIG. 8 is perspective view of the box for ammunition in a flattened configuration;

FIG. 9 is a top view of the box for ammunition in a flattened configuration;

FIG. 10 is a bottom view of the box for ammunition in a flattened configuration;

FIG. 11 is a front view of the box for ammunition in a flattened configuration;

FIG. 12 is a rear view of the box for ammunition in a flattened configuration;

FIG. 13 is a left view of the box for ammunition in a flattened configuration; and,

FIG. 14 is a right view of the box for ammunition in a flattened configuration.

The broken lines in the drawings depict fold lines and form no part of the claimed design.

**1 Claim, 7 Drawing Sheets**

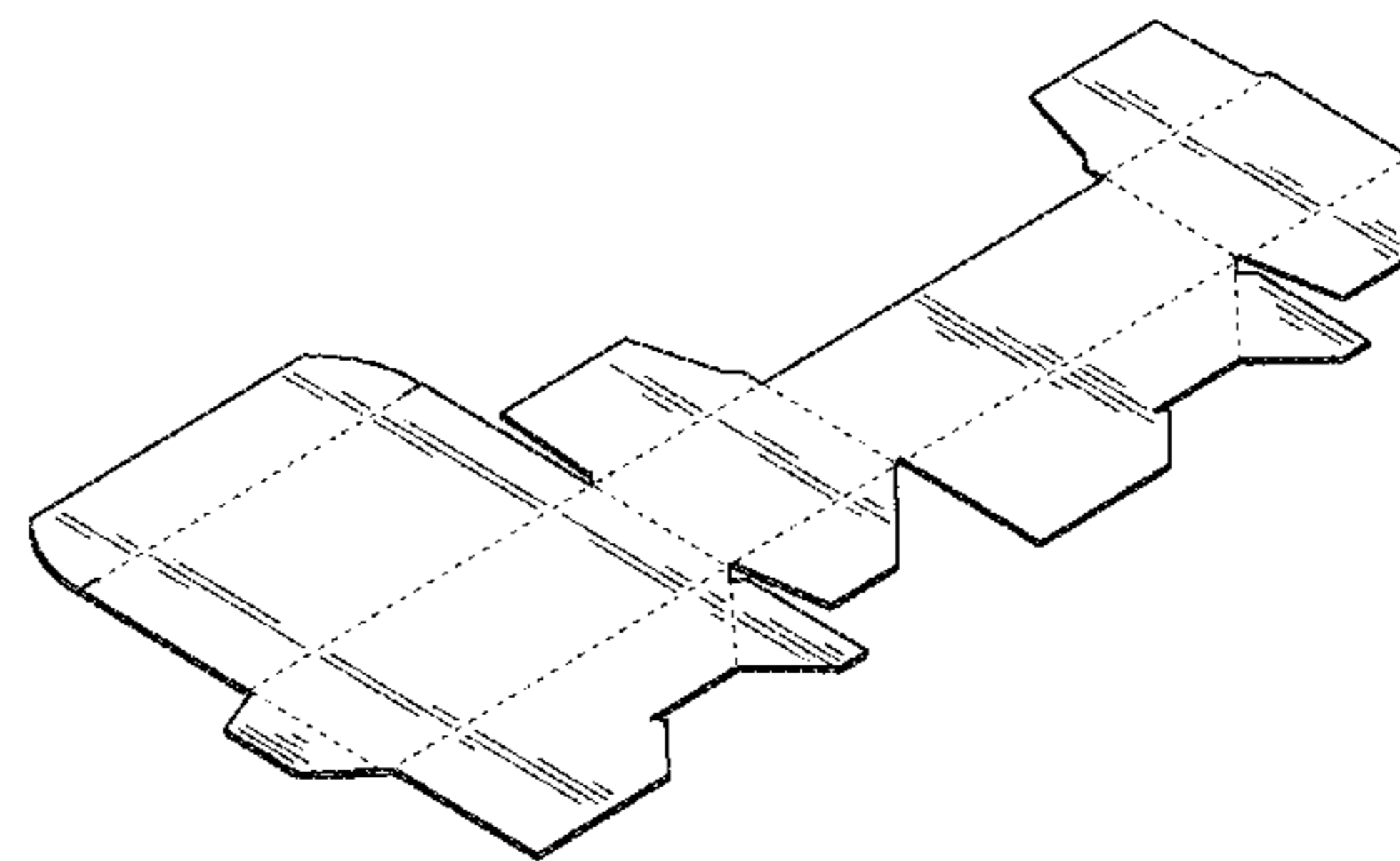
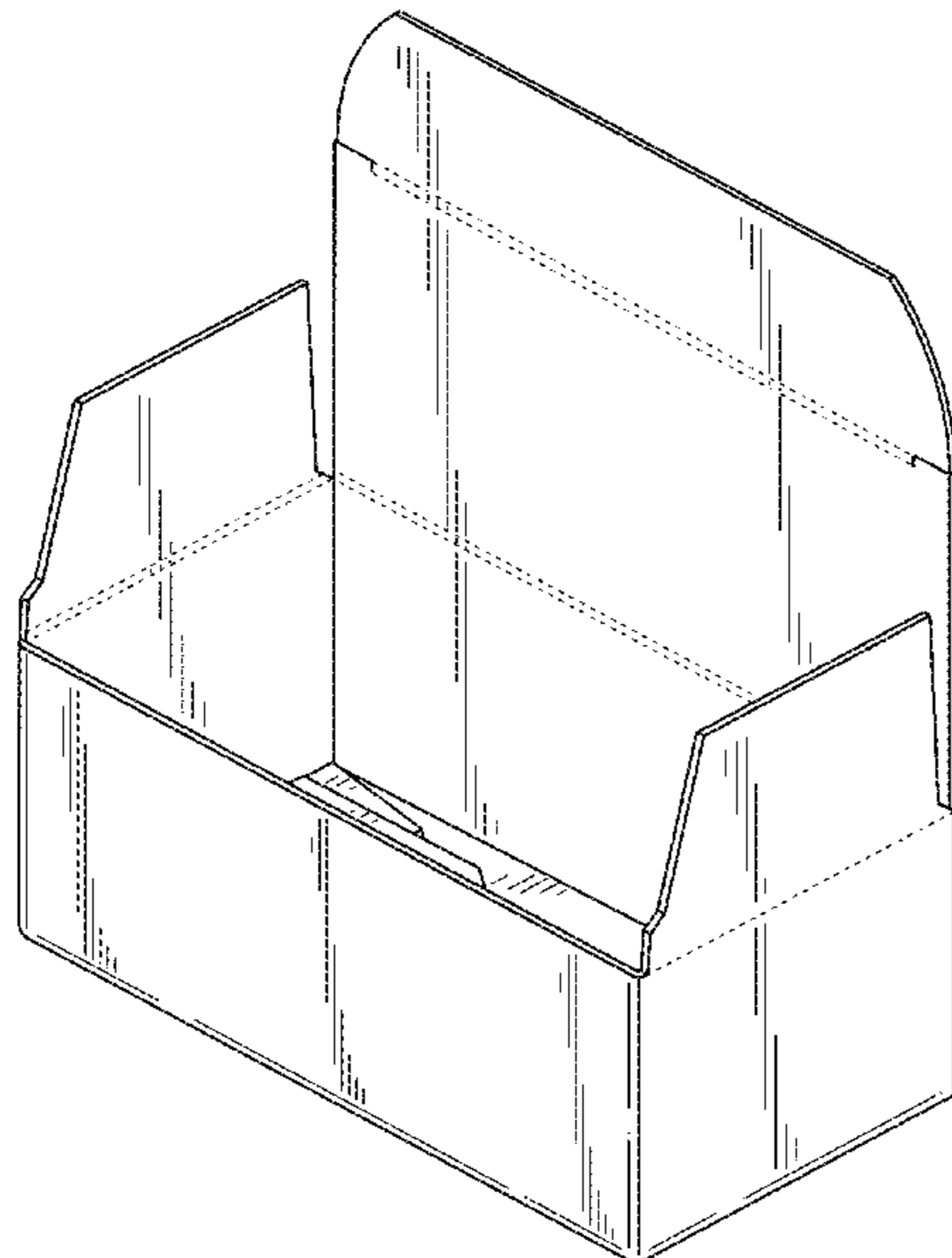

(56)

References Cited

U.S. PATENT DOCUMENTS

2,673,679	A *	3/1954	La Bombard	.....	229/117.04	5,450,947	A *	9/1995	Sgueglia, Sr.	.....	206/3
2,788,827	A	4/1957	Banner			D376,759	S	12/1996	Bradfield		
3,235,167	A	2/1966	Svensson			D444,381	S	7/2001	Barr		
3,515,321	A *	6/1970	Webster	.....	206/3	6,604,676	B2	8/2003	Giblin		
3,595,466	A	7/1971	Rosenburg, Jr.			6,779,654	B1 *	8/2004	Marquis	.....	206/3
3,893,614	A	7/1975	Meyers			D533,078	S	12/2006	Lebras		
4,003,516	A	1/1977	Commerford et al.			D582,270	S *	12/2008	Magnusson	.....	D9/433
4,083,455	A	4/1978	Keating, Jr.			D583,660	S	12/2008	Steiger et al.		
D252,915	S *	9/1979	Wilson	.....	D9/433	D586,209	S *	2/2009	Cadmus et al.	.....	D9/433
D260,000	S *	7/1981	Roccaforte	.....	D9/433	D606,855	S	12/2009	Jo et al.		
4,489,878	A *	12/1984	Mode	.....	229/117	D629,296	S *	12/2010	De Muynck	.....	D9/433
D284,714	S *	7/1986	Thor	.....	D3/225	7,918,153	B1 *	4/2011	Gordon et al.	.....	89/33.14
D294,805	S	3/1988	Boyer			D652,295	S *	1/2012	Hipperson et al.	.....	D9/433
D298,515	S	11/1988	Pennell			8,328,078	B2	12/2012	Modha et al.		
D305,101	S *	12/1989	Winterling	.....	D9/416	D693,680	S	11/2013	Klopp et al.		
D309,107	S *	7/1990	Winterling	.....	D9/433	D695,605	S	12/2013	Johnson		
D329,375	S *	9/1992	Bergman	.....	D9/759	D696,135	S	12/2013	Larson et al.		
D336,428	S *	6/1993	Buratto	.....	D9/432	D696,960	S	1/2014	Larson et al.		
D337,940	S	8/1993	Aquino			D704,550	S *	5/2014	Mattila et al.	.....	D9/432
5,275,331	A *	1/1994	Chung-Piao	.....	229/117.15	D719,018	S *	12/2014	Levy et al.	.....	D9/432
D345,101	S	3/1994	Abrams			D719,442	S *	12/2014	Lucht	.....	D9/433
D346,326	S	4/1994	Price, Sr. et al.			D724,940	S *	3/2015	Kim et al.	.....	D9/423
						D726,533	S	4/2015	Northrup		
						2005/0150781	A1 *	7/2005	Barton et al.	.....	206/3
						2012/0234904	A1	9/2012	Costanzo, Jr.		

\* cited by examiner

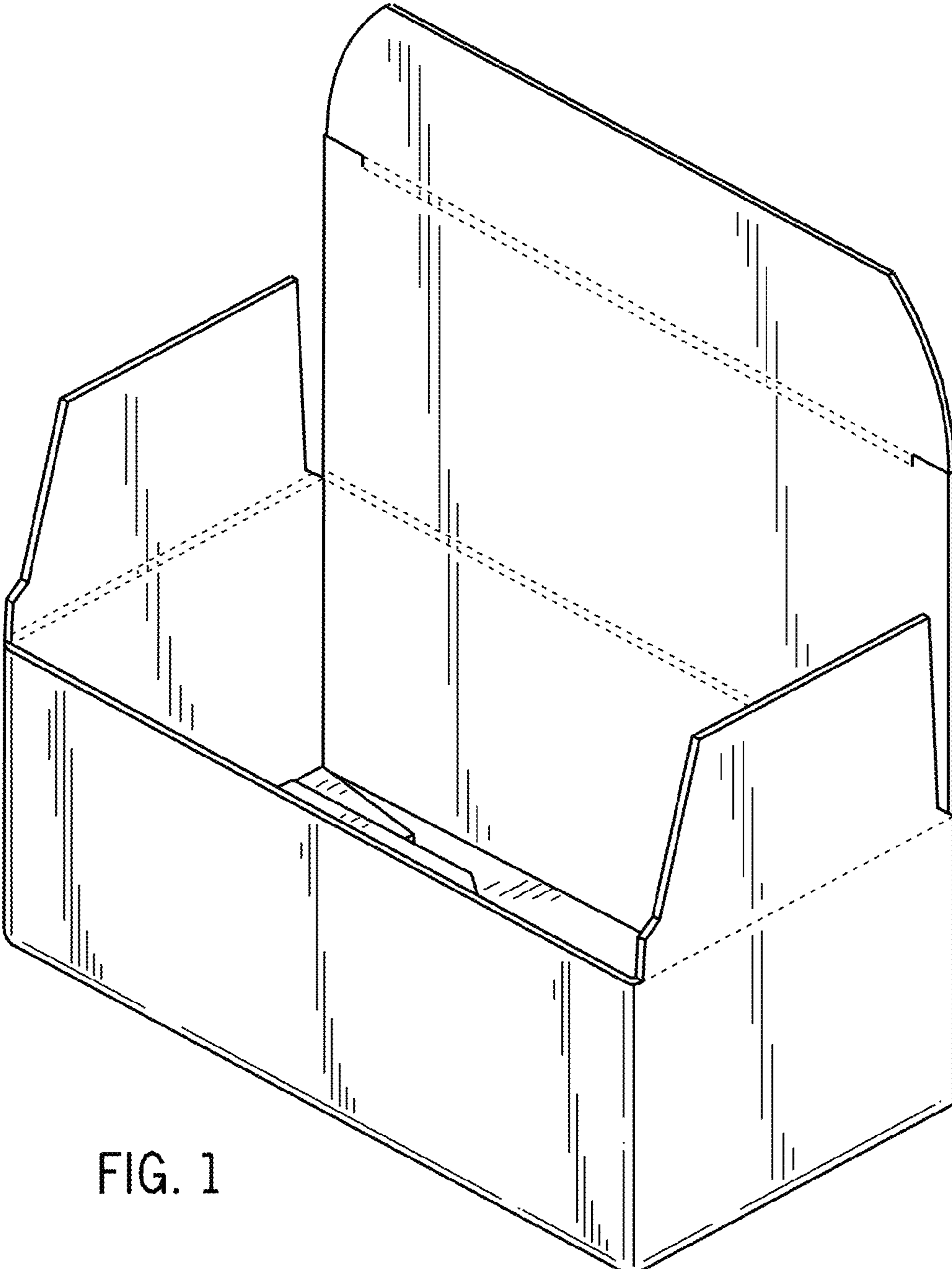

FIG. 1

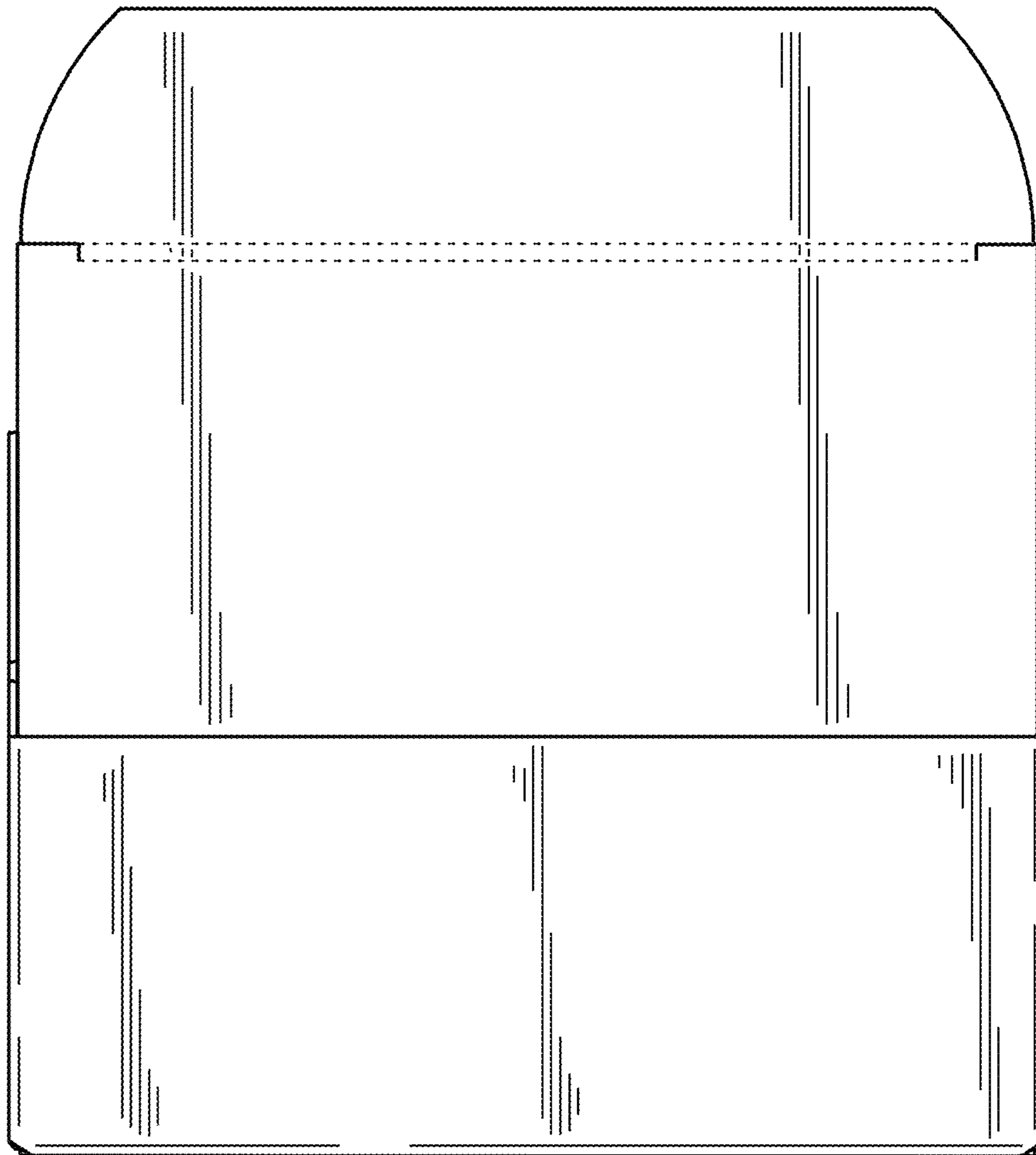

FIG. 2

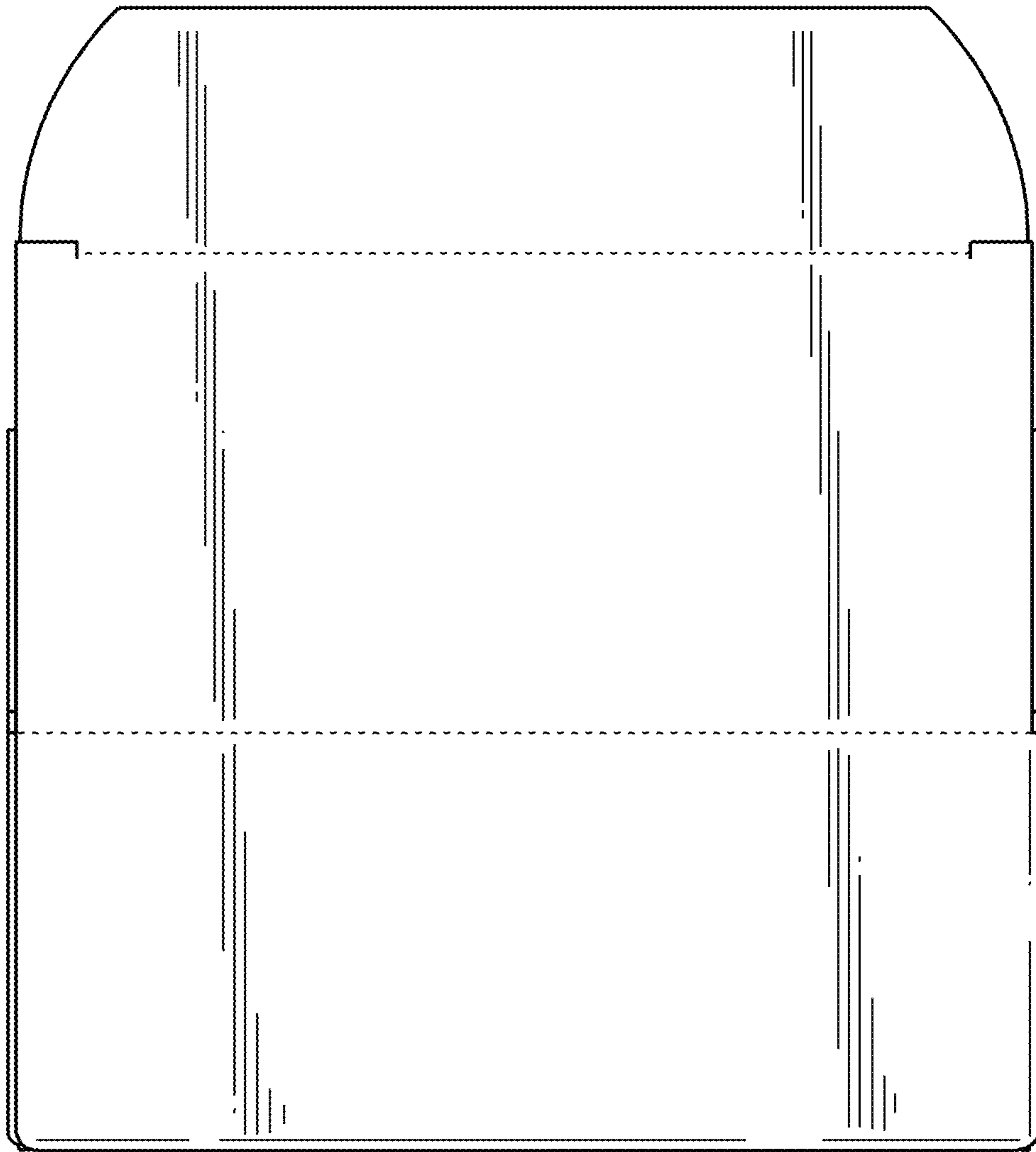

FIG. 3

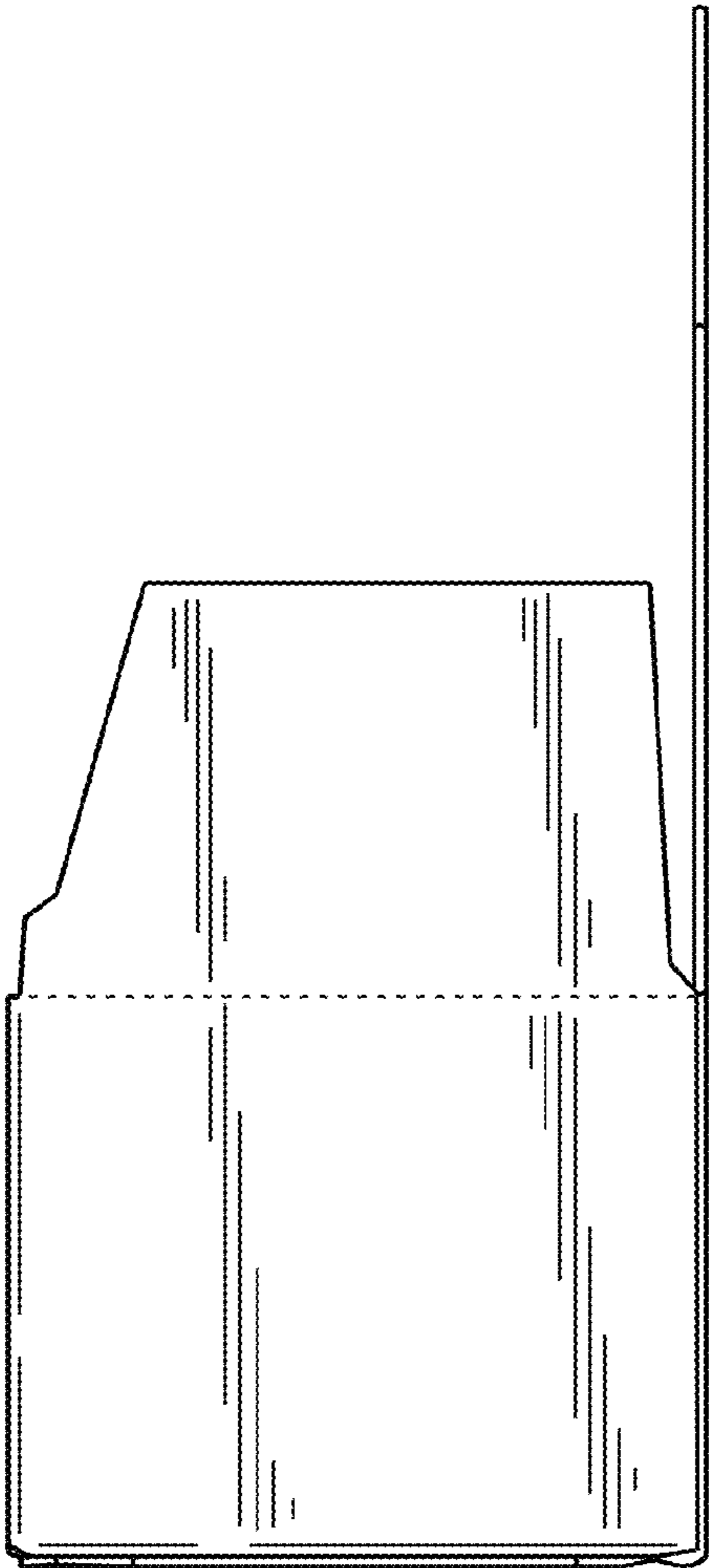

FIG. 4

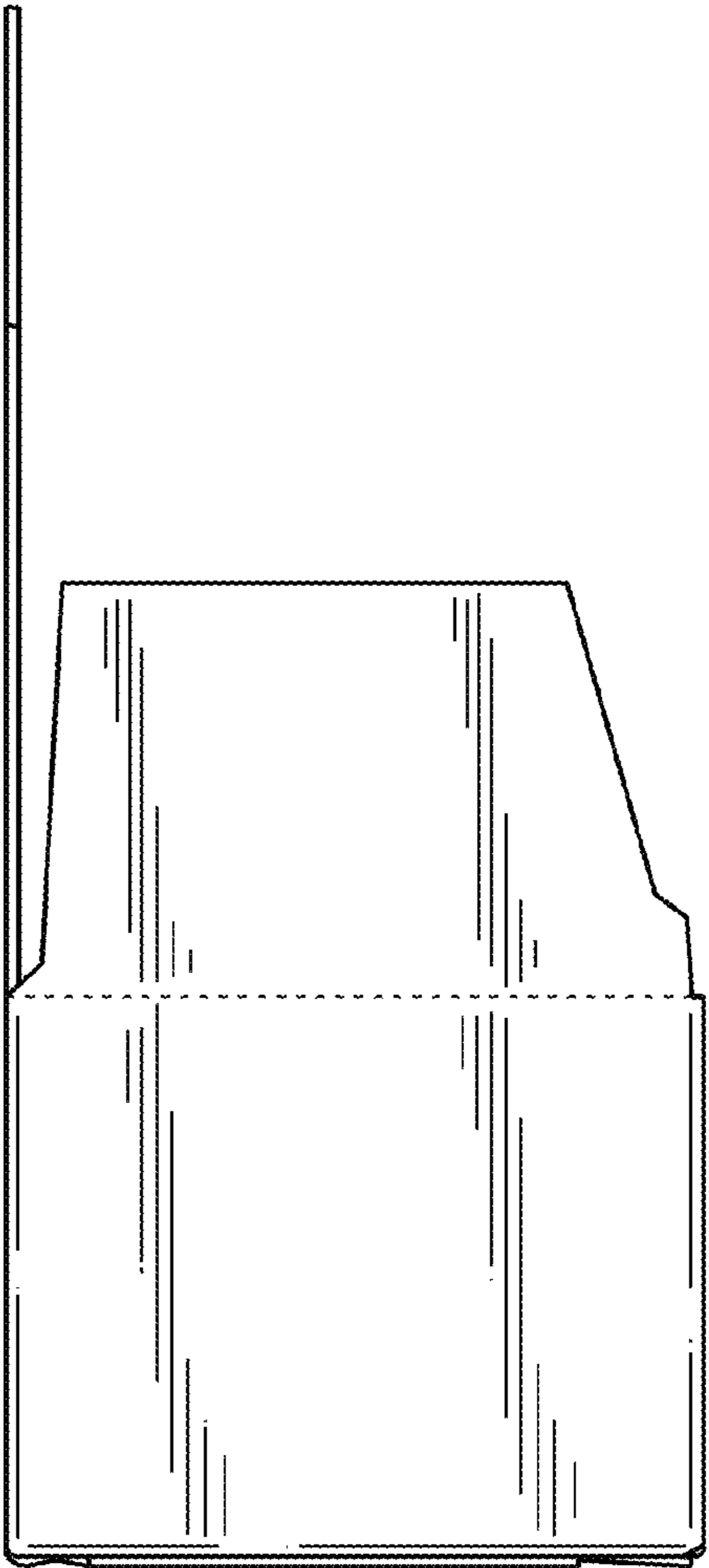

FIG. 5

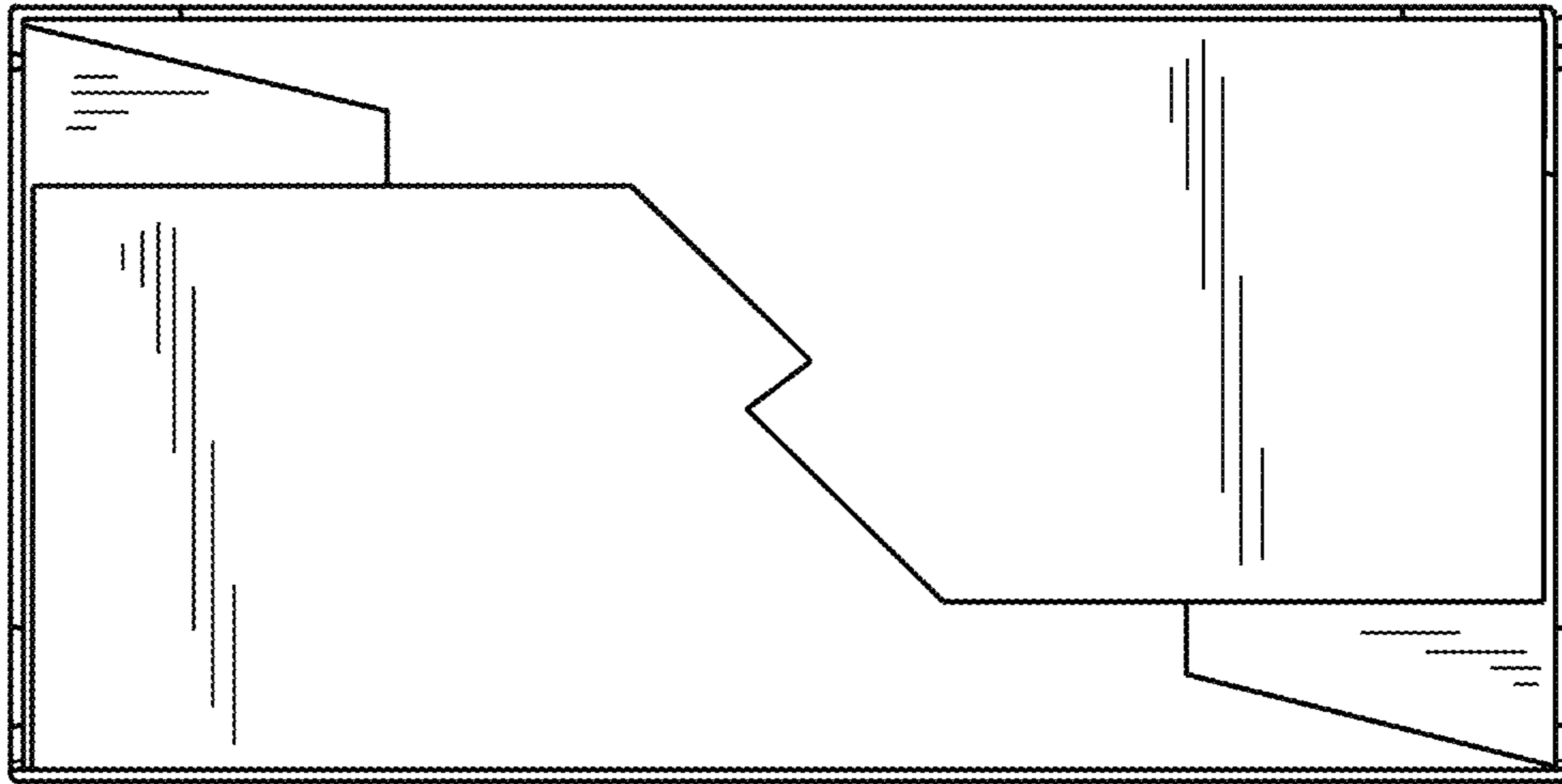

FIG. 6

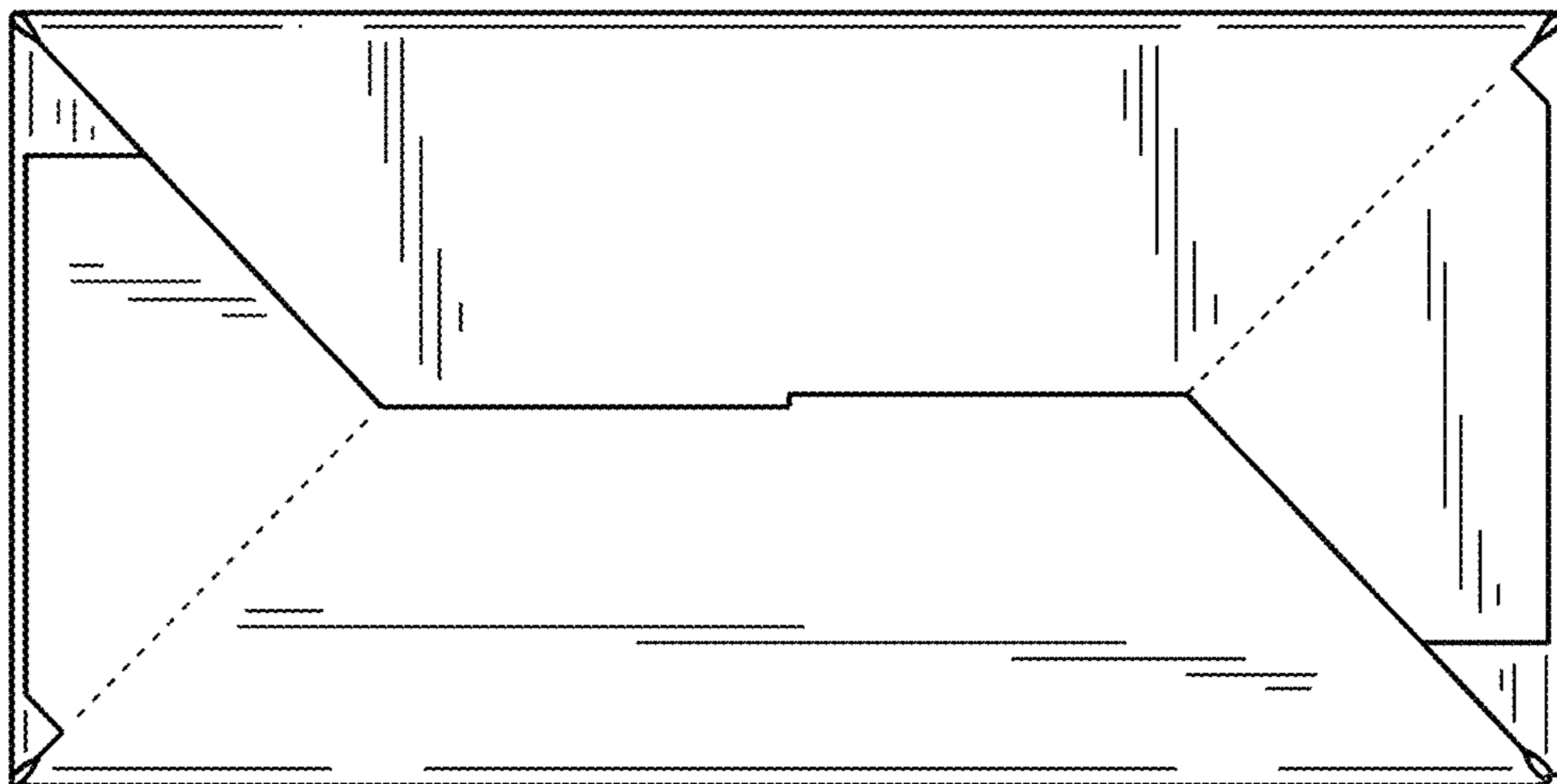

FIG. 7

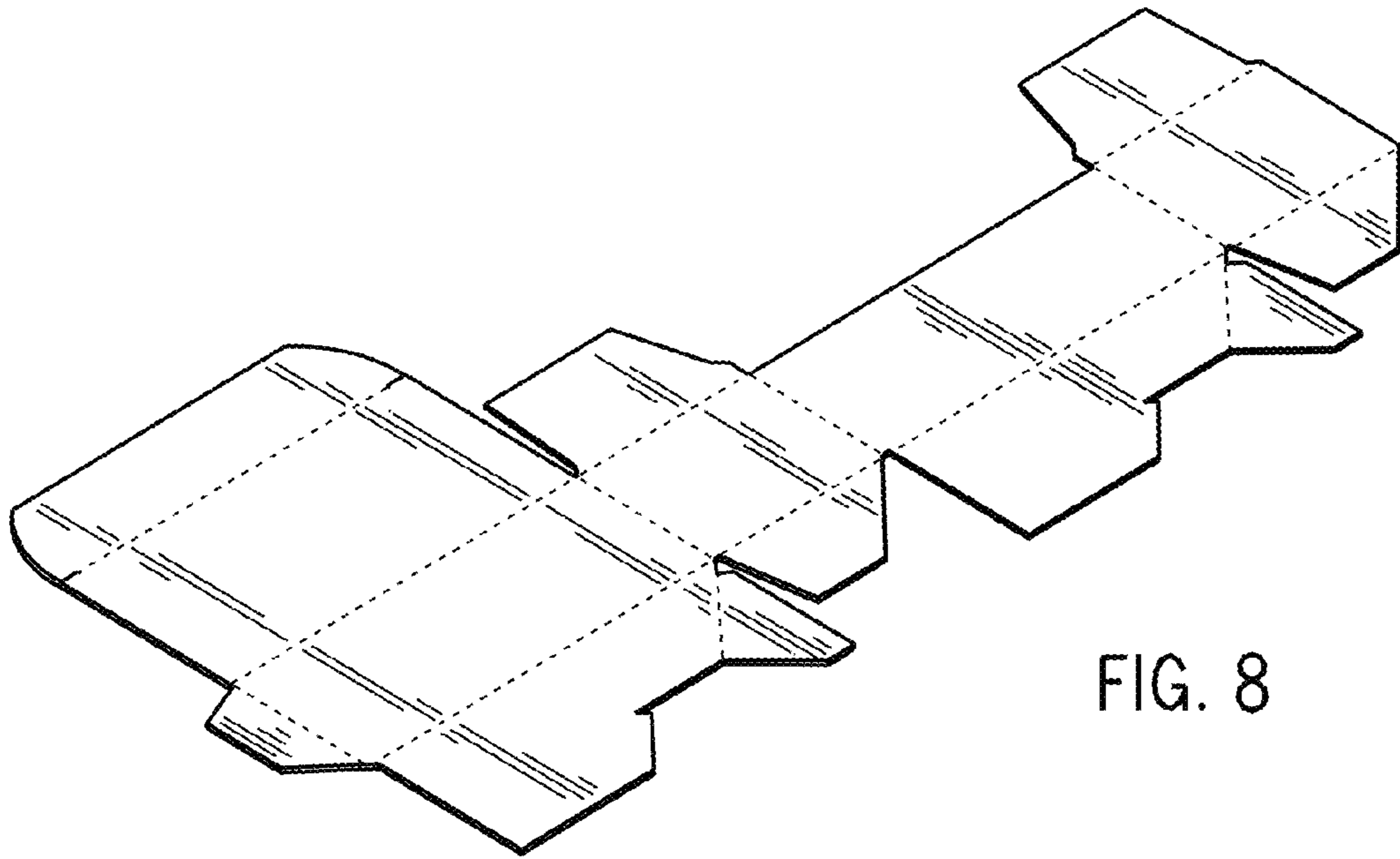

FIG. 8

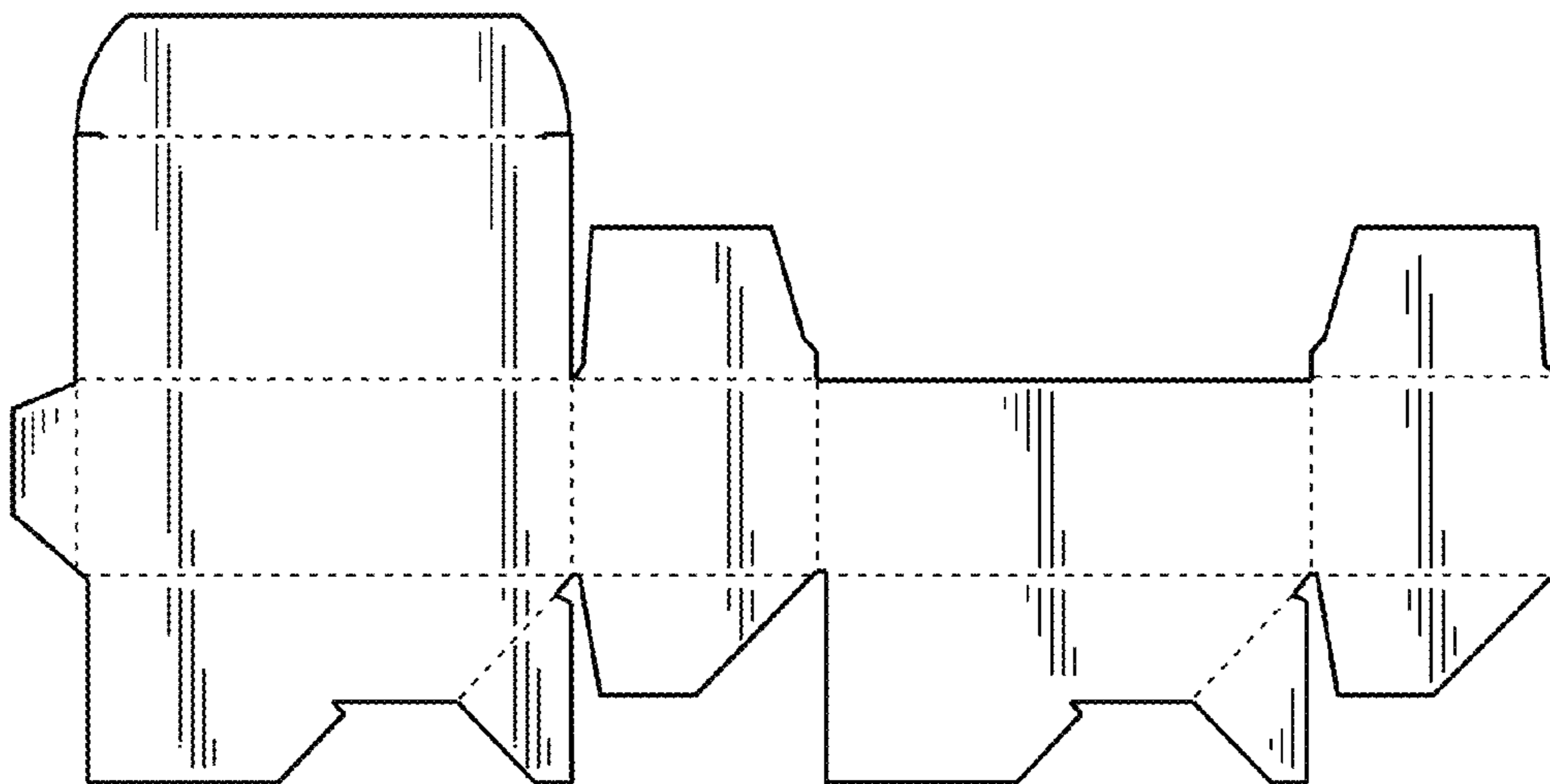

FIG. 9



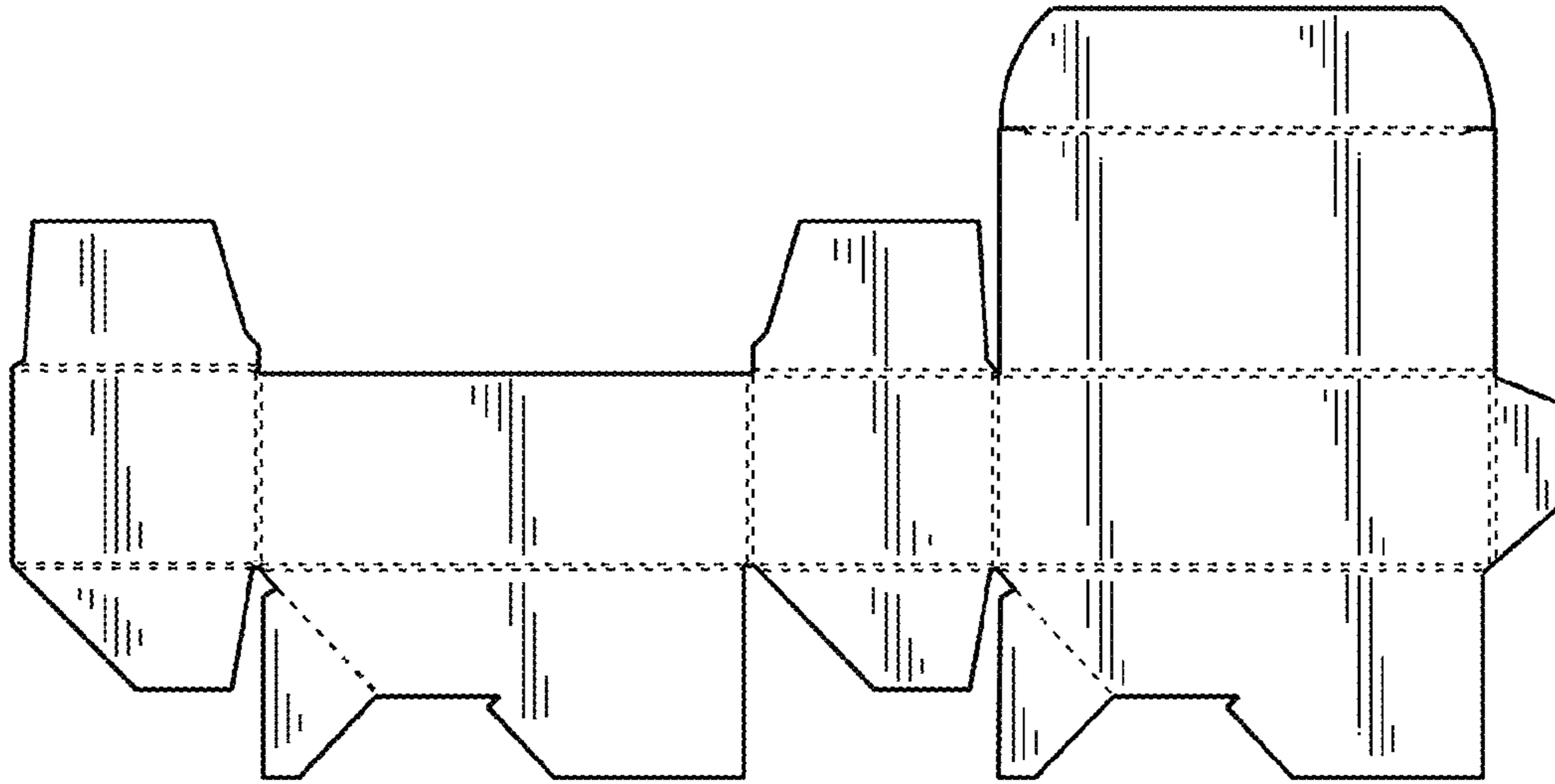

FIG. 10

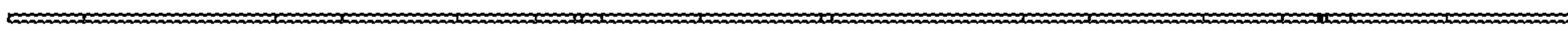

FIG. 11

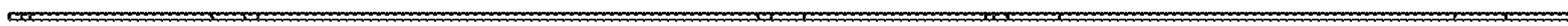

FIG. 12

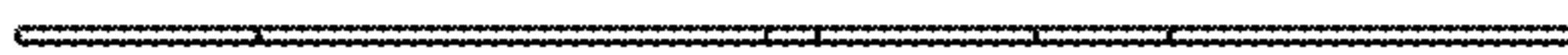

FIG. 13

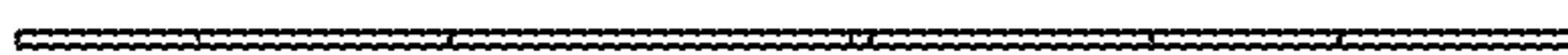

FIG. 14