



US00D745298S

(12) **United States Design Patent**
Workman et al.

(10) **Patent No.:** **US D745,298 S**

(45) **Date of Patent:** **** Dec. 15, 2015**

(54) **MODULAR SHELVING ASSEMBLY**

(71) Applicant: **L&P Property Management Company**, South Gate, CA (US)

(72) Inventors: **Bradley P. Workman**, Snellville, GA (US); **Robert W. Burkhardt**, Dacula, GA (US); **Jose M. Gamboa**, Dunwoody, GA (US); **Dennis Bazy**, Douglasville, GA (US); **Javier Castillo**, Smyrna, GA (US); **Jennifer Voelker**, Atlanta, GA (US); **William Wright**, Atlanta, GA (US); **Andrew Poole**, Decatur, GA (US)

(73) Assignee: **L&P PROPERTY MANAGEMENT COMPANY**, South Gate, CA (US)

(**) Term: **14 Years**

(21) Appl. No.: **29/483,800**

(22) Filed: **Mar. 3, 2014**

(51) **LOC (10) Cl.** **06-06**

(52) **U.S. Cl.**
USPC **D6/705**

(58) **Field of Classification Search**
USPC D6/396-397, 436, 411, 449, 455-469, D6/675, 675.1, 705, 705.1; 108/59, 91, 92, 108/93-94; 211/13.1, 85.1, 85.2, 85.4, 70, 211/78, 107, 131.1, 133.2, 163, 164, 181.1, 211/182

CPC A47B 46/005; A47B 57/10; A47B 46/00
See application file for complete search history.

(56) **References Cited**

U.S. PATENT DOCUMENTS

1,691,621	A *	11/1928	Young	280/79.3
2,385,559	A *	9/1945	Wenthe	211/189
D206,481	S *	12/1966	McKay	D34/19
3,527,359	A *	9/1970	Ambertson	211/71.01
3,610,429	A *	10/1971	MacKay	211/126.15
3,712,697	A *	1/1973	Kelley et al.	312/297
3,868,123	A *	2/1975	Berg et al.	280/79.2
3,963,125	A *	6/1976	Baggott	211/126.15

D246,773	S *	12/1977	Bladis	D34/21
D322,875	S *	12/1991	Kelley	D34/21
D408,953	S *	4/1999	Golichowski et al.	D34/21
D478,739	S *	8/2003	Sparkowski	D6/465
D479,925	S *	9/2003	Hsieh et al.	D6/479
D493,047	S *	7/2004	Moon et al.	D6/479
D497,738	S *	11/2004	Sparkowski	D6/465
D525,934	S *	8/2006	Panasewicz et al.	D12/424
D534,376	S *	1/2007	Sparkowski	D6/468
D536,659	S	2/2007	Panasewicz et al.		
D549,154	S	8/2007	Panasewicz et al.		
D553,555	S	10/2007	Panasewicz et al.		
D565,324	S *	4/2008	Sparkowski	D6/465
D573,369	S *	7/2008	Sparkowski	D6/463
7,641,253	B2	1/2010	Steiger et al.		
7,784,885	B2	8/2010	Steiger et al.		
D655,107	S *	3/2012	Clark et al.	D6/476
D657,591	S *	4/2012	Sanchez	D6/479
2005/0127802	A1	6/2005	Chen		
2005/0225108	A1	10/2005	Panasewicz et al.		
2007/0069542	A1	3/2007	Steiger et al.		
2007/0145865	A1	6/2007	Richter		
2012/0126576	A1	5/2012	Pencak et al.		

* cited by examiner

OTHER PUBLICATIONS

International Search Report and Written Opinion of the International Search Authority, received in International Patent Application No. PCT/US2014/021092, mailed Jun. 16, 2014.

Primary Examiner — Kelley Donnelly

(74) *Attorney, Agent, or Firm* — Michael Best & Friedrich LLP

(57) **CLAIM**

We claim the ornamental design for a modular shelving assembly, as shown and described.

DESCRIPTION

FIG. 1 is a front perspective view of a modular shelving assembly in accordance with a first embodiment of the present invention.

FIG. 2 is a front view of the modular shelving assembly of FIG. 1.

FIG. 3 is a rear view of the modular shelving assembly of FIG. 1.

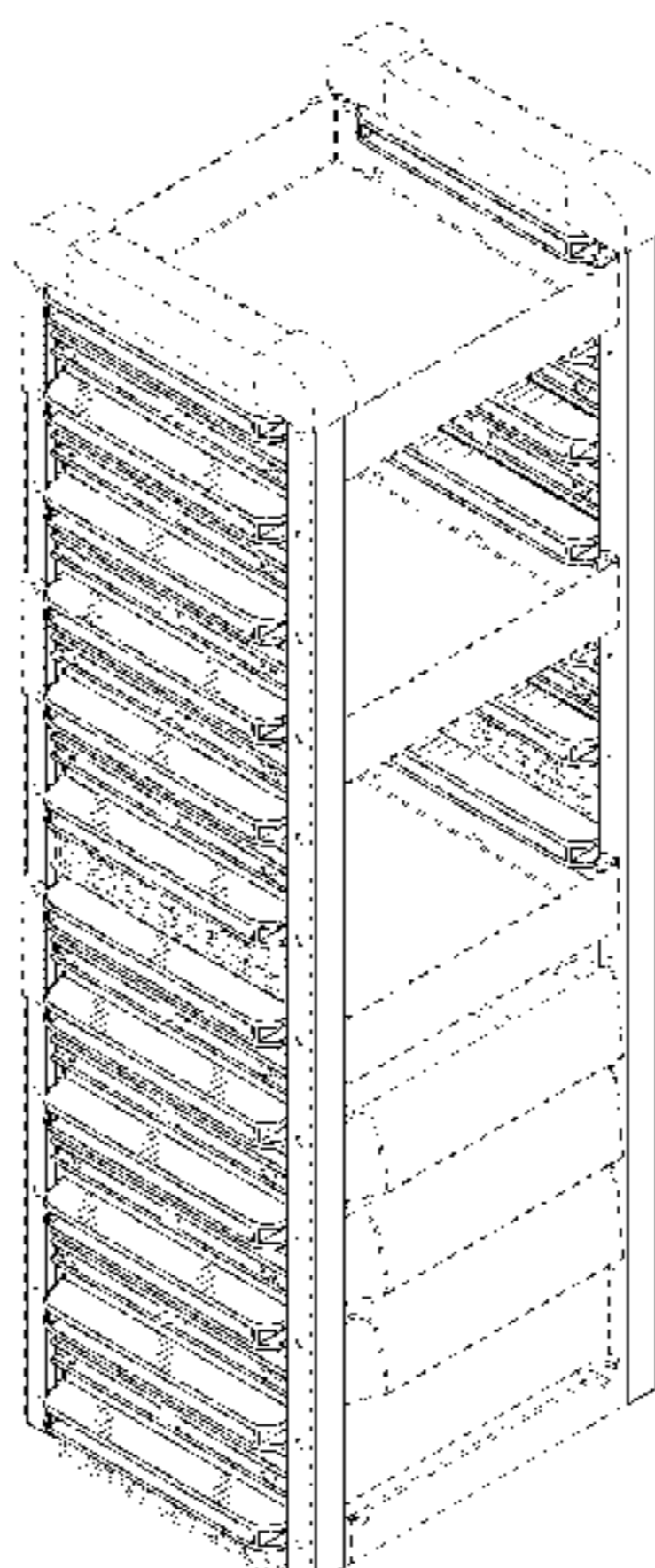

FIG. 4 is a left side view of the modular shelving assembly of FIG. 1.

FIG. 5 is a right side view of the modular shelving assembly of FIG. 1.

FIG. 6 is a top view of the modular shelving assembly of FIG. 1.

FIG. 7 is a bottom view of the modular shelving assembly of FIG. 1.

FIG. 8 is a front perspective view of a modular shelving assembly in accordance with a second embodiment of the present invention.

FIG. 9 is a front view of the modular shelving assembly of FIG. 8.

FIG. 10 is a rear view of the modular shelving assembly of FIG. 8.

FIG. 11 is a left side view of the modular shelving assembly of FIG. 8.

FIG. 12 is a right side view of the modular shelving assembly of FIG. 8.

FIG. 13 is a top view of the modular shelving assembly of FIG. 8.

FIG. 14 is a bottom view of the modular shelving assembly of FIG. 8.

FIG. 15 is a front perspective view of a modular shelving assembly in accordance with a third embodiment of the present invention.

FIG. 16 is a front view of the modular shelving assembly of FIG. 15.

FIG. 17 is a rear view of the modular shelving assembly of FIG. 15.

FIG. 18 is a left side view of the modular shelving assembly of FIG. 15.

FIG. 19 is a right side view of the modular shelving assembly of FIG. 15.

FIG. 20 is a top view of the modular shelving assembly of FIG. 15.

FIG. 21 is a bottom view of the modular shelving assembly of FIG. 15.

FIG. 22 is a front perspective view of a modular shelving assembly in accordance with a fourth embodiment of the present invention.

FIG. 23 is a front view of the modular shelving assembly of FIG. 22.

FIG. 24 is a rear view of the modular shelving assembly of FIG. 22.

FIG. 25 is a left side view of the modular shelving assembly of FIG. 22.

FIG. 26 is a right side view of the modular shelving assembly of FIG. 22.

FIG. 27 is a top view of the modular shelving assembly of FIG. 22.

FIG. 28 is a bottom view of the modular shelving assembly of FIG. 22.

FIG. 29 is a front perspective view of a modular shelving assembly in accordance with a fifth embodiment of the present invention.

FIG. 30 is a front view of the modular shelving assembly of FIG. 29.

FIG. 31 is a rear view of the modular shelving assembly of FIG. 29.

FIG. 32 is a left side view of the modular shelving assembly of FIG. 29.

FIG. 33 is a right side view of the modular shelving assembly of FIG. 29.

FIG. 34 is a top view of the modular shelving assembly of FIG. 29.

FIG. 35 is a bottom view of the modular shelving assembly of FIG. 29.

FIG. 36 is a front perspective view of a modular shelving assembly in accordance with a sixth embodiment of the present invention.

FIG. 37 is a front view of the modular shelving assembly of FIG. 36.

FIG. 38 is a rear view of the modular shelving assembly of FIG. 36.

FIG. 39 is a left side view of the modular shelving assembly of FIG. 36.

FIG. 40 is a right side view of the modular shelving assembly of FIG. 36.

FIG. 41 is a top view of the modular shelving assembly of FIG. 36.

FIG. 42 is a bottom view of the modular shelving assembly of FIG. 36.

FIG. 43 is a front perspective view of a modular shelving assembly in accordance with a seventh embodiment of the present invention.

FIG. 44 is a front view of the modular shelving assembly of FIG. 43.

FIG. 45 is a rear view of the modular shelving assembly of FIG. 43.

FIG. 46 is a left side view of the modular shelving assembly of FIG. 43.

FIG. 47 is a right side view of the modular shelving assembly of FIG. 43.

FIG. 48 is a top view of the modular shelving assembly of FIG. 43.

FIG. 49 is a bottom view of the modular shelving assembly of FIG. 43.

FIG. 50 is a front perspective view of a modular shelving assembly in accordance with an eighth embodiment of the present invention.

FIG. 51 is a front view of the modular shelving assembly of FIG. 50.

FIG. 52 is a rear view of the modular shelving assembly of FIG. 50.

FIG. 53 is a left side view of the modular shelving assembly of FIG. 50.

FIG. 54 is a right side view of the modular shelving assembly of FIG. 50.

FIG. 55 is a top view of the modular shelving assembly of FIG. 50.

FIG. 56 is a bottom view of the modular shelving assembly of FIG. 50.

FIG. 57 is a front perspective view of a modular shelving assembly in accordance with a ninth embodiment of the present invention.

FIG. 58 is a front view of the modular shelving assembly of FIG. 57.

FIG. 59 is a rear view of the modular shelving assembly of FIG. 57.

FIG. 60 is a left side view of the modular shelving assembly of FIG. 57.

FIG. 61 is a right side view of the modular shelving assembly of FIG. 57.

FIG. 62 is a top view of the modular shelving assembly of FIG. 57; and,

FIG. 63 is a bottom view of the modular shelving assembly of FIG. 57.

The portions of the modular shelving assembly shown in broken lines are included for the purpose of illustrating environment and form no part of the claimed design. The portions of the modular shelving system shown in broken lines having

unequal length segments illustrate the boundary of the claimed design and form no part of the claimed design.

1 Claim, 42 Drawing Sheets

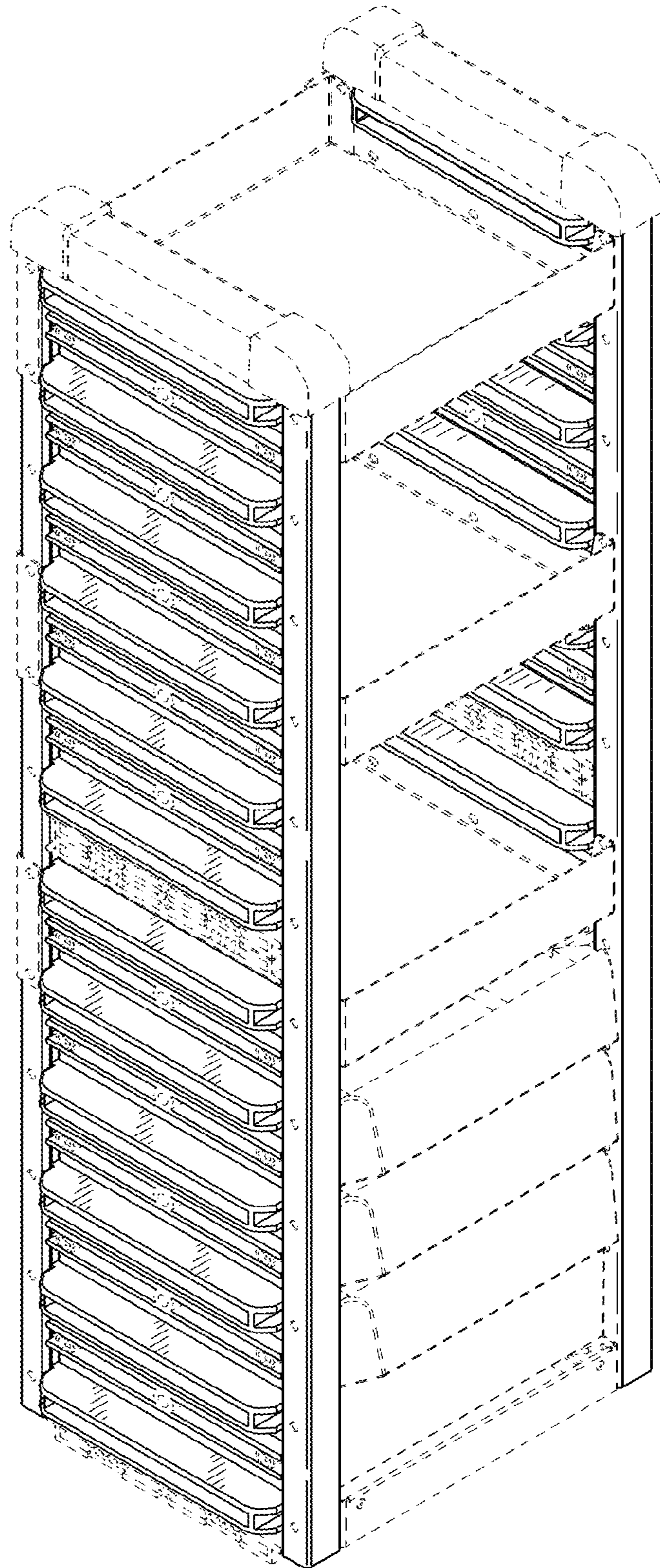

FIG. 1

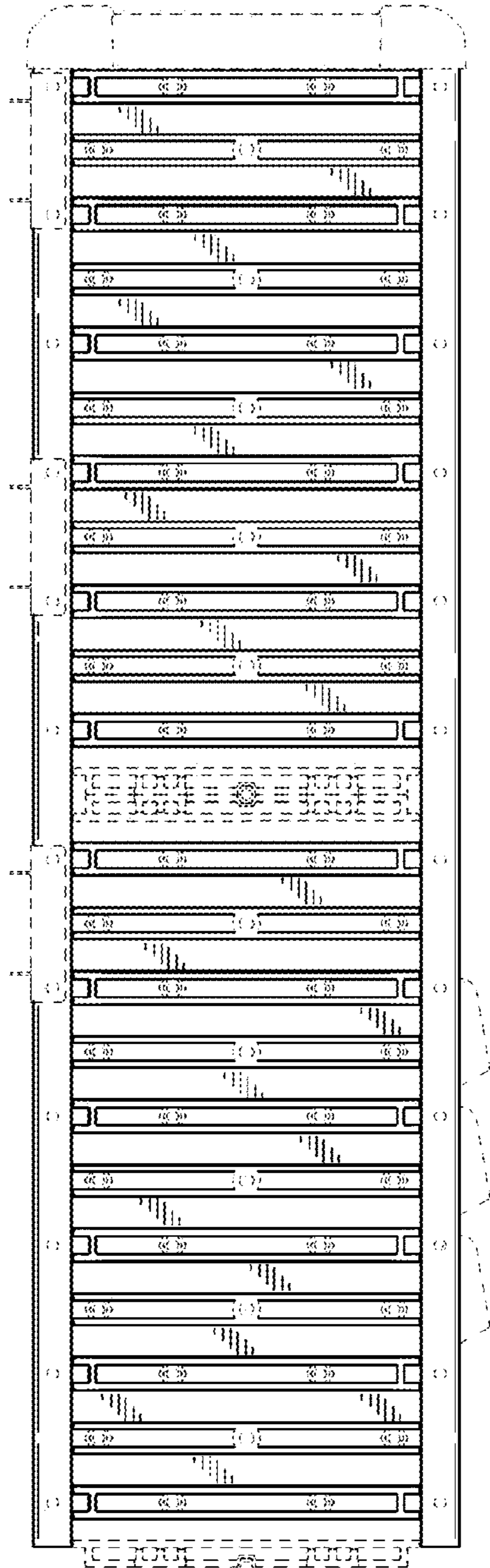

FIG. 2

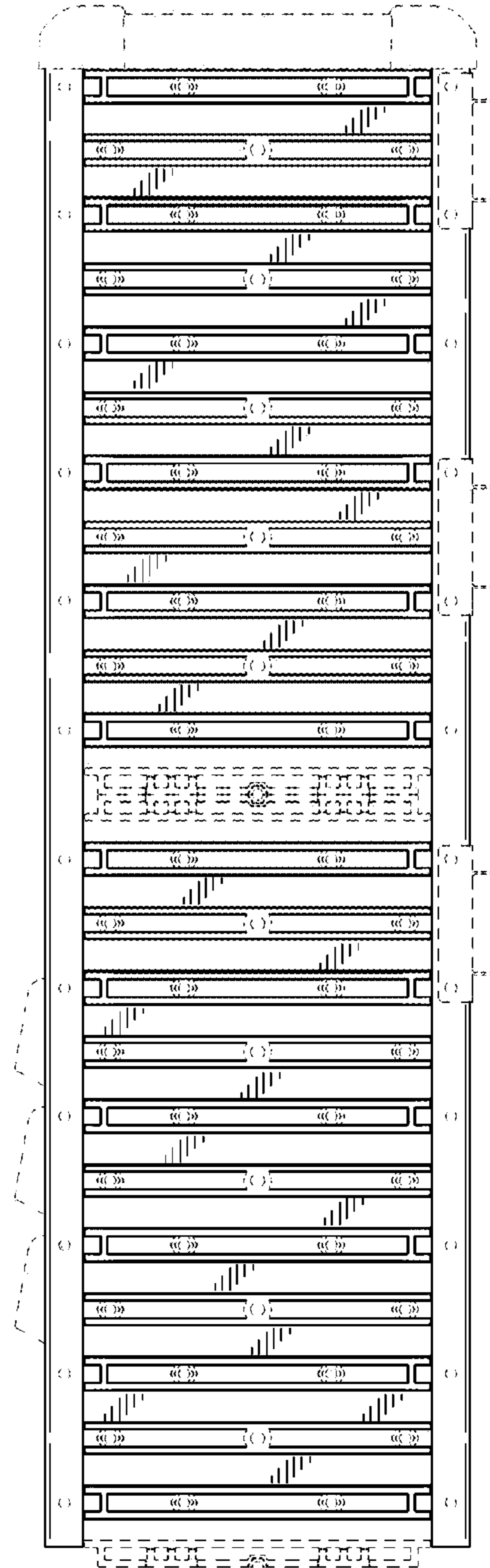

FIG. 3

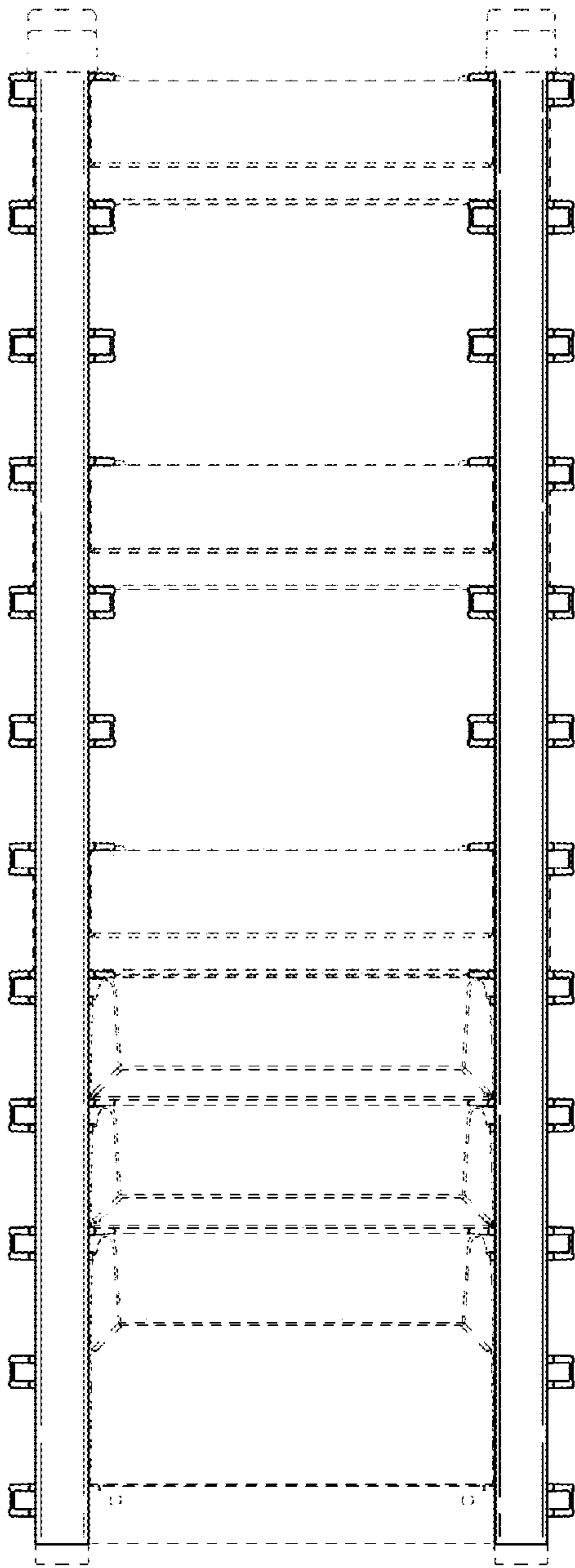

FIG. 4

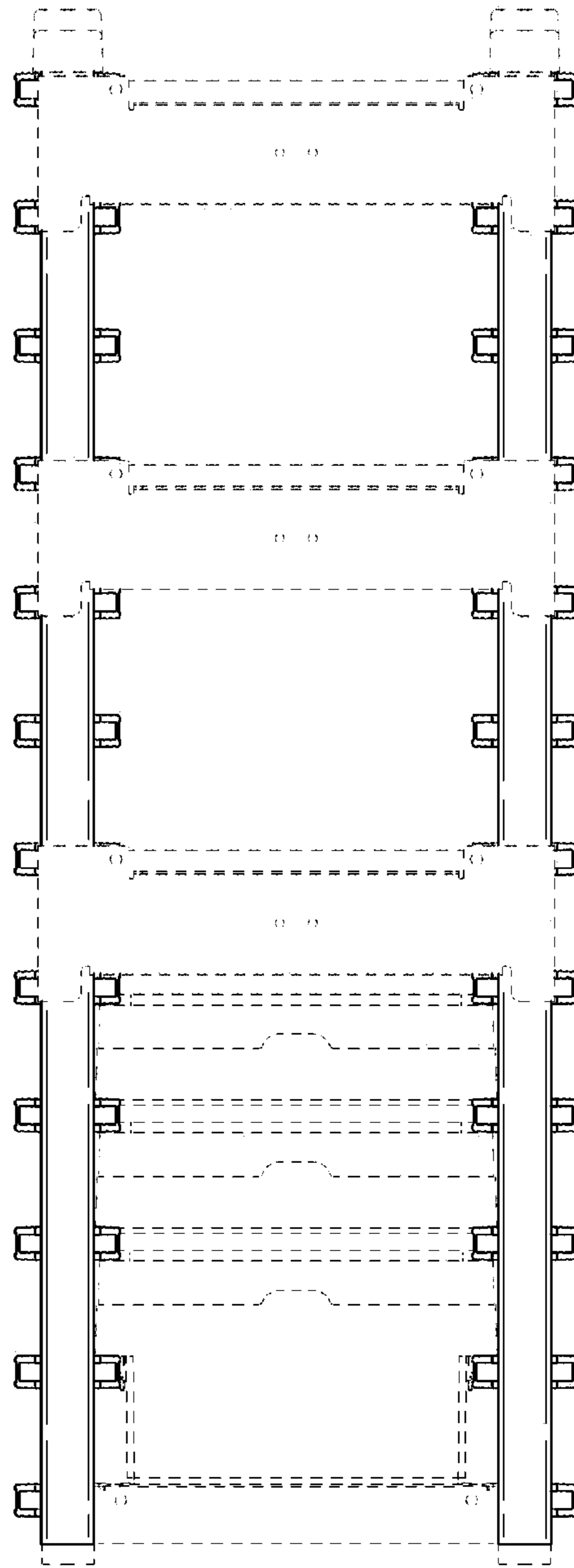

FIG. 5

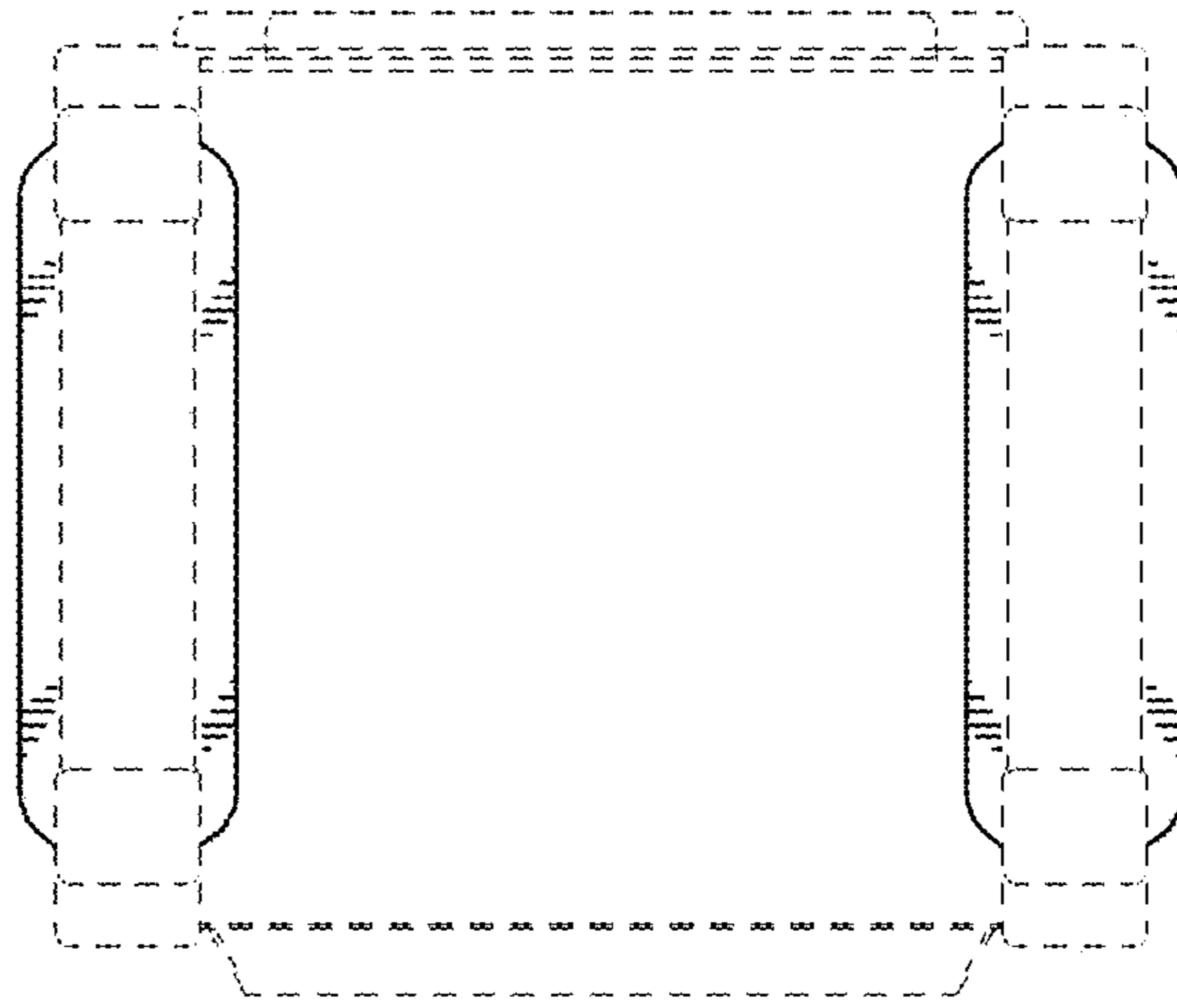

FIG. 6

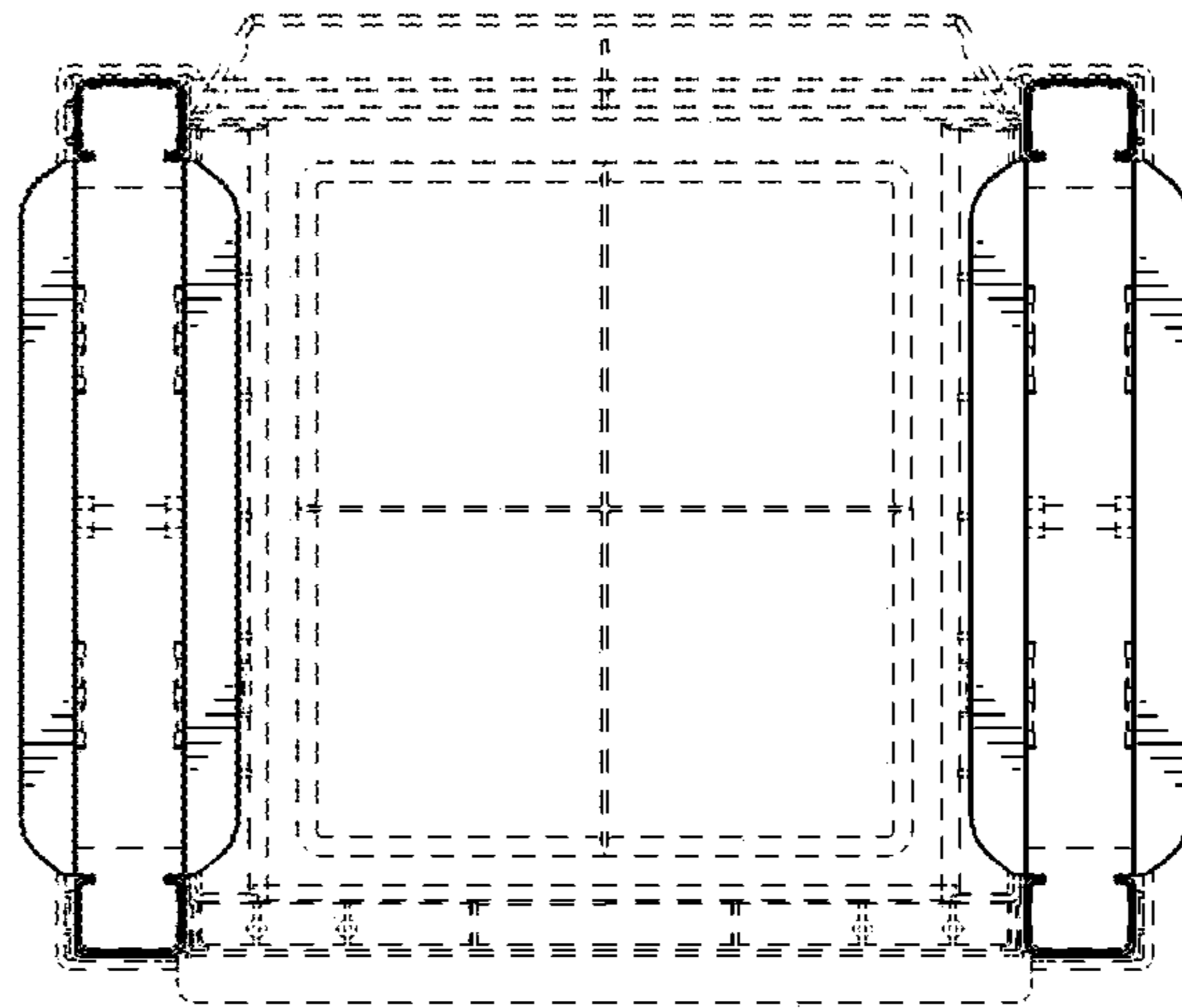

FIG. 7

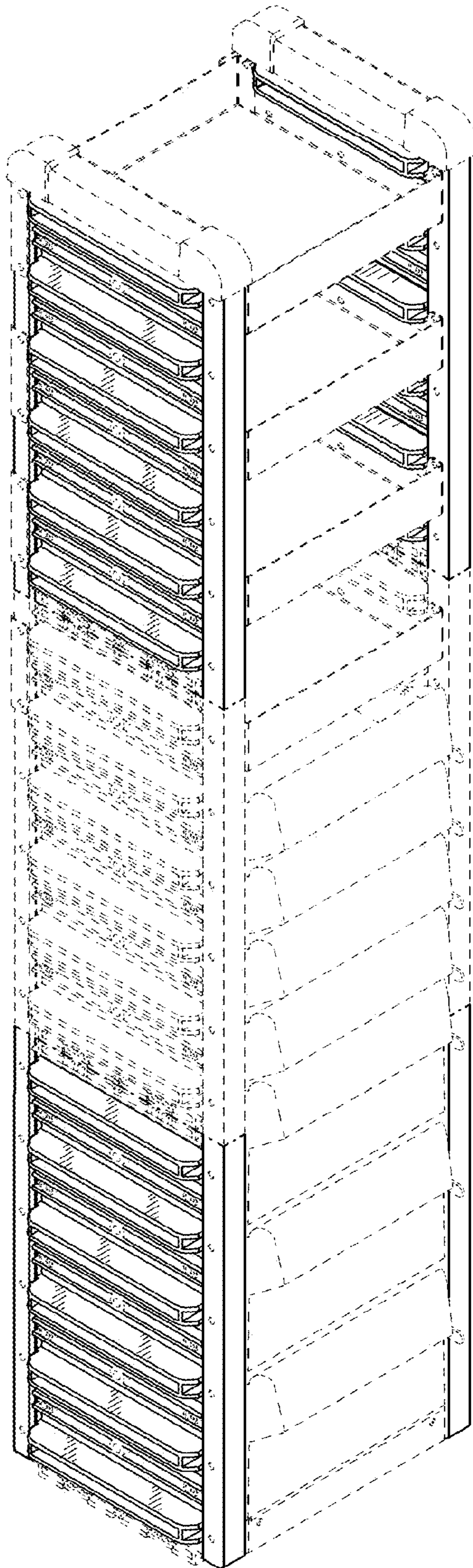

FIG. 8

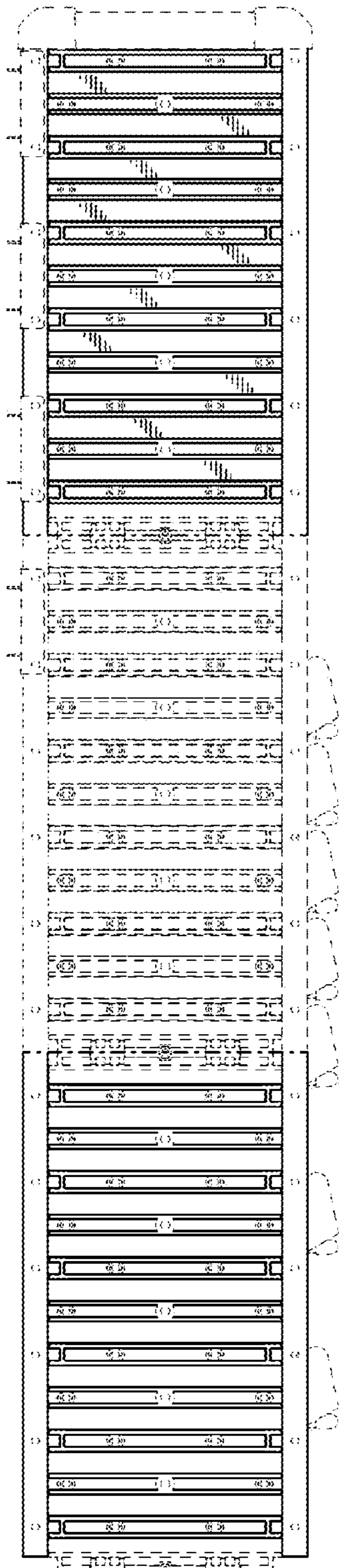

FIG. 9

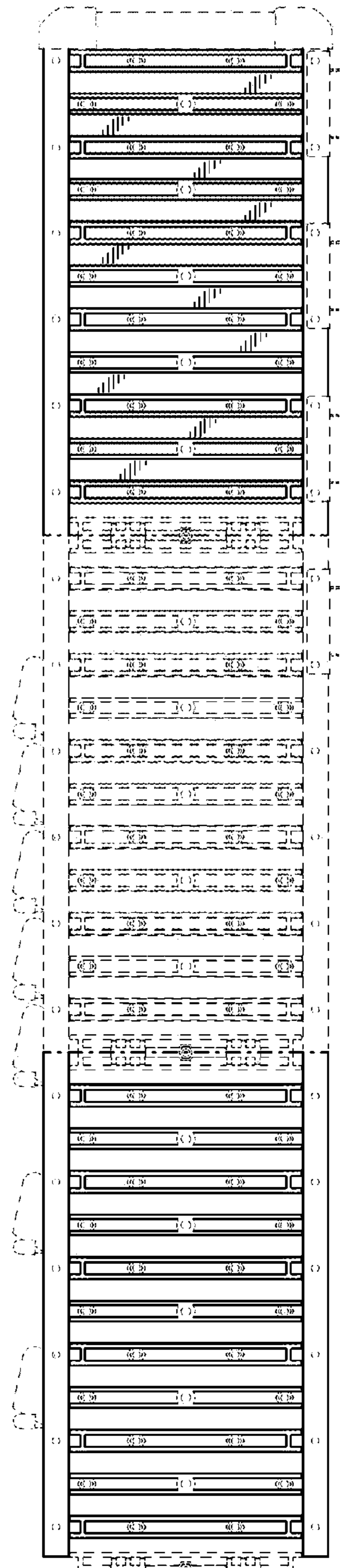

FIG. 10

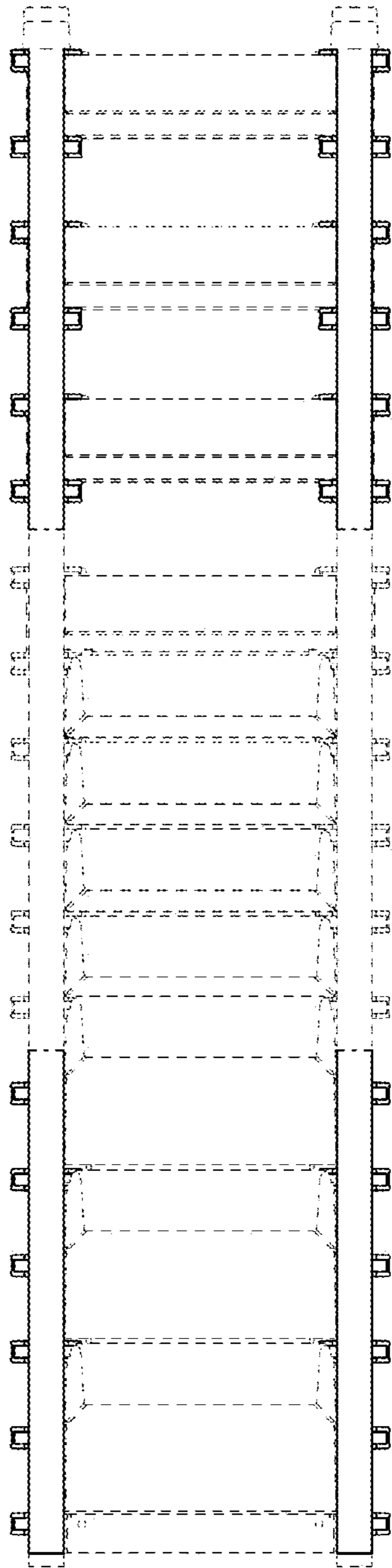

FIG. 11

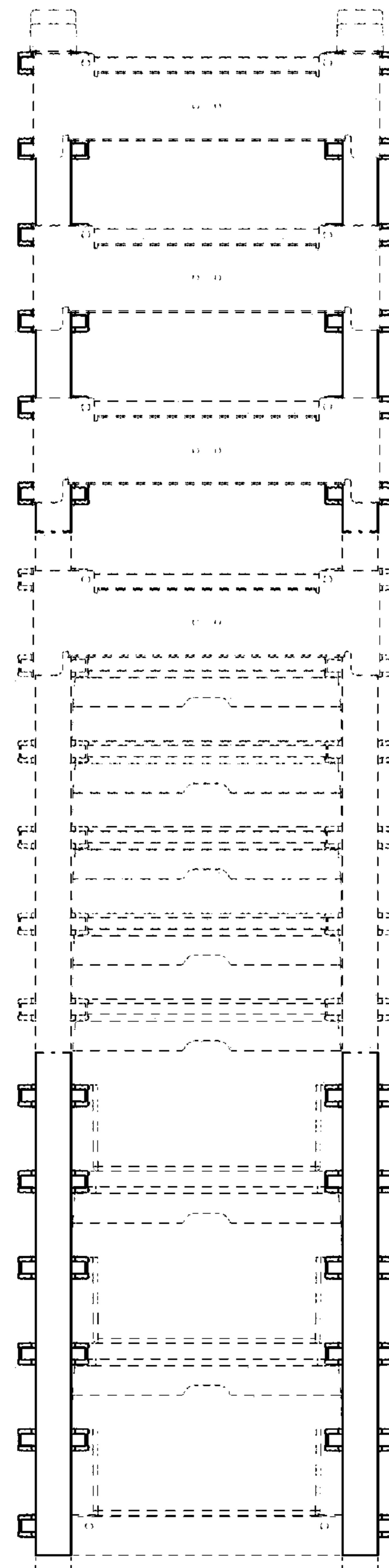

FIG. 12

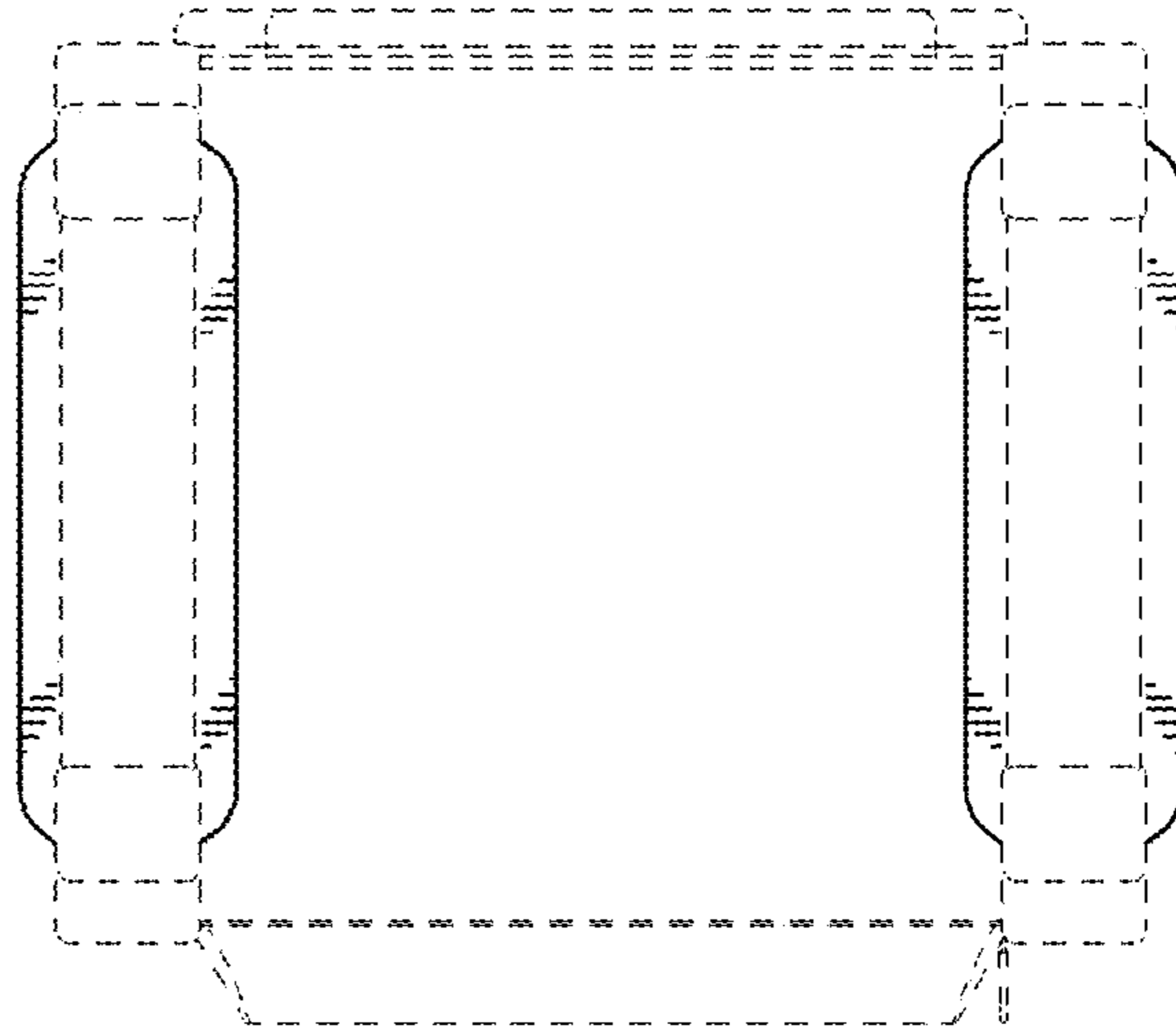

FIG. 13

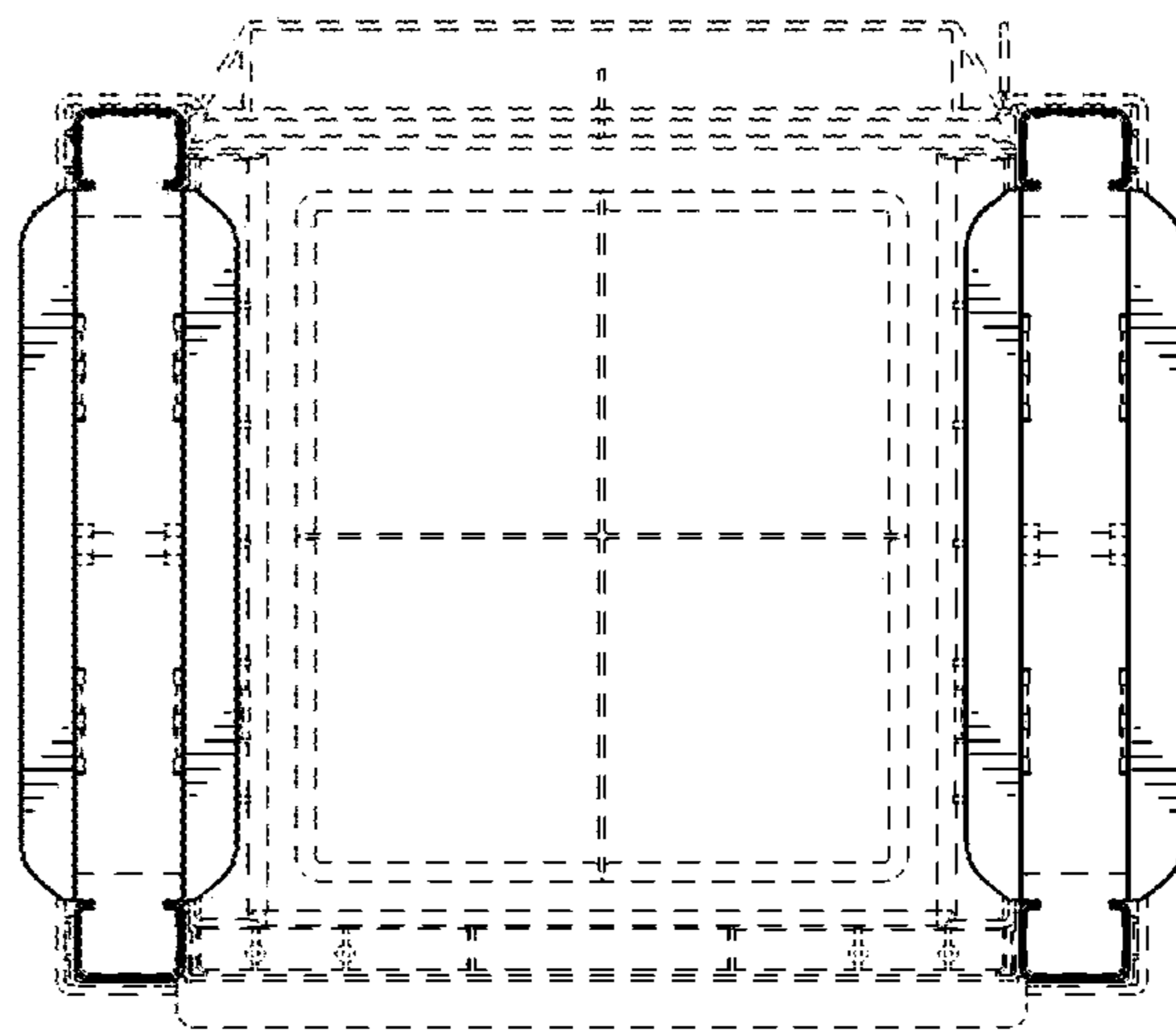

FIG. 14

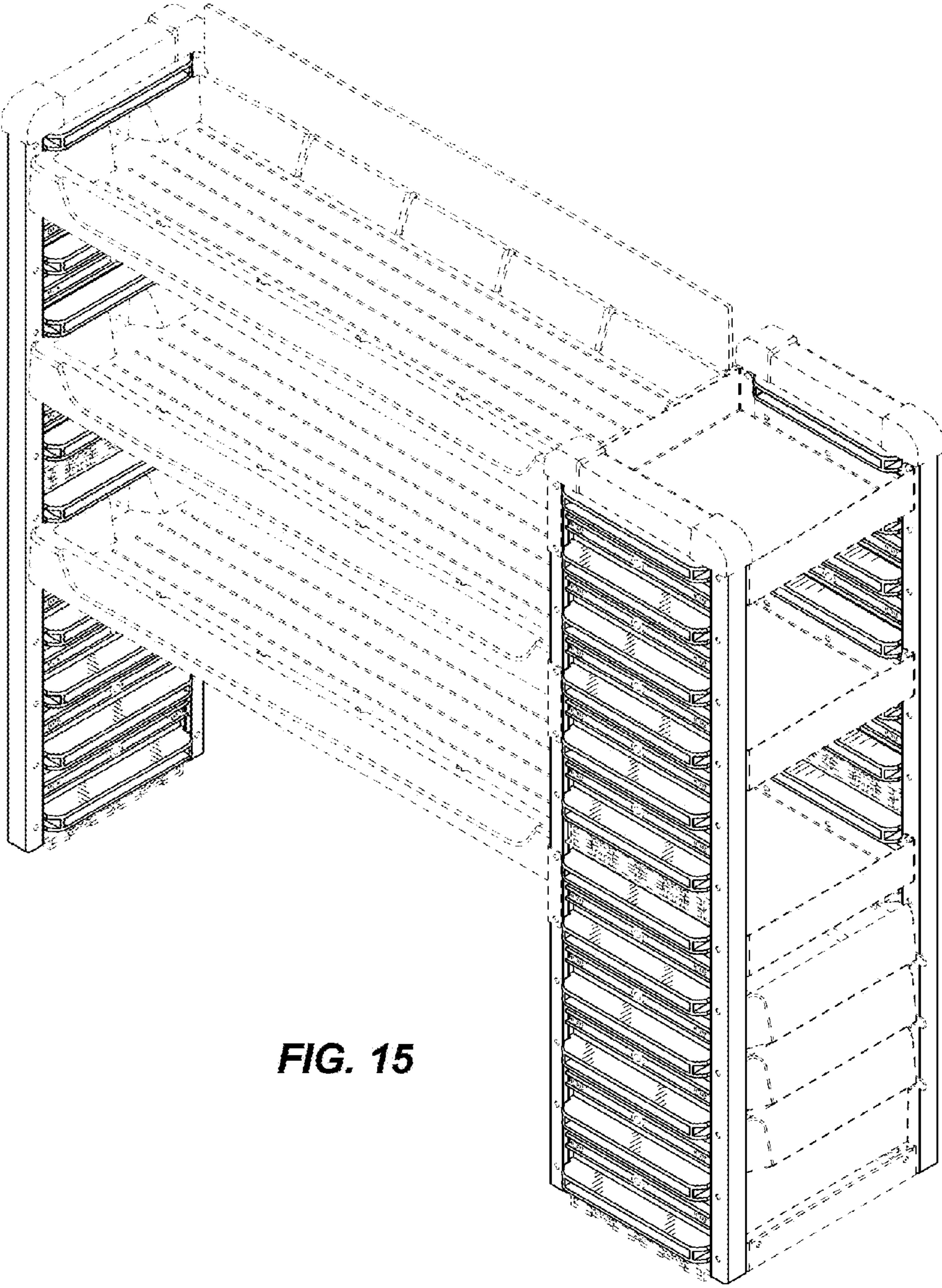

FIG. 15

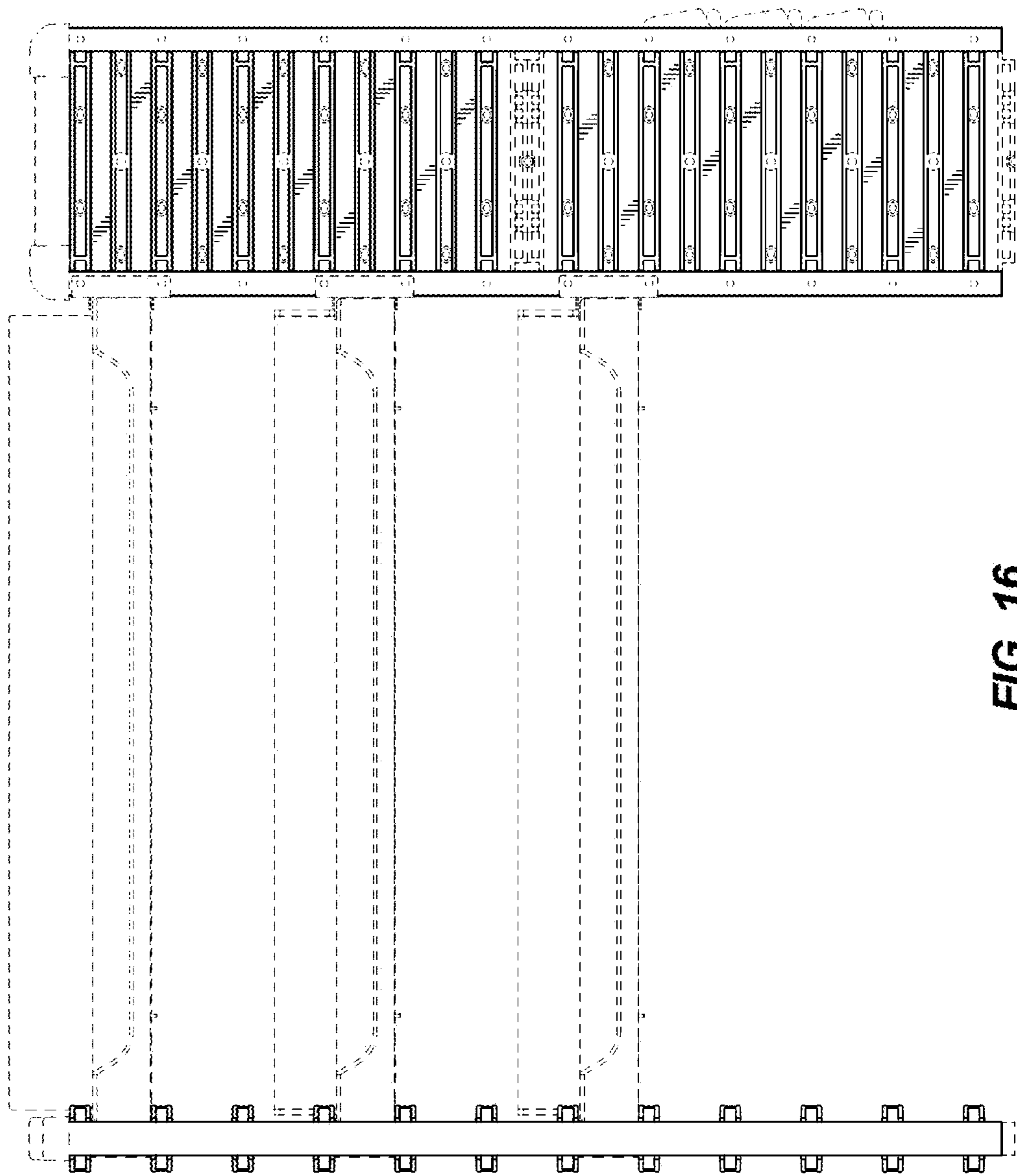

FIG. 16

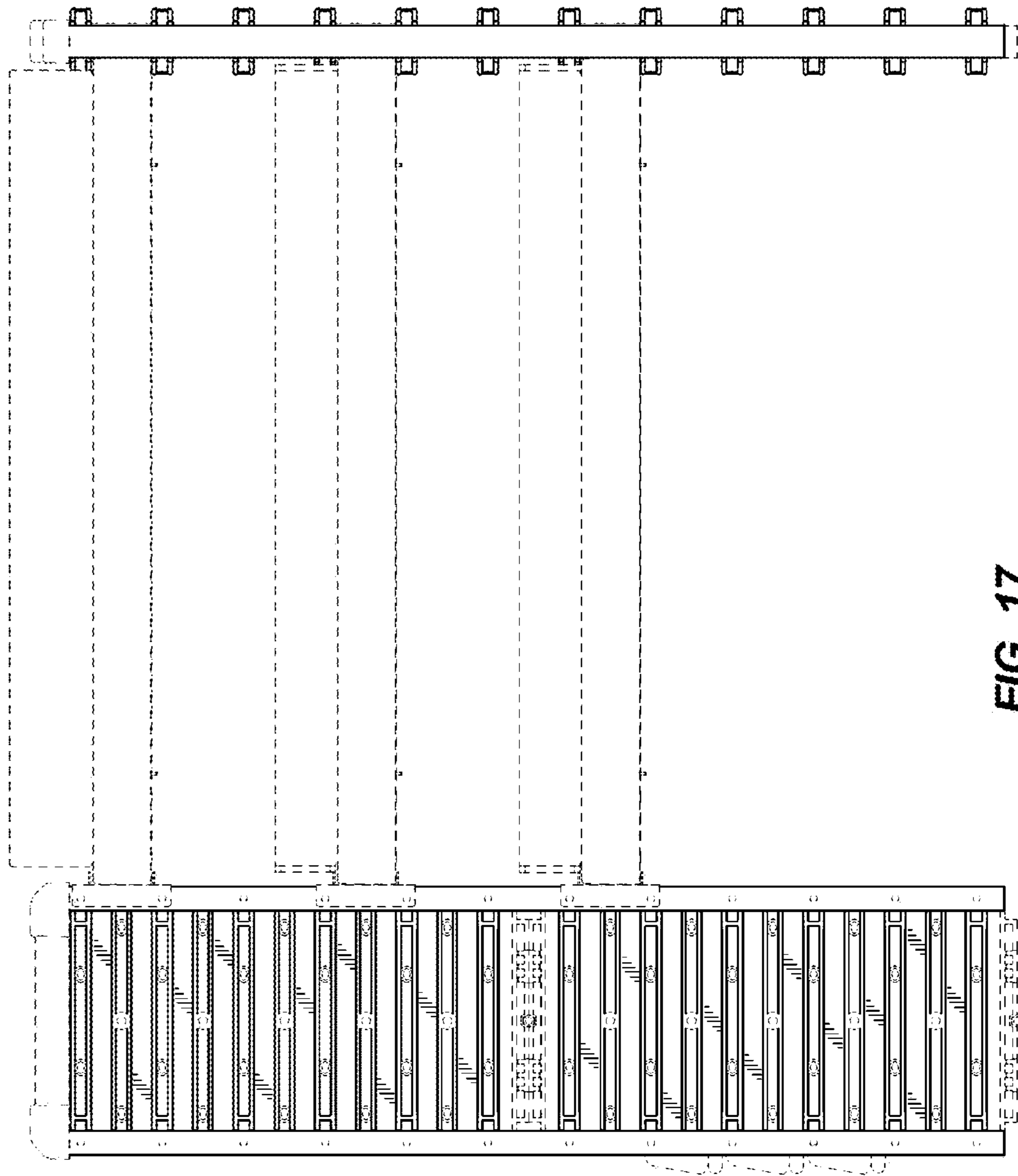

FIG. 17

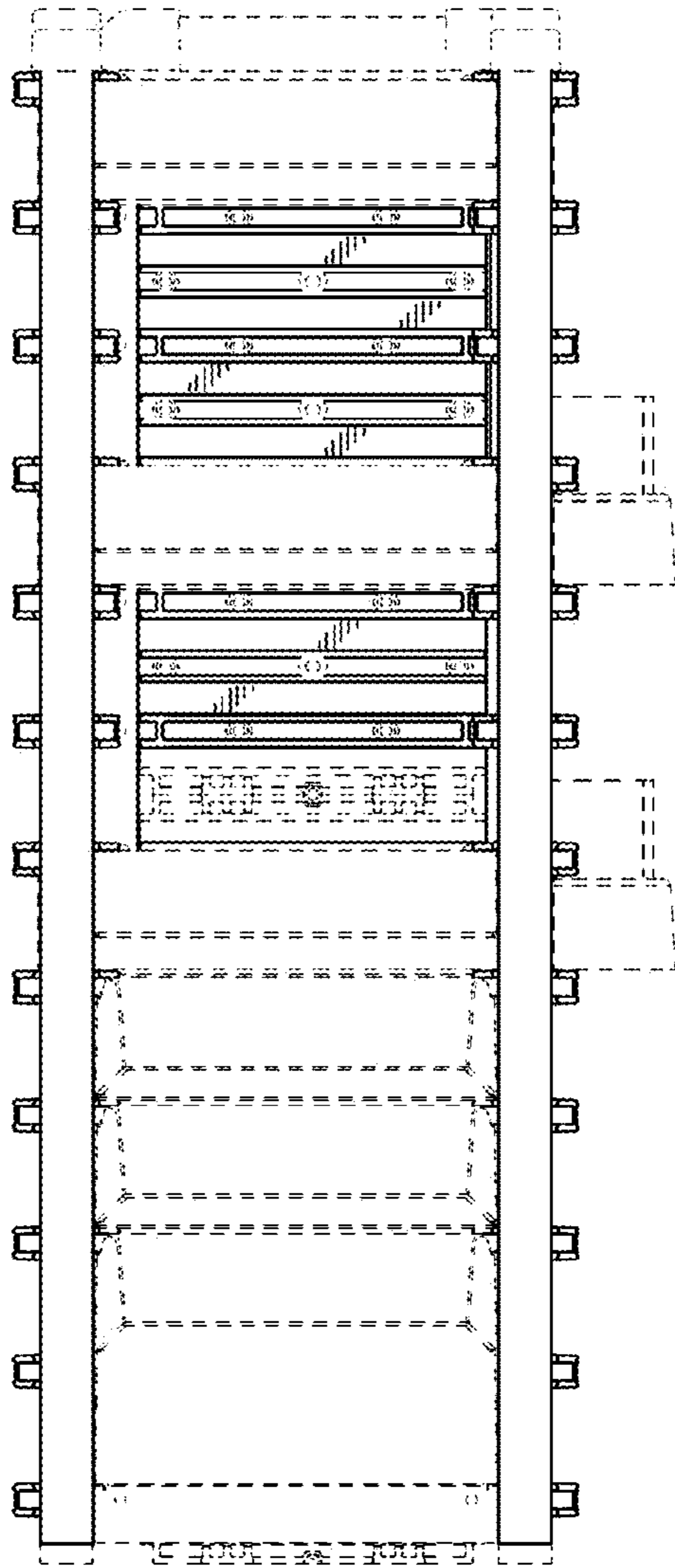

FIG. 18

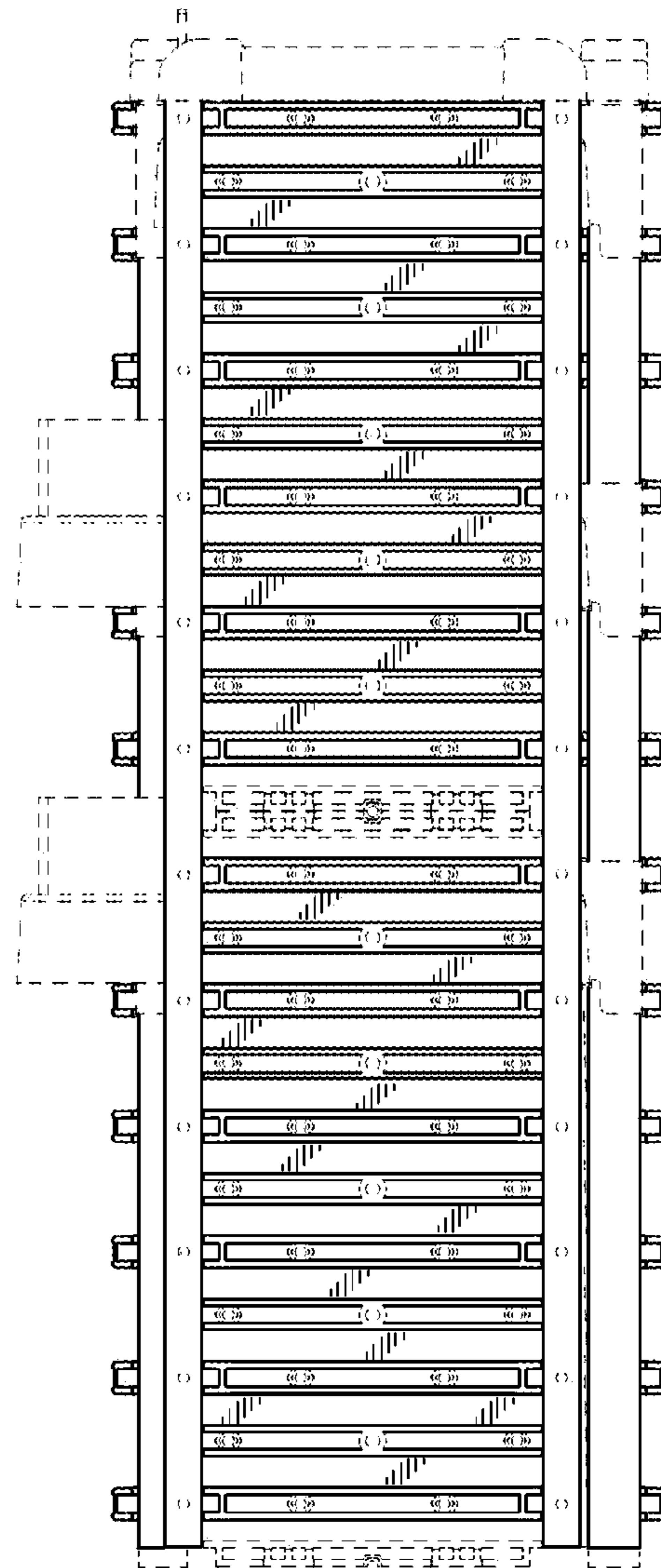

FIG. 19

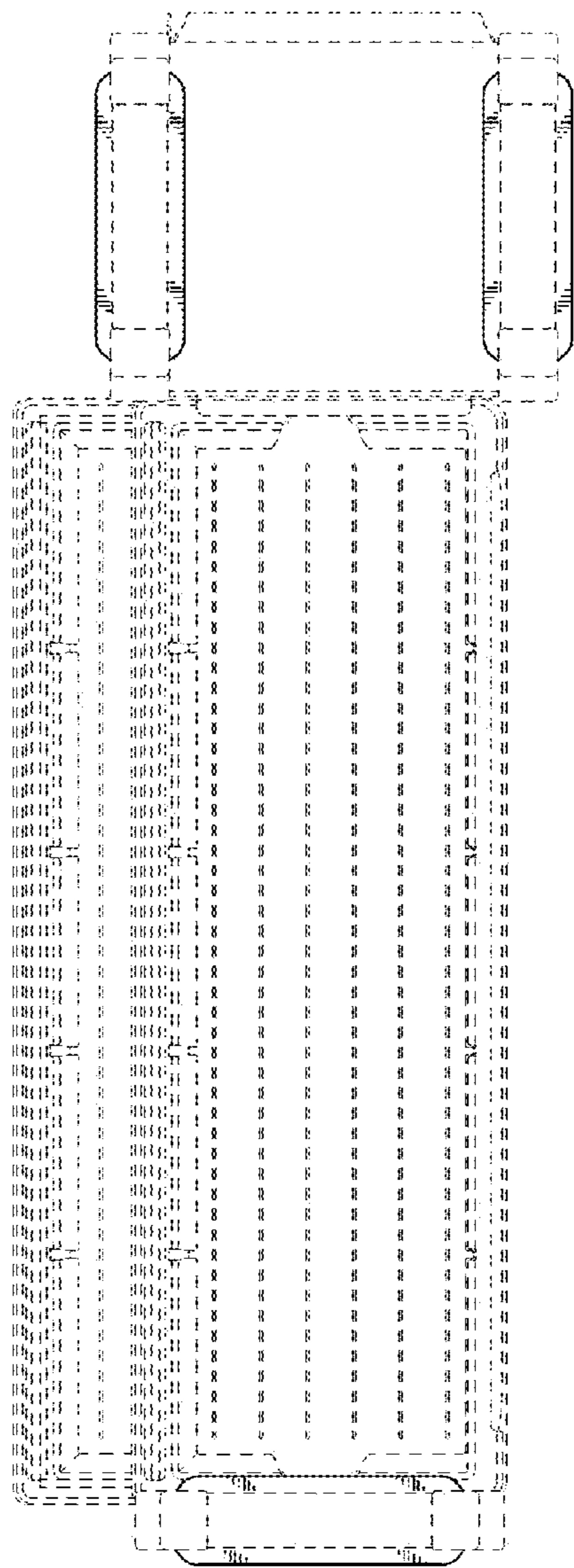

FIG. 20

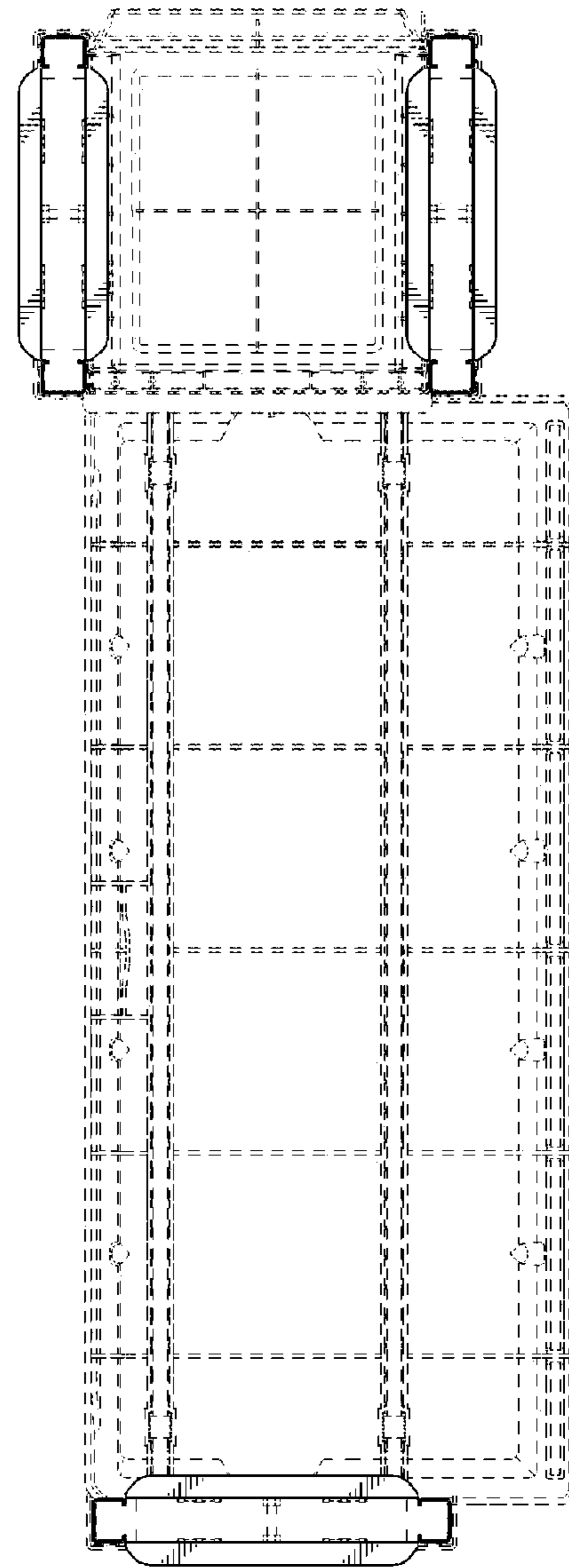

FIG. 21

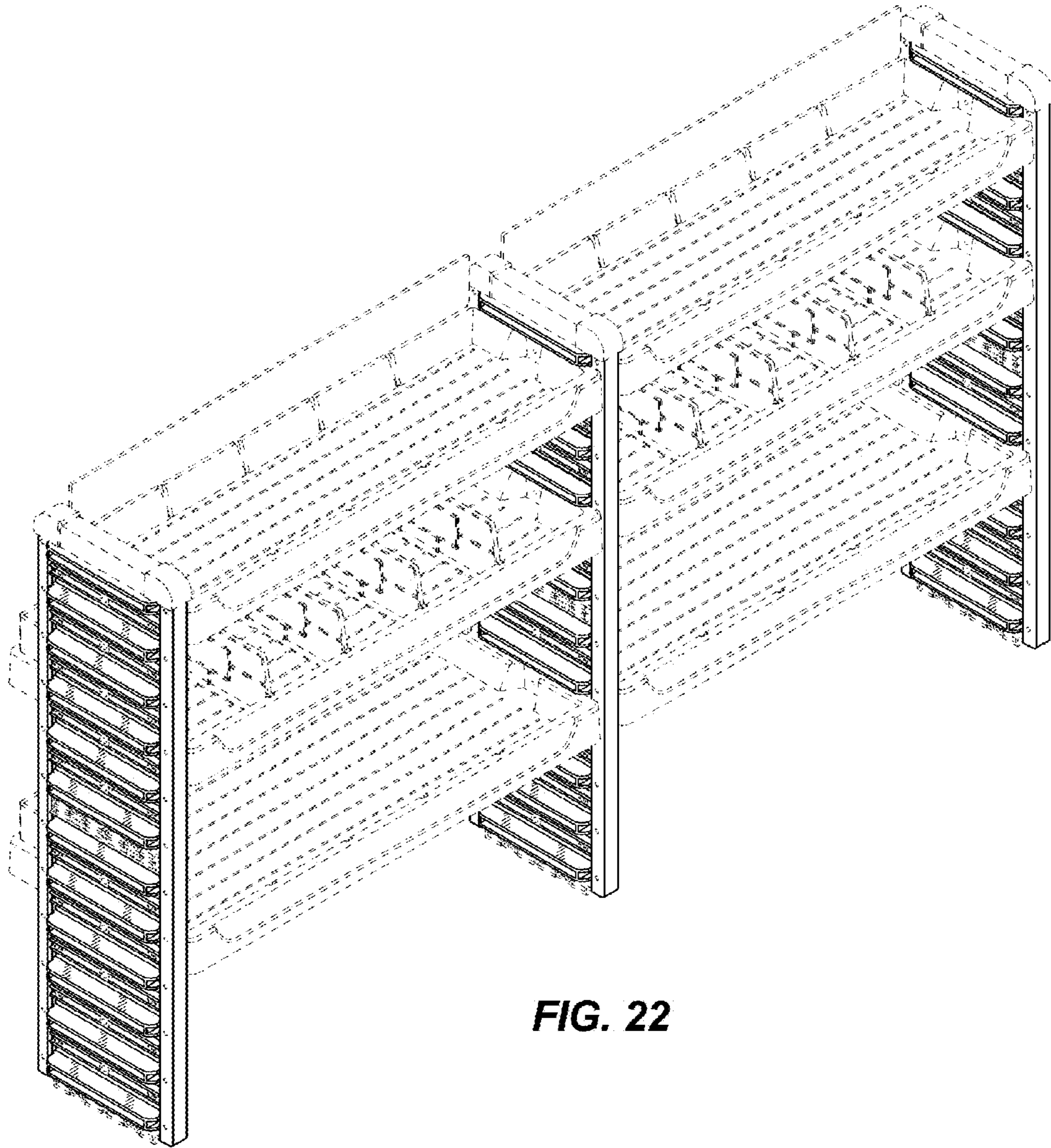

FIG. 22

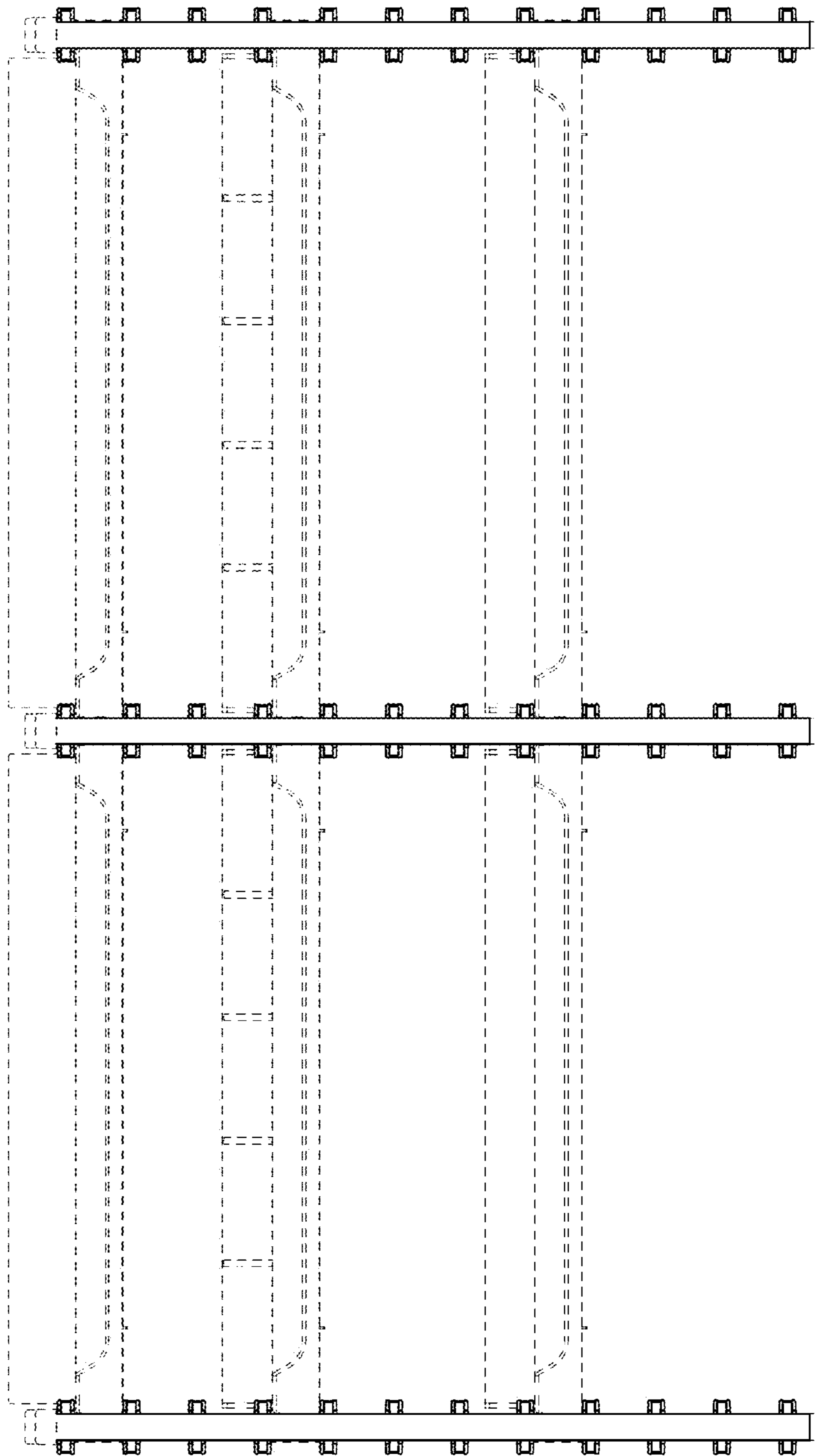

FIG. 23

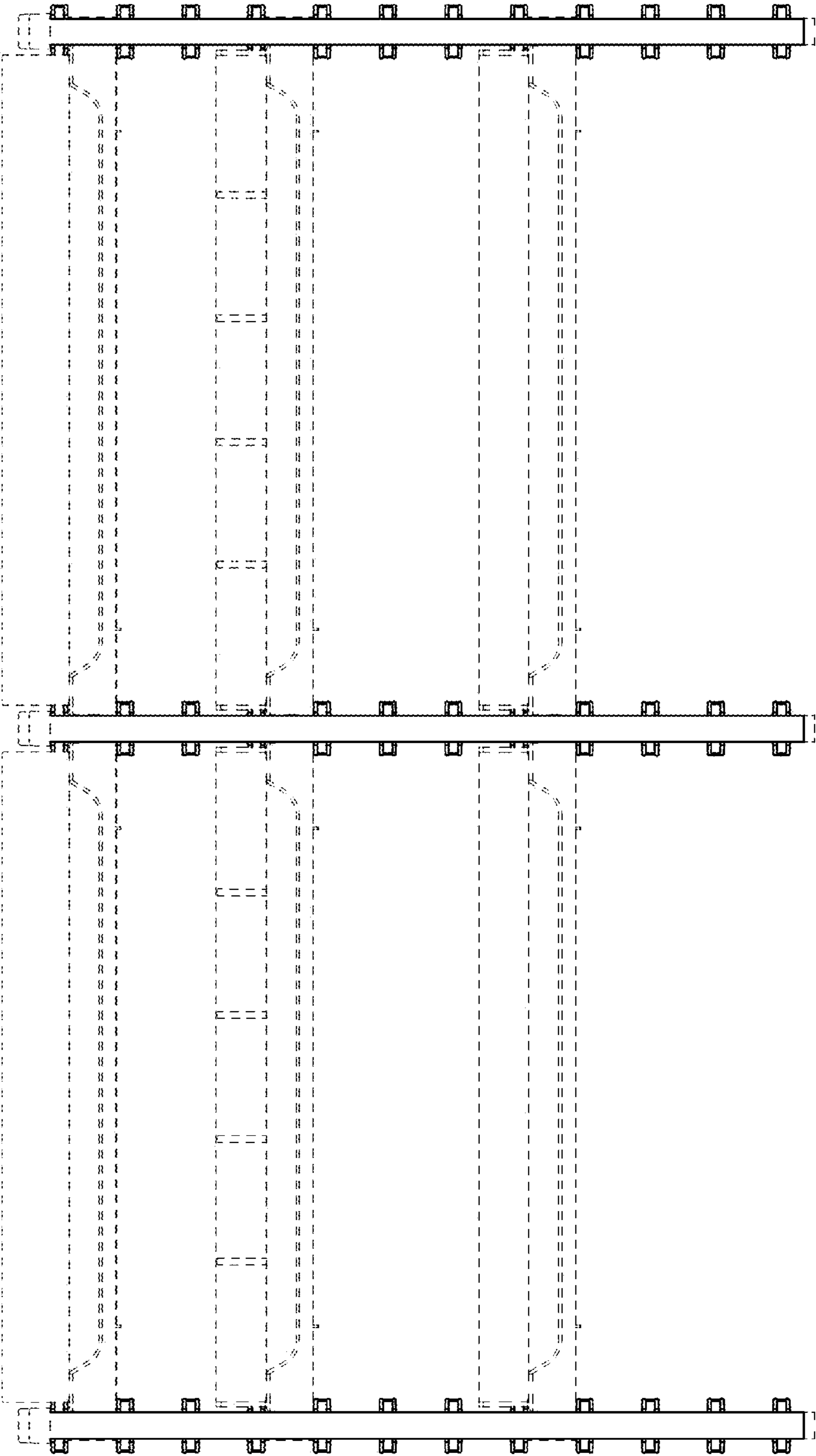

FIG. 24

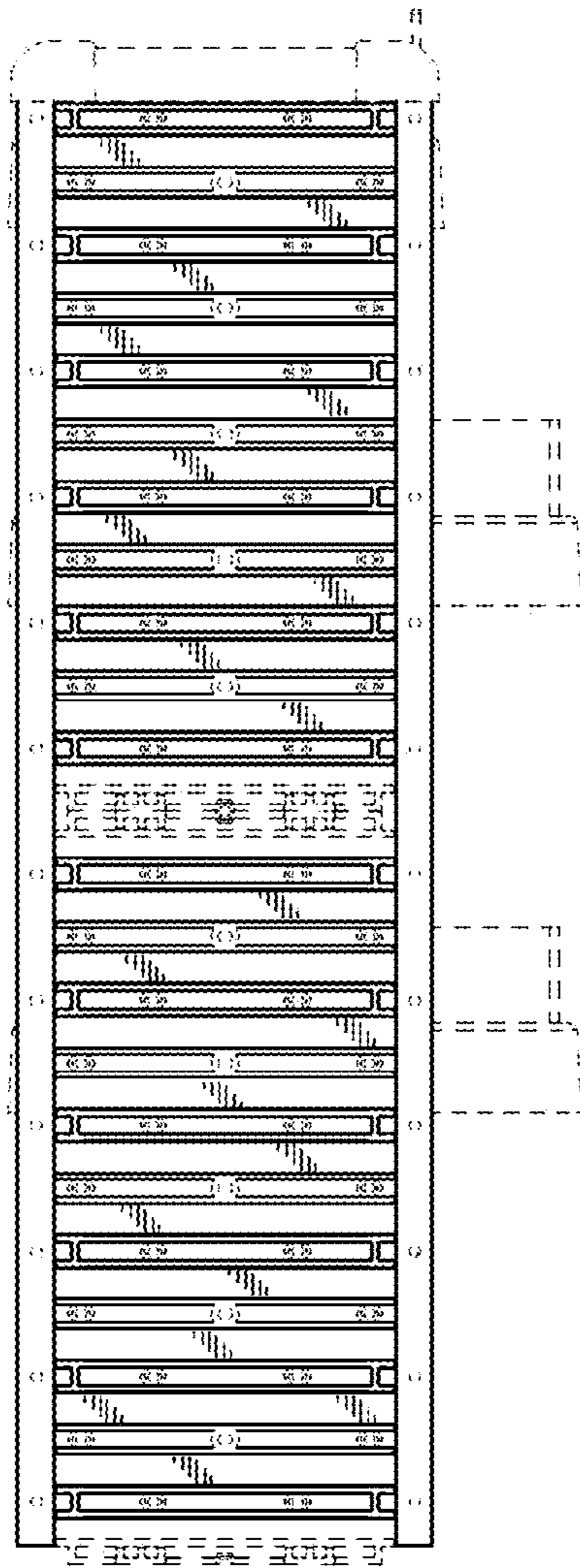

FIG. 25

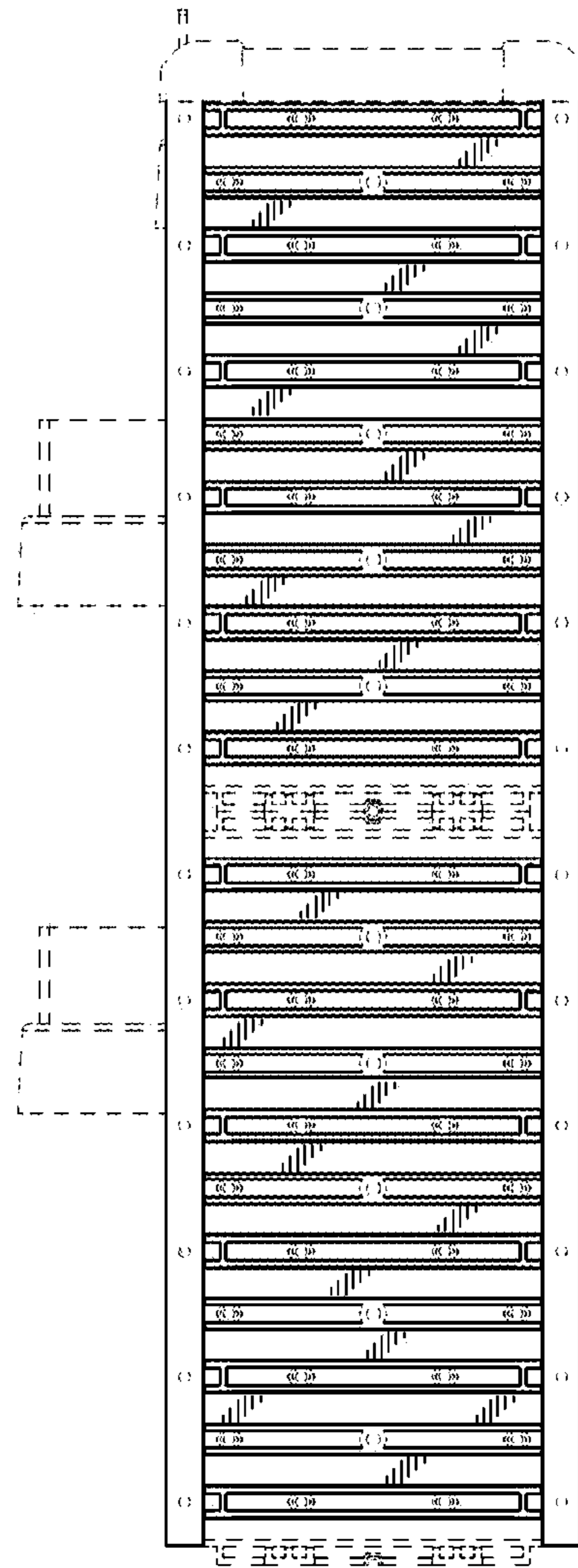

FIG. 26

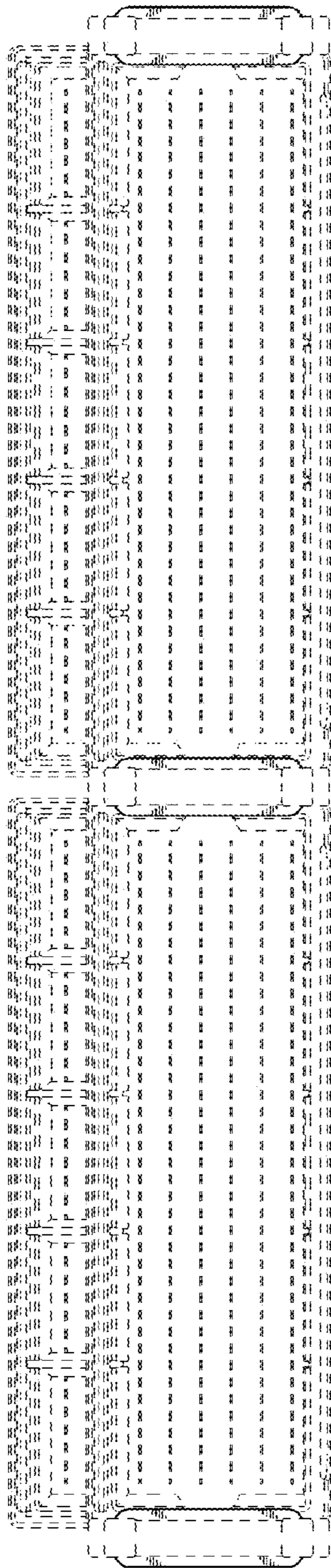

FIG. 27

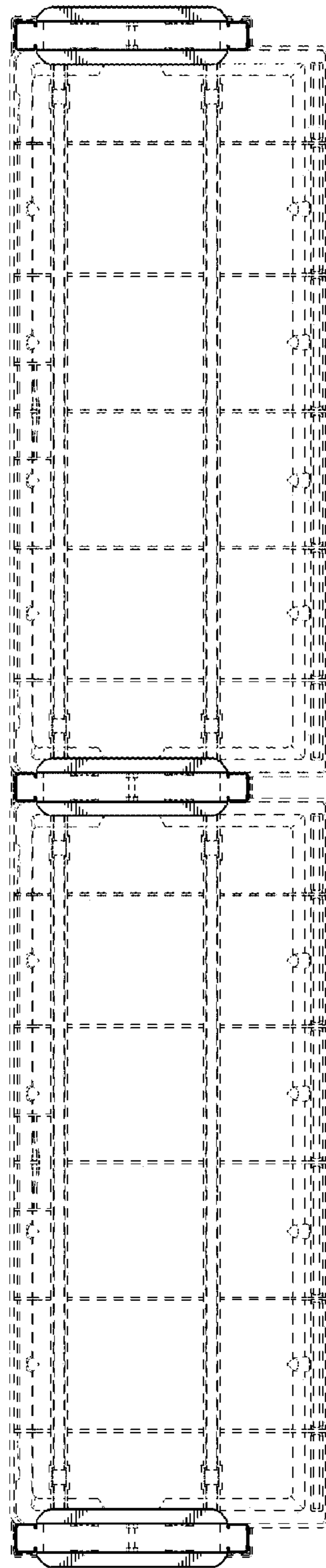

FIG. 28

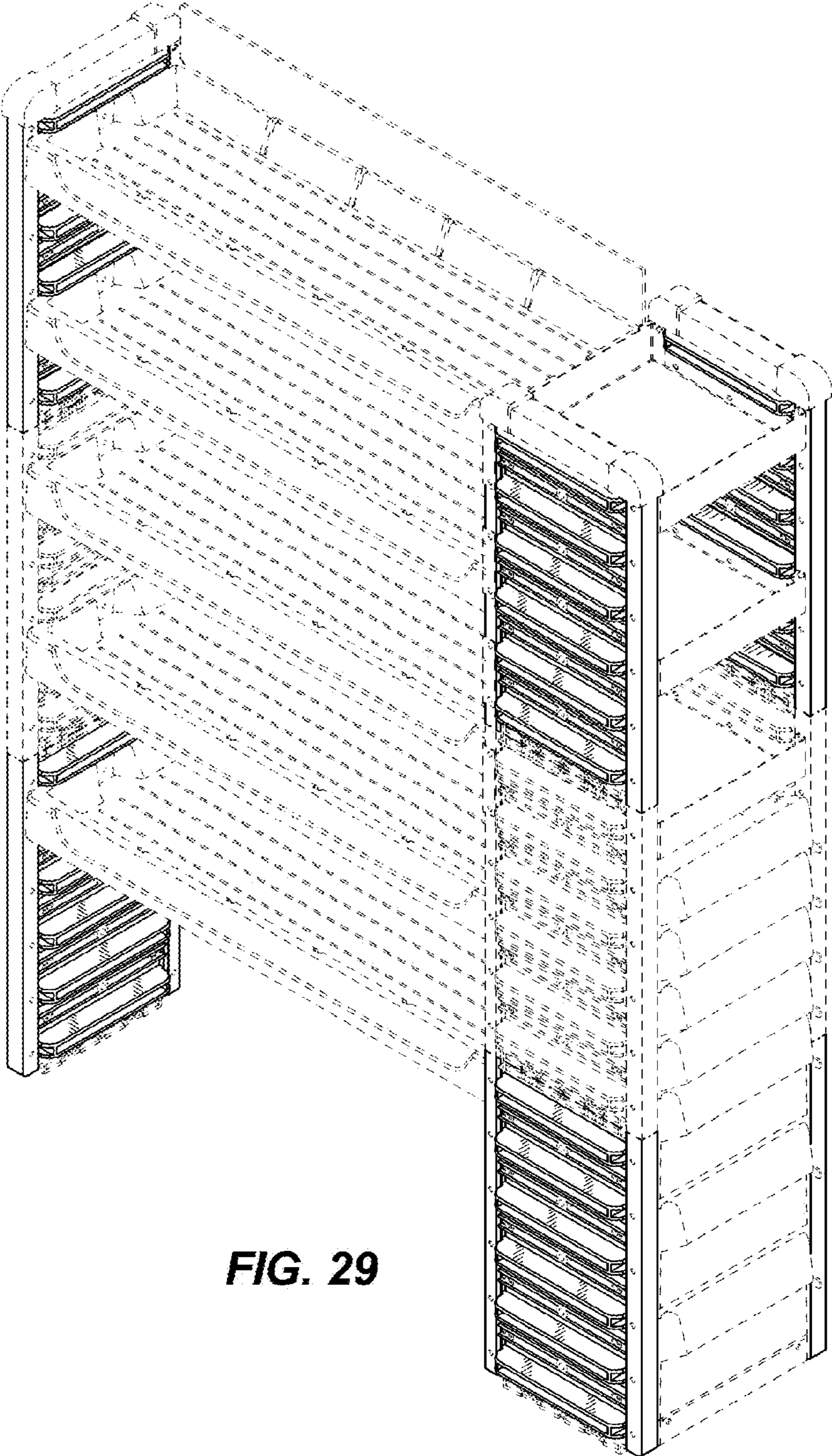

FIG. 29

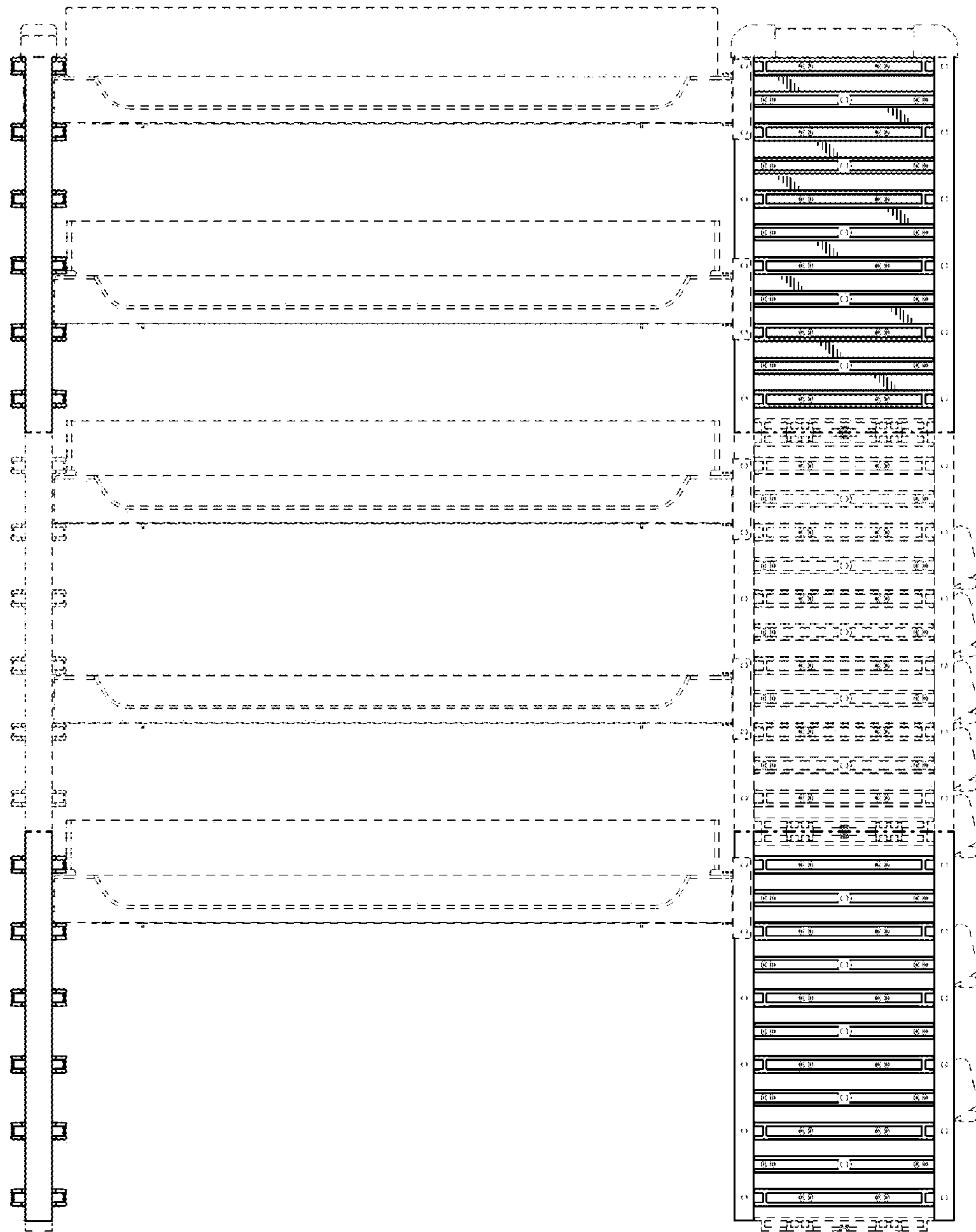

FIG. 30

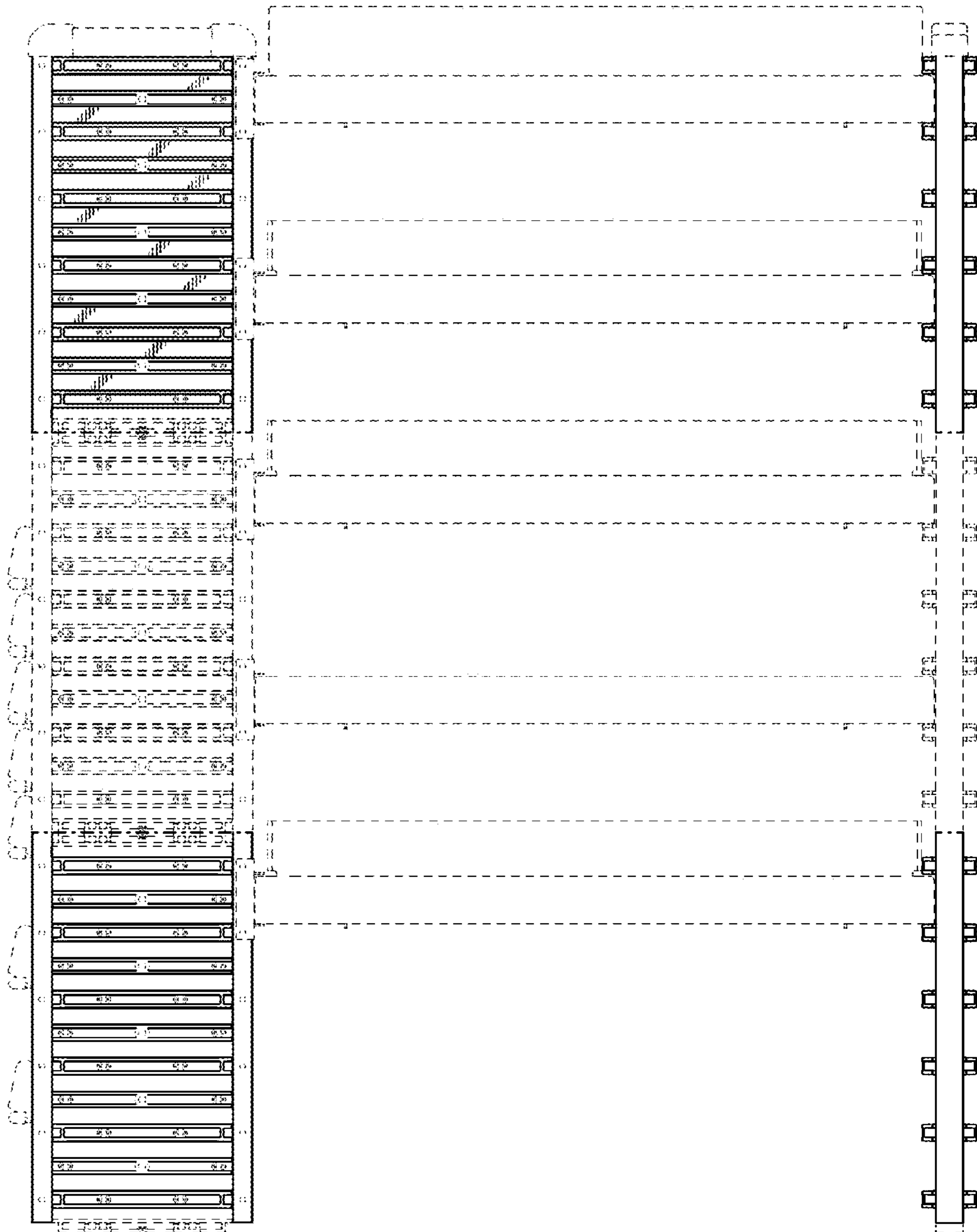

FIG. 31

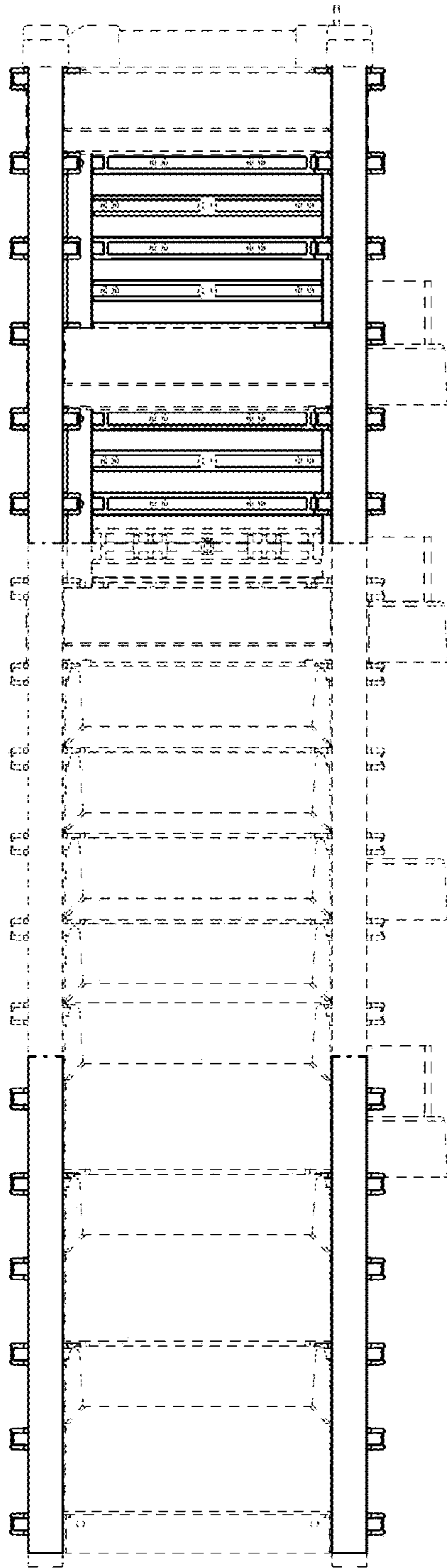

FIG. 32

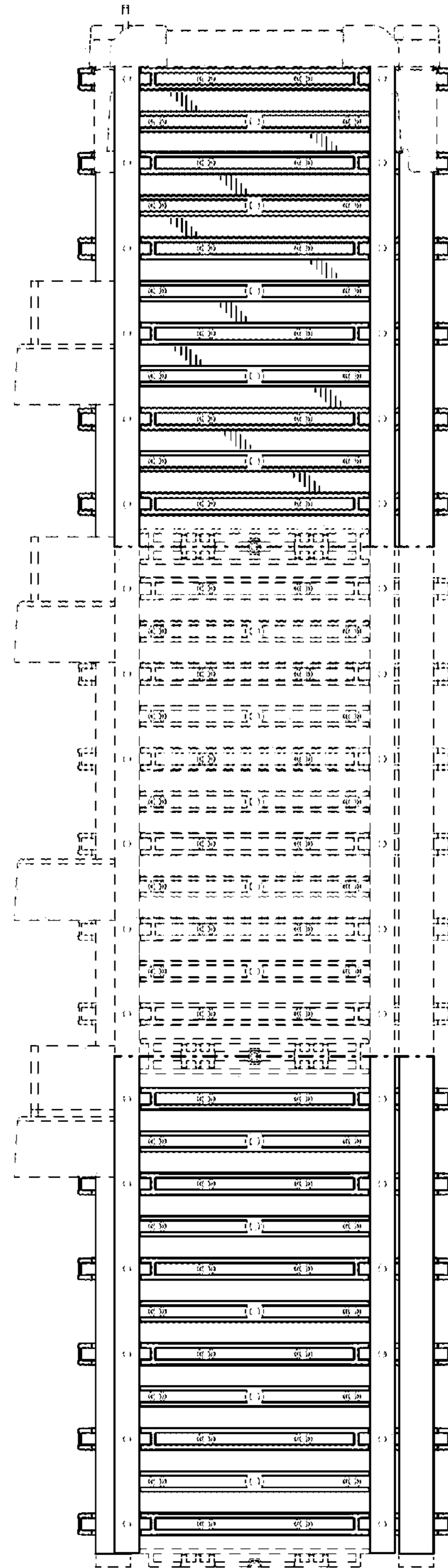

FIG. 33

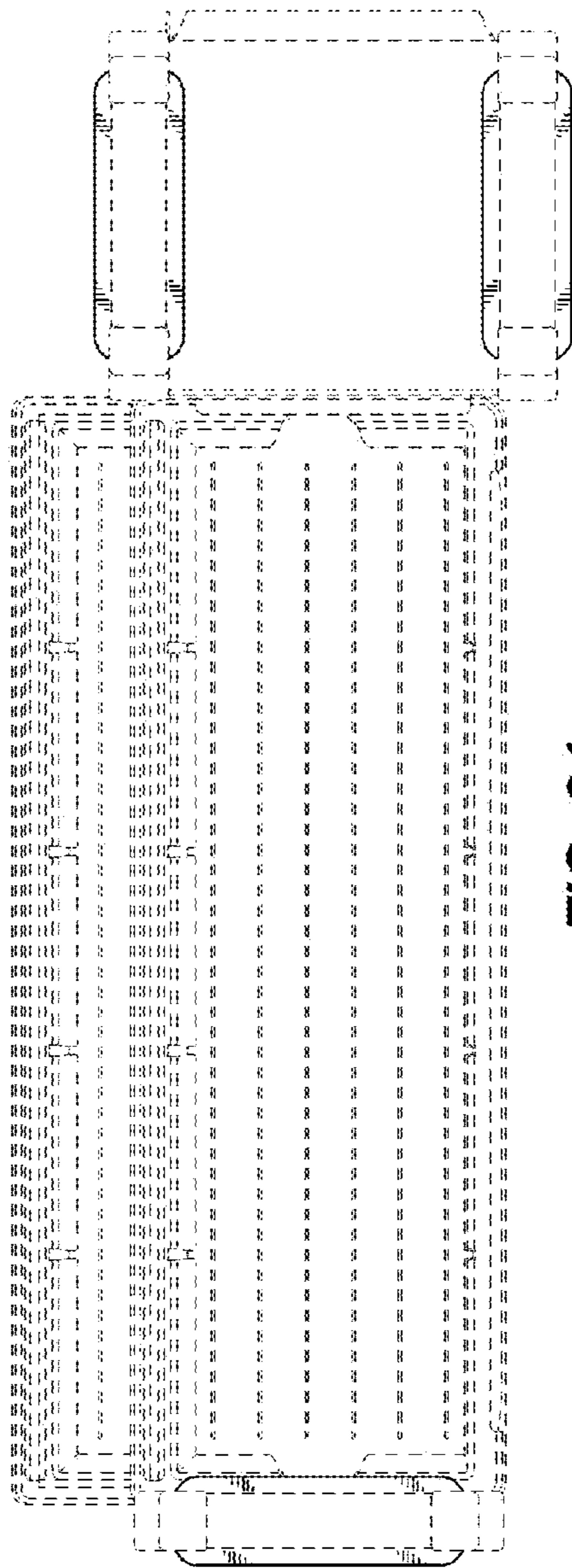

FIG. 34

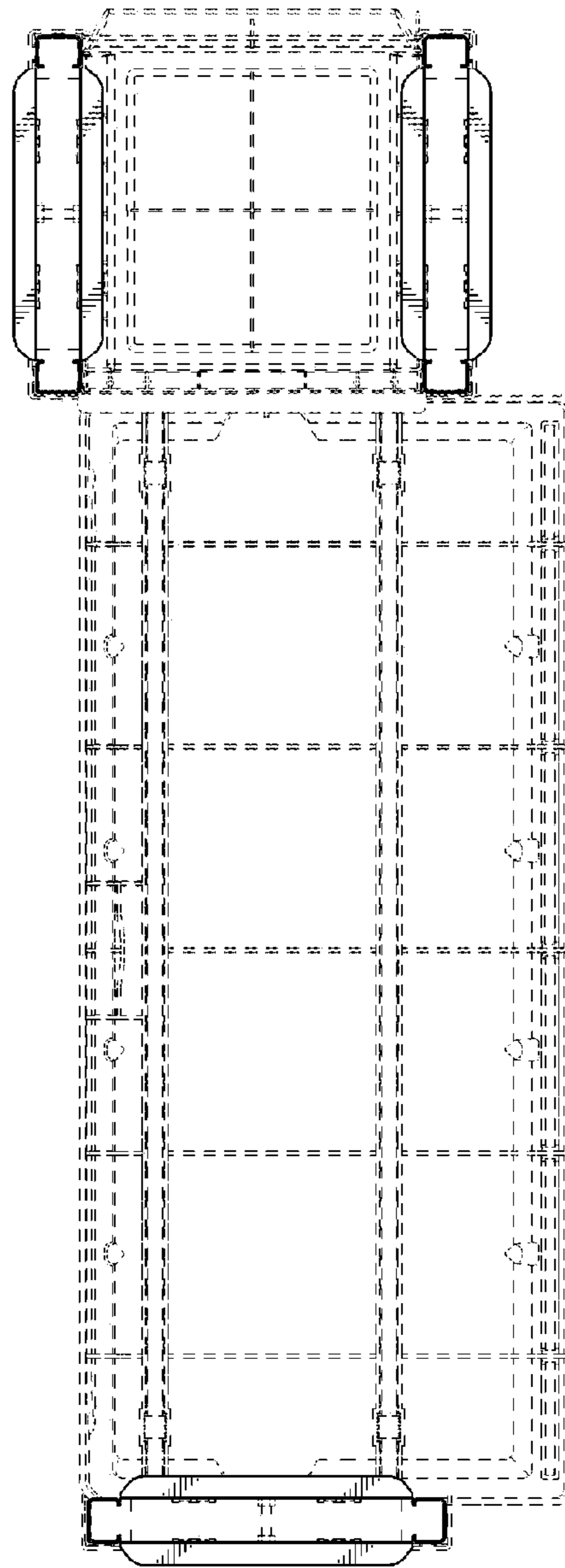

FIG. 35

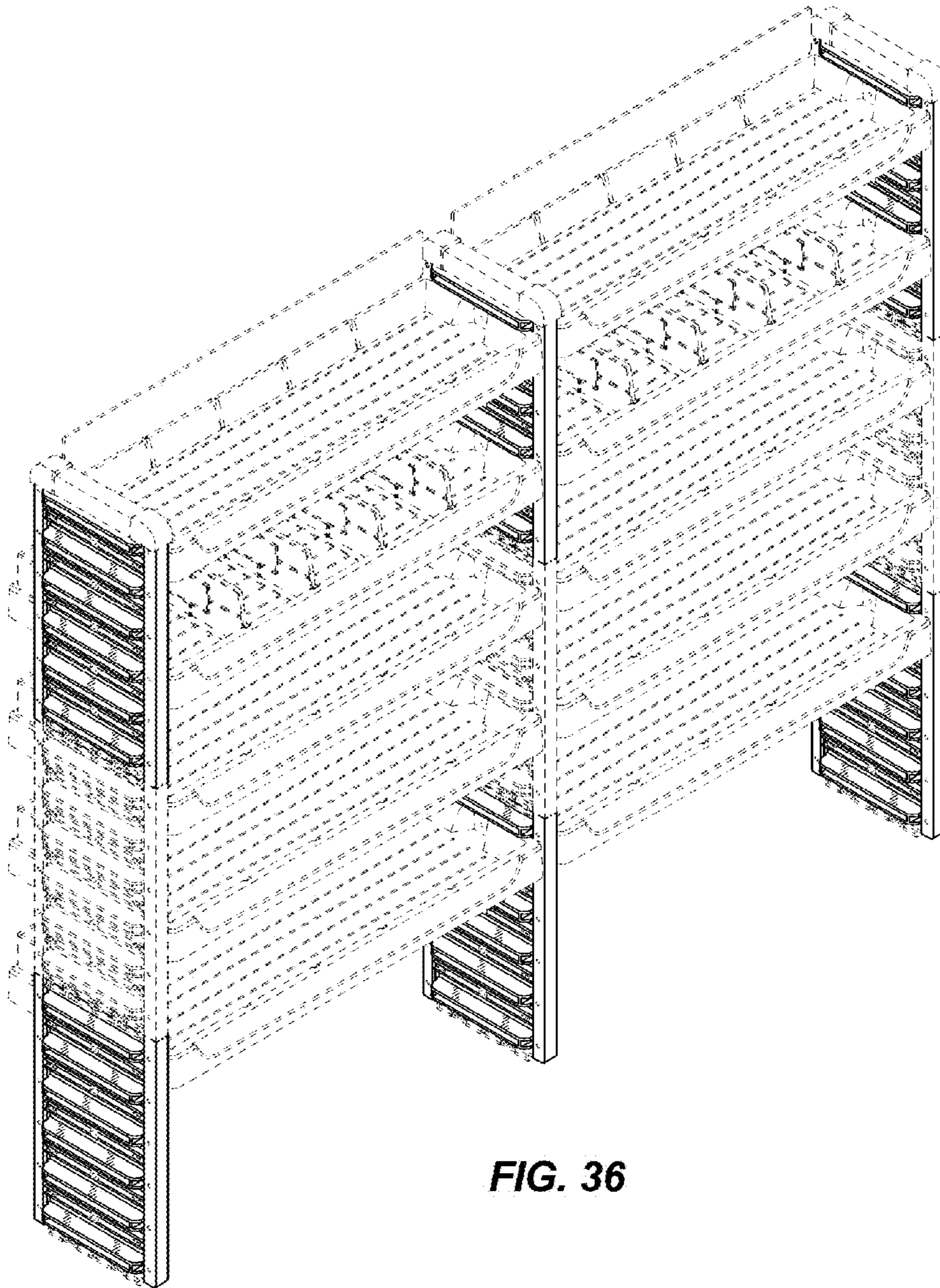

FIG. 36

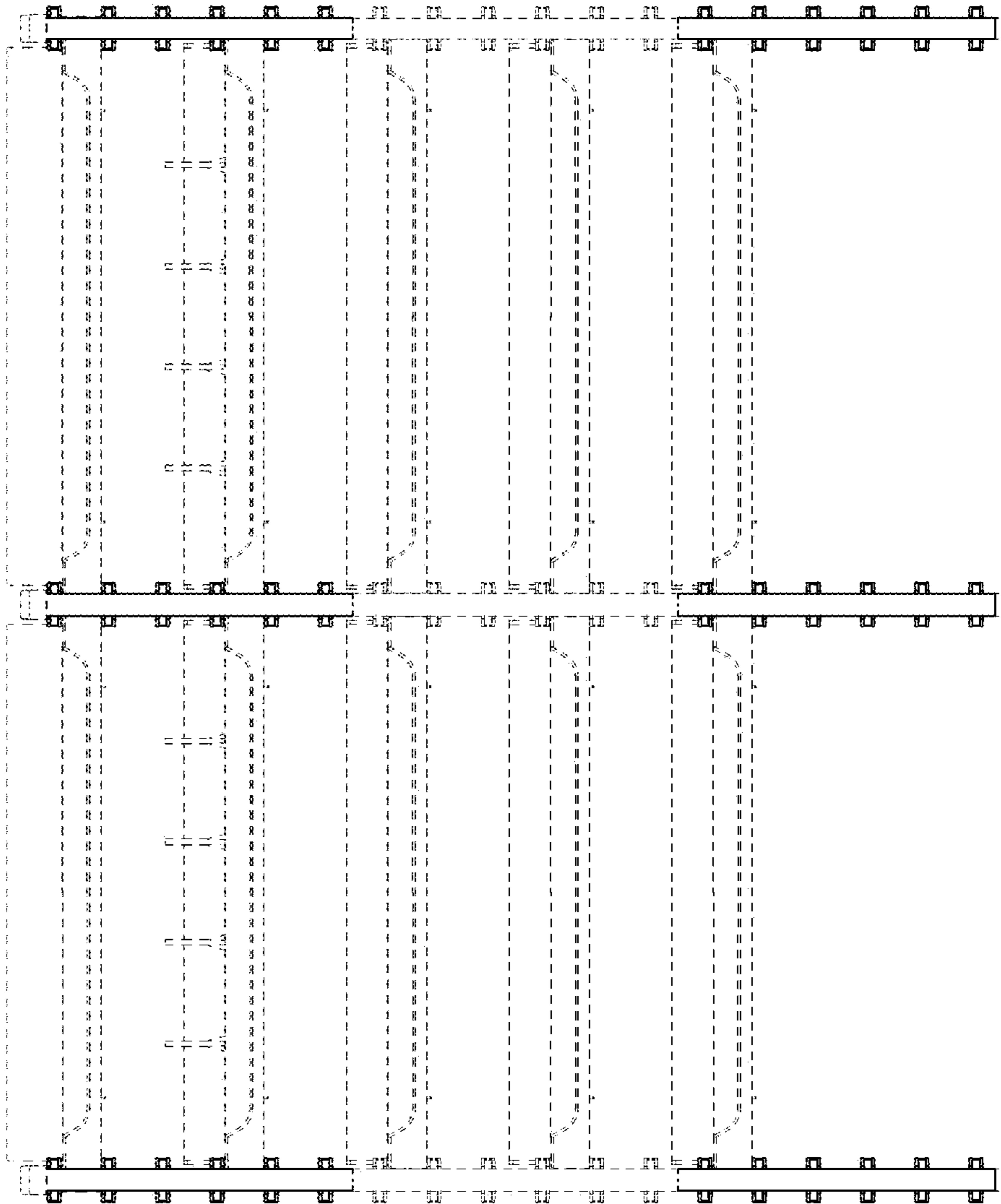

FIG. 37

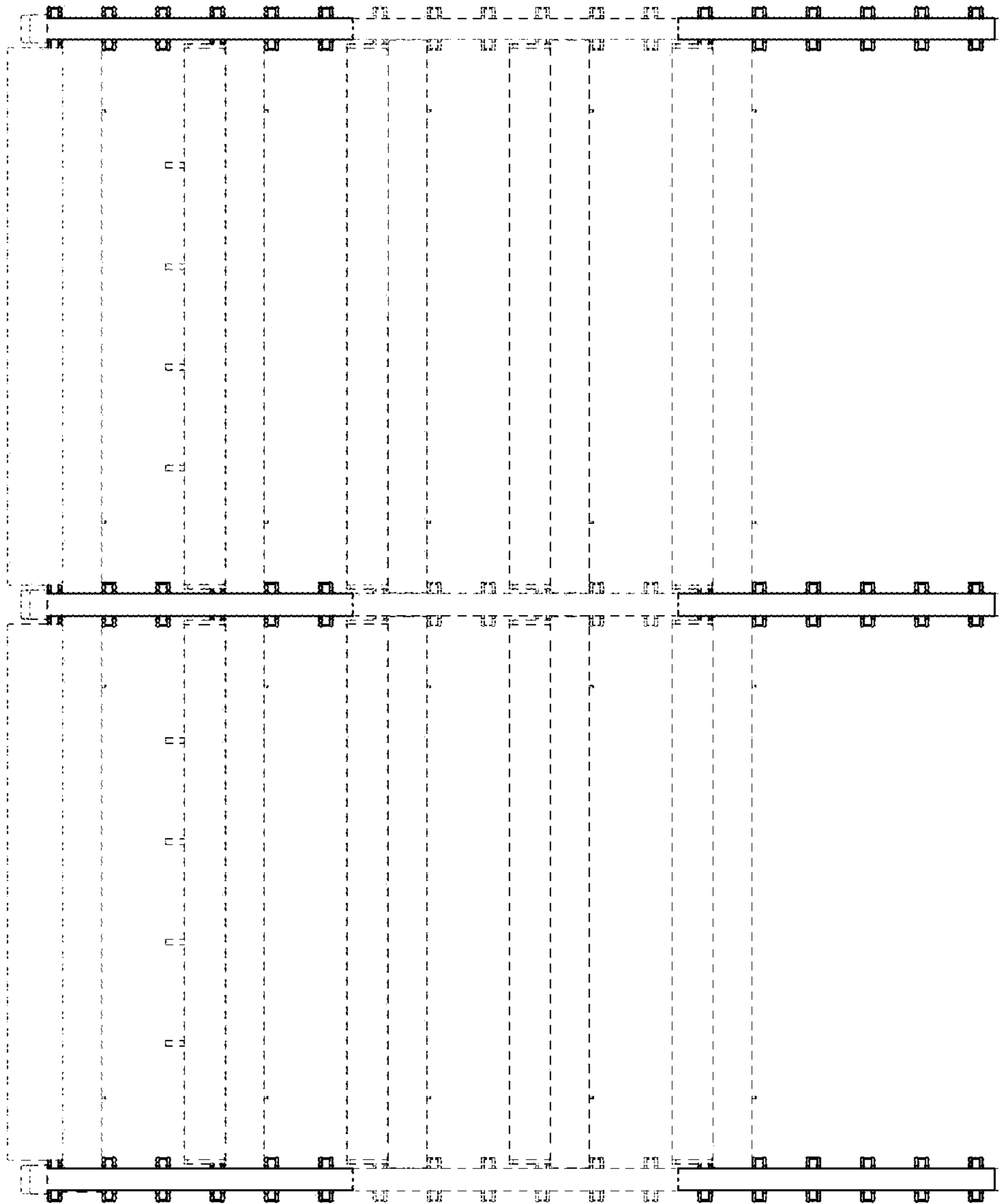

FIG. 38

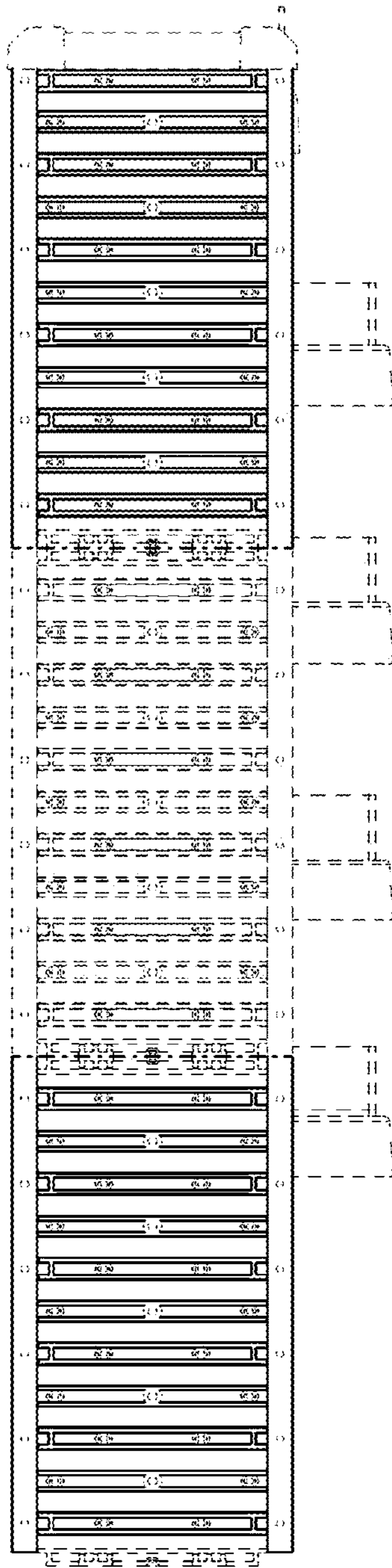

FIG. 39

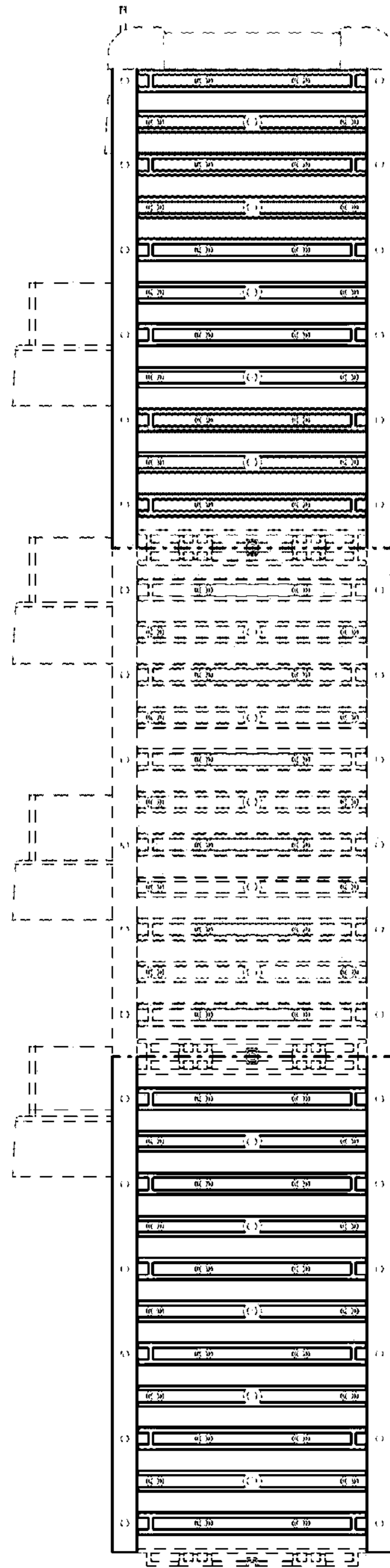

FIG. 40

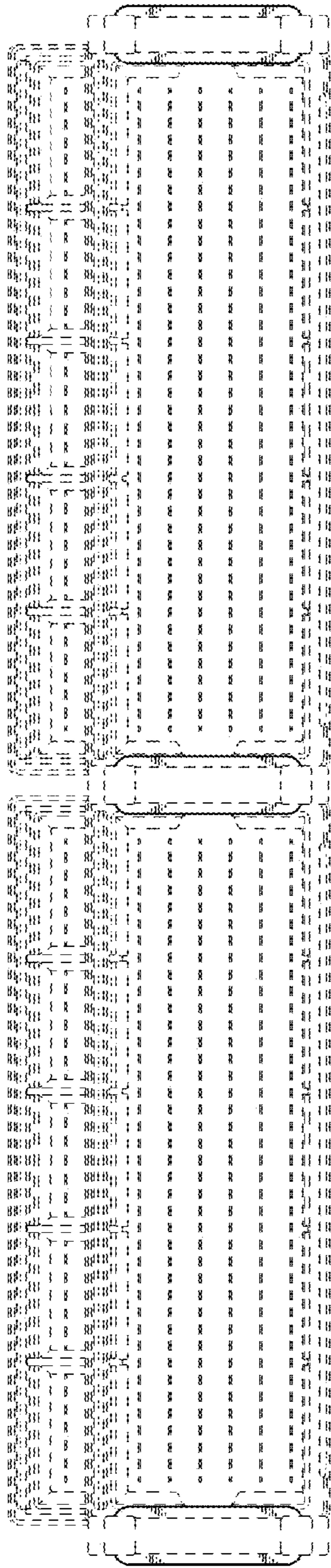

FIG. 41

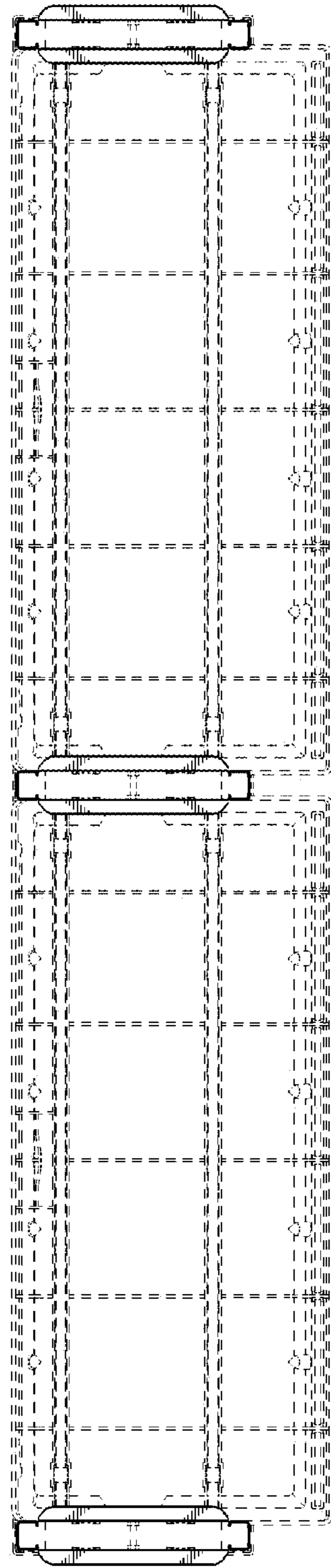

FIG. 42

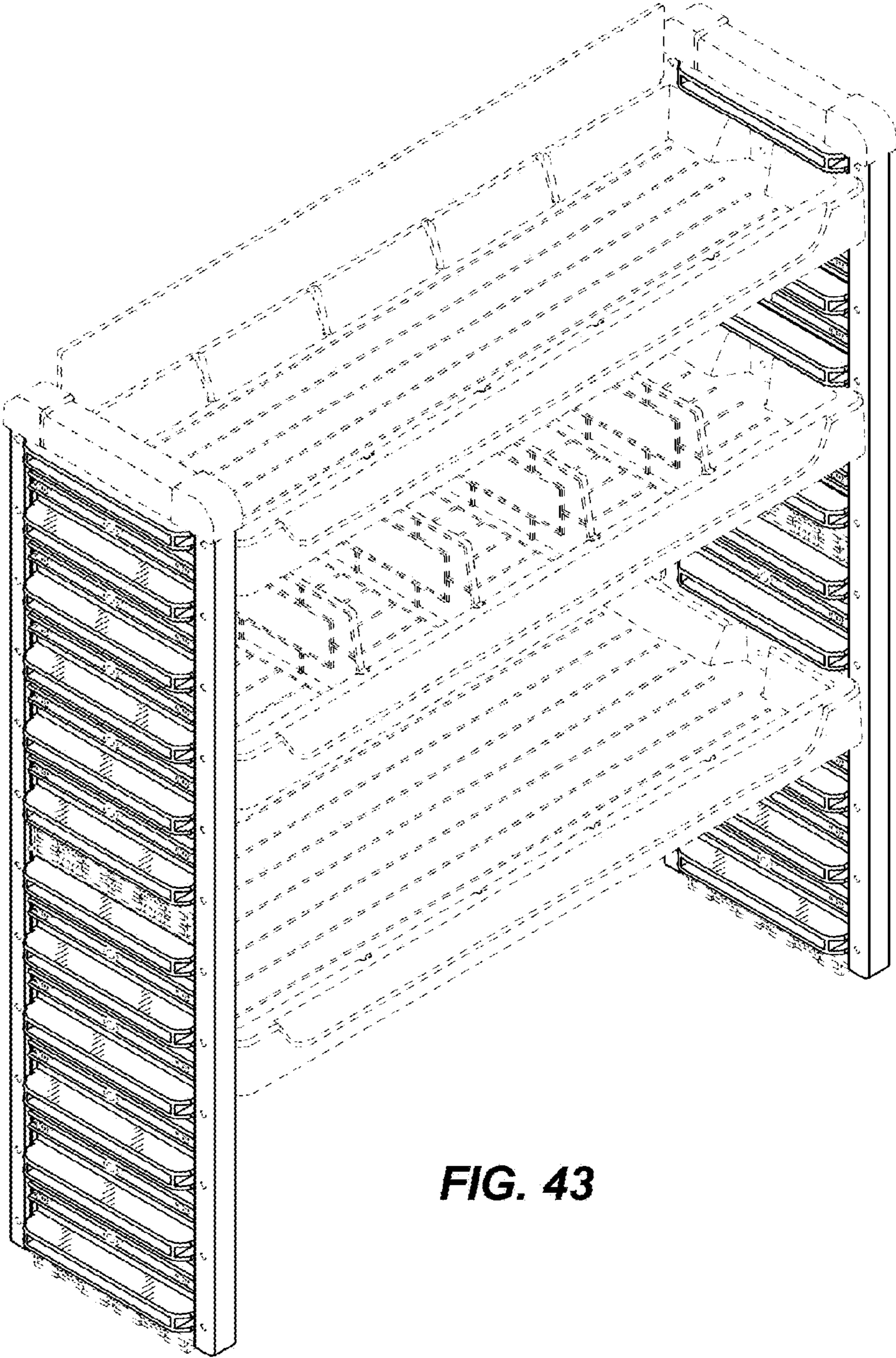

FIG. 43

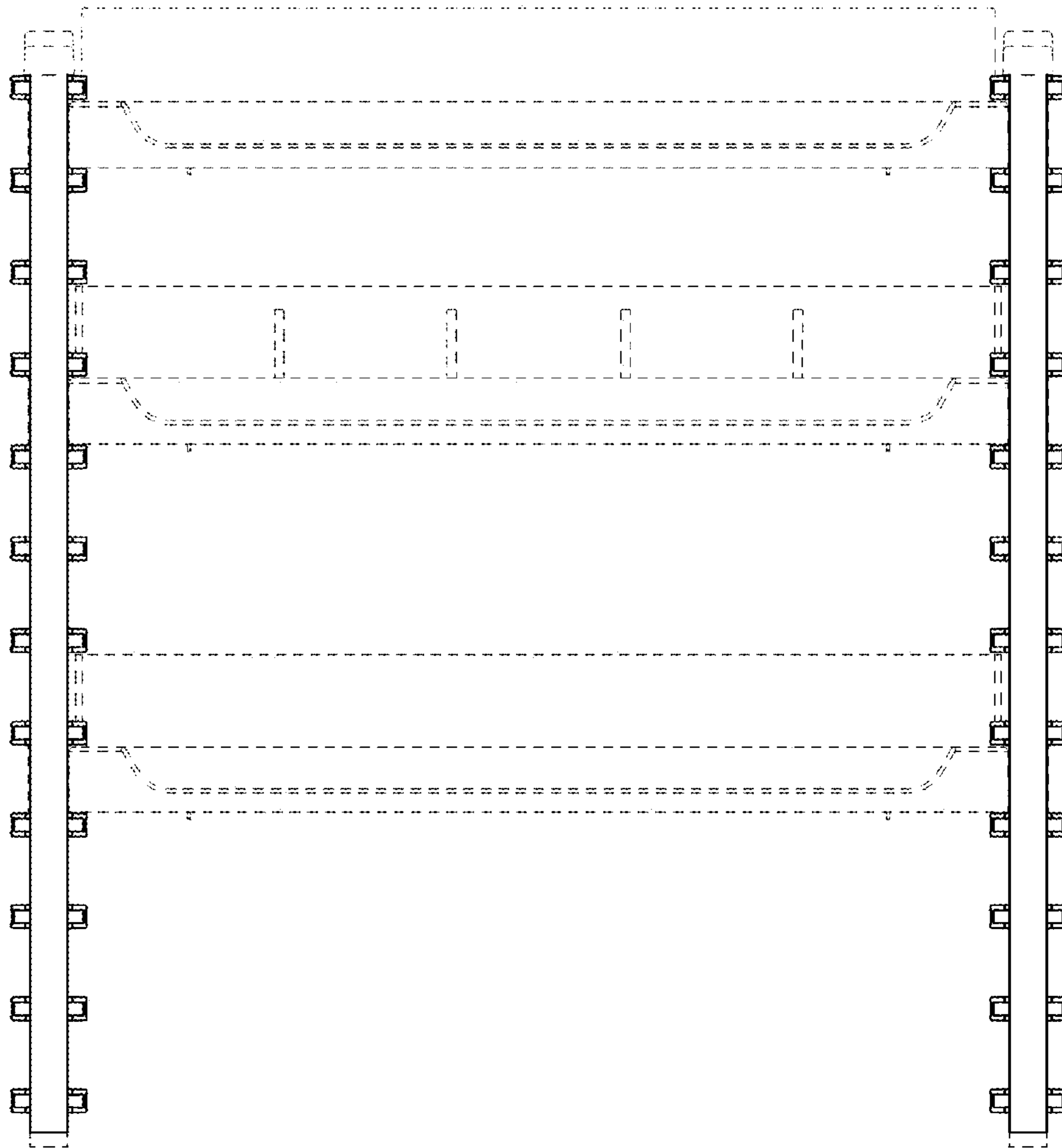

FIG. 44

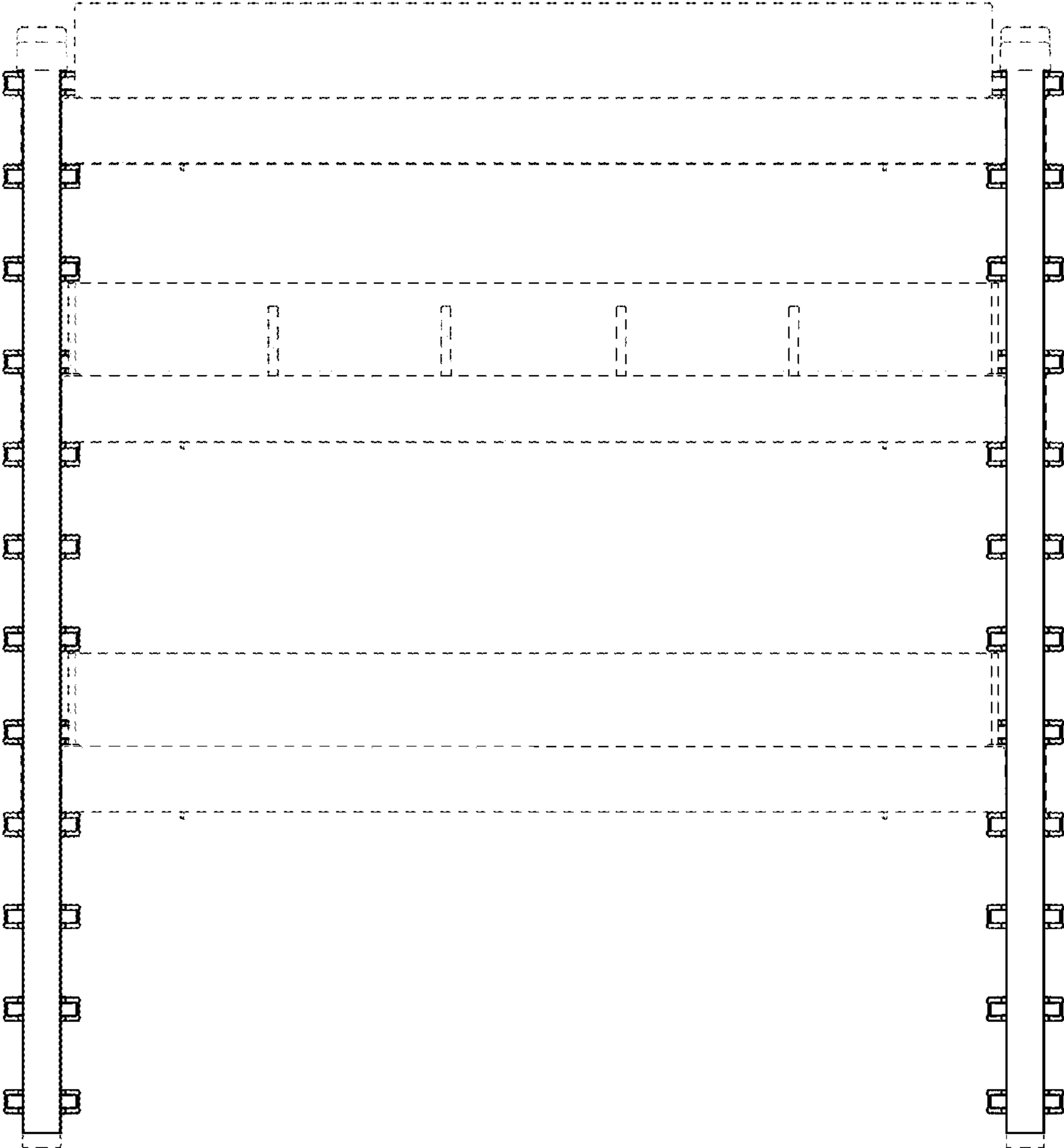

FIG. 45

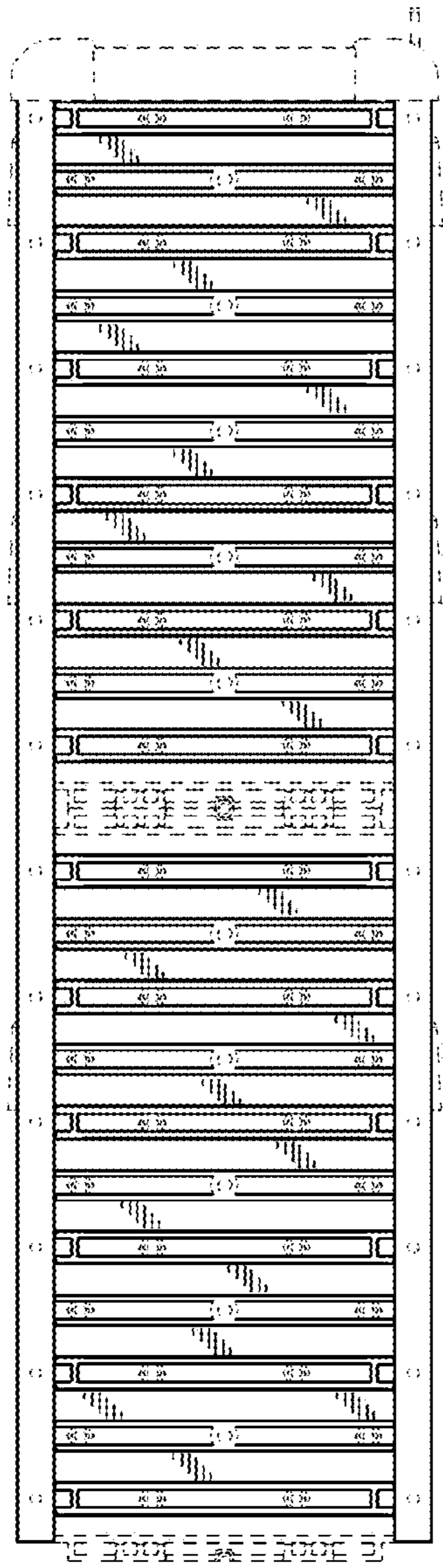

FIG. 46

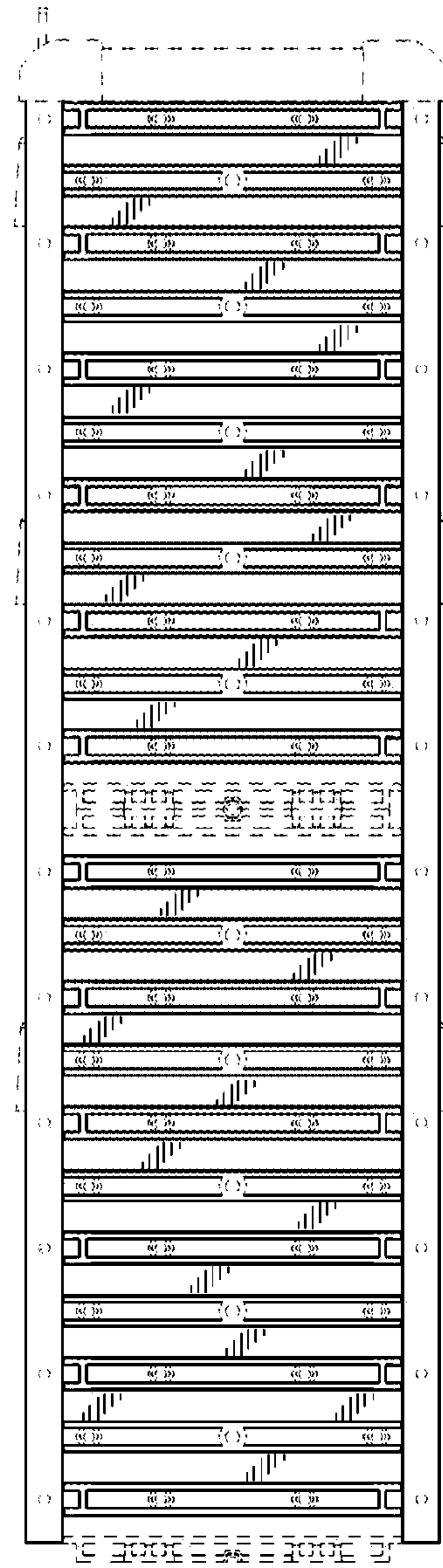

FIG. 47

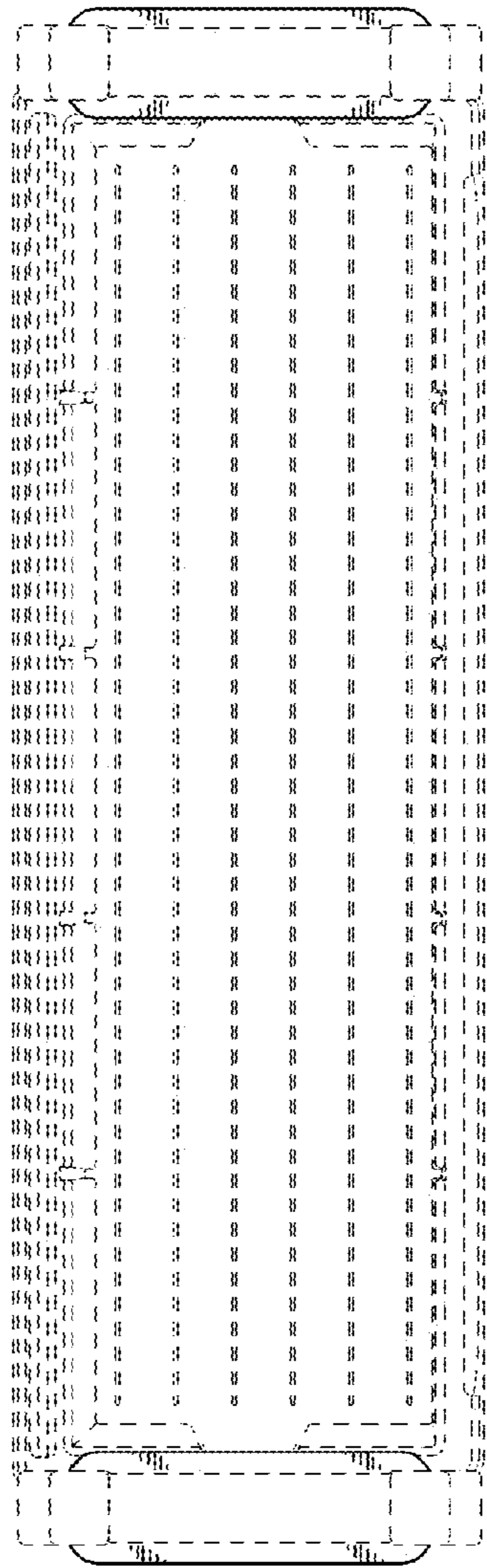

FIG. 48

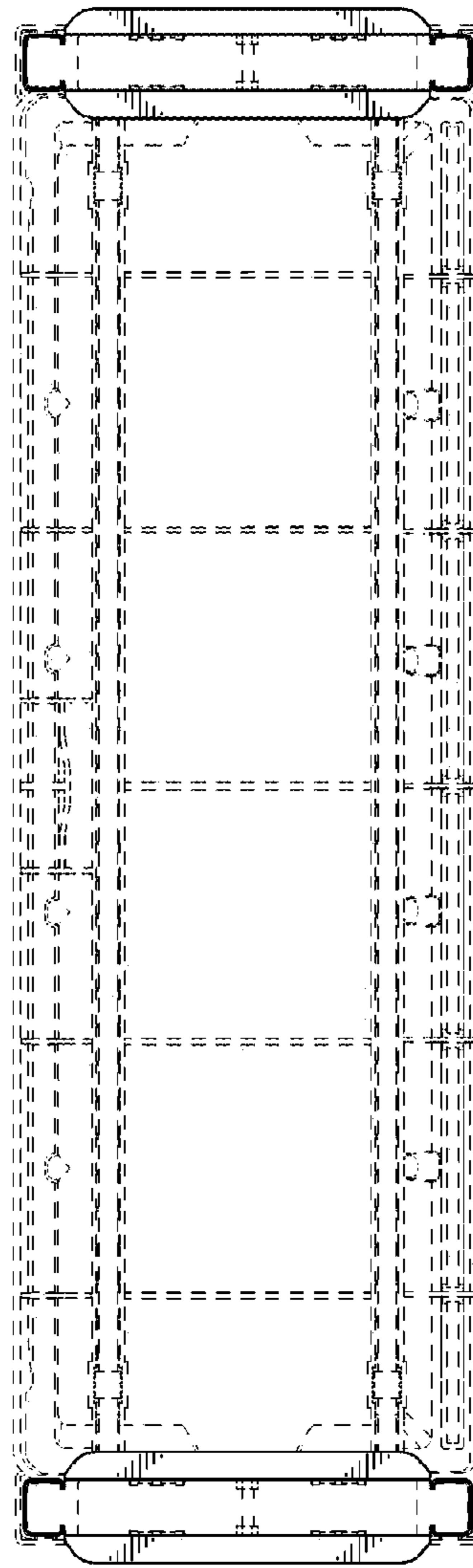

FIG. 49

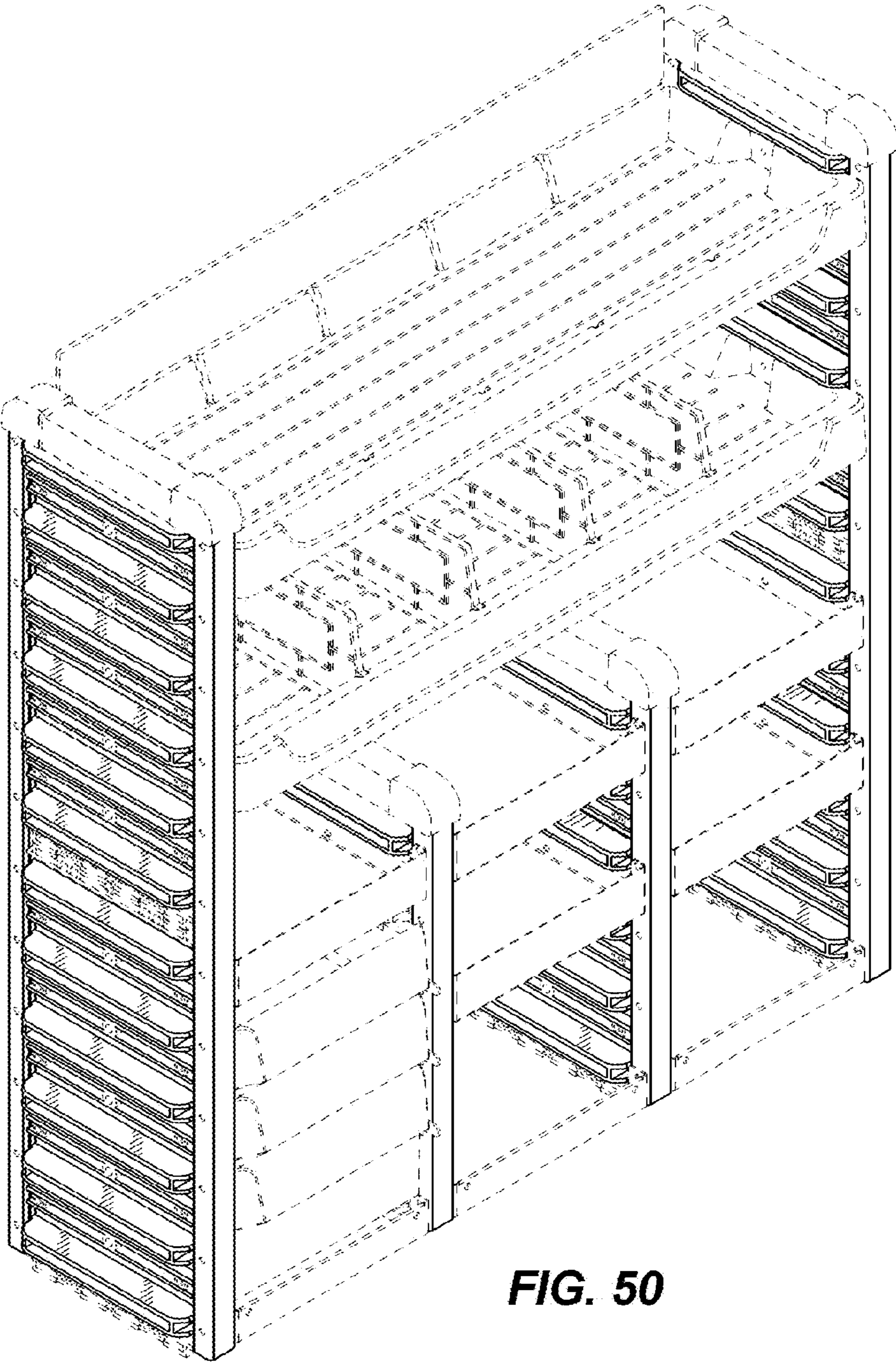

FIG. 50

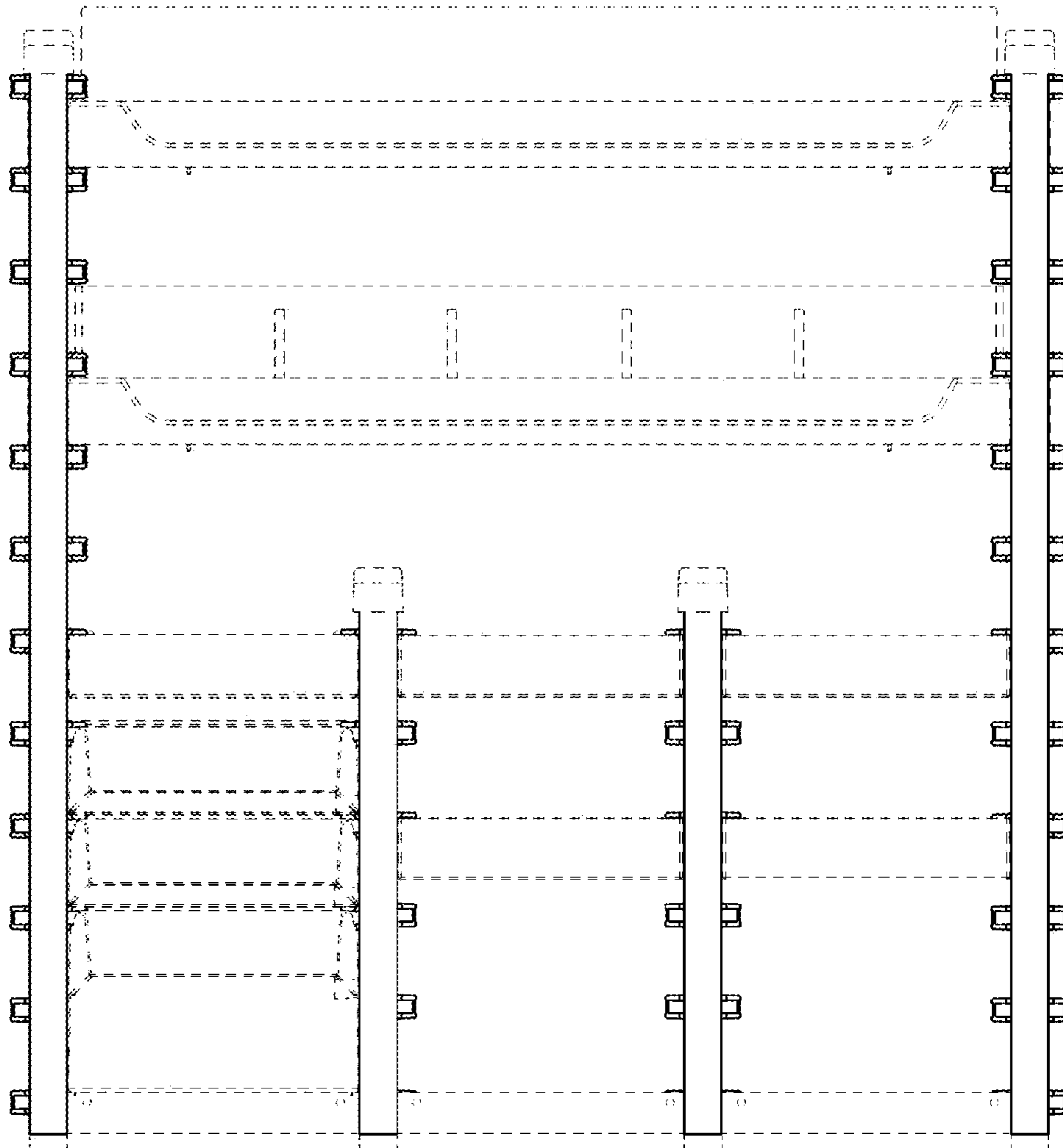

FIG. 51

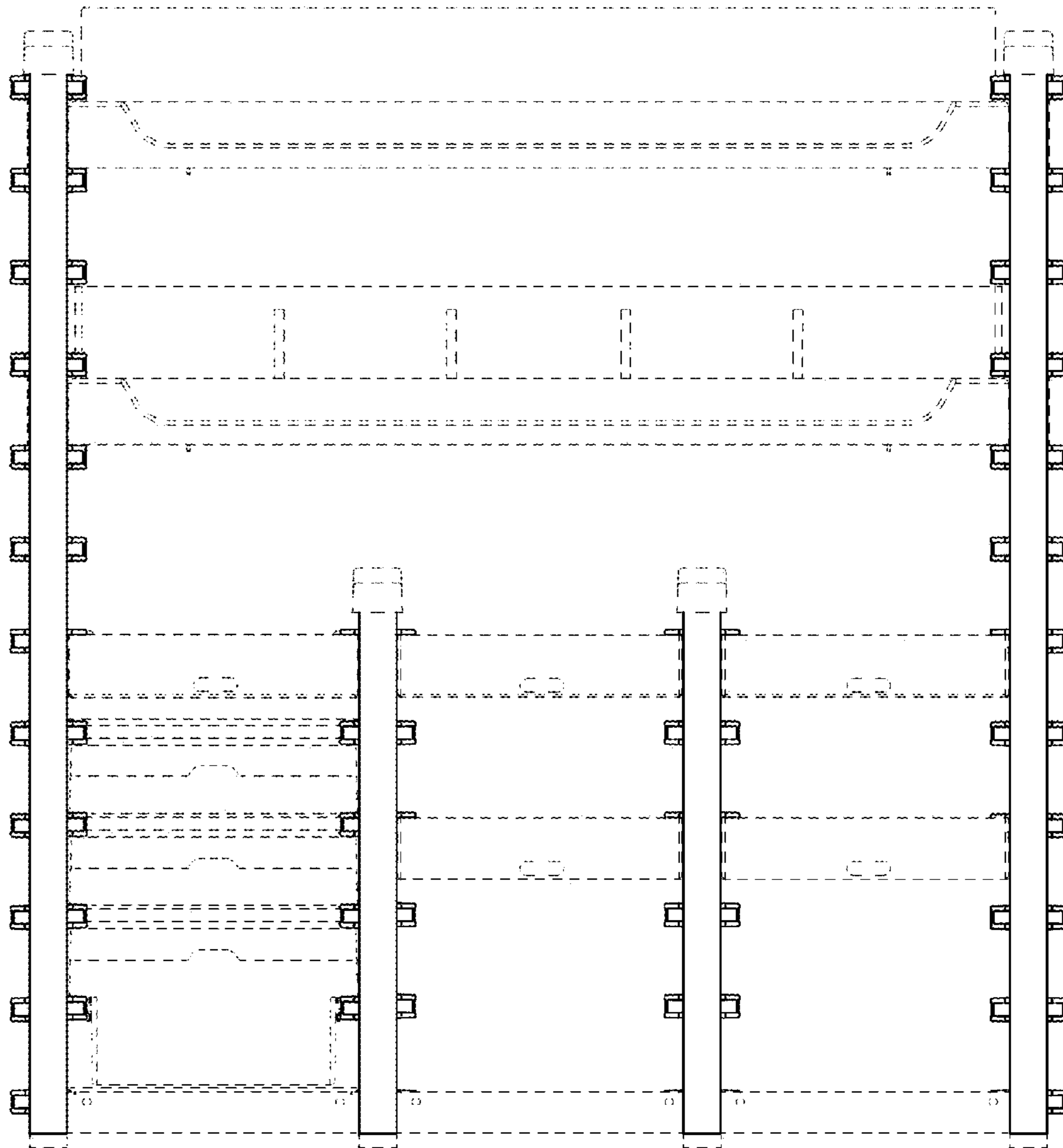

FIG. 52

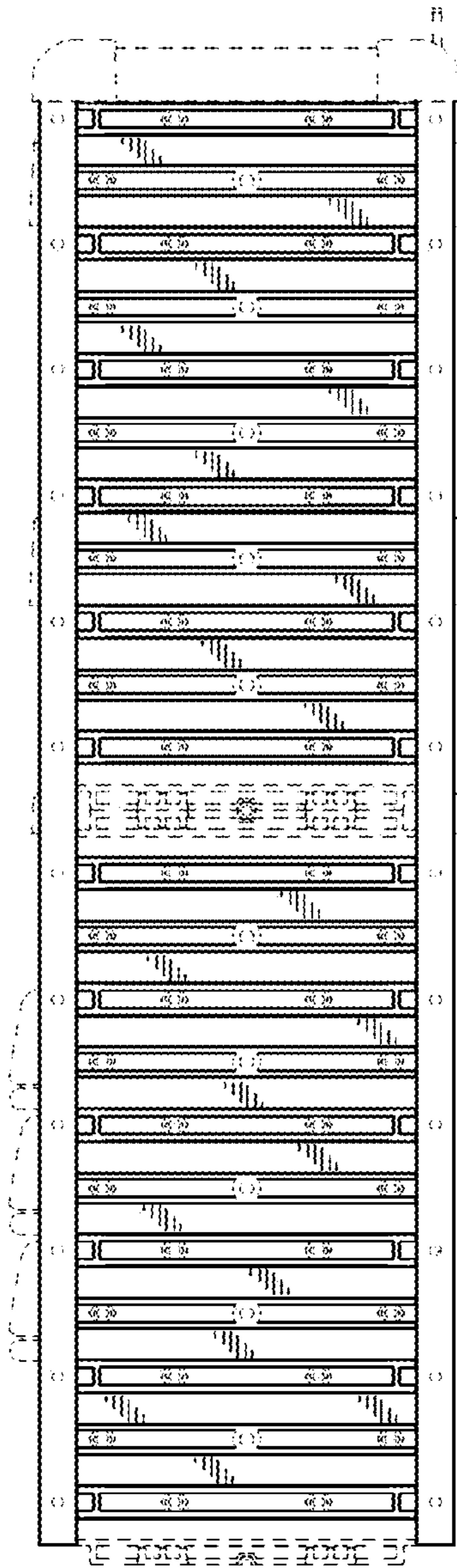

FIG. 53

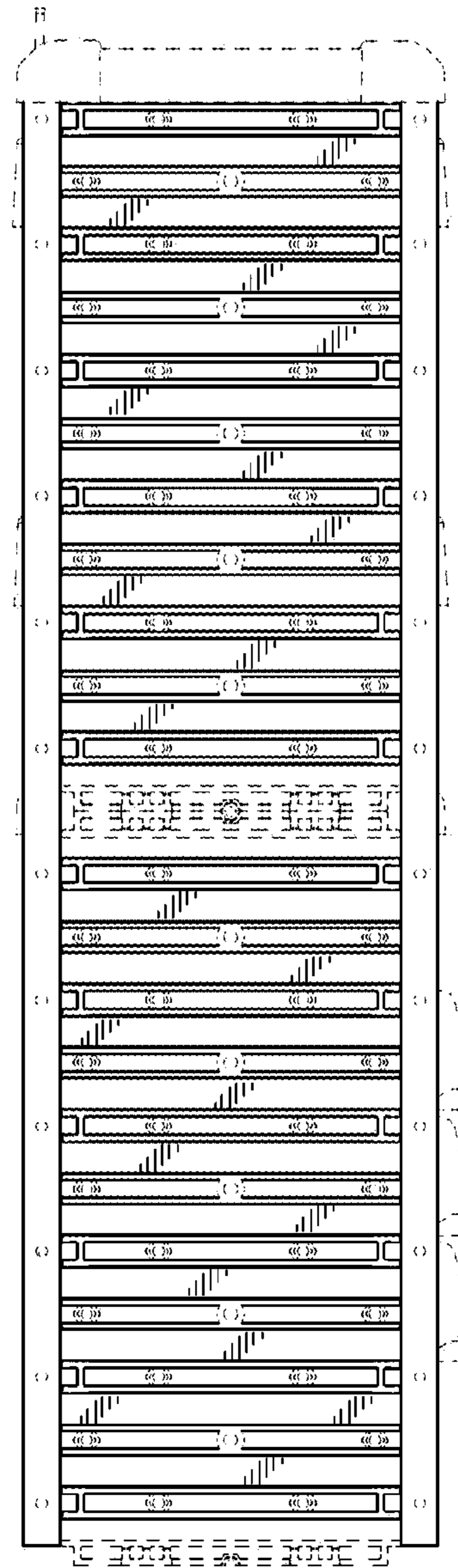

FIG. 54

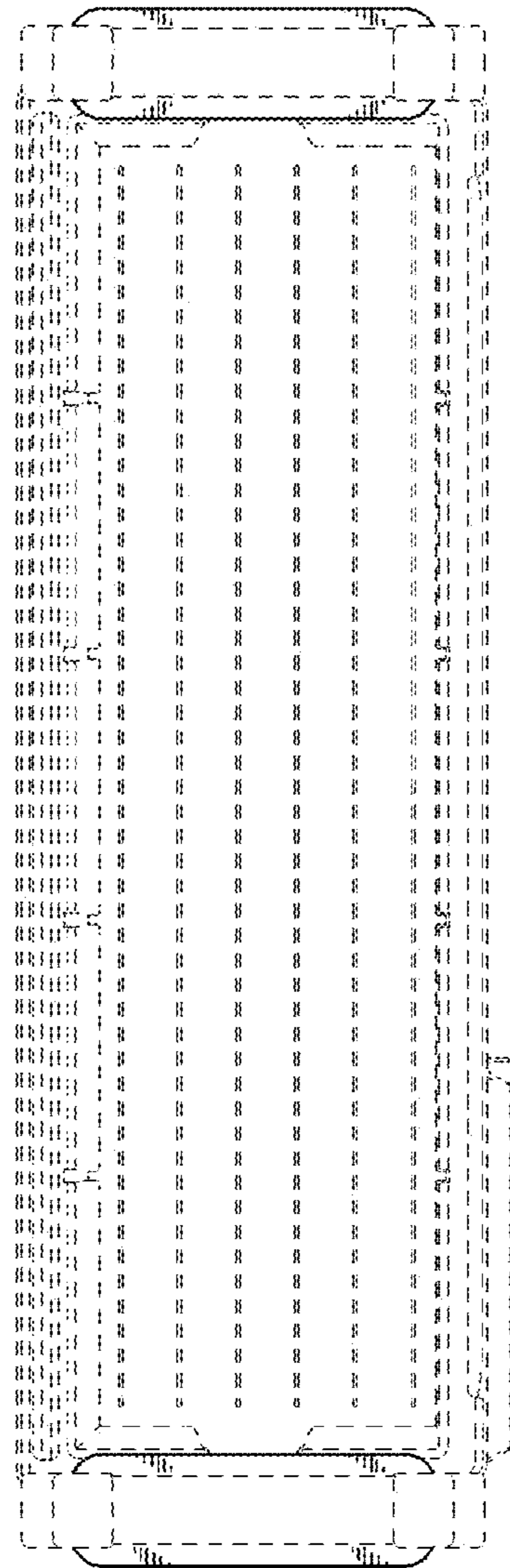

FIG. 55

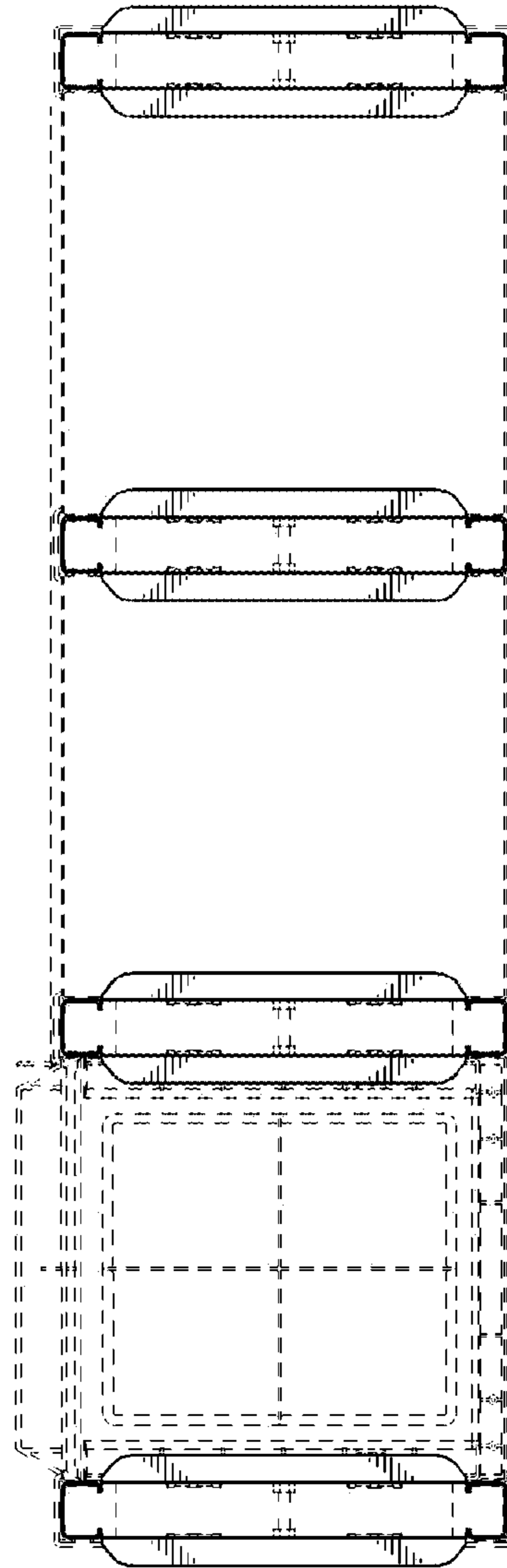

FIG. 56

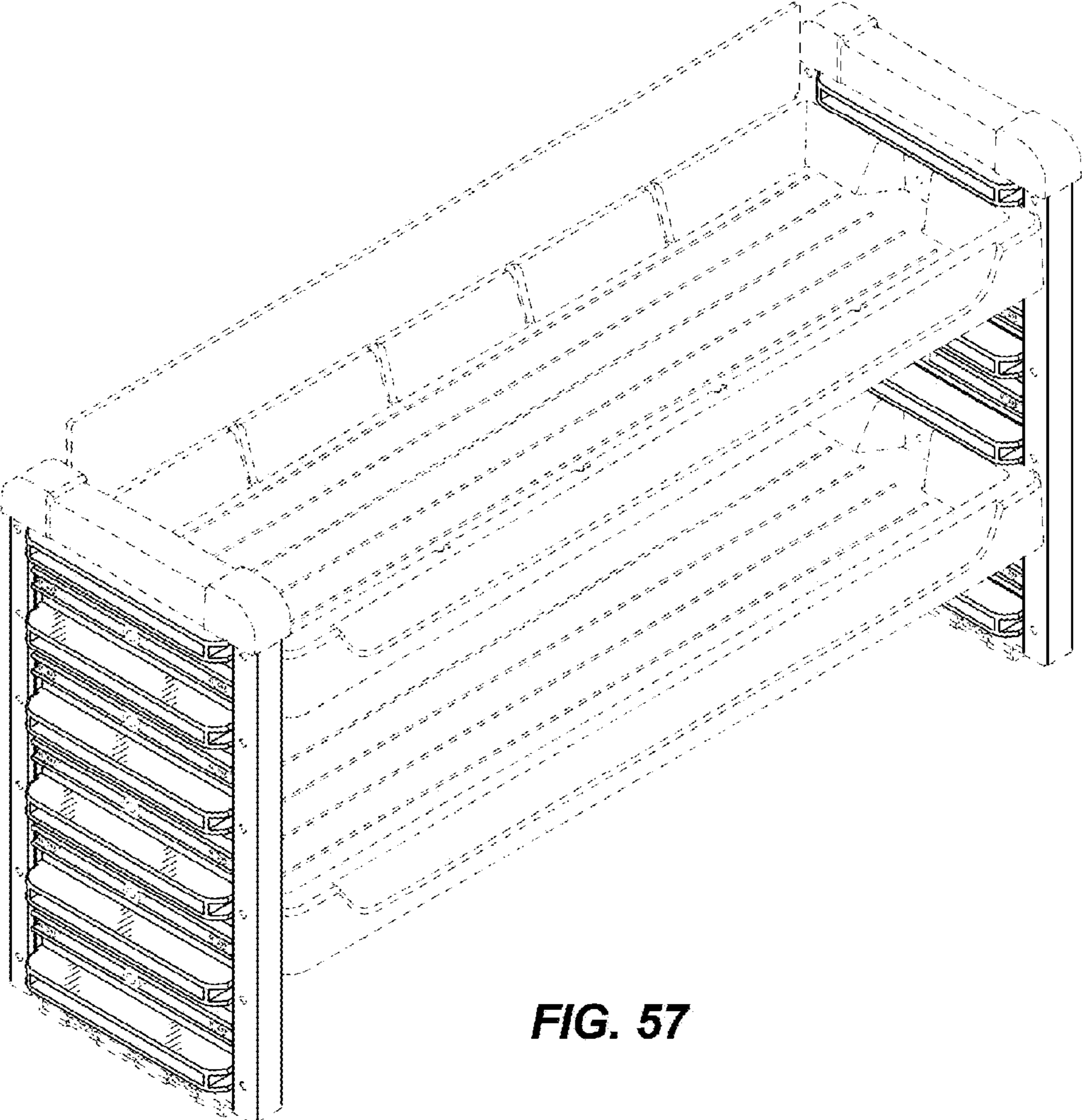

FIG. 57

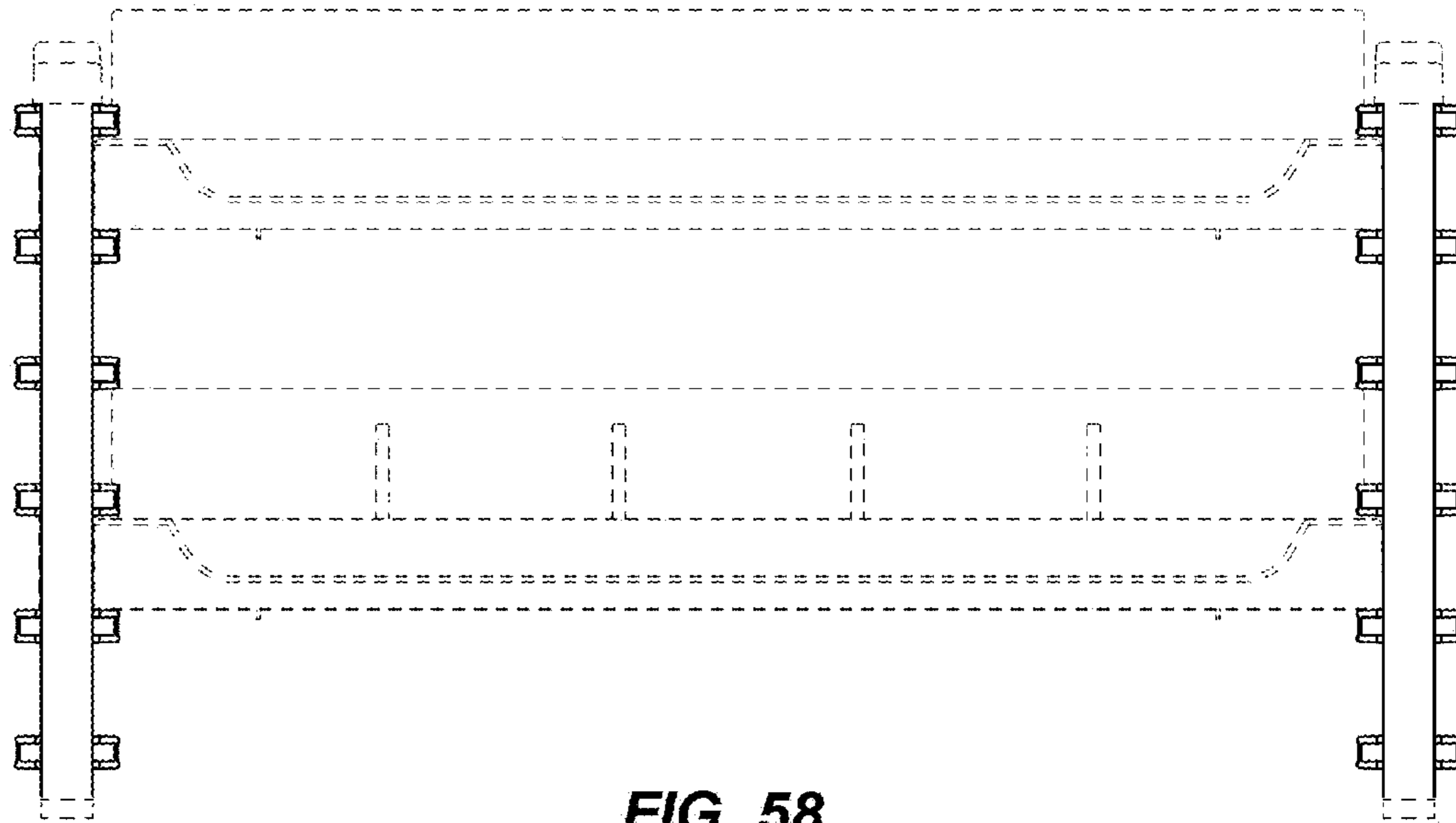

FIG. 58

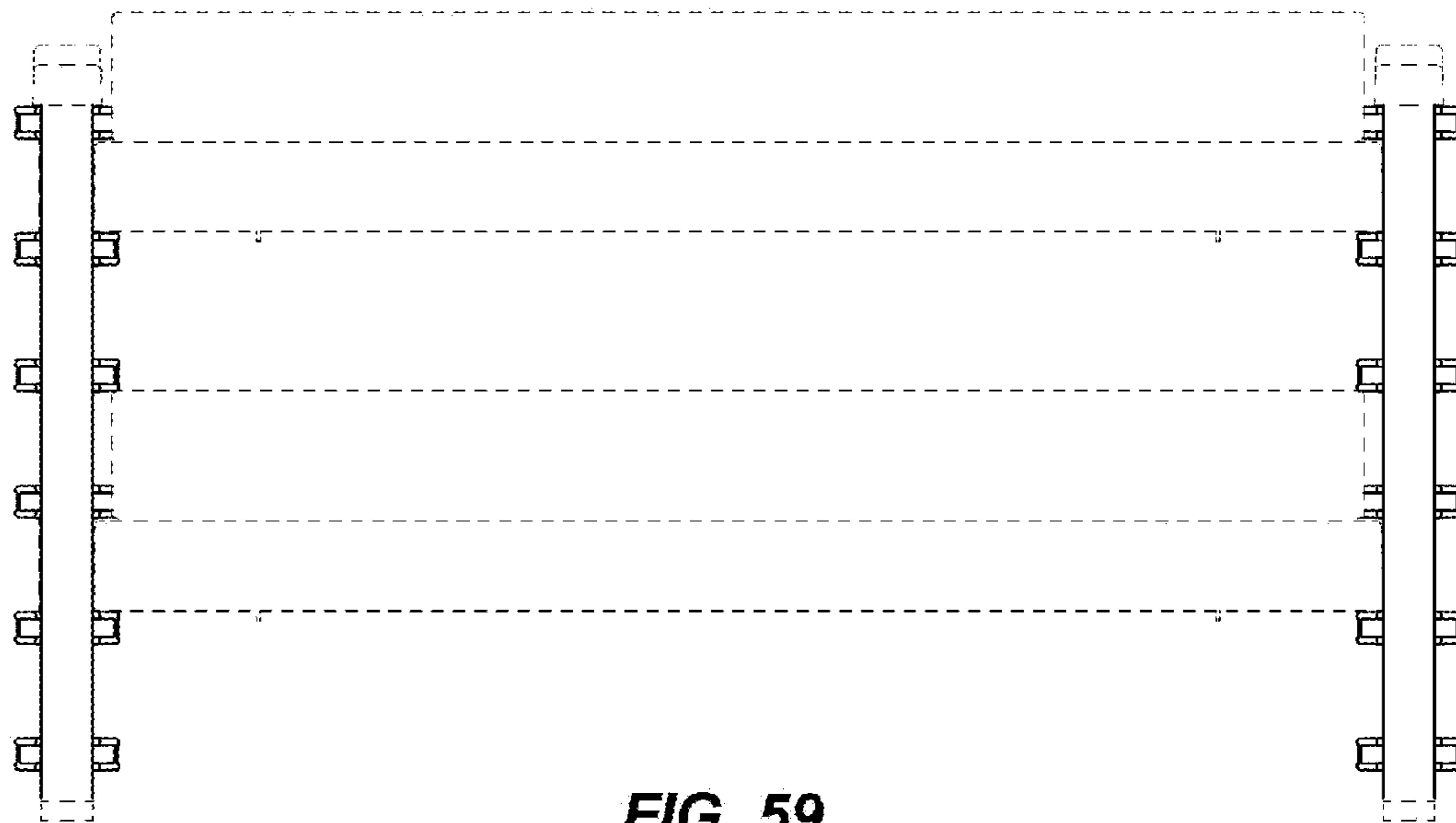

FIG. 59

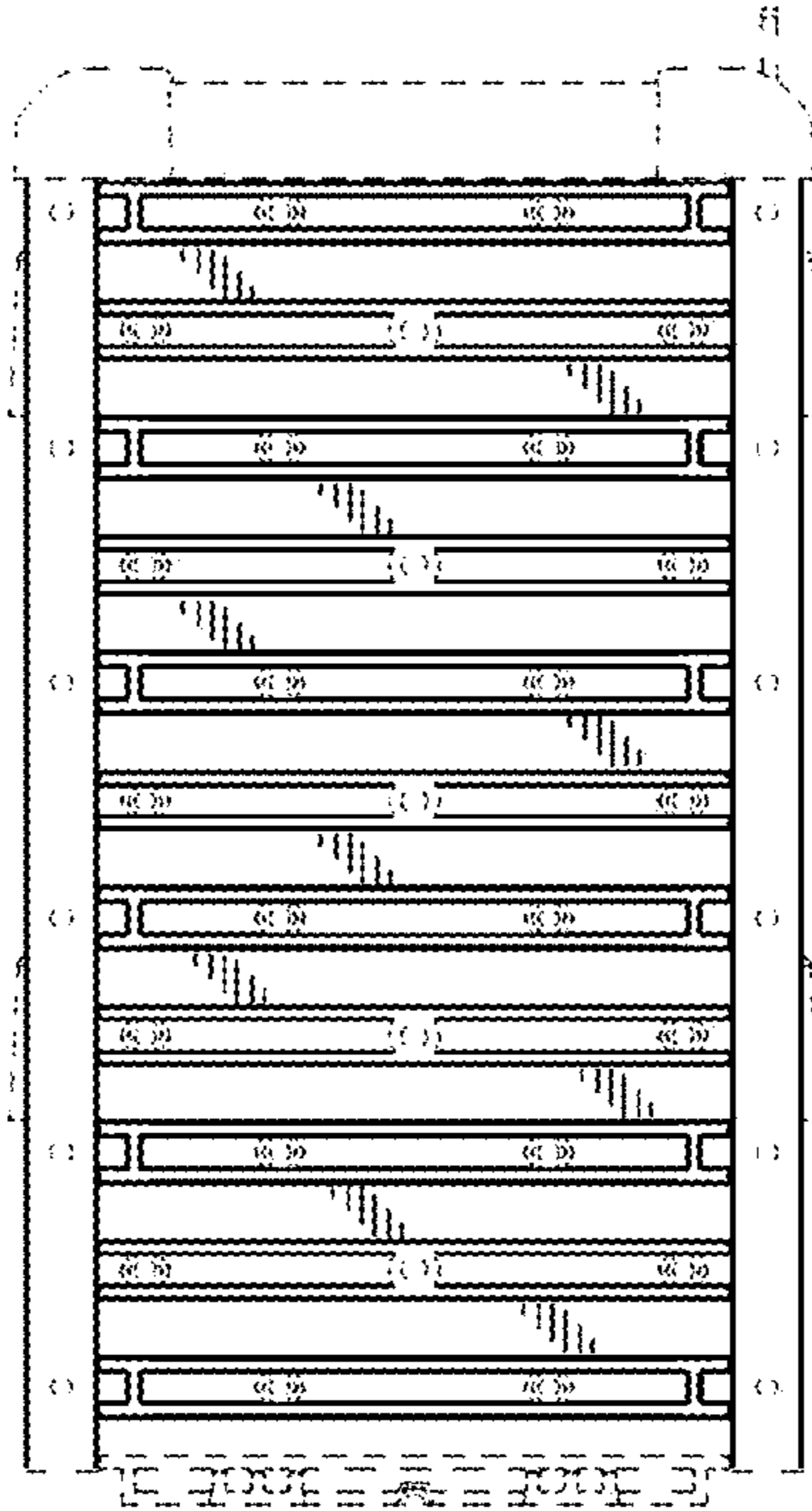

FIG. 60

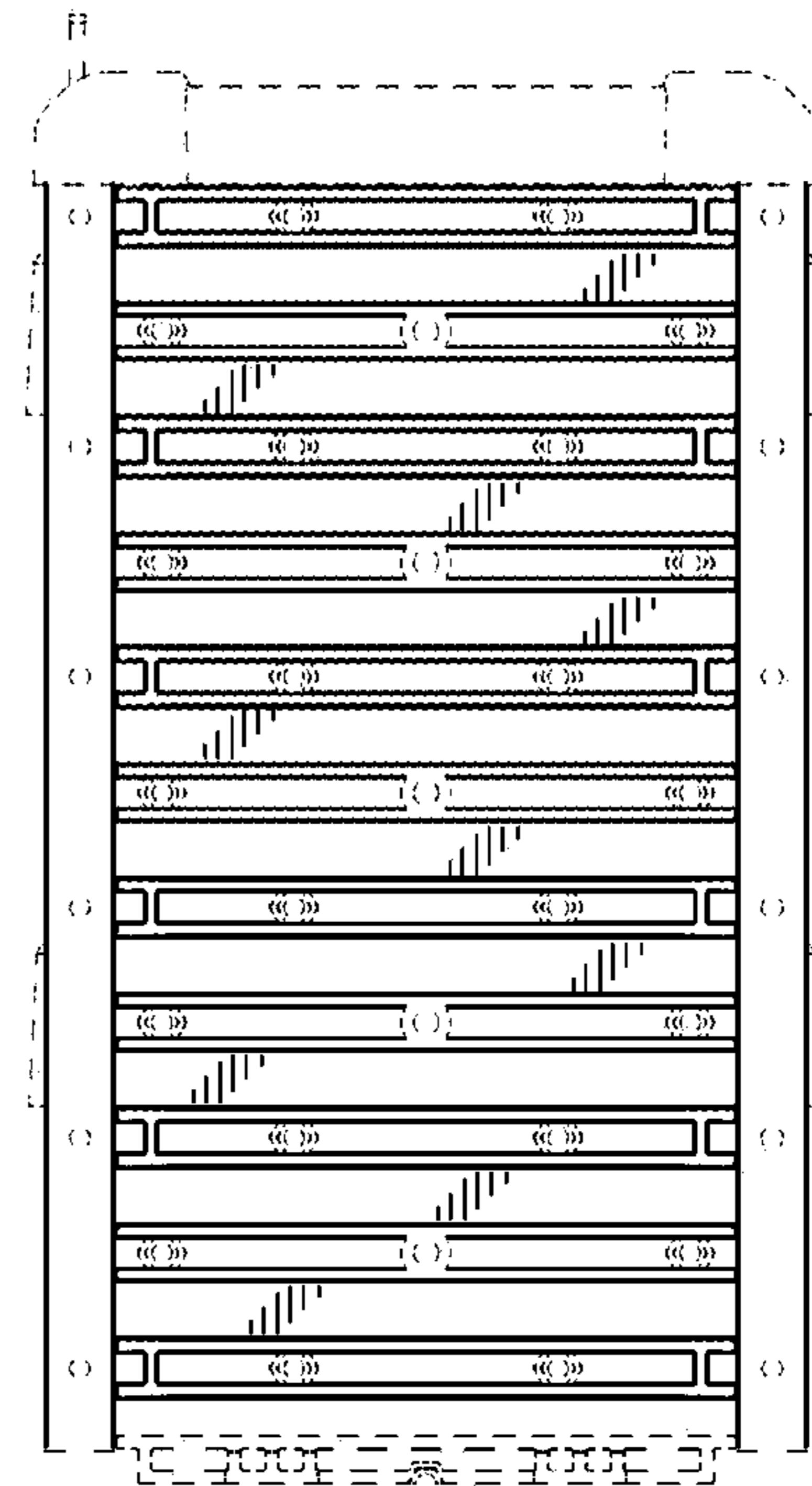

FIG. 61

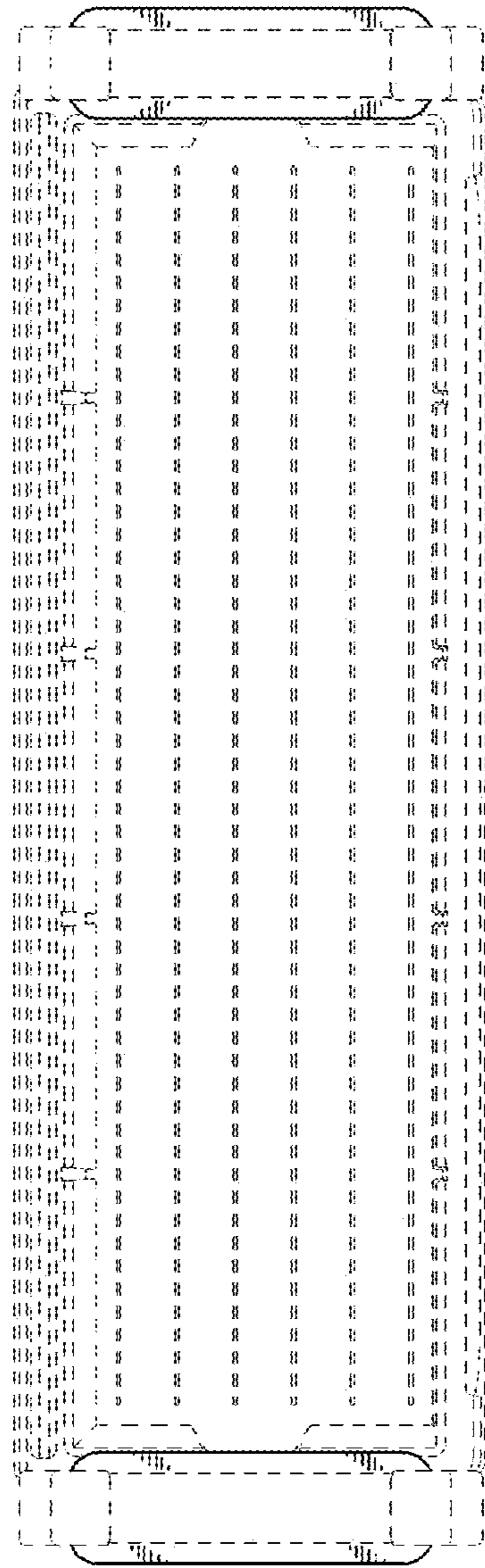

FIG. 62

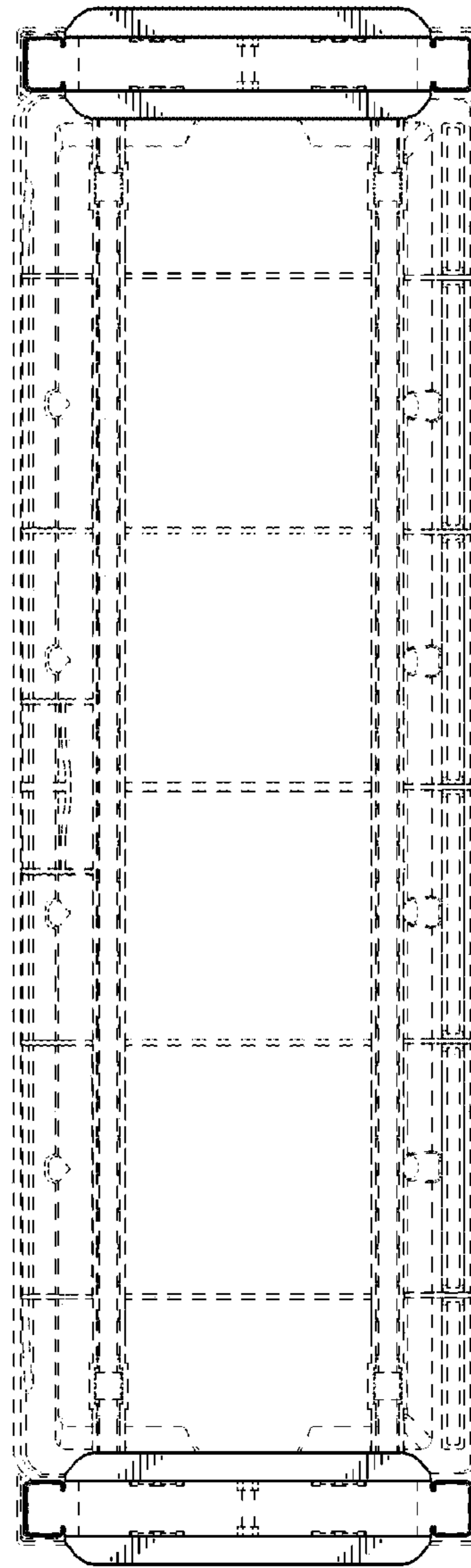

FIG. 63