



US00D745267S

(12) **United States Design Patent**  
**Ford et al.**

(10) **Patent No.:** **US D745,267 S**  
(45) **Date of Patent:** **\*\* Dec. 15, 2015**

- (54) **BACKPACK**
- (71) Applicant: **NIKE, Inc.**, Beaverton, OR (US)
- (72) Inventors: **Timothy John Ford**, Portland, OR (US);  
**Hrag Nassanian**, Beaverton, OR (US)
- (73) Assignee: **NIKE, Inc.**, Beaverton, OR (US)
- (\*\*) Term: **14 Years**
- (21) Appl. No.: **29/515,435**
- (22) Filed: **Jan. 22, 2015**
- (51) **LOC (10) Cl.** ..... **03-01**
- (52) **U.S. Cl.**  
USPC ..... **D3/217**
- (58) **Field of Classification Search**  
USPC ..... D3/201, 213-218, 231, 232, 267, 273,  
D3/289, 290, 318, 321, 327; 224/153  
CPC ..... A45F 3/04; A45F 4/02; A45F 3/02;  
A45F 3/08; A45F 3/047; A45C 9/00; A45C  
5/14; A45C 13/02; A45C 3/00; A45C 13/08;  
A41D 15/04  
See application file for complete search history.

(56) **References Cited**

**U.S. PATENT DOCUMENTS**

D409,376 S	5/1999	Golenz et al.	
D431,903 S	10/2000	Worley et al.	
D485,678 S	1/2004	Haro	
D485,987 S *	2/2004	Hassett	D3/267
D520,238 S *	5/2006	Montague	D3/290
D535,480 S *	1/2007	Fangman et al.	D3/321
D552,845 S	10/2007	Shor et al.	
D553,349 S	10/2007	Aliberti et al.	
D610,797 S	3/2010	Shor et al.	
D641,973 S	7/2011	Quehl	
D642,791 S	8/2011	Quehl	
D673,364 S *	1/2013	Webster	D3/232
D699,941 S *	2/2014	Robert	D3/216
D699,942 S	2/2014	Mather	

D699,943 S	2/2014	Mather	
D699,944 S	2/2014	Mather	
D706,534 S	6/2014	Zwetzig	
D708,845 S	7/2014	Taylor	
D731,181 S *	6/2015	Majeau et al.	D3/279
2007/0074941 A1 *	4/2007	Liang	190/107

**OTHER PUBLICATIONS**

NIKE Equipment Catalog, 2010 Holiday Equipment, p. 6, published Feb. 2010, NIKE, Inc., USA.  
 NIKE Equipment Catalog, 2010 Spring Accessories and Equipment, p. 19, published May 2009, NIKE, Inc., USA.  
 NIKE Equipment Catalog, 2010 Spring Basketball Equipment, p. 7, published May 2009, NIKE, Inc., USA.

\* cited by examiner

*Primary Examiner* — George D Kirschbaum

*Assistant Examiner* — Jennifer Watkins

(74) *Attorney, Agent, or Firm* — Banner & Witcoff, Ltd.

(57) **CLAIM**

The ornamental design for a backpack, as shown and described.

**DESCRIPTION**

FIG. 1 is a top, front, right perspective view of a backpack showing our new design;  
 FIG. 2 is a top front, left perspective view thereof;  
 FIG. 3 is a front view thereof;  
 FIG. 4 is a left side view thereof;  
 FIG. 5 is a right side view thereof;  
 FIG. 6 is a top view thereof; and,  
 FIG. 7 is top, front, left perspective view of the backpack shown in an alternate configuration.  
 The uneven-length broken lines immediately adjacent to the shaded area represent unclaimed boundaries of the claimed design. The even-length broken lines showing the Remainder of the backpack are for environmental purposes only and form no part of the claimed design.

**1 Claim, 7 Drawing Sheets**

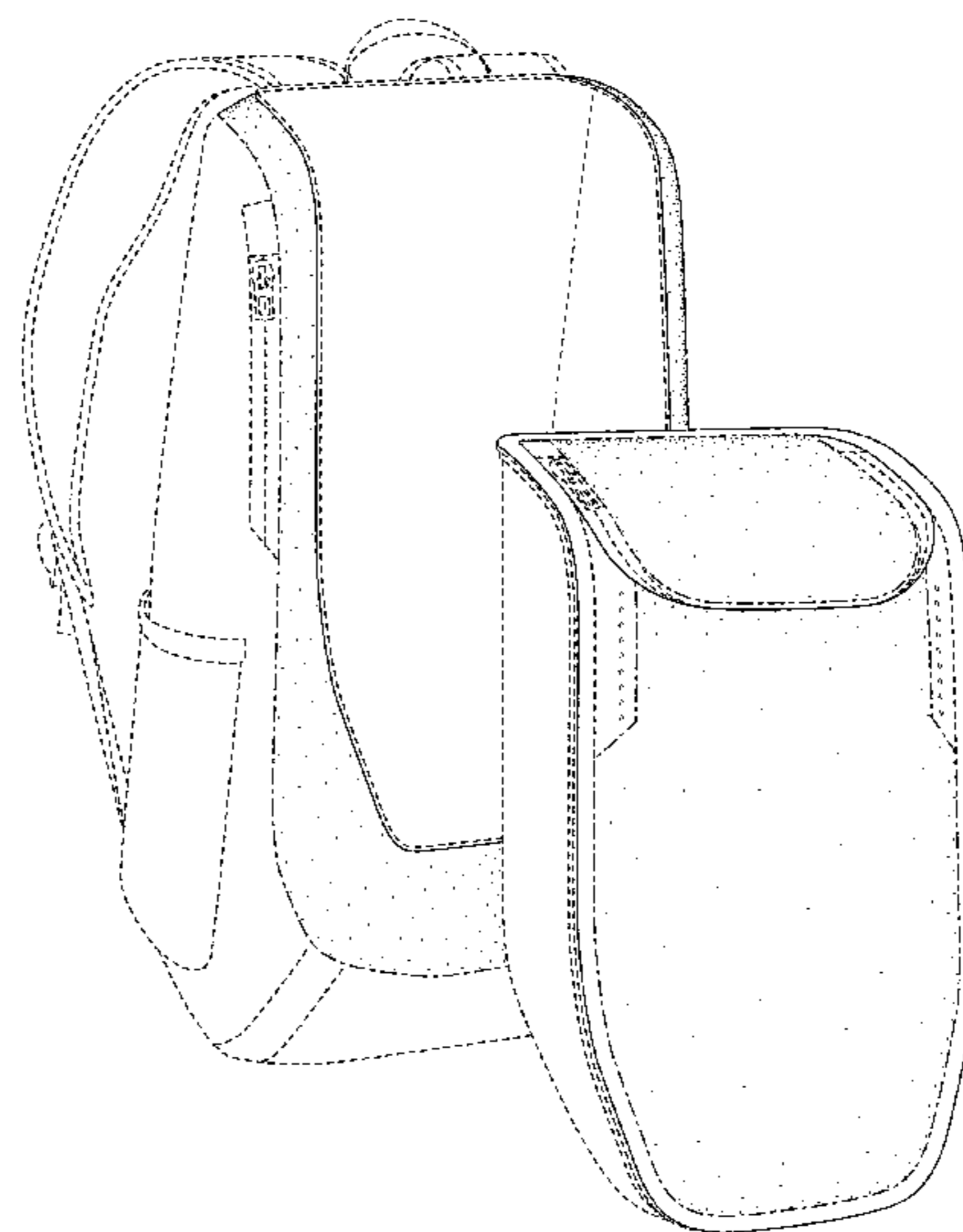
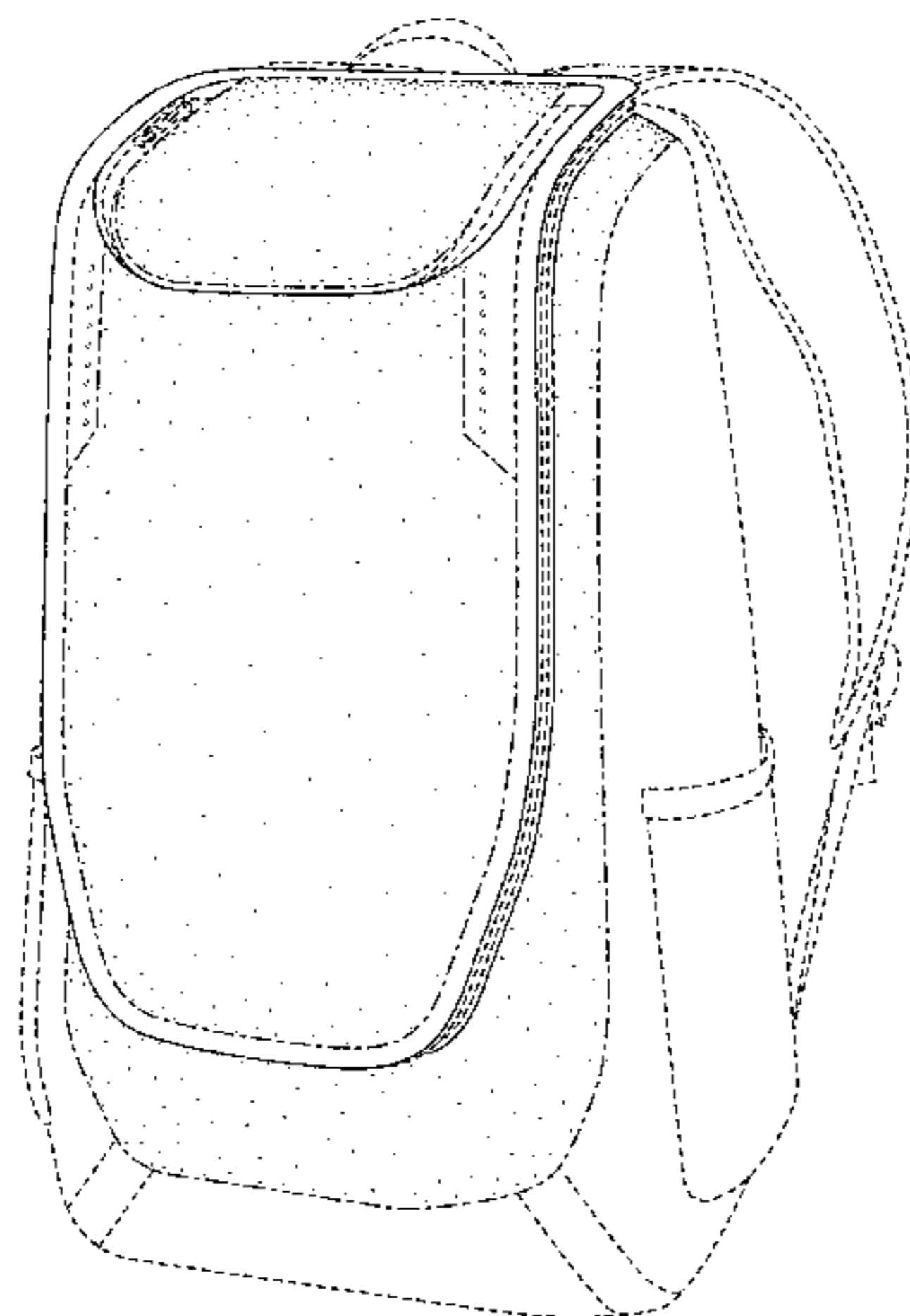

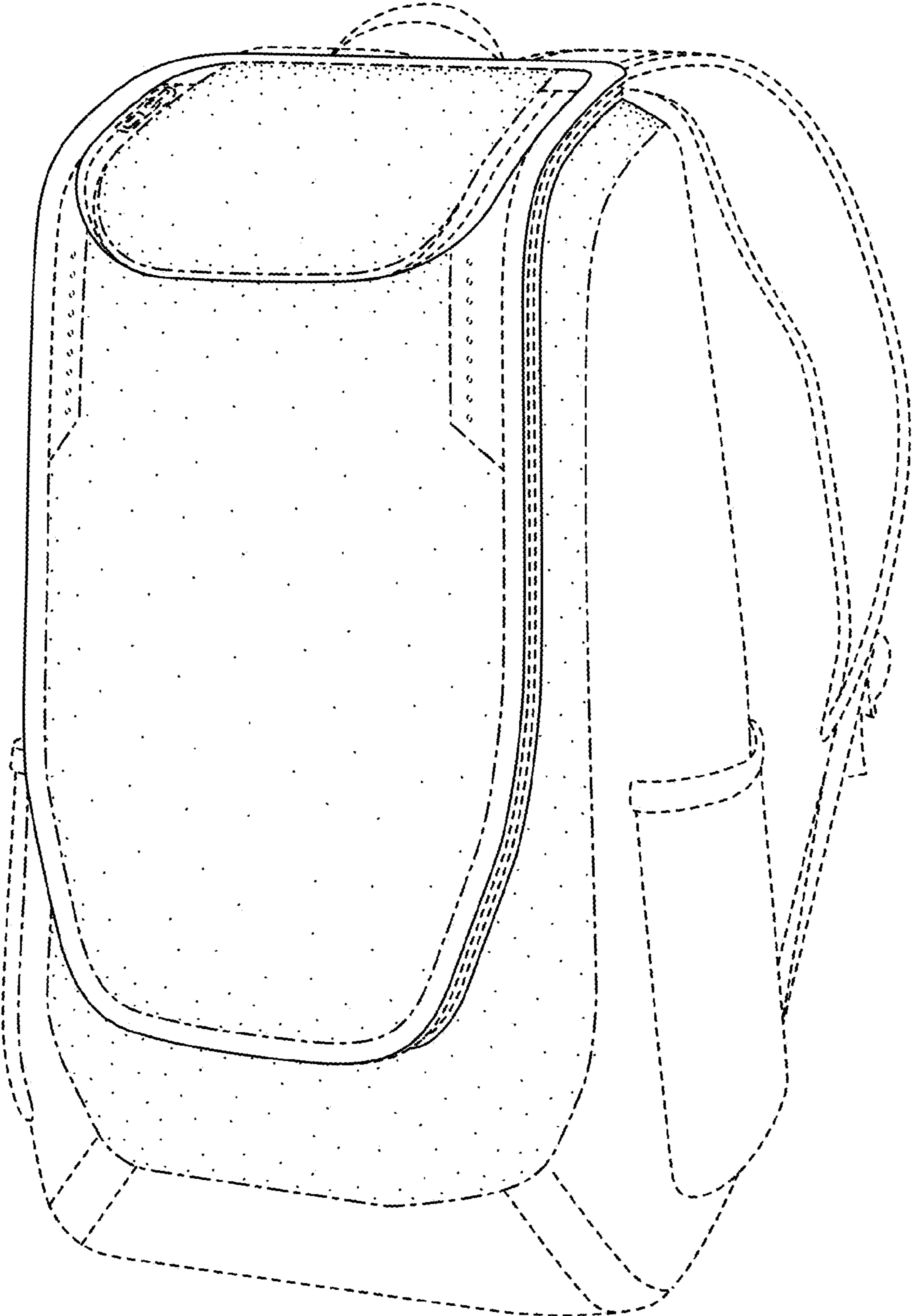

FIG. 1

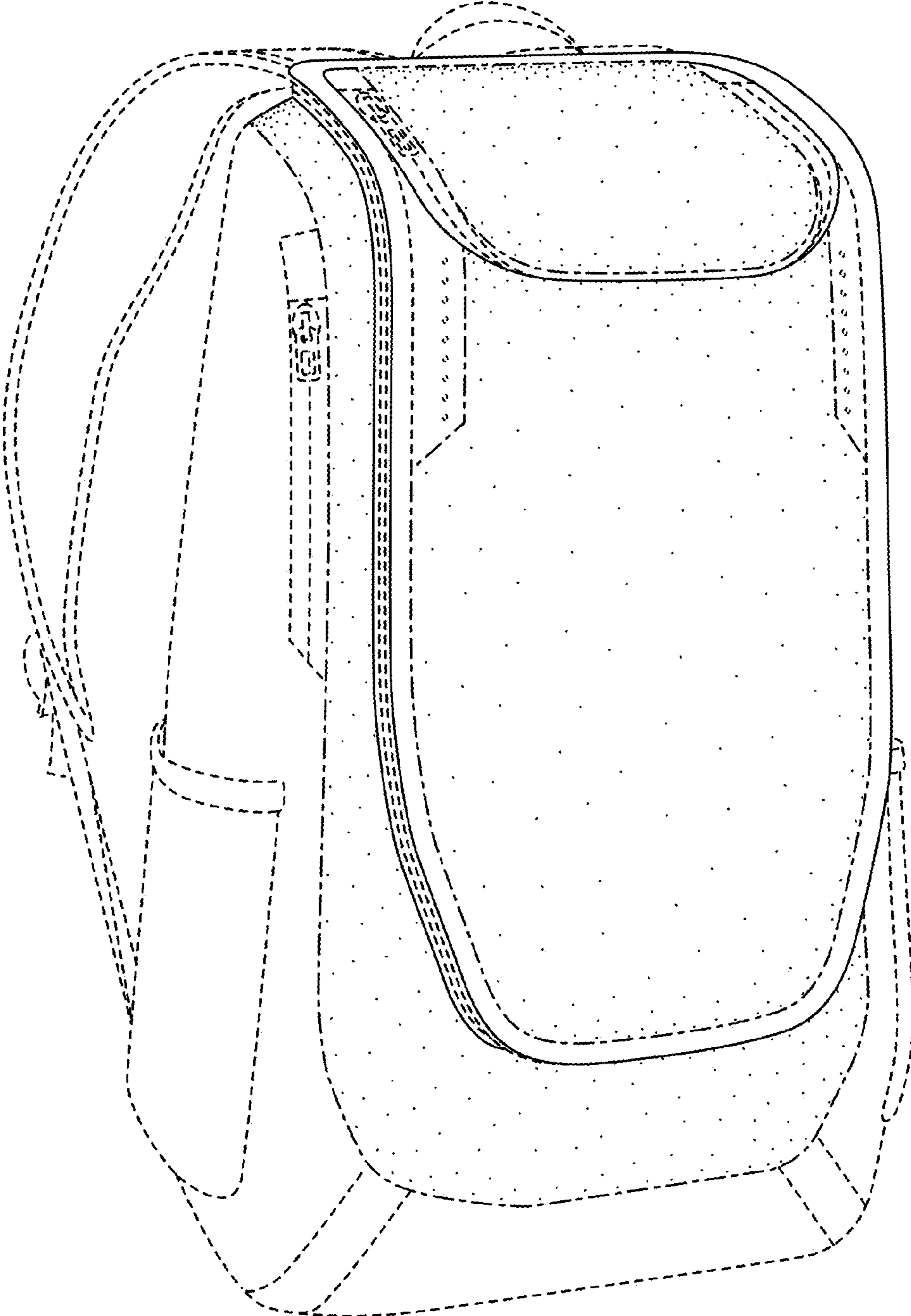

FIG. 2

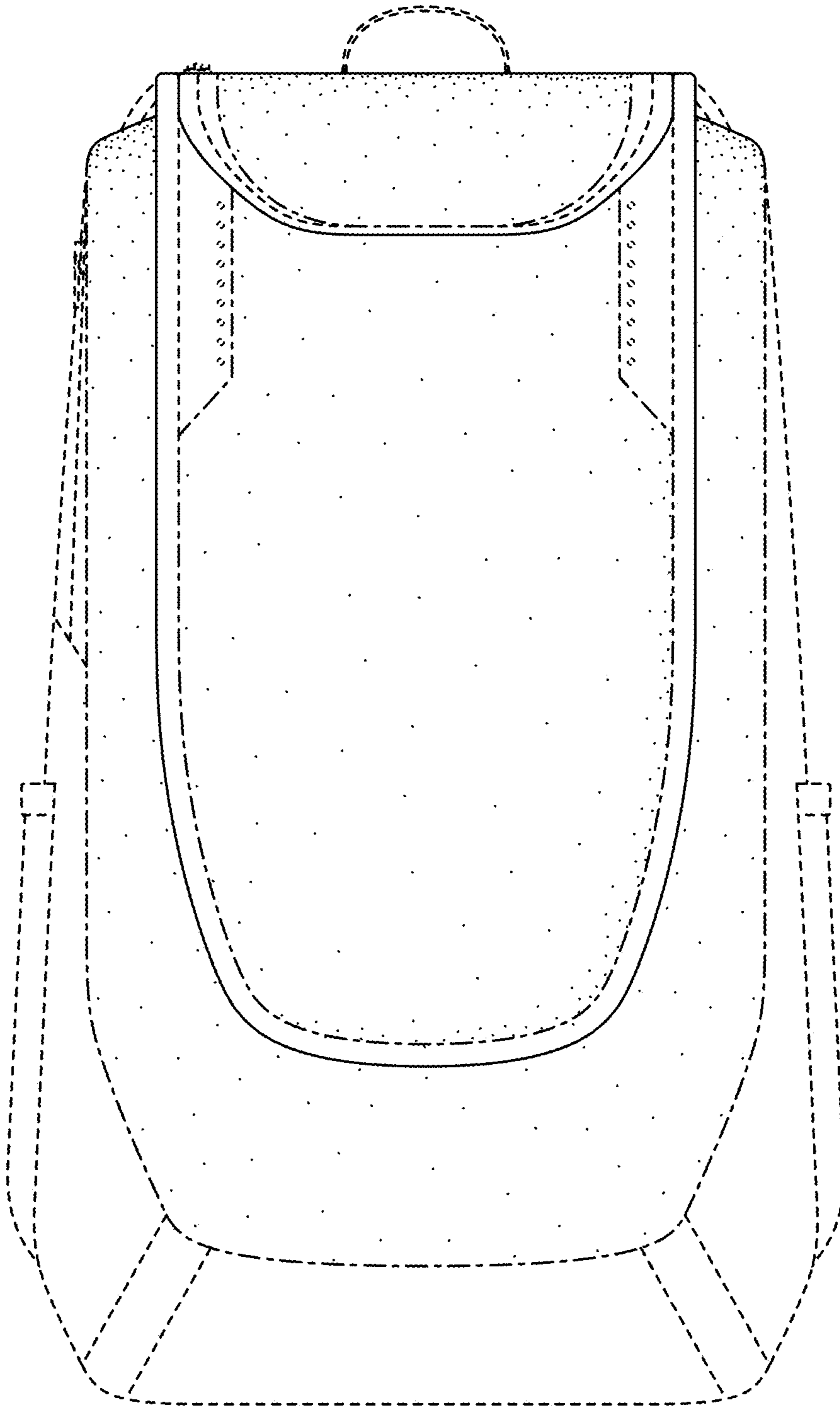

FIG. 3

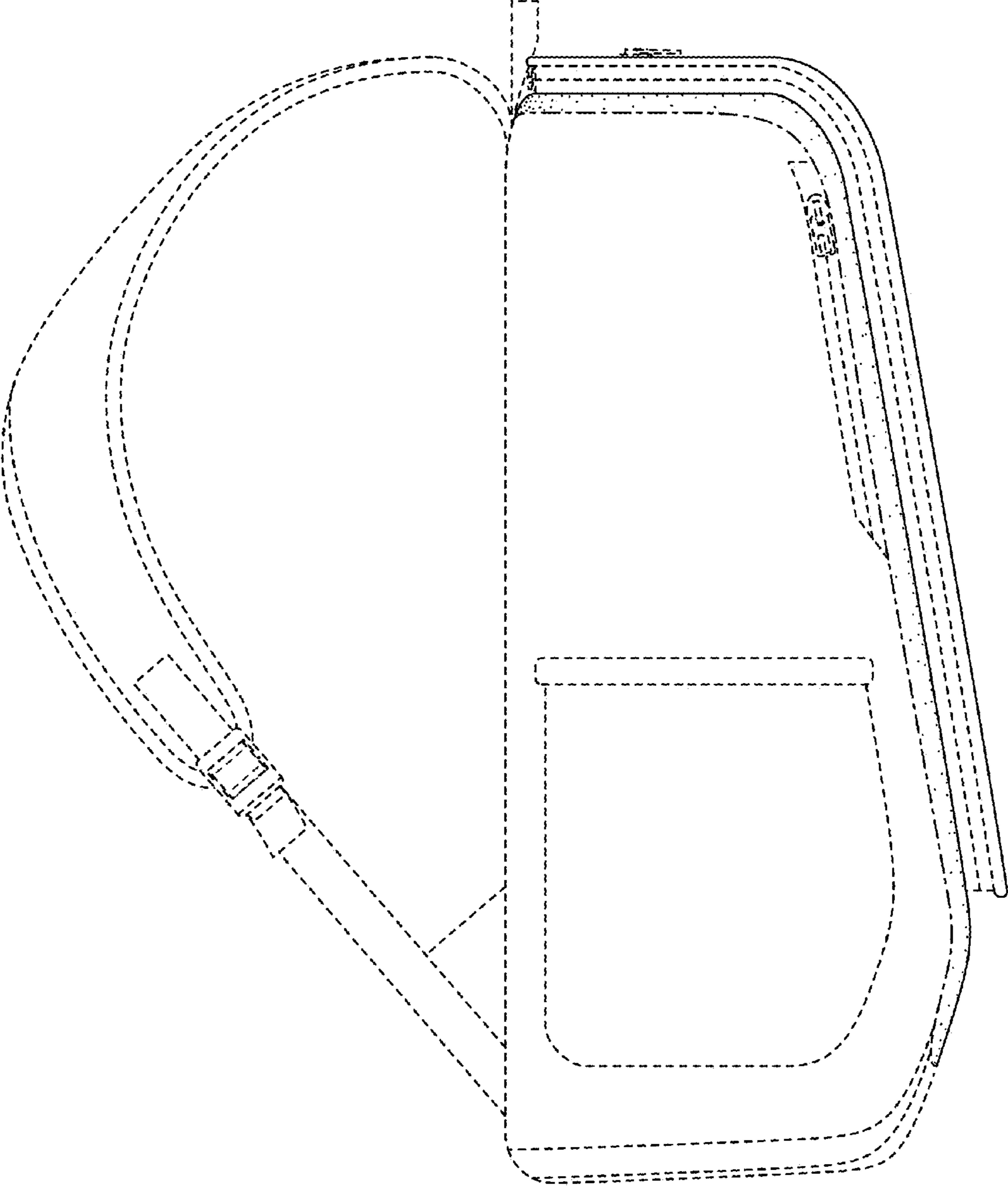

FIG. 4

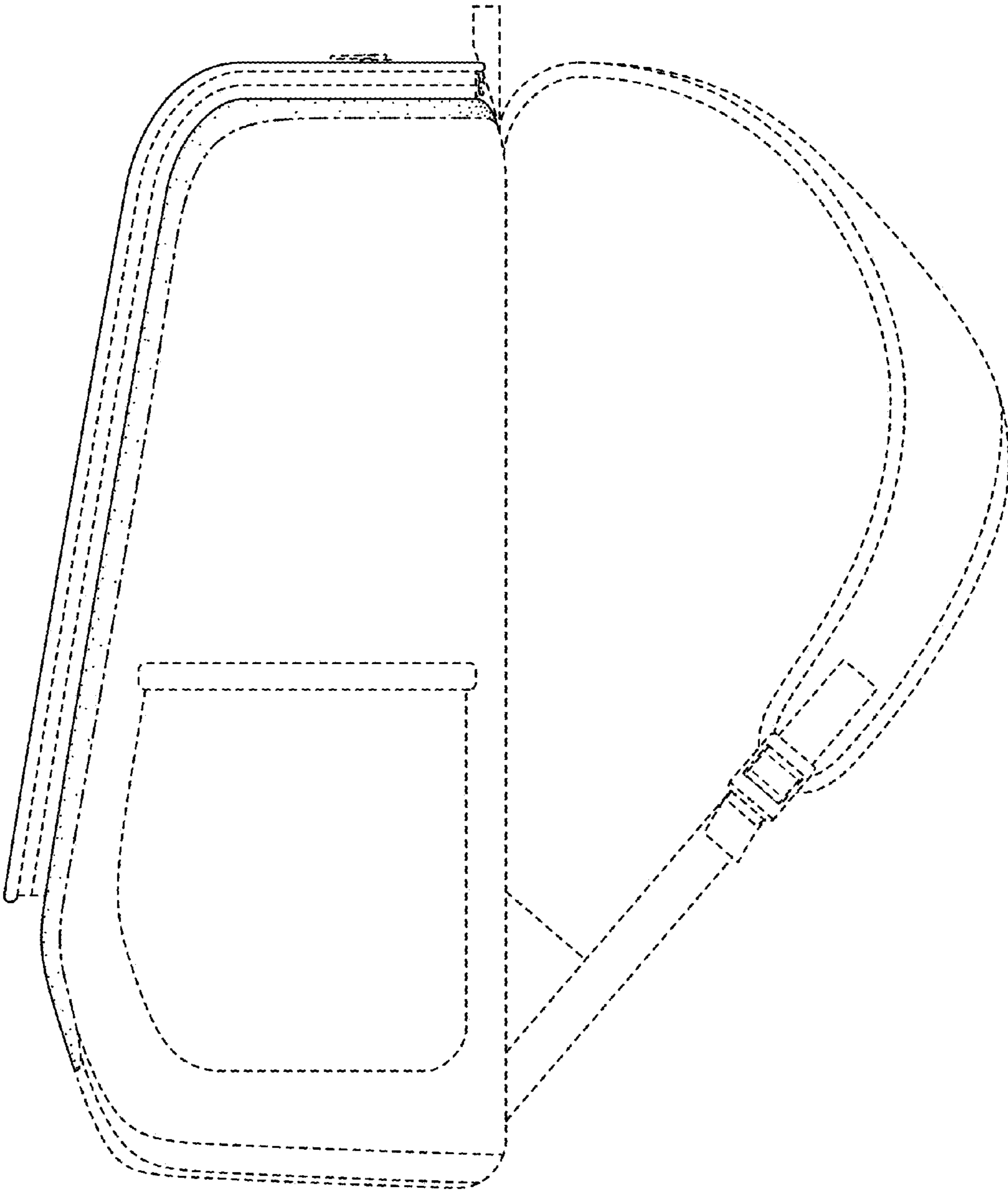

FIG. 5

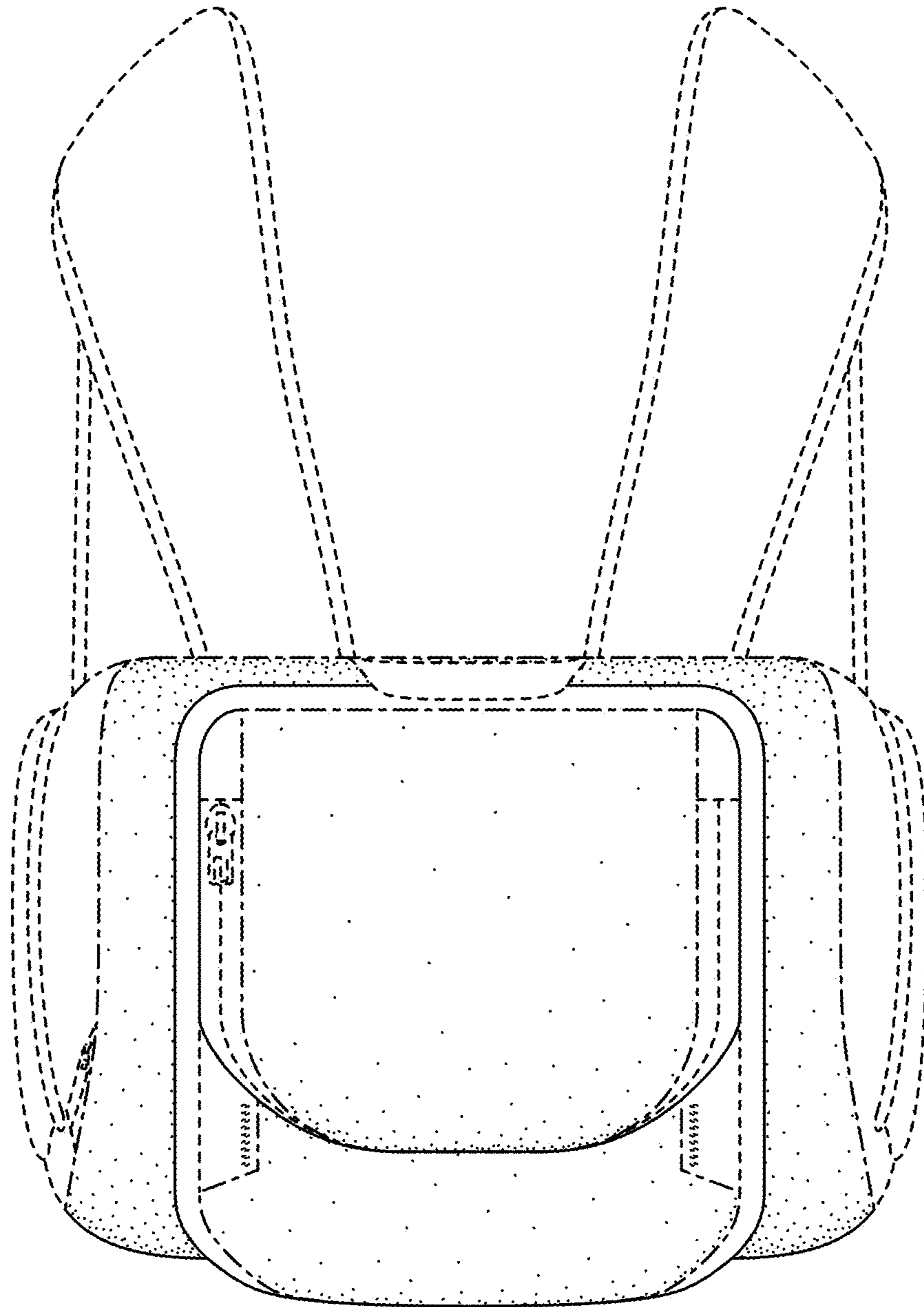

FIG. 6

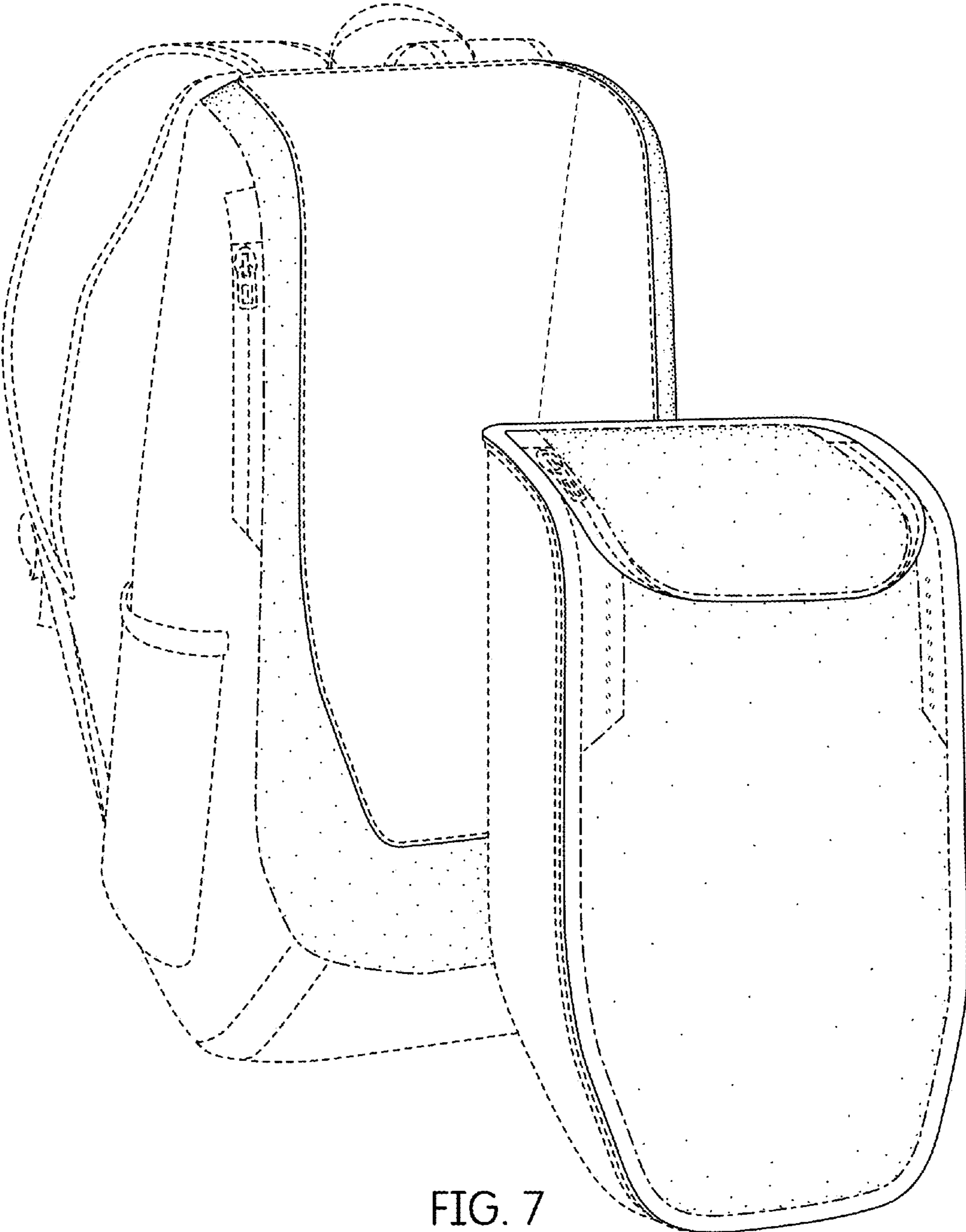

FIG. 7