



US00D745075S

(12) **United States Design Patent**  
**Ive et al.**

(10) **Patent No.:** **US D745,075 S**  
(45) **Date of Patent:** **\*\* Dec. 8, 2015**

(54) **CAMERA**

(71) Applicants: **Jonathan P. Ive**, San Francisco, CA  
(US); **Marc A. Newson**, London (GB)

(72) Inventors: **Jonathan P. Ive**, San Francisco, CA  
(US); **Marc A. Newson**, London (GB)

(\*\*) Term: **15 Years**

(21) Appl. No.: **29/530,717**

(22) Filed: **Jun. 18, 2015**

**Related U.S. Application Data**

(63) Continuation of application No. 29/469,268, filed on  
Oct. 8, 2013, now Pat. No. Des. 732,595.

(51) **LOC (10) Cl.** ..... **16-01**

(52) **U.S. Cl.**  
USPC ..... **D16/202**

(58) **Field of Classification Search**  
USPC ..... D16/200, 202–206, 208–209, 218, 219;  
348/373–376; 396/535, 539–541  
CPC ..... G03B 15/03; G03B 17/02; G03B 17/04;  
G03B 17/56; G03B 19/04; H04N 5/2251;  
H04N 5/2252; H04N 5/2253; H04N 5/2254;  
H04N 2101/00

See application file for complete search history.

(56) **References Cited**

**U.S. PATENT DOCUMENTS**

D359,299 S	6/1995	Moro et al.	
D383,146 S	9/1997	Hashimoto et al.	
D383,147 S	9/1997	Moro et al.	
5,950,028 A *	9/1999	Ito	396/349
D469,456 S	1/2003	Nakamura et al.	
D473,576 S *	4/2003	Watanabe	D16/202
D479,547 S	9/2003	Nagayama	
D525,639 S	7/2006	Nakamura	
D537,093 S	2/2007	Nakamura	
D537,460 S	2/2007	Nakamura et al.	

D550,736 S	9/2007	Sakai	
D555,688 S	11/2007	Yoo et al.	
D556,802 S	12/2007	Katayama	
D559,292 S	1/2008	Imai	
D560,236 S *	1/2008	Yoshida	D16/202
D560,237 S *	1/2008	Yoshida	D16/202

(Continued)

**OTHER PUBLICATIONS**

Leica Camera AG, “Leica M Monochrom,” accessed at [http://us.leica-camera.com/photography/m\\_system/m\\_monochrom/](http://us.leica-camera.com/photography/m_system/m_monochrom/), accessed on Apr. 10, 2014, 2 pages.

(Continued)

*Primary Examiner* — Adir Aronovich

*Assistant Examiner* — Ramzi Almatrahi

(74) *Attorney, Agent, or Firm* — Sterne, Kessler, Goldstein & Fox P.L.L.C.

(57) **CLAIM**

The ornamental design for a camera, as shown and described.

**DESCRIPTION**

The patent and application file contain drawings executed in color. Copies of this patent or patent application publication with color drawings will be provided by the Office upon request and payment of the necessary fee.

FIG. 1 is a top front perspective view of a camera showing our new design;

FIG. 2 is a front view thereof;

FIG. 3 is a rear view thereof;

FIG. 4 is a left side view thereof;

FIG. 5 is a right side view thereof;

FIG. 6 is a bottom view thereof; and,

FIG. 7 is a top view thereof.

The dot-dash lines in the Figures and the area within the dot-dash lines depict portions of the camera in which the design is embodied and form no part of the claimed design.

**1 Claim, 7 Drawing Sheets**  
**(5 of 7 Drawing Sheet(s) Filed in Color)**

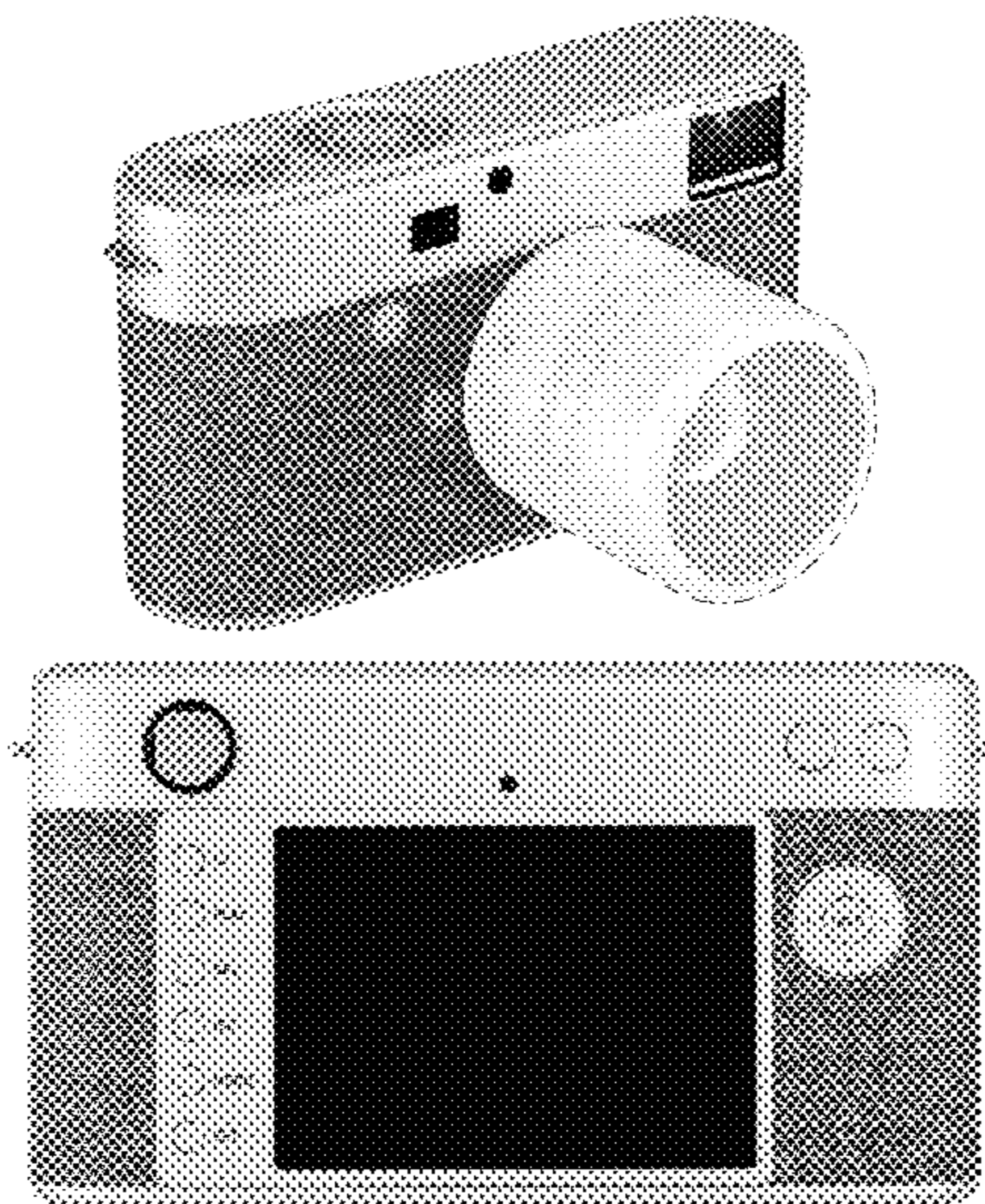

(56)

**References Cited**

U.S. PATENT DOCUMENTS

D561,218	S *	2/2008	Kim .....	D16/202
D576,650	S *	9/2008	Shibata et al. ....	D16/202
7,524,118	B2 *	4/2009	Maeda .....	396/349
D596,217	S *	7/2009	Kim et al. ....	D16/219
D597,576	S	8/2009	Kim et al.	
D597,578	S *	8/2009	Kim et al. ....	D16/202
D603,886	S	11/2009	Sakai	
D697,959	S	1/2014	Imai	
D702,748	S	4/2014	Muraki et al.	
D726,238	S *	4/2015	Izumi et al. ....	D16/219
D734,800	S *	7/2015	Ive et al. ....	D16/202
2007/0212062	A1 *	9/2007	Saiki et al. ....	396/535

OTHER PUBLICATIONS

Leica Camera AG, "Leica M," accessed at [http://us.leica-camera.com/photography/m\\_system/m\\_new/](http://us.leica-camera.com/photography/m_system/m_new/), accessed on Apr. 10, 2014, 3 pages.

Leica Camera AG, "Leica M7," accessed at [http://us.leica-camera.com/photography/m\\_system/m7/](http://us.leica-camera.com/photography/m_system/m7/), accessed on Apr. 10, 2014, 2 pages.

Leica Camera AG, "The Leica M9 and M9-P," accessed at [http://us.leica-camera.com/photography/m\\_system/m9/](http://us.leica-camera.com/photography/m_system/m9/), accessed on Apr. 10, 2014, 2 pages.

Leica Camera AG, "Leica M9-P 'Edition Hermes,'" accessed at [http://us.leica-camera.com/photography/special\\_editions/m9\\_edition\\_hermes/](http://us.leica-camera.com/photography/special_editions/m9_edition_hermes/), accessed on Apr. 10, 2014, 2 pages.

Leica Camera AG, "Leica M-E," accessed at [http://us.leica-camera.com/photography/m\\_system/m-e/](http://us.leica-camera.com/photography/m_system/m-e/), accessed on Apr. 10, 2014, 2 pages.

Leica Camera AG, "Leica MP," accessed at [http://us.leica-camera.com/photography/m\\_system/mp/](http://us.leica-camera.com/photography/m_system/mp/), accessed on Apr. 10, 2014, 1 page.

Leica Camera AG, "X a la carte," accessed at [http://us.leica-camera.com/photography/compact\\_cameras\\_x\\_a\\_la\\_carte/](http://us.leica-camera.com/photography/compact_cameras_x_a_la_carte/), accessed on Apr. 10, 2014, 2 pages.

Leica Camera AG, "Leica X2 Edition Paul Smith," accessed at [http://us.leica-camera.com/compact\\_cameras\\_x2-edition\\_paul\\_smith/](http://us.leica-camera.com/compact_cameras_x2-edition_paul_smith/), accessed on Apr. 10, 2014, 2 pages.

Leica Camera AG, "Leica X2," accessed at [http://us.leica-camera.com/photography/compact\\_cameras/x2/](http://us.leica-camera.com/photography/compact_cameras/x2/), accessed on Apr. 10, 2014, 2 pages.

Crisp, Simon, "Leica reveals the Leica M and the stripped back M-E," accessed at <http://www.gizmag.com/leica-m-and-m-e/24247/>, dated Sep. 23, 2012, 6 pages.

\* cited by examiner

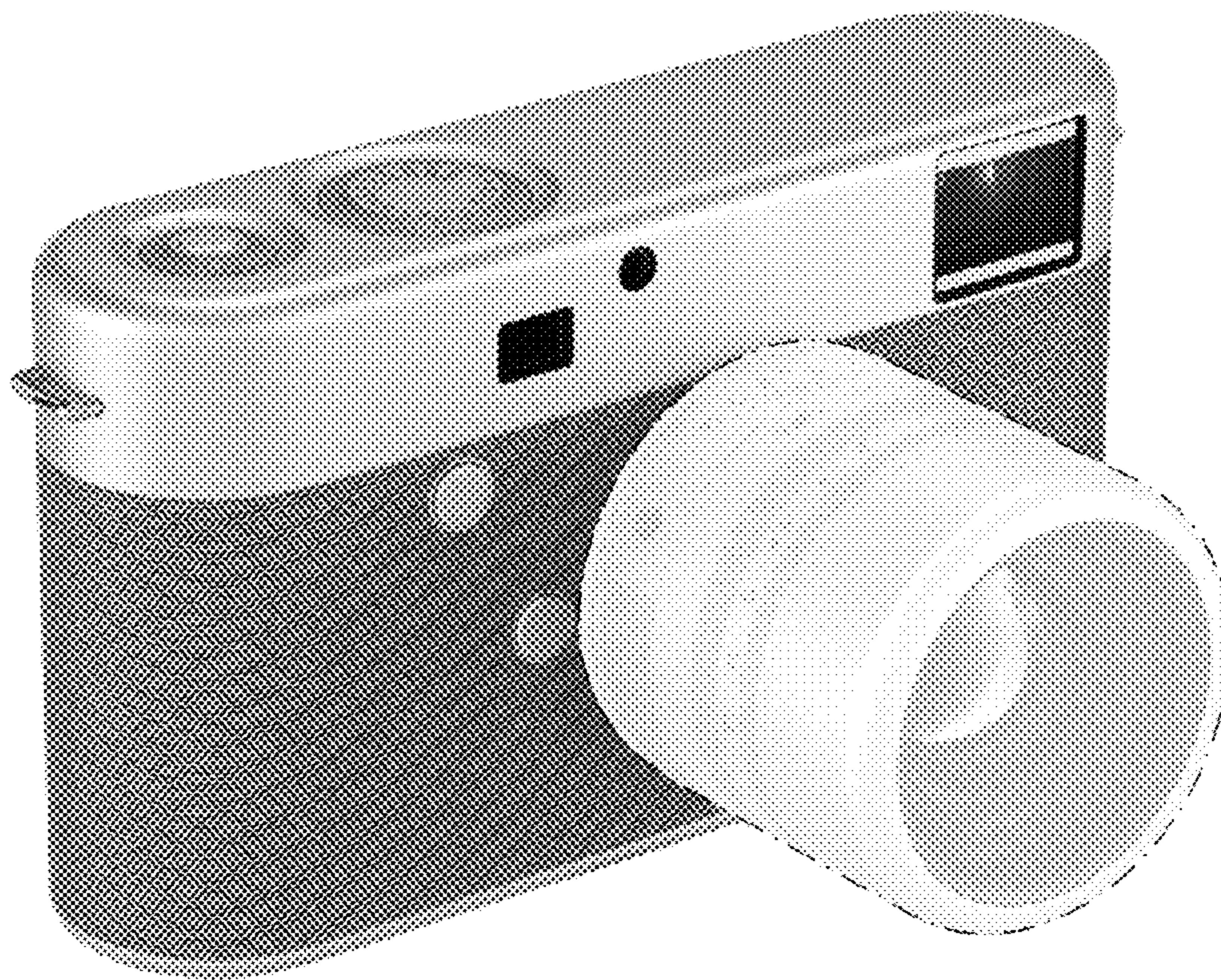

FIG. 1

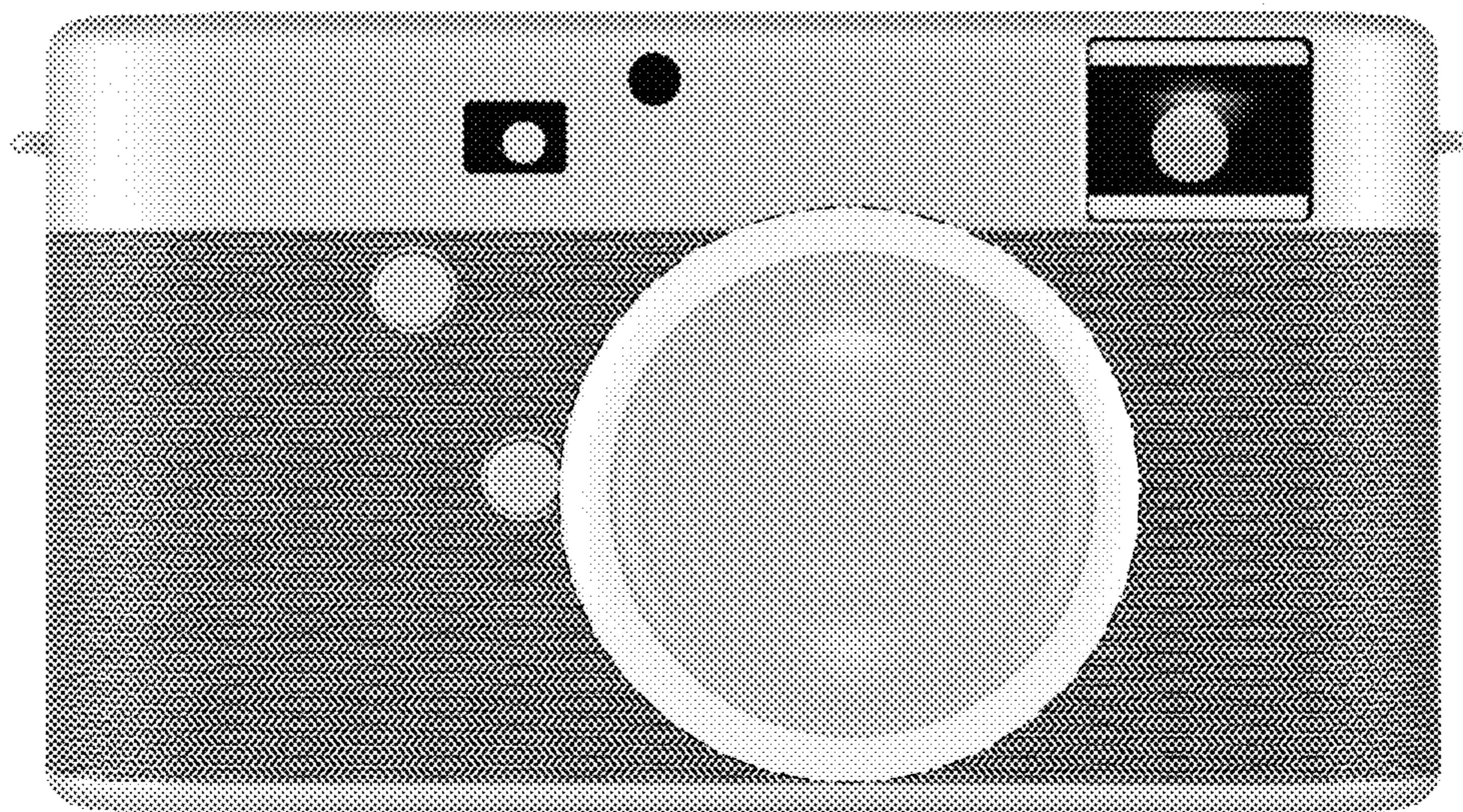

FIG. 2

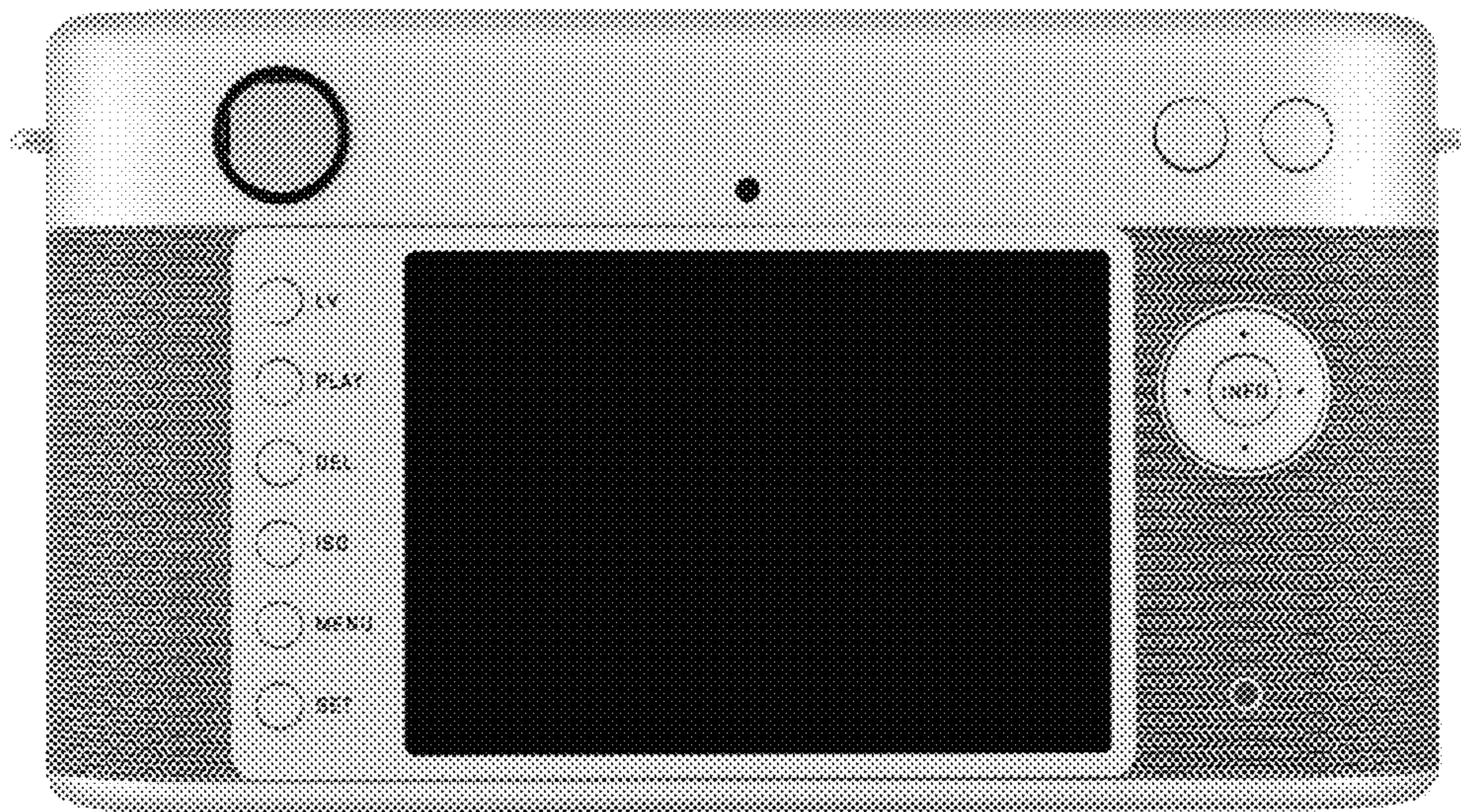
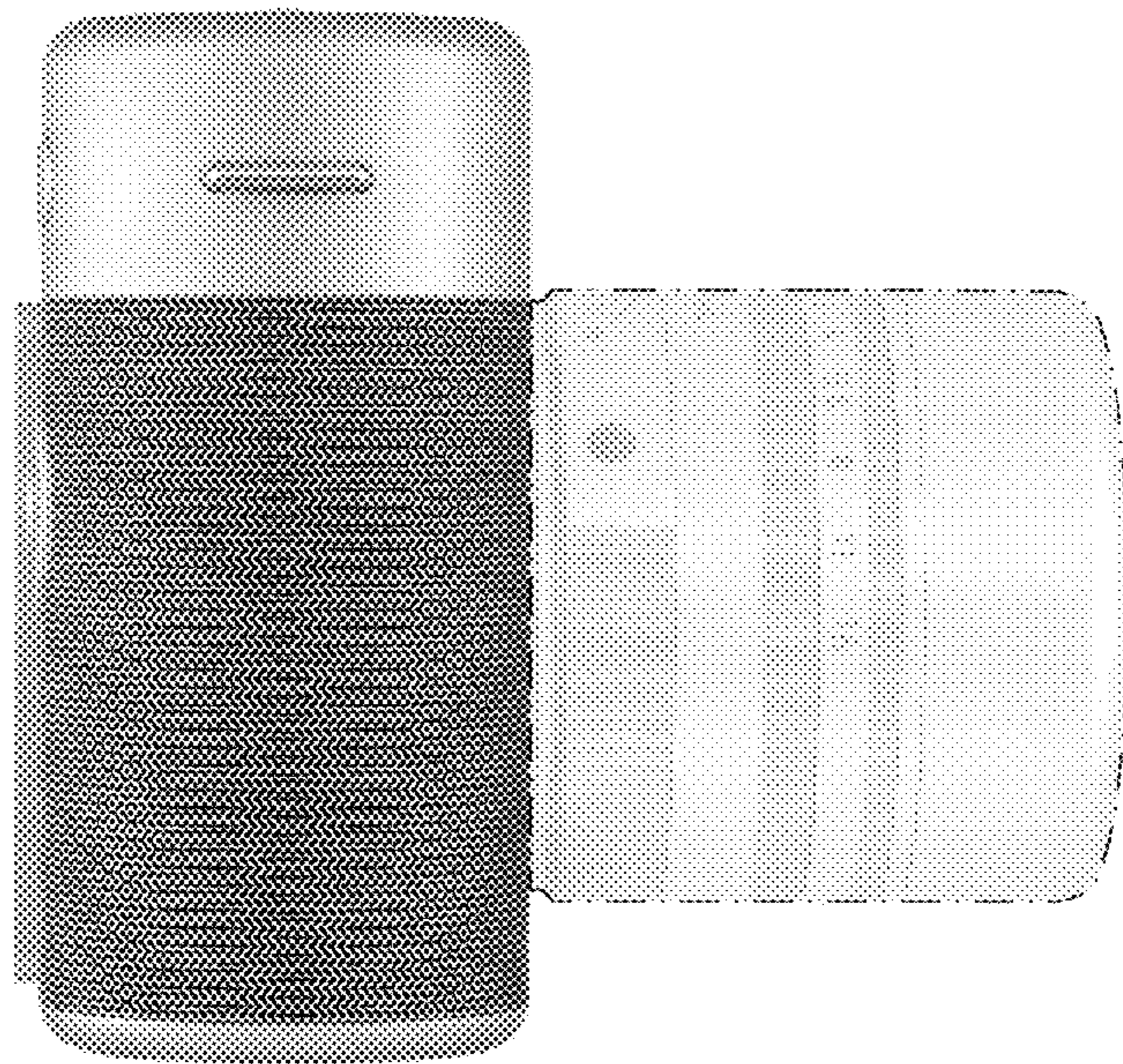

FIG. 3



**FIG. 4**

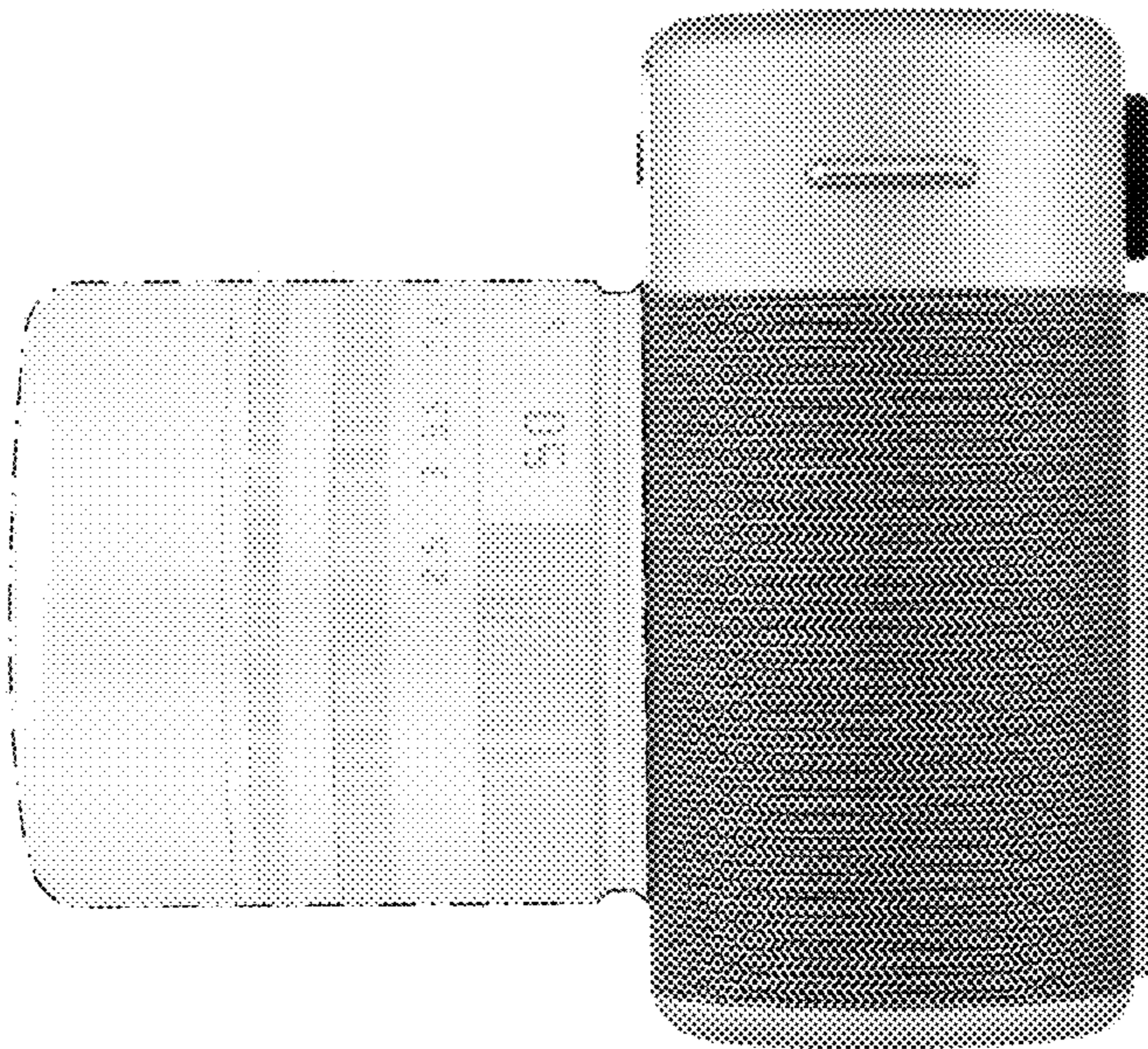
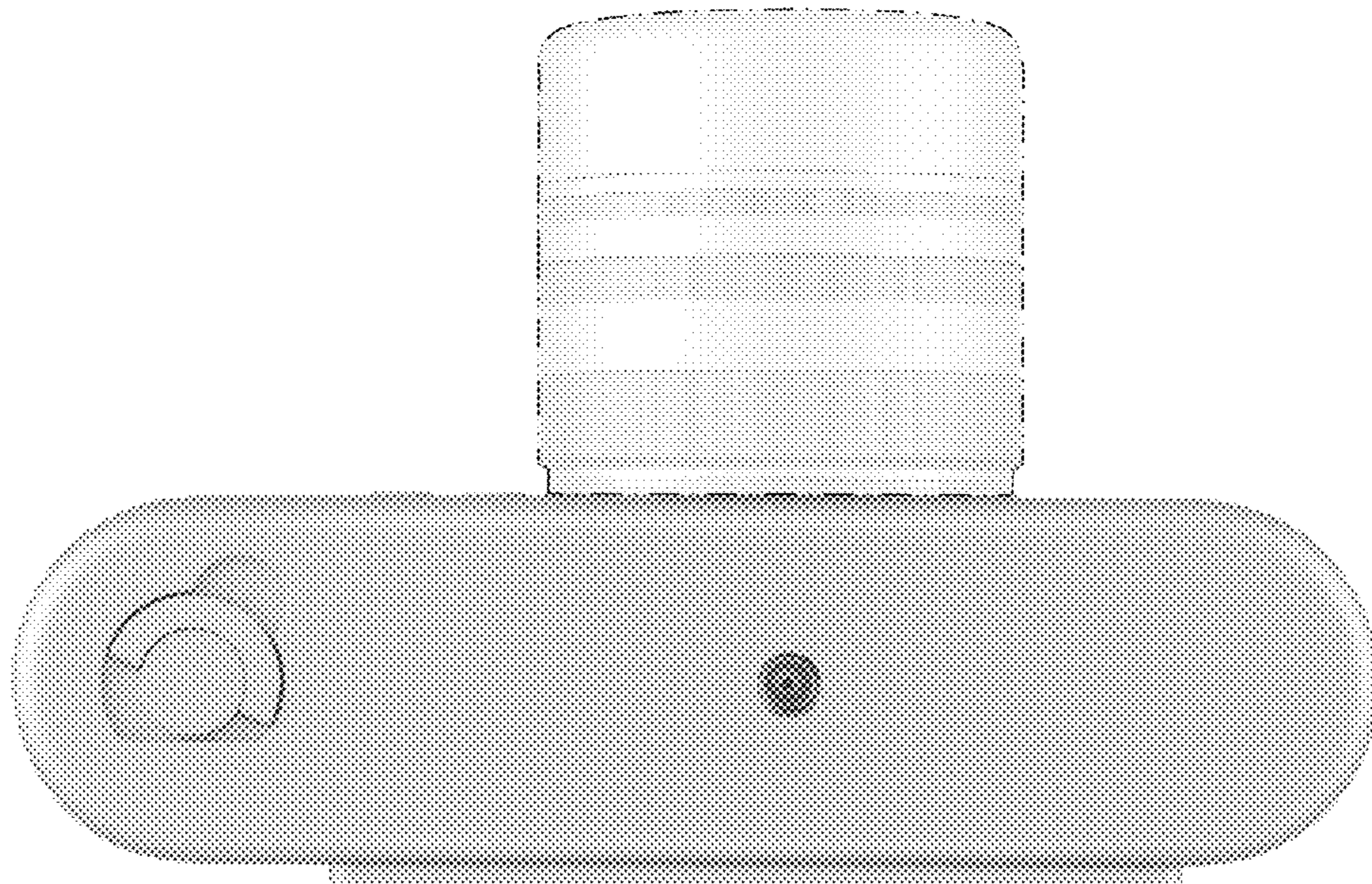

FIG. 5



**FIG. 6**



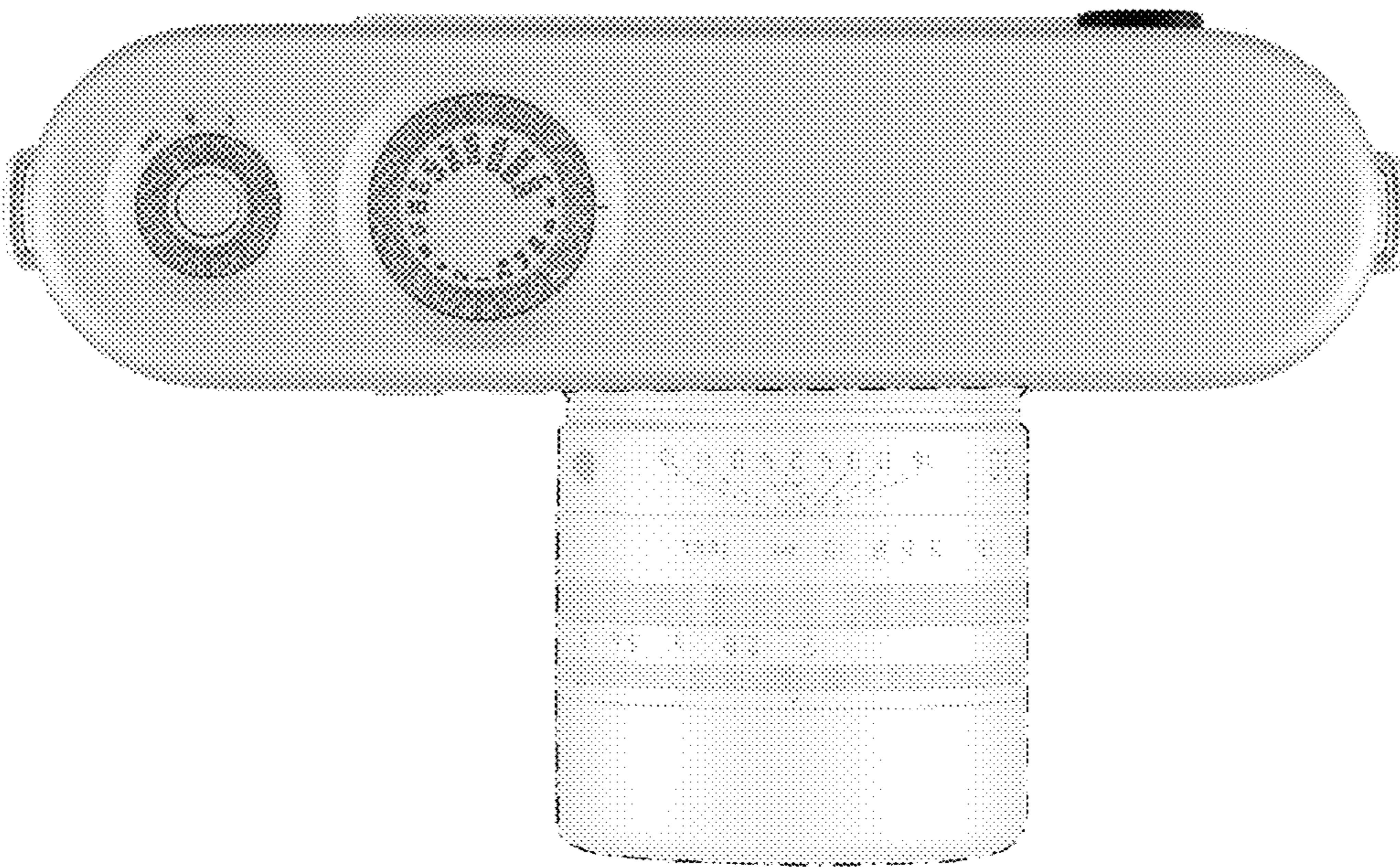

FIG. 7