



US00D744983S

(12) **United States Design Patent**
Rogers et al.

(10) **Patent No.:** **US D744,983 S**
(45) **Date of Patent:** **** Dec. 8, 2015**

(54) **AUDIO EQUIPMENT**

H04H 60/91; H04R 3/00; H04R 3/005;
H04R 5/04; H04R 2205/021; H04R 2499/11
See application file for complete search history.

(71) Applicant: **Allen & Heath Limited**, Cornwall (GB)

(72) Inventors: **Glenn Rogers**, Cornwall (GB); **Robin Clark**, Cornwall (GB); **Mike Williamson**, Cornwall (GB); **Carey Davies**, Cornwall (GB); **James Wrigley**, Cornwall (GB); **Alex Money**, Cornwall (GB); **John Danning**, Cornwall (GB); **David Price**, Cornwall (GB); **Ian McBurney**, Cornwall (GB); **Simon Trethewey**, Cornwall (GB); **David Cook**, Cornwall (GB); **David Biggs**, Cornwall (GB); **Niall Dunican**, Cornwall (GB); **Chris Lock**, Cornwall (GB)

(56) **References Cited**

U.S. PATENT DOCUMENTS

| | | |
|------------|---------|---------------|
| D270,740 S | 9/1983 | Pearson |
| D291,196 S | 8/1987 | Ito et al. |
| D380,760 S | 7/1997 | Mackie et al. |
| D399,207 S | 10/1998 | Mackie et al. |
| D399,208 S | 10/1998 | Mackie et al. |
| D401,242 S | 11/1998 | Mackie et al. |
| D499,394 S | 12/2004 | Suzuki |
| D532,774 S | 11/2006 | Dawson |
| D543,209 S | 5/2007 | Bae |
| D573,587 S | 7/2008 | Amiya |

(Continued)

FOREIGN PATENT DOCUMENTS

| | | |
|----|---------|--------|
| GB | 2064641 | 4/1997 |
|----|---------|--------|

Primary Examiner — Daniel Bui

Assistant Examiner — Khawaja Anwar

(74) *Attorney, Agent, or Firm* — Swanson & Bratschun, L.L.C.

(73) Assignee: **Allen & Heath Limited**, Penryn, Cornwall (GB)

(**) Term: **14 Years**

(21) Appl. No.: **29/511,382**

(22) Filed: **Dec. 10, 2014**

(51) **LOC (10) Cl.** **14-03**

(52) **U.S. Cl.**
USPC **D14/217**

(58) **Field of Classification Search**
USPC D14/217, 257, 258, 434, 496, 162, 167, D14/175, 188, 196-198
CPC G06F 1/1626; G06F 1/1688; G10H 1/46; G10H 1/0008; G10H 1/0025; G10H 3/186; G10H 2210/125; G10H 2240/131; G10H 2240/175; G10H 2250/035; G10L 19/008; G10L 19/167; H03G 3/00; H03G 3/04; H03G 3/3005; H03G 3/3089; H03G 5/00; H03G 5/005; H03G 5/025; H03G 9/18; G11B 19/02; G11B 20/10527; G11B 27/00; G11B 27/34; G11B 27/031; G11B 27/034; G11B 27/038; G11B 27/105; G11B 33/025; H04H 3/186; H04H 60/04; H04H 60/05;

(57) **CLAIM**

The ornamental design for audio equipment, as shown and described.

DESCRIPTION

FIG. 1 is a front, right, top perspective view of audio equipment showing our new design;
FIG. 2 is a top plan view thereof;
FIG. 3 is a left side elevation view thereof;
FIG. 4 is a right side elevation view thereof;
FIG. 5 is a rear elevation view thereof;
FIG. 6 is a front elevation view thereof; and,
FIG. 7 is a bottom plan view thereof.
The broken lines showing portions of the design in all figures are included for the purpose of illustrating environment and unclaimed features and form no part of the claimed design.

1 Claim, 7 Drawing Sheets

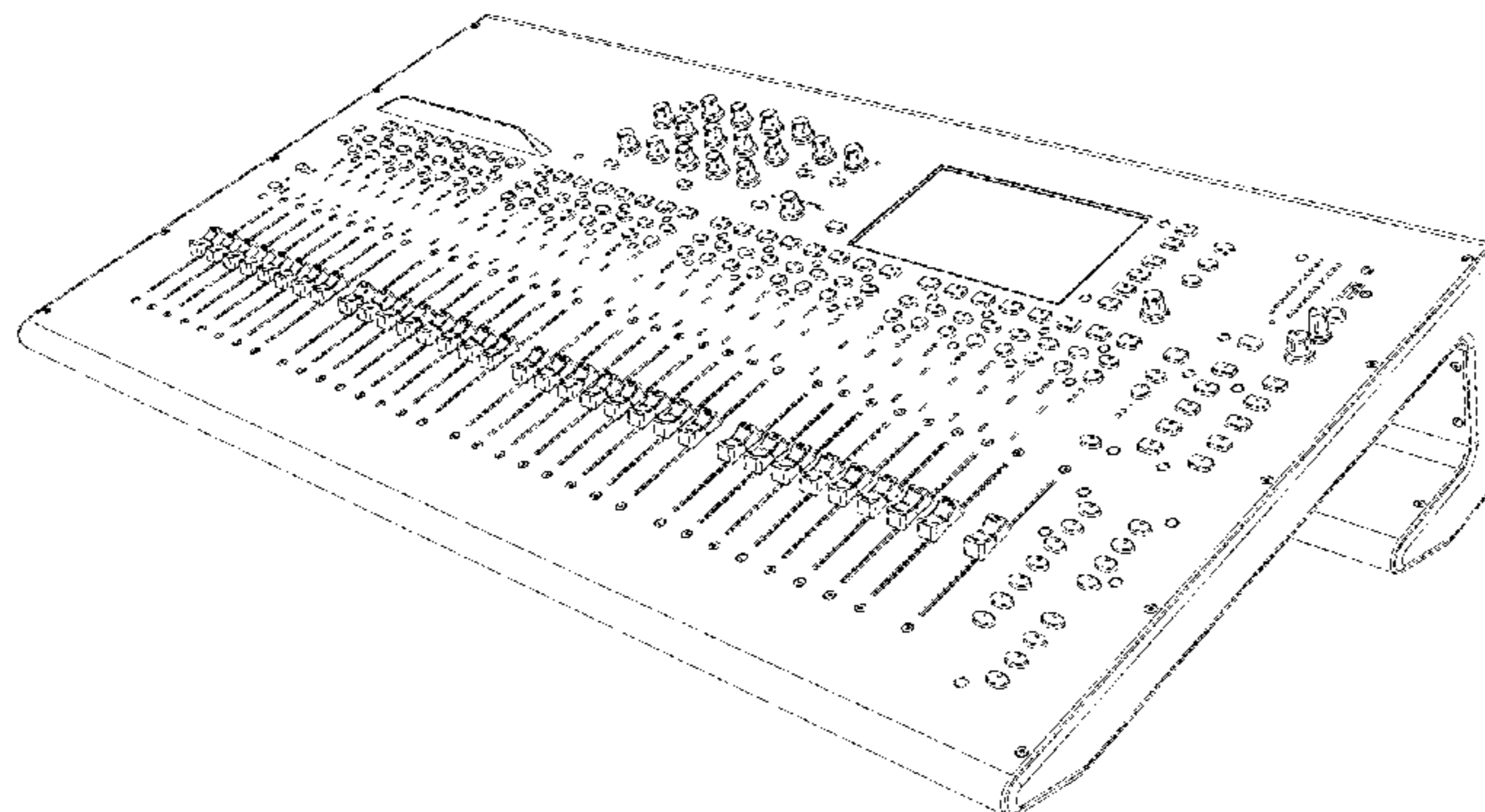

(56)

References Cited

U.S. PATENT DOCUMENTS

D603,836 S 11/2009 Hibbard
D617,767 S 6/2010 Piltonen
D643,410 S * 8/2011 Blyth et al. D14/217
D655,242 S 3/2012 Holthusen
D662,914 S 7/2012 Constin

D664,564 S 7/2012 Gillett
D690,683 S 10/2013 Olswang
D691,986 S 10/2013 Amiya
D717,278 S * 11/2014 Amiya D14/217
D721,062 S * 1/2015 Danning et al. D14/217
D721,353 S * 1/2015 Money et al. D14/217
2013/0208954 A1 8/2013 Rowe

* cited by examiner

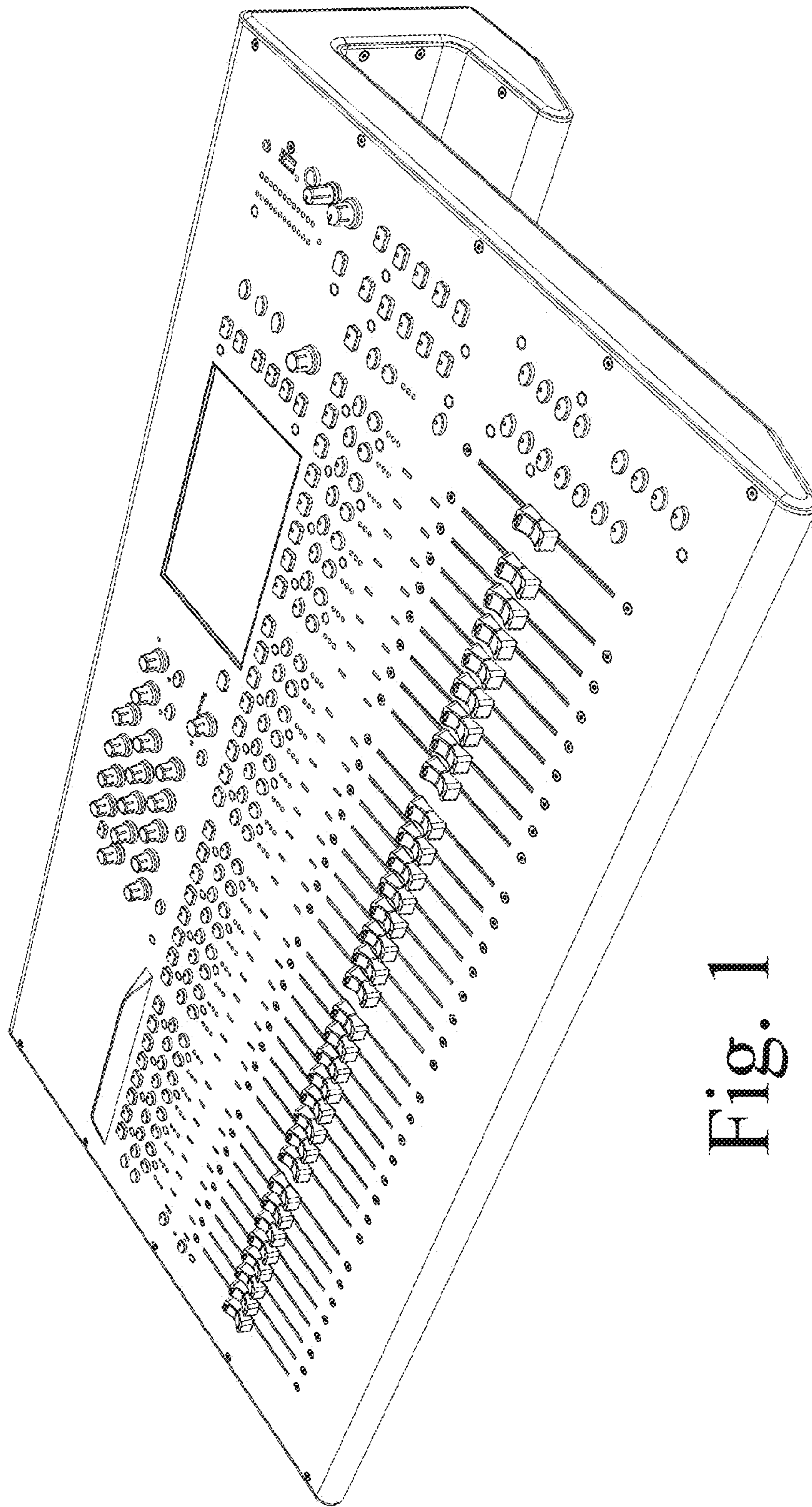

Fig. 1

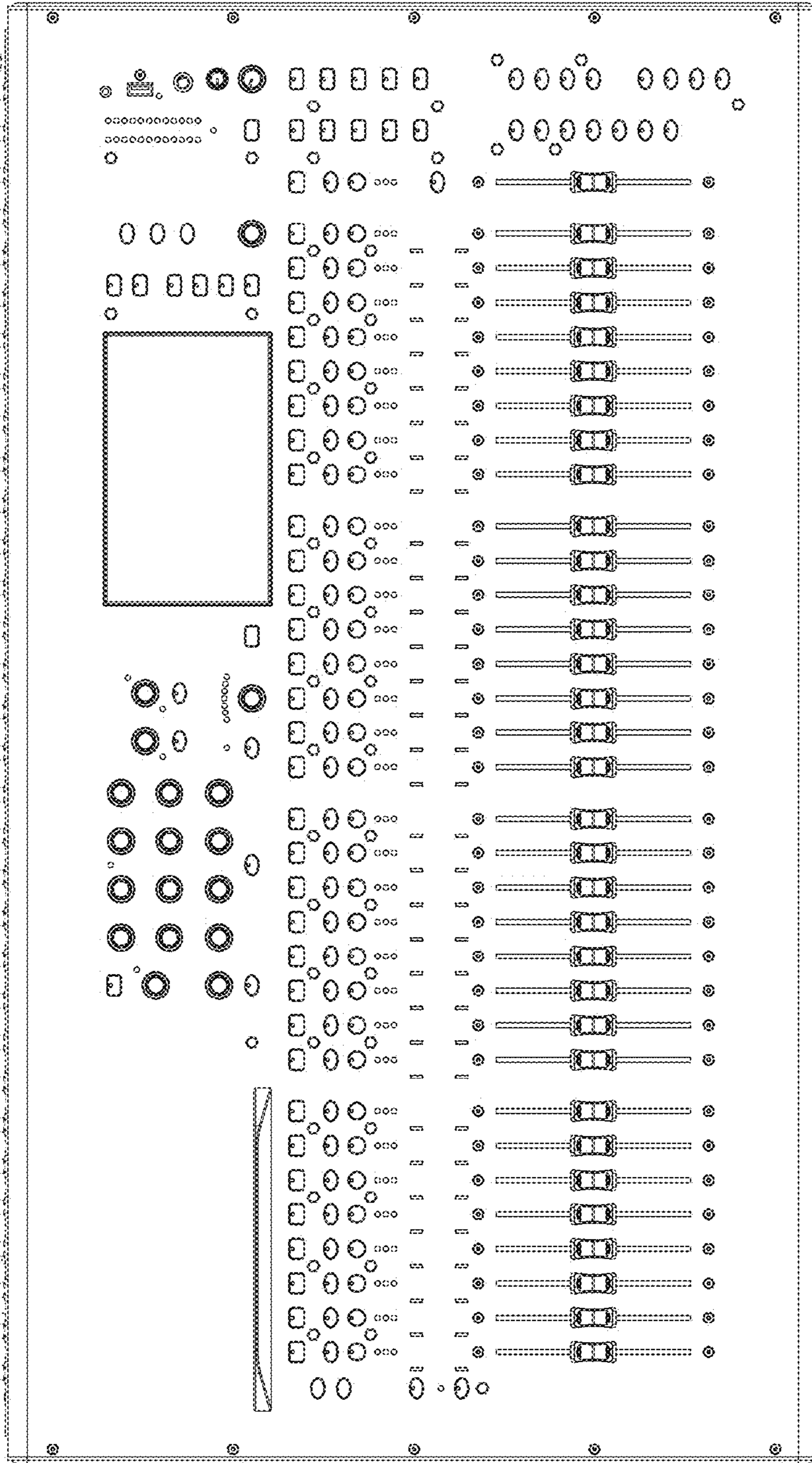

Fig. 2

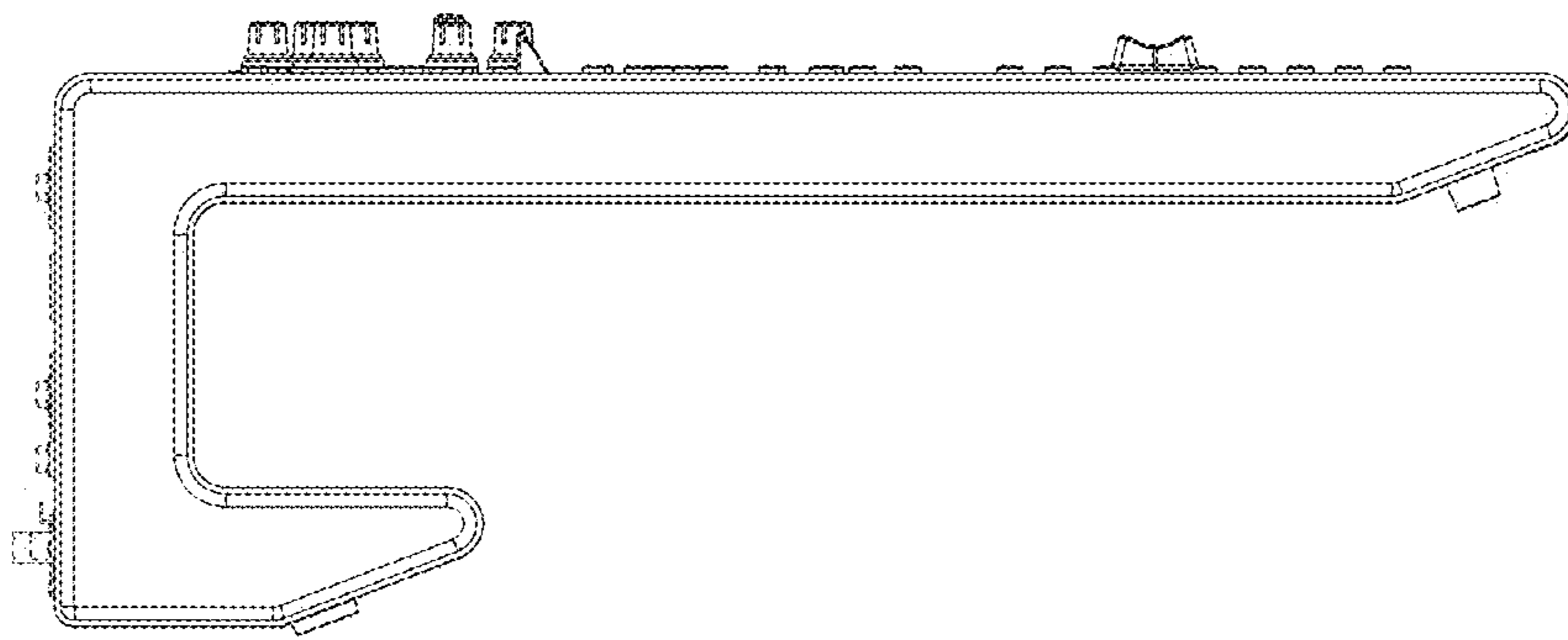

Fig. 3

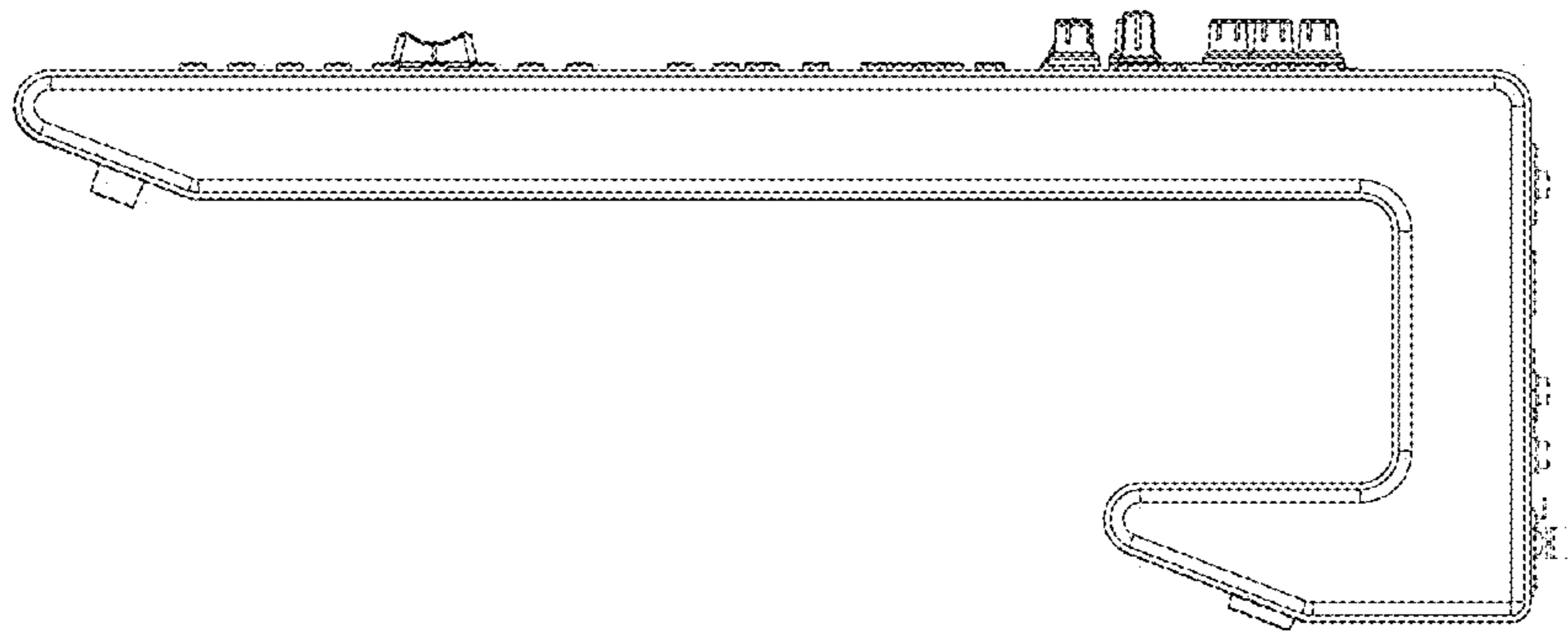

Fig. 4

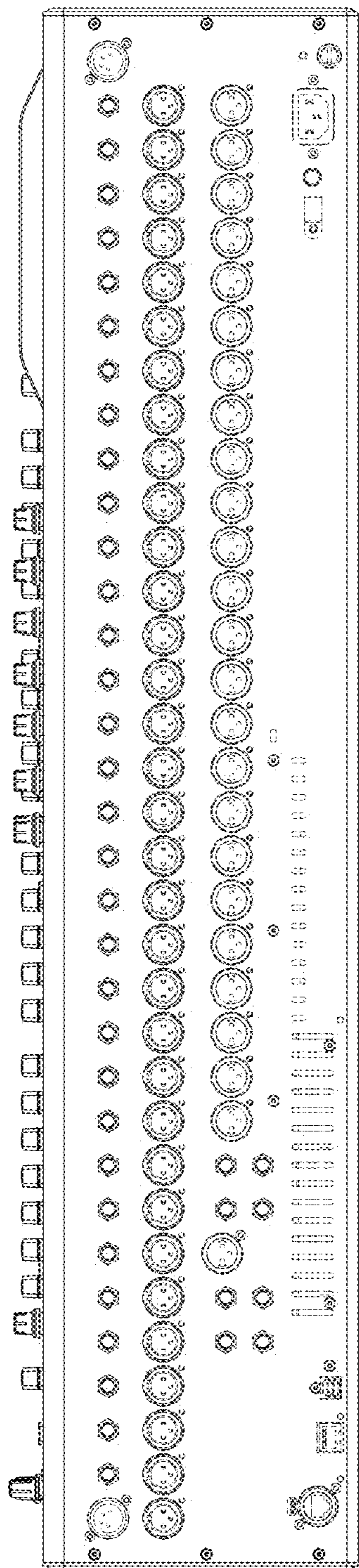

Fig. 5

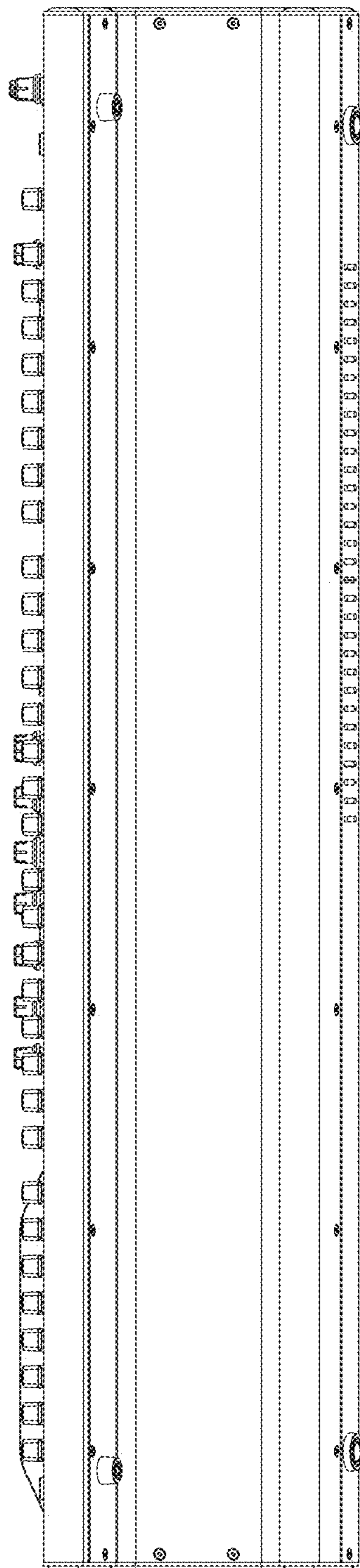

Fig. 6

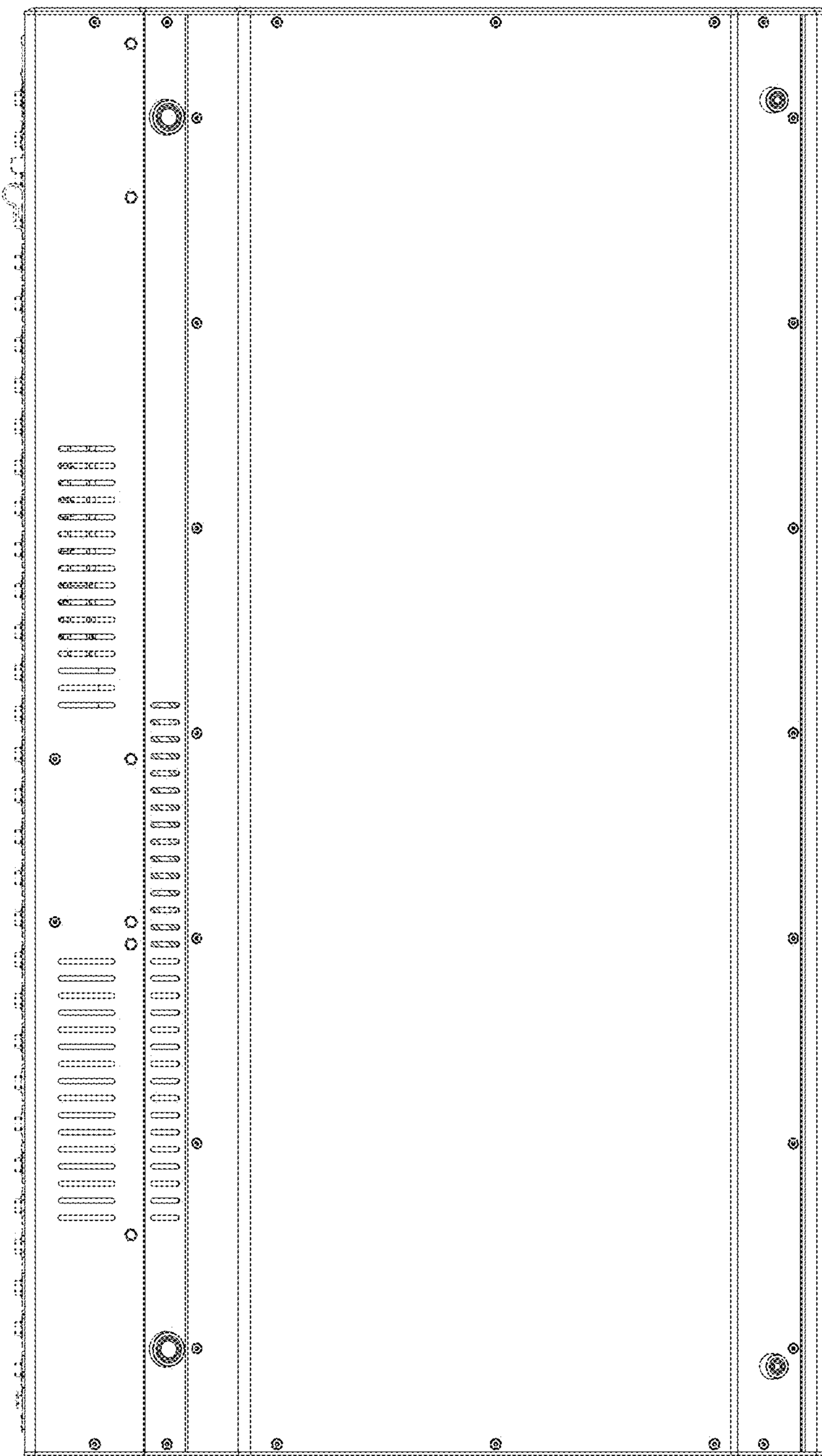

Fig. 7