



US00D744890S

(12) **United States Design Patent**
Murphy

(10) **Patent No.:** **US D744,890 S**
(45) **Date of Patent:** **** Dec. 8, 2015**

(54) **CURVED WRISTBAND WITH BUTTONS**

(71) Applicant: **Michael W. Murphy**, Bellingham, WA
(US)

(72) Inventor: **Michael W. Murphy**, Bellingham, WA
(US)

(**) Term: **14 Years**

(21) Appl. No.: **29/496,989**

(22) Filed: **Jul. 18, 2014**

(51) **LOC (10) Cl.** **11-01**

(52) **U.S. Cl.**
USPC **D11/3**

(58) **Field of Classification Search**
USPC D11/1-29; 63/1.11, 1.13-1.17, 3, 3.1,
63/3.2, 5.1, 6, 7, 12, 15, 15.1-15.3, 15.45,
63/15.5; D10/30-32; 368/281-283;
D14/344

CPC G04B 47/00; G04B 37/00; G04B 37/0058
See application file for complete search history.

(56) **References Cited**

U.S. PATENT DOCUMENTS

D113,859	S	*	3/1939	Van Cott	D11/2
3,673,795	A	*	7/1972	Nielson	D11/4
D244,671	S		6/1977	Cozza		
4,255,801	A	*	3/1981	Ode et al.	368/282
5,260,915	A	*	11/1993	Houlihan	368/282
D380,397	S		7/1997	Chan		
D383,985	S		9/1997	Davenport		
6,158,884	A	*	12/2000	Lebby et al.	368/282
D448,680	S		10/2001	Kubo		
6,442,970	B1	*	9/2002	Dangelmayer et al.	63/5.1
D466,487	S		12/2002	Wada et al.		
D565,427	S	*	4/2008	Ellner et al.	D10/31
7,441,415	B2	*	10/2008	Radley-Smith	63/3
7,450,107	B2	*	11/2008	Radley-Smith	63/1.11

D650,706	S	*	12/2011	Zanella et al.	D10/32
D664,046	S		7/2012	Claessens		
D672,255	S	*	12/2012	Zanella et al.	D10/32
D703,069	S	*	4/2014	Adams et al.	D10/31
D714,178	S	*	9/2014	Sabbioni	D11/3

* cited by examiner

Primary Examiner — Garth Rademaker

Assistant Examiner — Llorellys Martinez-Rivera

(74) *Attorney, Agent, or Firm* — Seed IP Law Group PLLC

(57) **CLAIM**

The ornamental design for a curved wristband with buttons, as shown and described.

DESCRIPTION

FIG. 1 is a top perspective view of a curved wristband with buttons showing a first embodiment of my new design.

FIG. 2 is a top plan view thereof.

FIG. 3 is a bottom plan view thereof.

FIG. 4 is a left side view of thereof.

FIG. 5 is a right side view of thereof.

FIG. 6 is a front elevation view thereof.

FIG. 7 is a back elevation view thereof.

FIG. 8 is a top perspective view of a curved wristband with buttons showing a second embodiment of my new design.

FIG. 9 is a top plan view thereof.

FIG. 10 is a bottom plan view thereof.

FIG. 11 is a left side view of thereof.

FIG. 12 is a right side view of thereof.

FIG. 13 is a front elevation view thereof; and,

FIG. 14 is a back elevation view thereof.

The broken lines in the drawings illustrate portions of the curved wristband with buttons that form no part of the claimed design.

1 Claim, 12 Drawing Sheets

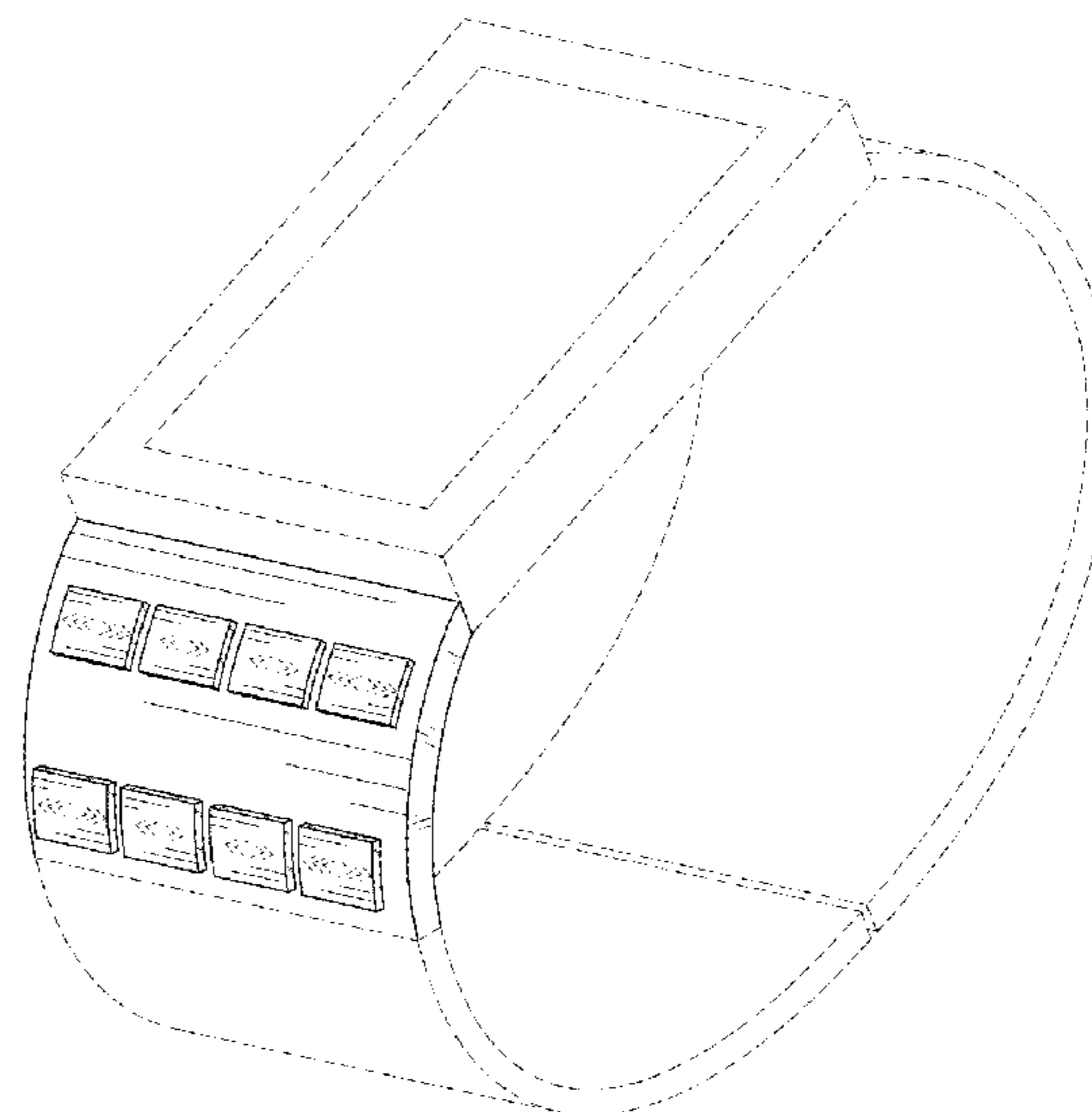
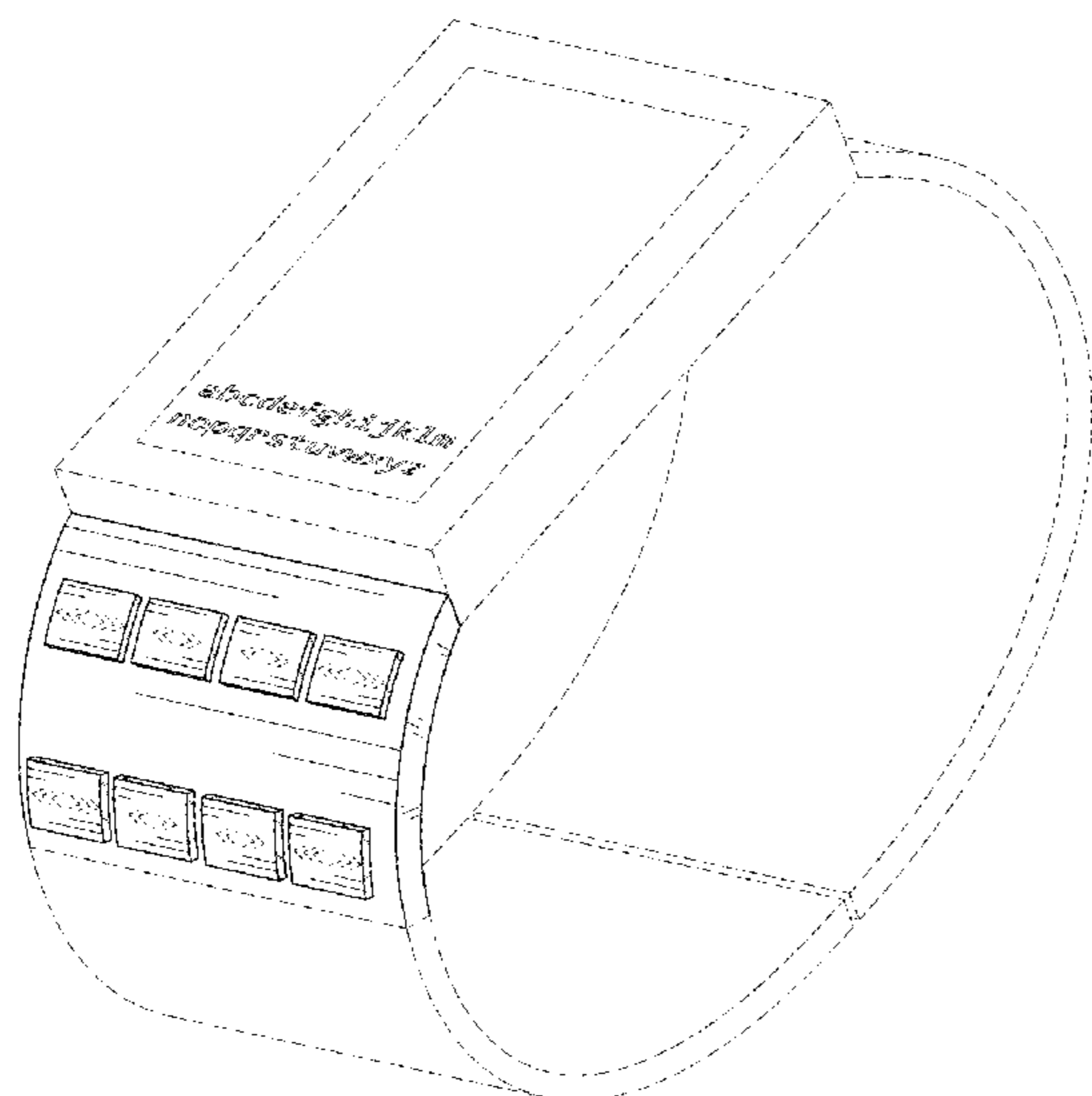

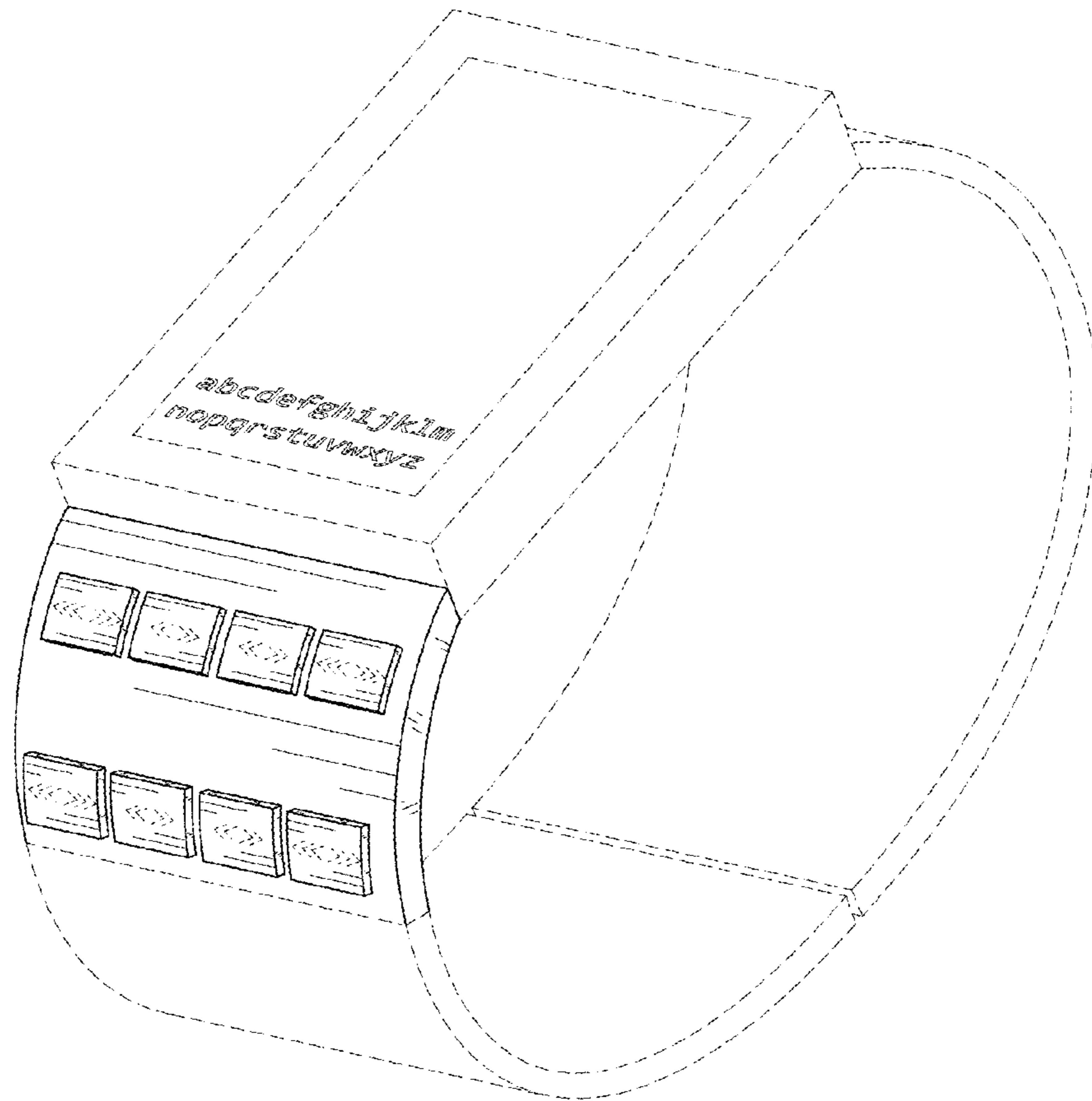

FIG. 1

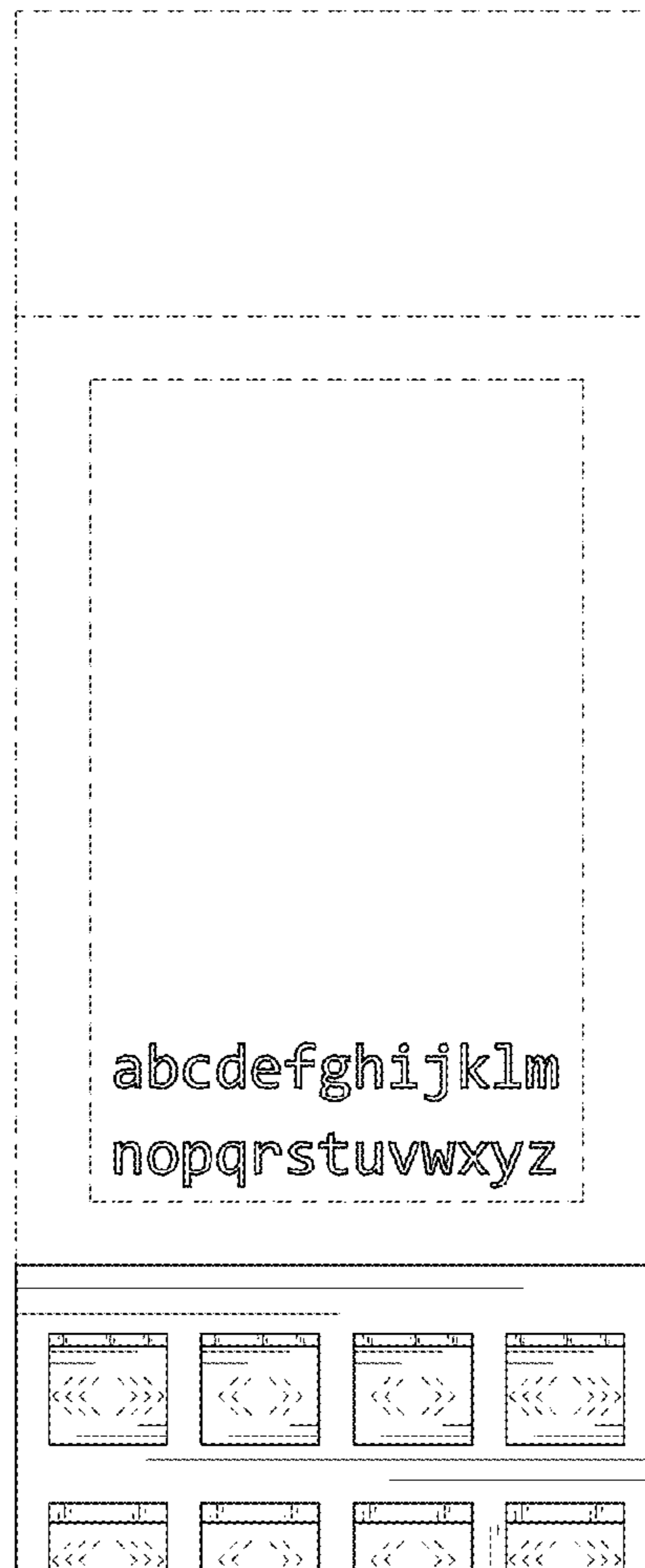

FIG. 2

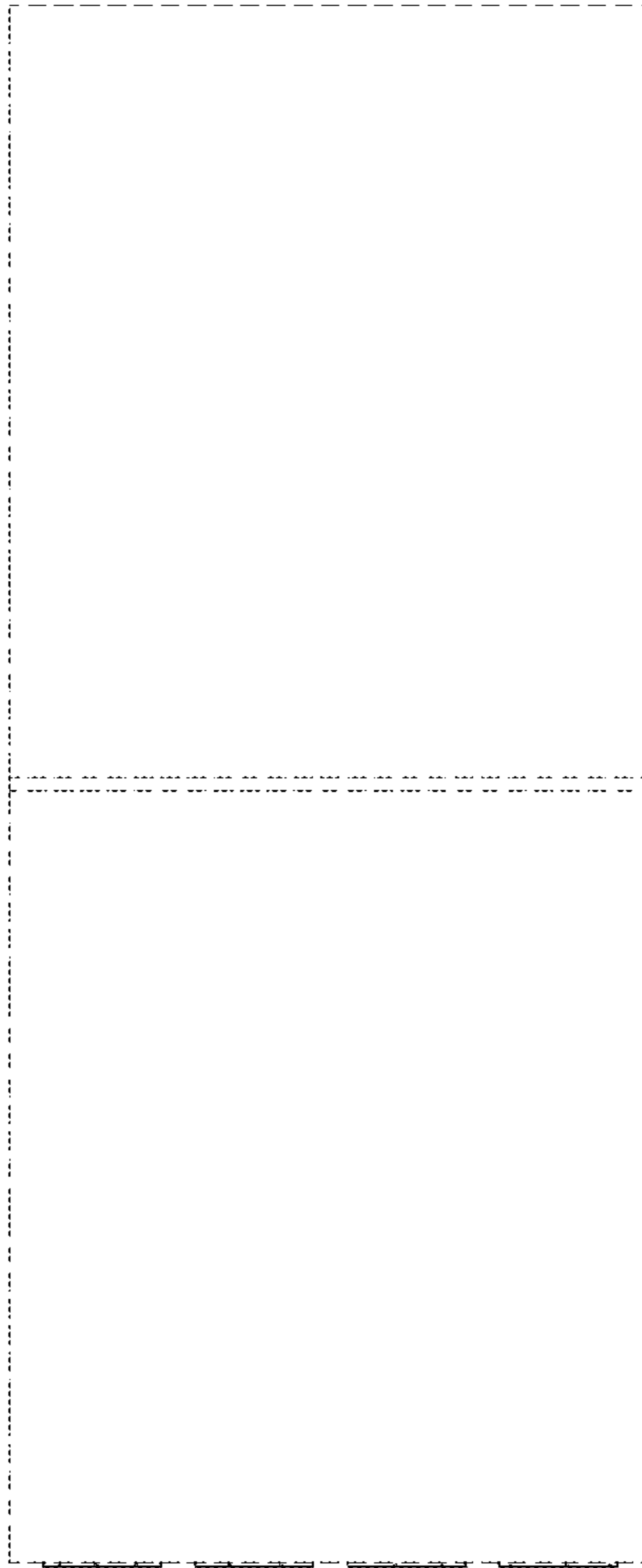

FIG. 3

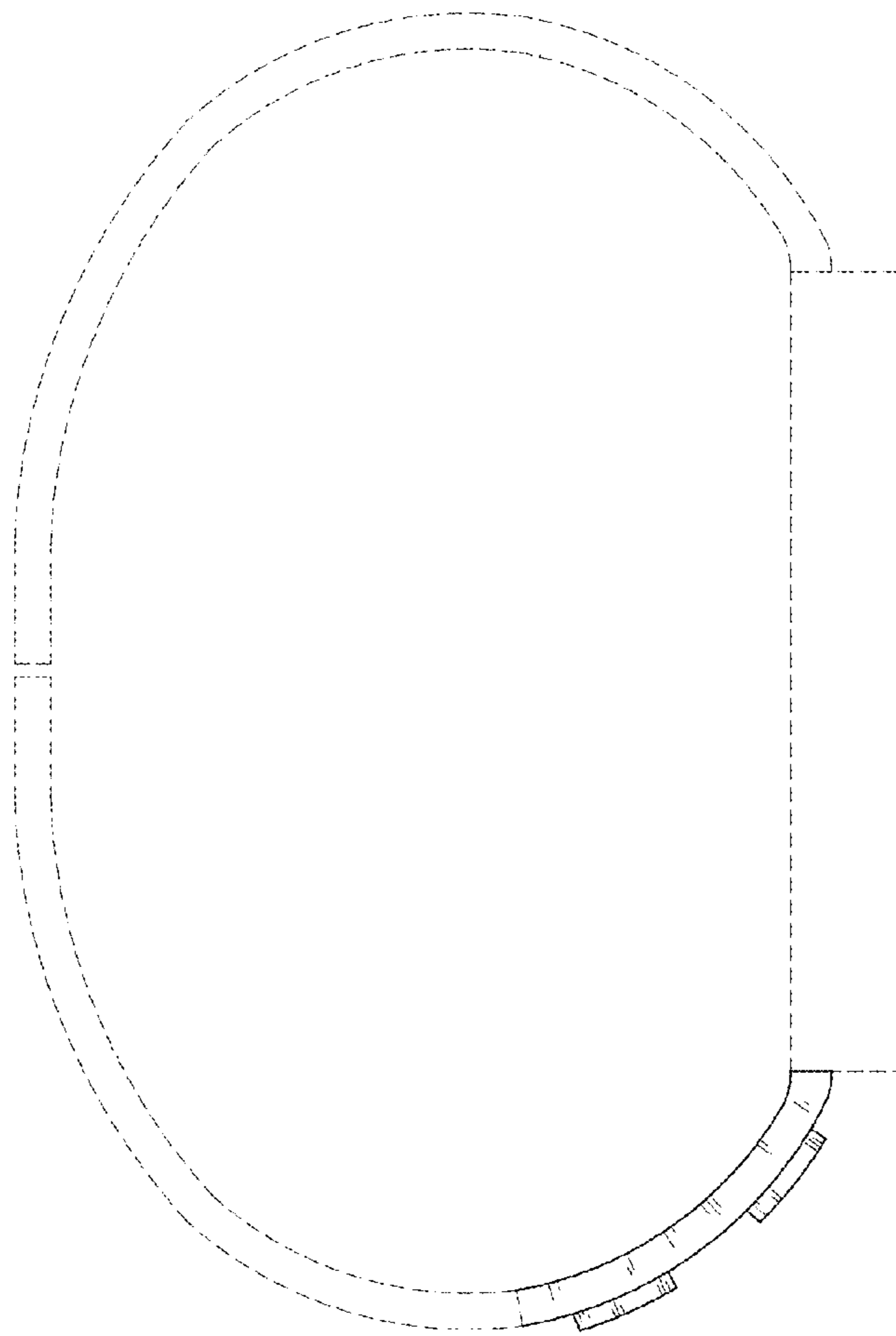

FIG. 4

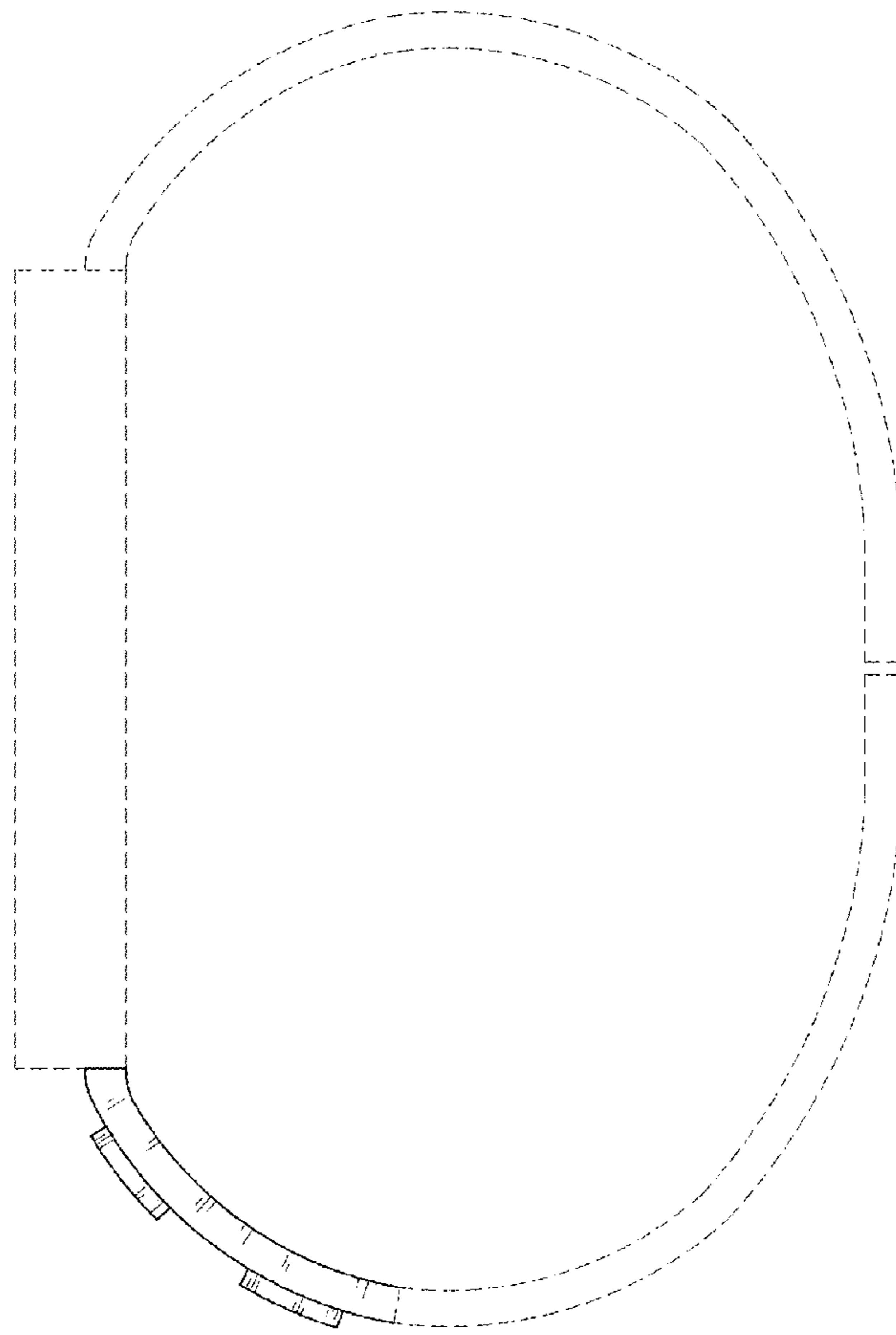

FIG. 5

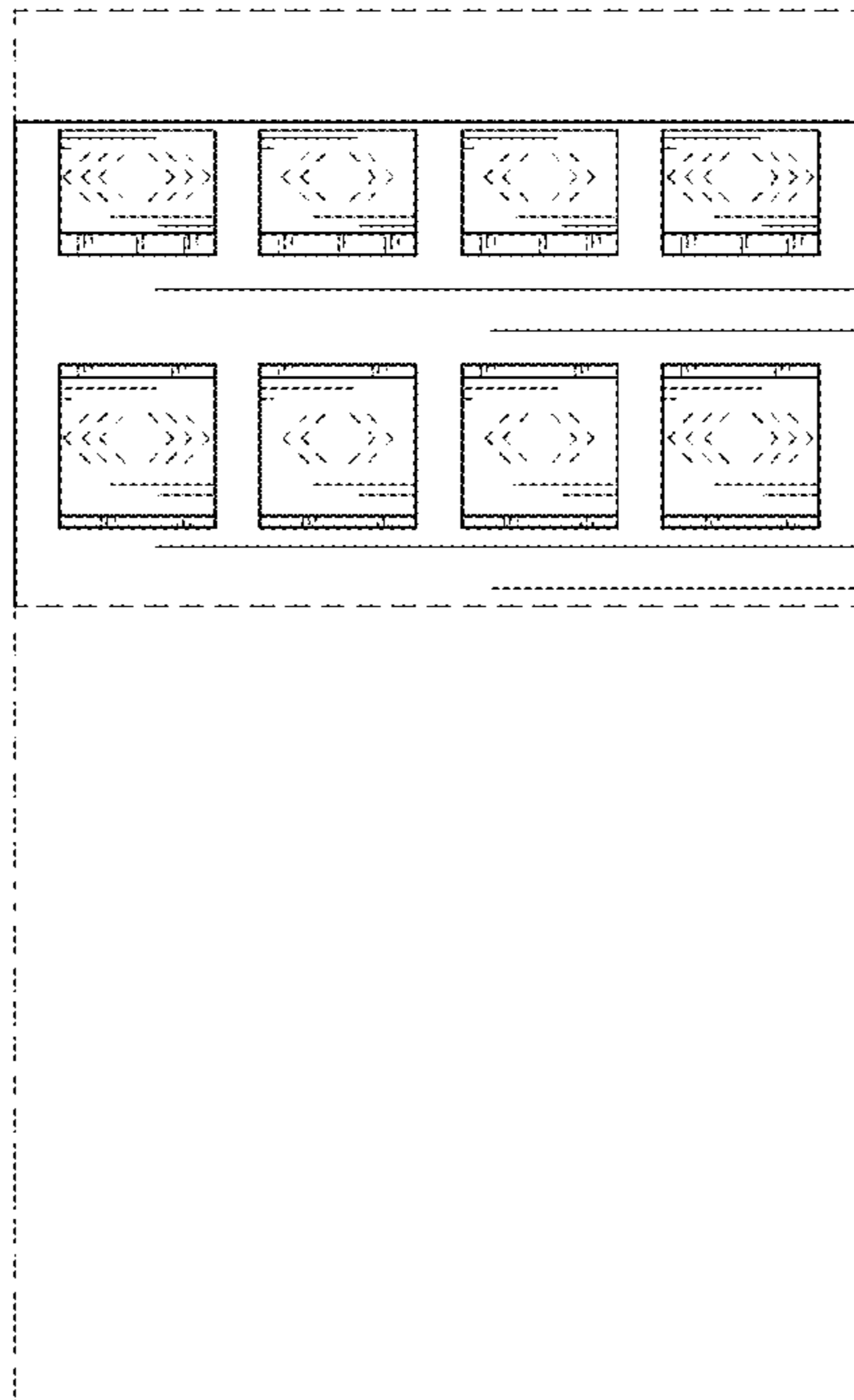

FIG. 6

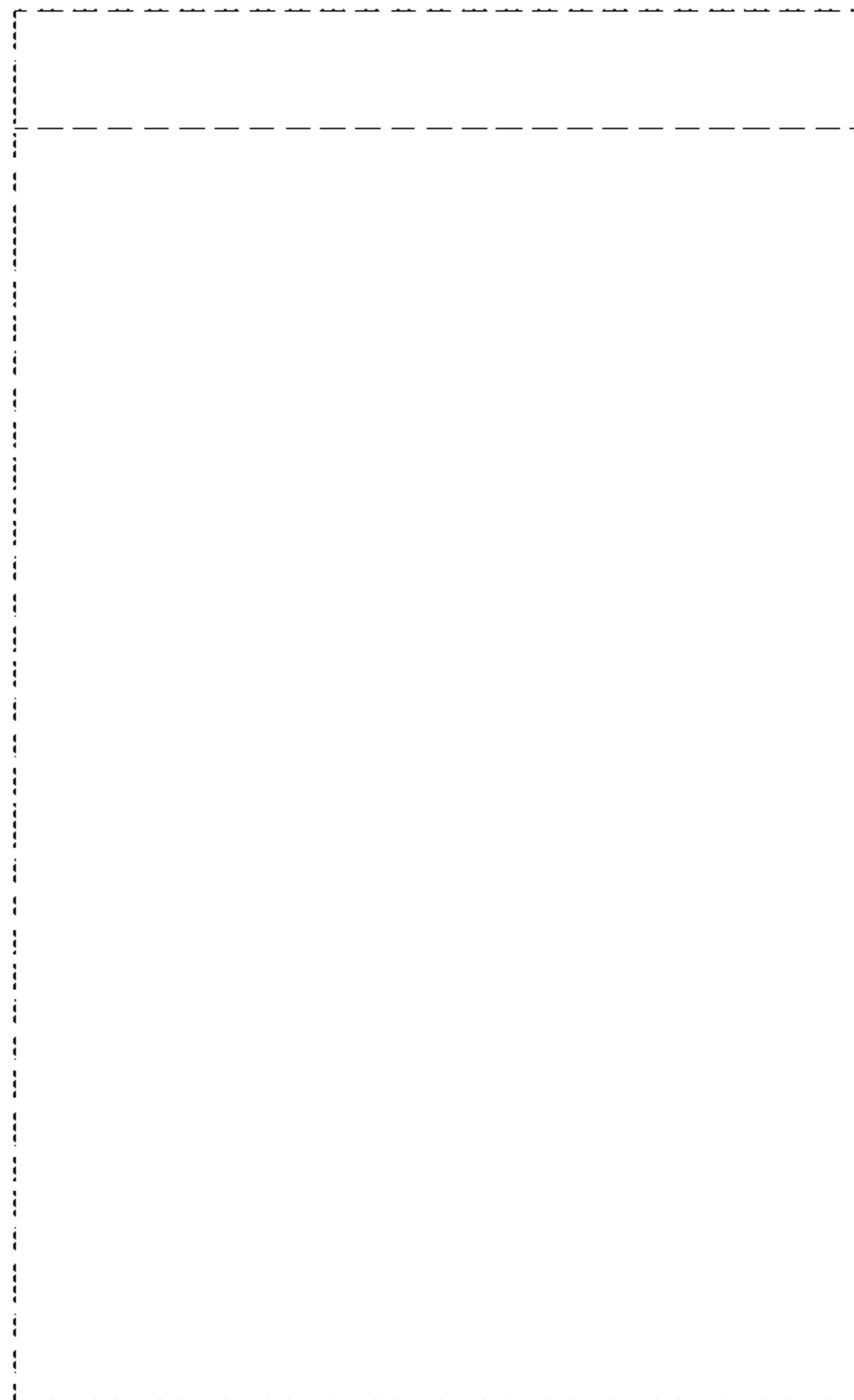

FIG. 7

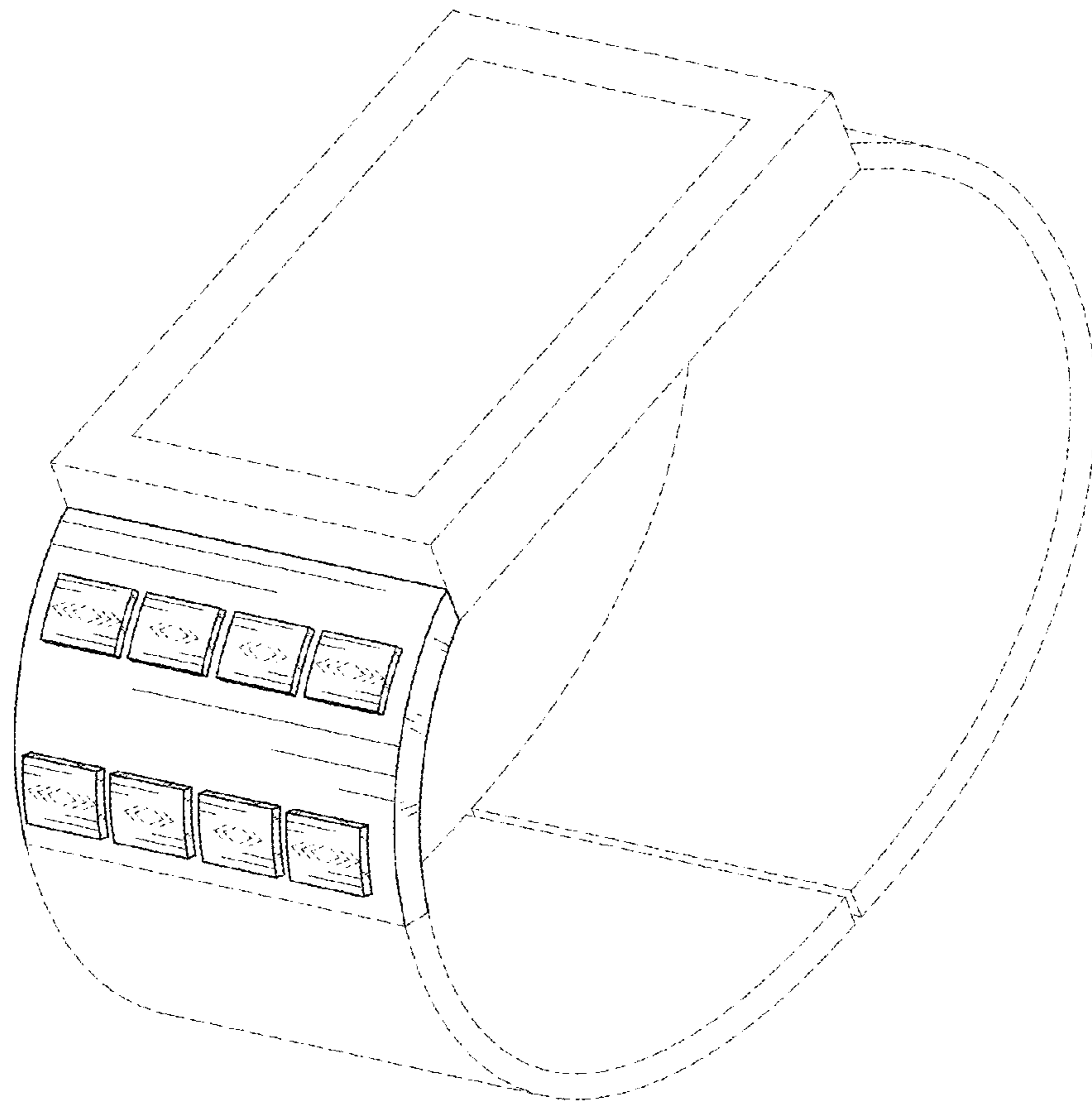

FIG. 8



FIG. 9

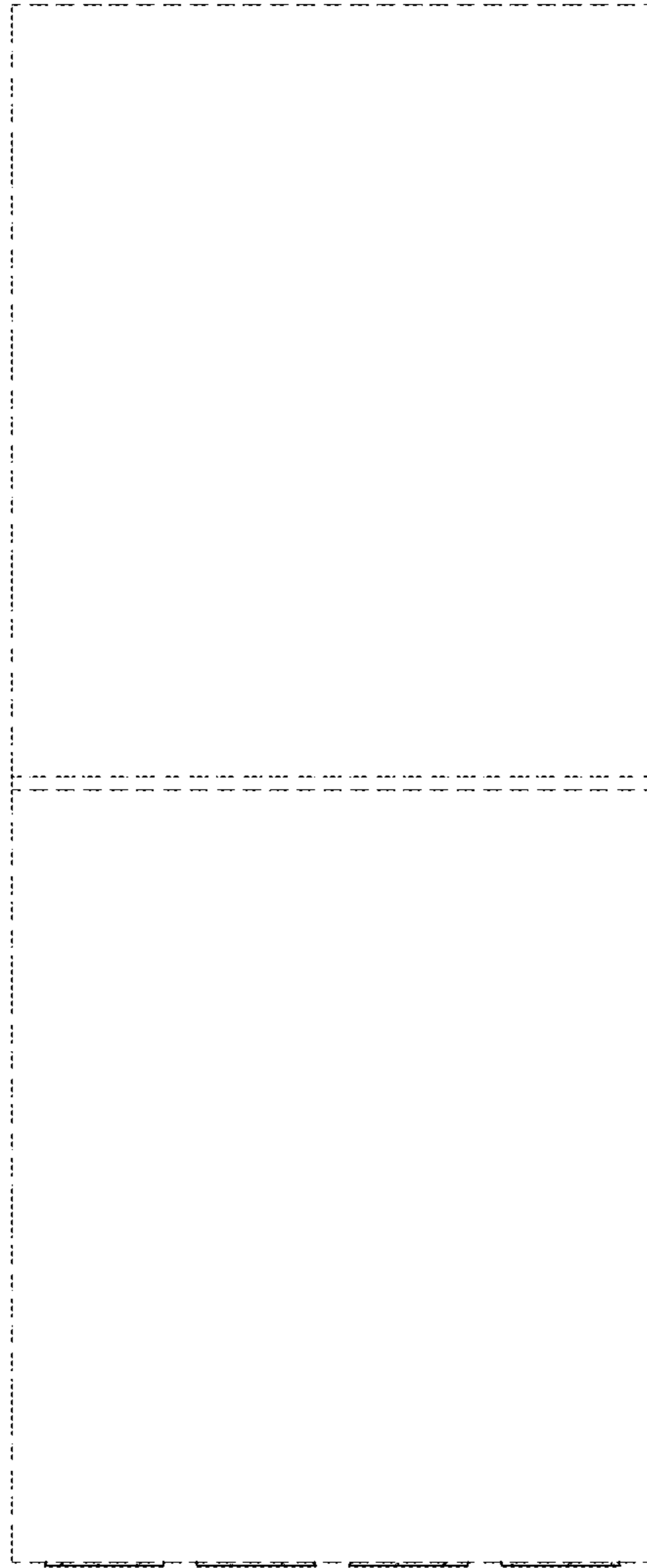

FIG. 10

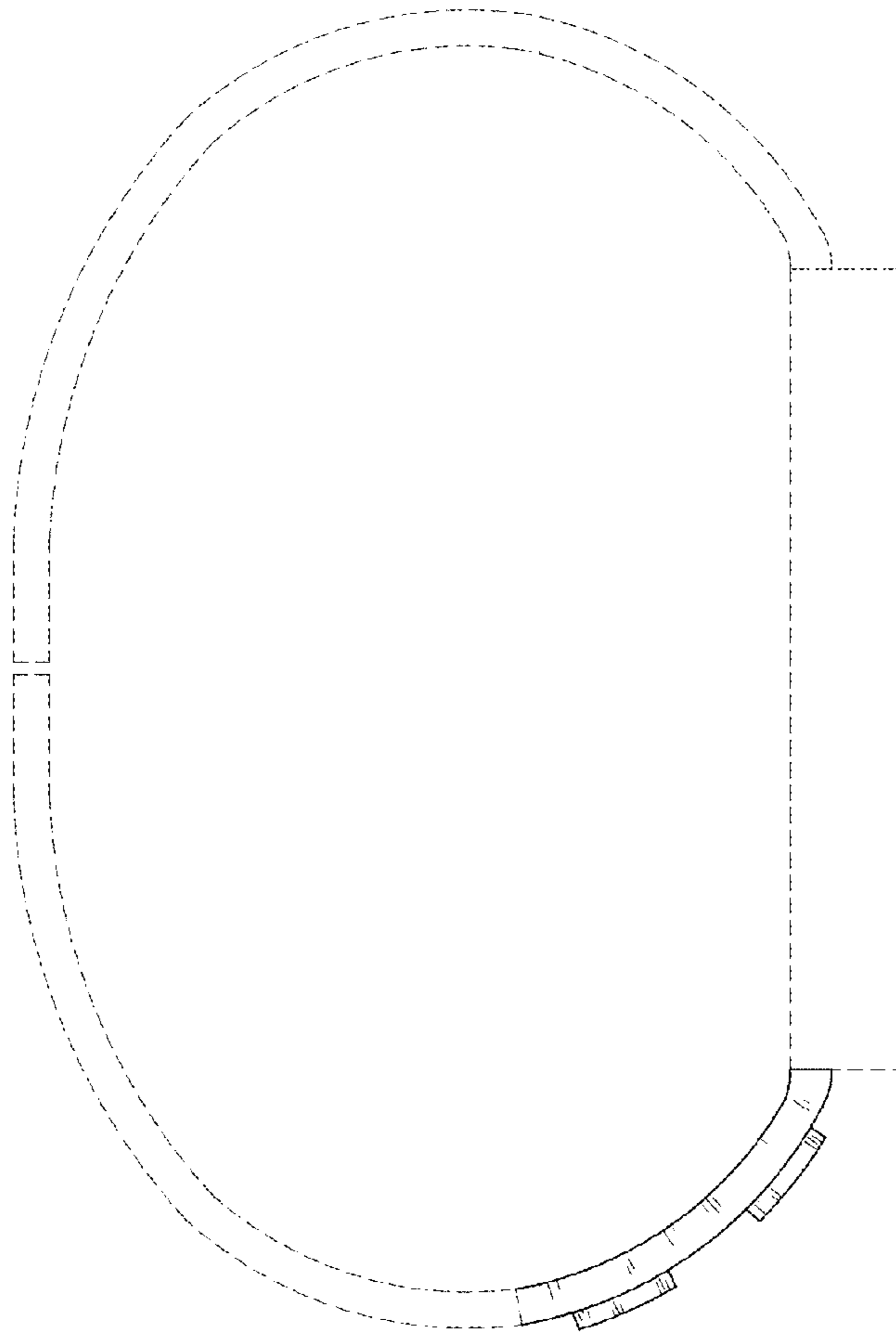

FIG. 11

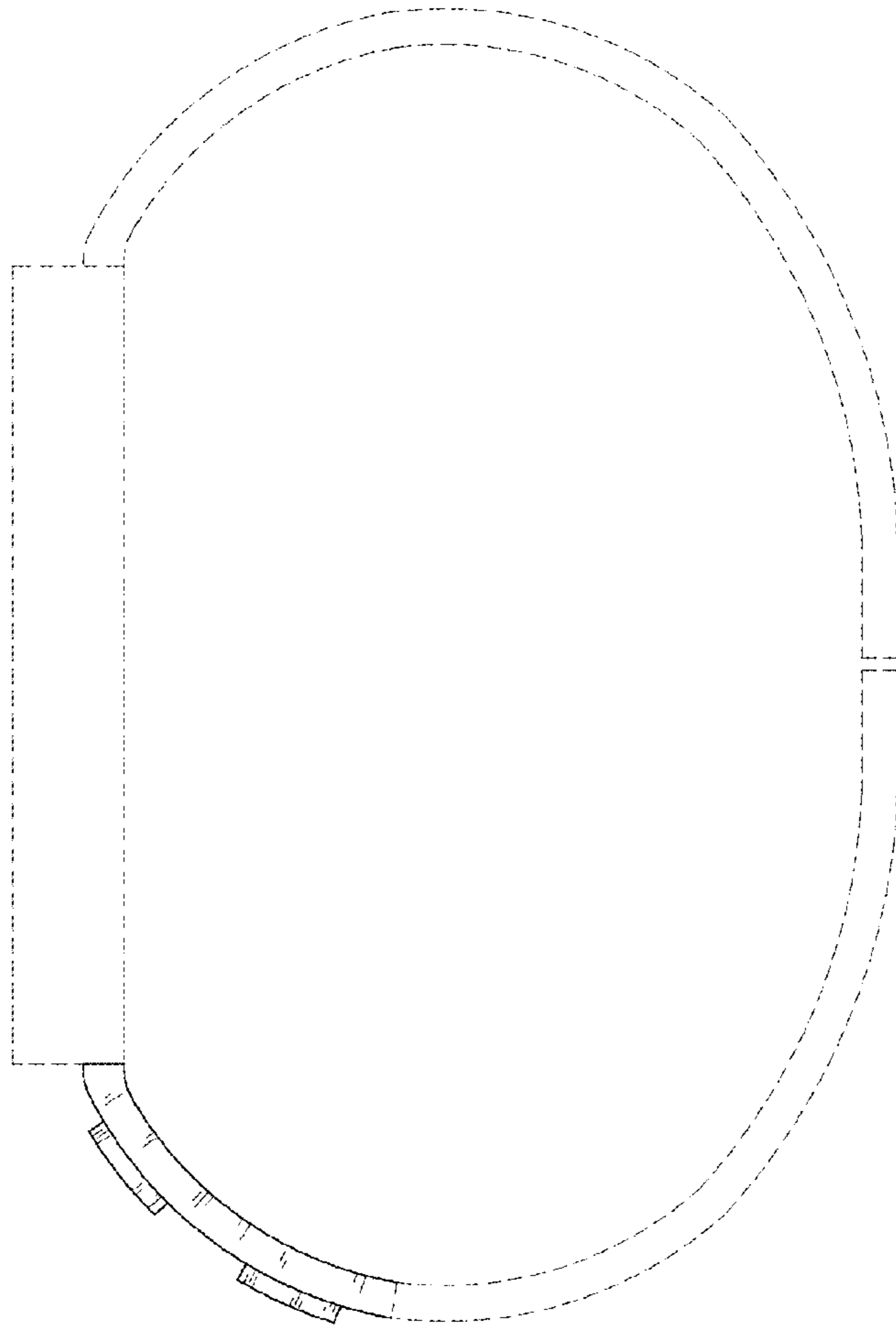

FIG. 12

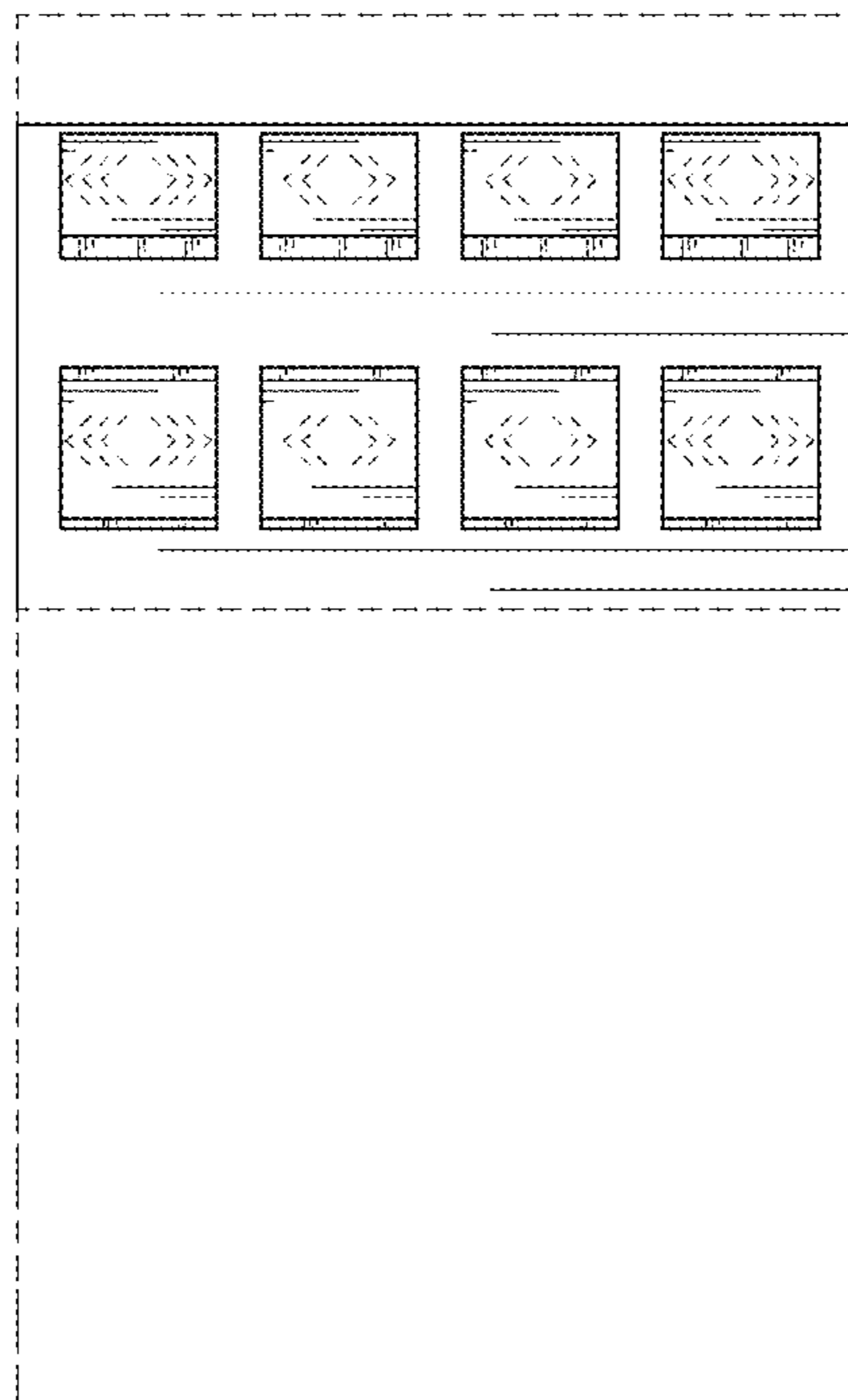

FIG. 13

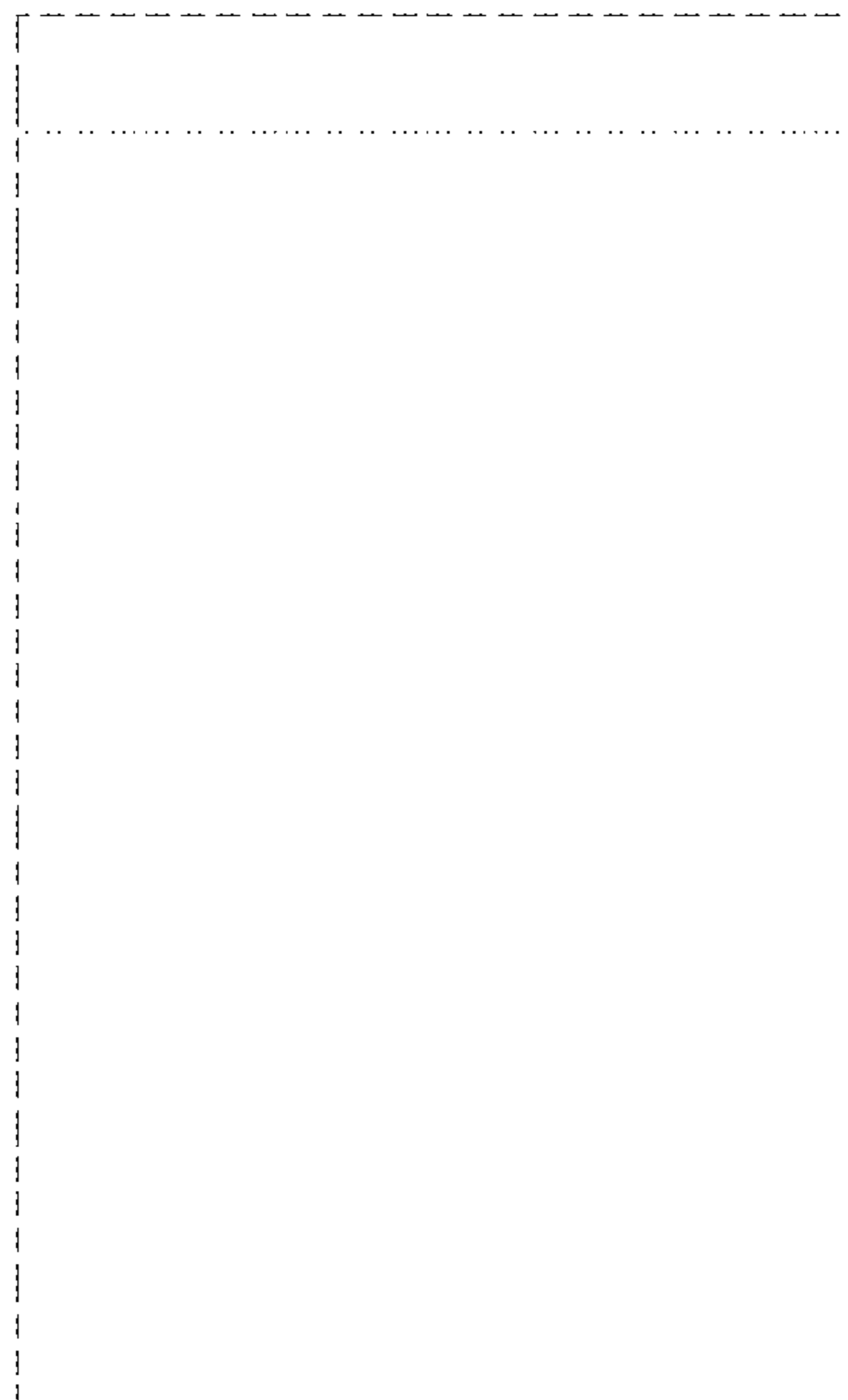

FIG. 14