



US00D744774S

(12) **United States Design Patent**
Bock et al.

(10) **Patent No.:** **US D744,774 S**
(45) **Date of Patent:** **** Dec. 8, 2015**

- (54) **BEVERAGE MAKER**
- (71) Applicant: **Hamilton Beach Brands, Inc.**, Glen Allen, VA (US)
- (72) Inventors: **Brian Bock**, Midlothian, VA (US);
Patrick T Mulvaney, Richmond, VA (US)
- (73) Assignee: **Hamilton Beach Brands, Inc.**, Glen Allen, VA (US)
- (**) Term: **14 Years**
- (21) Appl. No.: **29/484,936**
- (22) Filed: **Mar. 14, 2014**

D514,867 S *	2/2006	Steiner	D7/309
7,047,870 B2 *	5/2006	Gantt et al.	99/305
7,059,239 B2	6/2006	Balkau	
D546,112 S *	7/2007	Rorke et al.	D7/309
D558,506 S *	1/2008	Garman	D7/309
D559,611 S *	1/2008	Cheong	D7/306
D570,149 S *	6/2008	Truong	D7/309
D571,598 S *	6/2008	Moore	D7/306
7,677,157 B2	3/2010	Steiner et al.	
D620,302 S *	7/2010	Picozza et al.	D7/309
D622,536 S *	8/2010	Ågren et al.	D7/309
D623,461 S *	9/2010	Ashbridge	D7/306
7,997,187 B2 *	8/2011	Garman et al.	99/304
2008/0115674 A1	5/2008	Huang et al.	
2013/0095212 A1	4/2013	Beer	
2013/0236618 A1	9/2013	Tinkler et al.	

* cited by examiner

Primary Examiner — Marianne Pandozzi
(74) *Attorney, Agent, or Firm* — Alexander D. Raring

Related U.S. Application Data

- (63) Continuation of application No. 13/754,158, filed on Jan. 30, 2013.
- (51) **LOC (10) Cl.** **07-01**
- (52) **U.S. Cl.**
USPC **D7/306; D7/311**
- (58) **Field of Classification Search**
USPC D7/306–311, 305, 300, 313; 99/279,
99/284, 290, 280, 299, 307, 323.1;
222/23, 129.1; 62/395; D20/1
CPC A47J 31/44; A47J 31/00; B67D 1/0041;
B67D 3/00
See application file for complete search history.

(57) **CLAIM**
The ornamental design for a beverage maker, as shown and described.

DESCRIPTION

FIG. 1 a front perspective view of a beverage maker showing our new design;
FIG. 2 is a front elevation view thereof;
FIG. 3 is a left side elevation view thereof;
FIG. 4 is a right side elevation view thereof;
FIG. 5 is a rear elevation view thereof;
FIG. 6 is a top plan view thereof;
FIG. 7 is a bottom plan view thereof; and,
FIG. 8 is a rear perspective view thereof.
The broken lines in the figures are for the purpose of showing environmental structure and form no part of the claimed design.

- (56) **References Cited**
U.S. PATENT DOCUMENTS
D343,757 S * 2/1994 Bannigan D7/309
6,606,938 B2 8/2003 Taylor
6,708,600 B2 3/2004 Winkler et al.
D514,865 S * 2/2006 Steiner D7/309

1 Claim, 8 Drawing Sheets

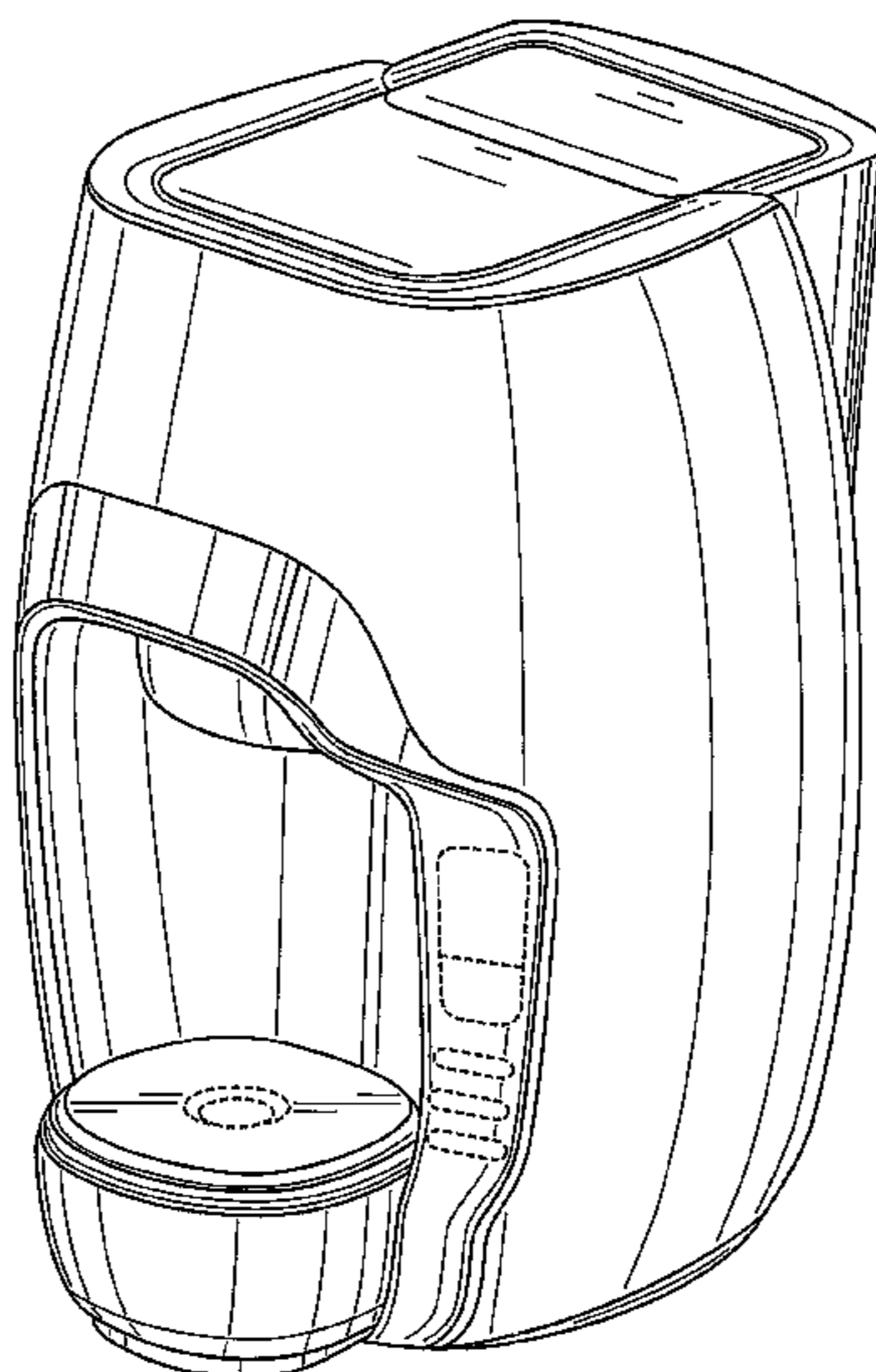

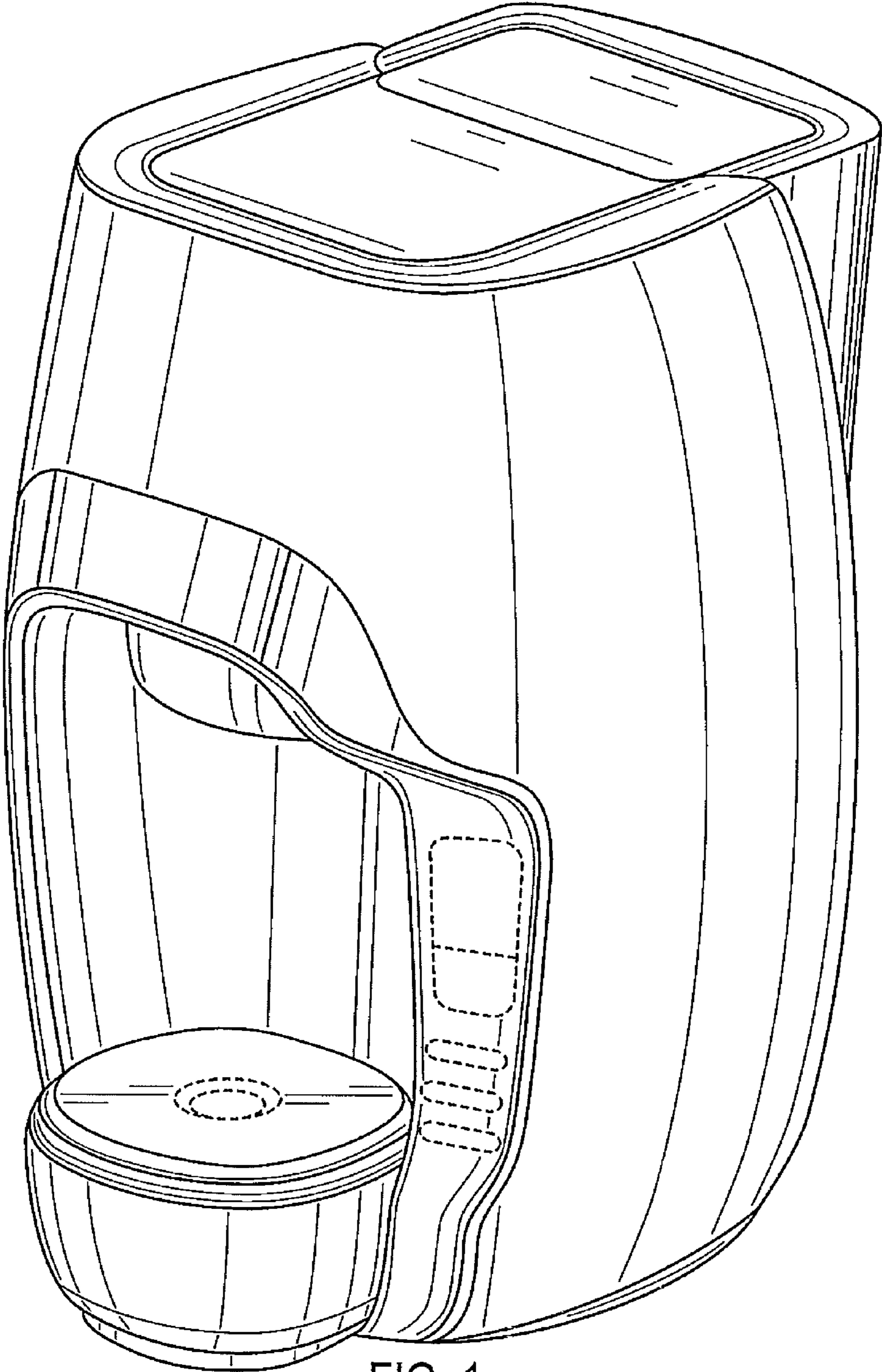

FIG. 1

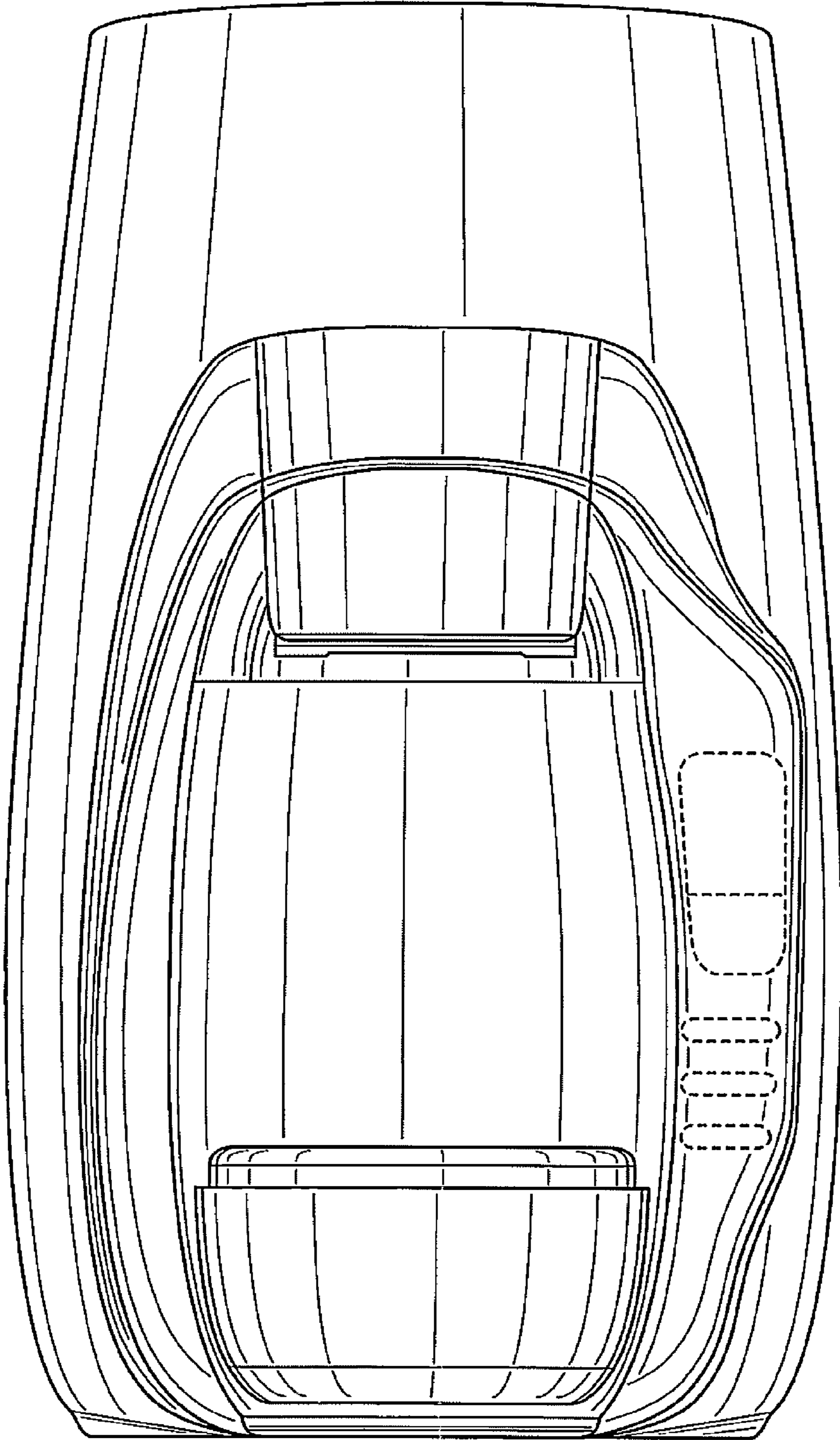

FIG. 2

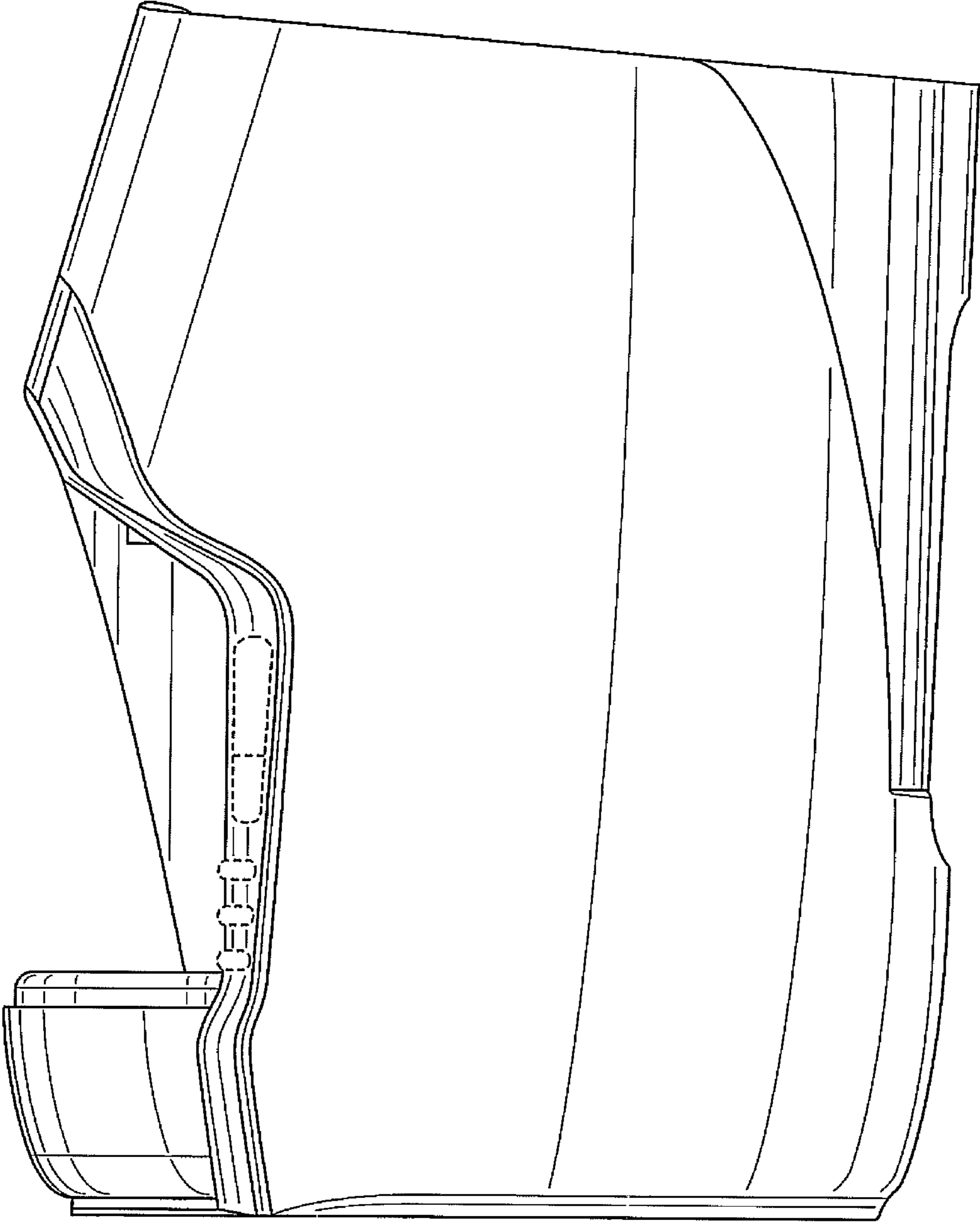

FIG. 3

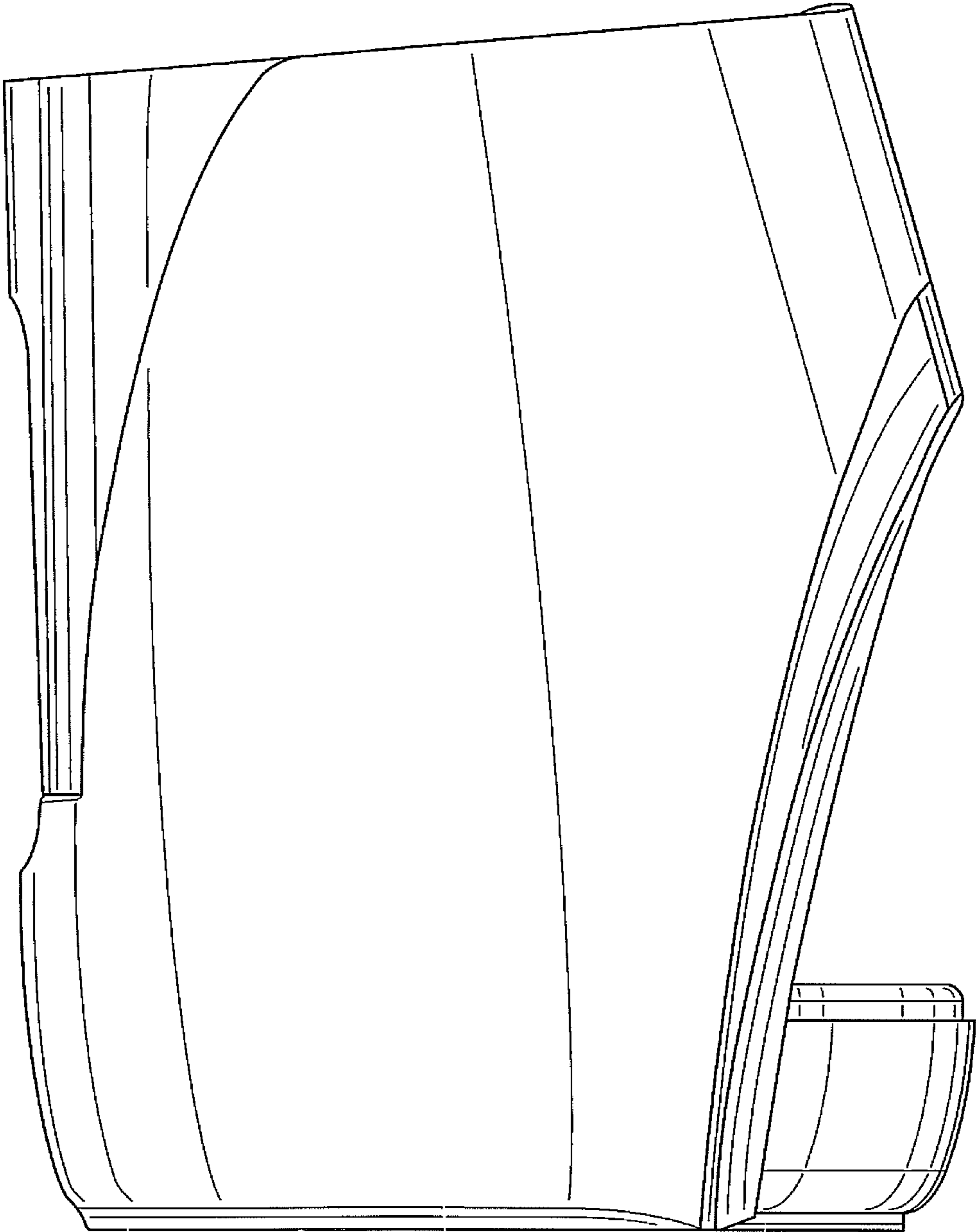

FIG. 4

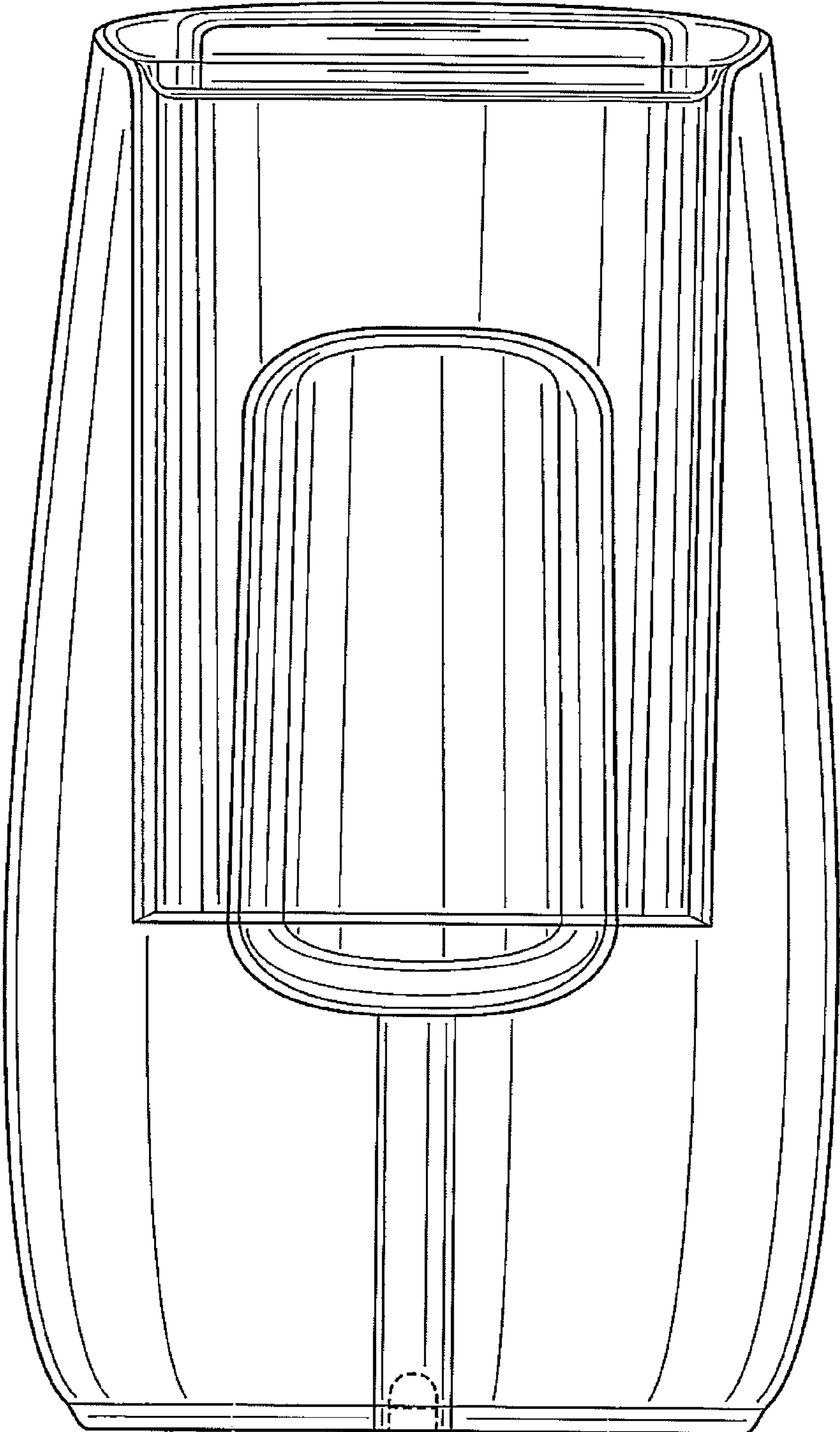

FIG. 5

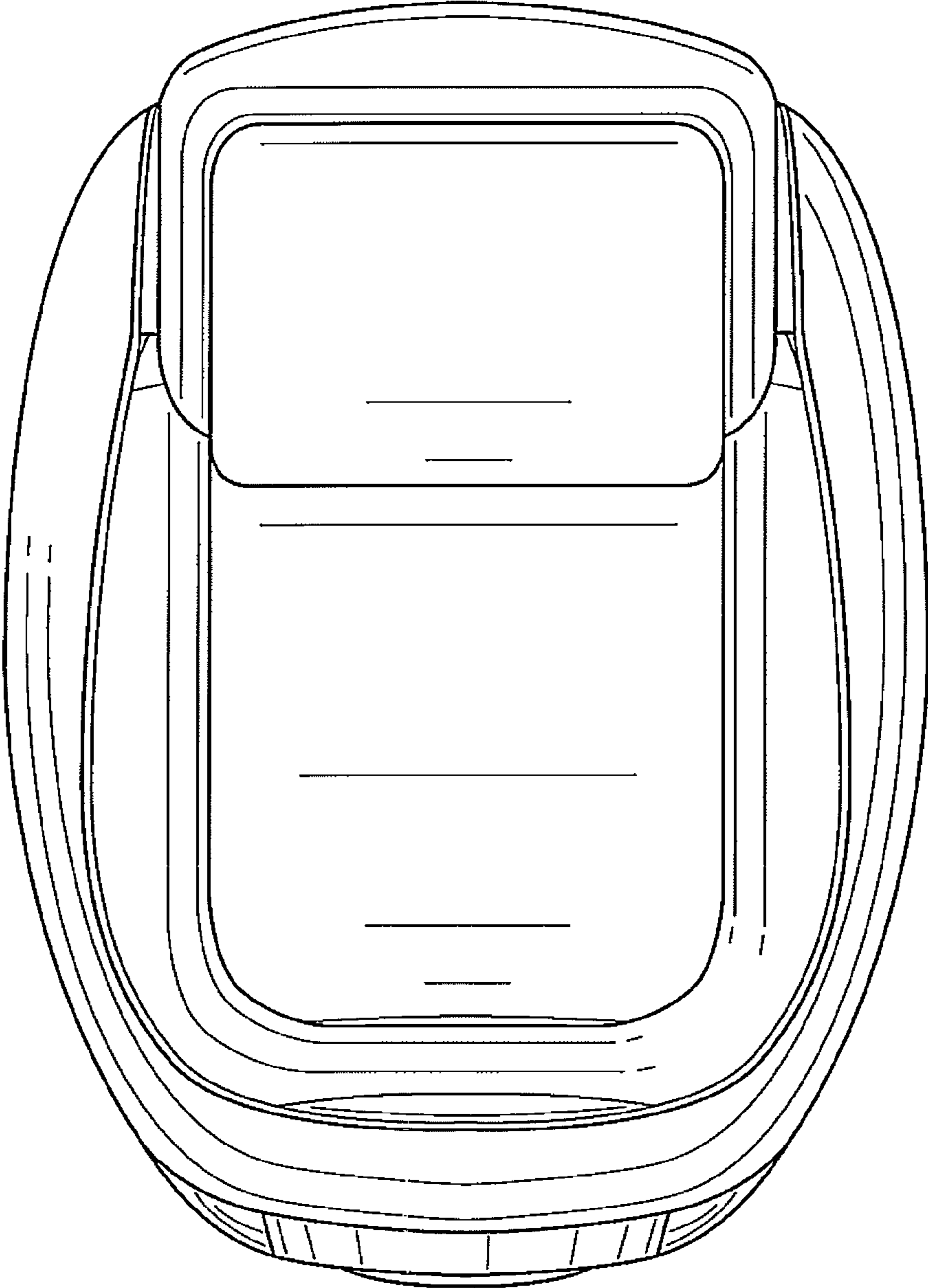

FIG. 6

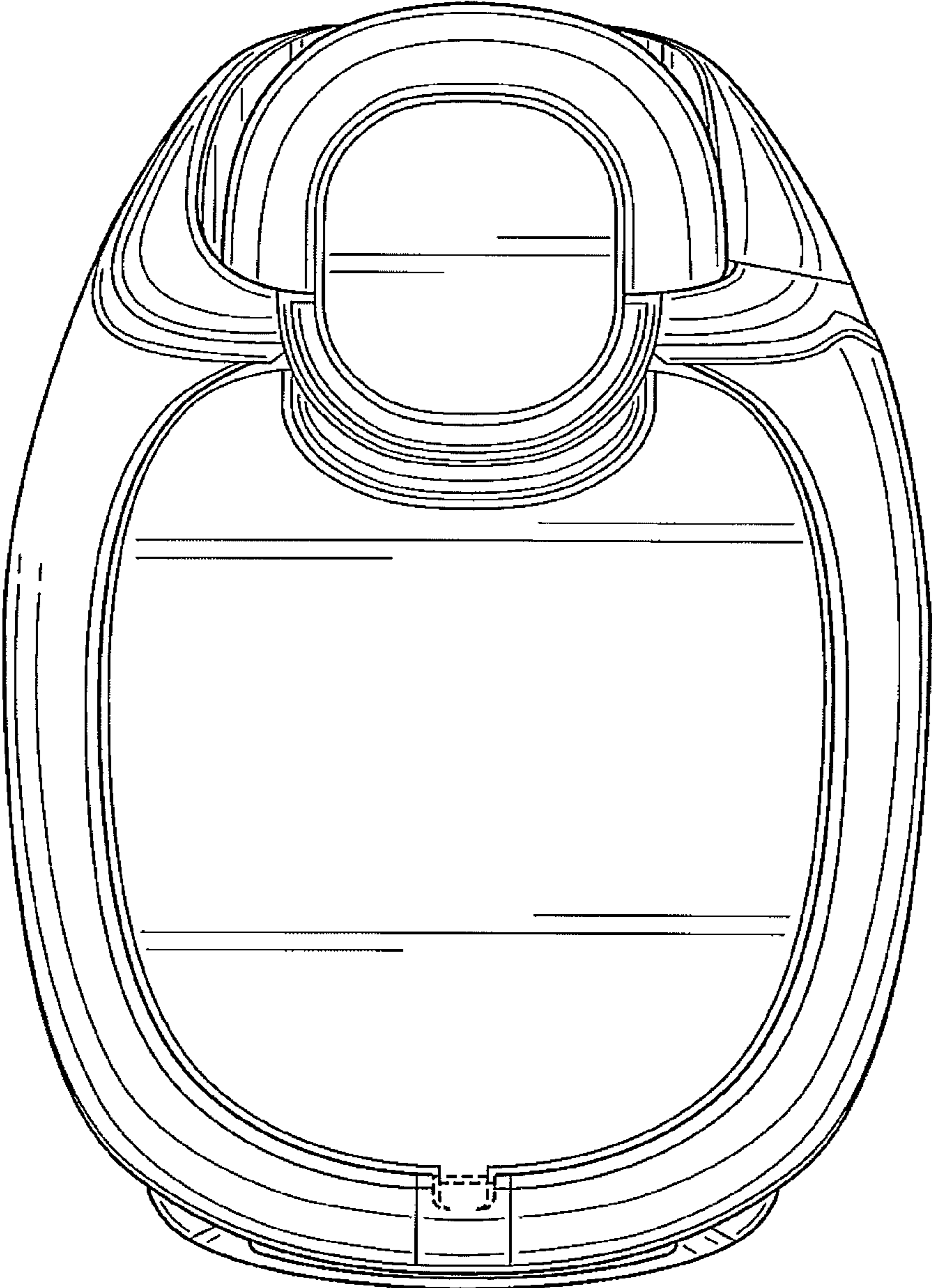

FIG. 7

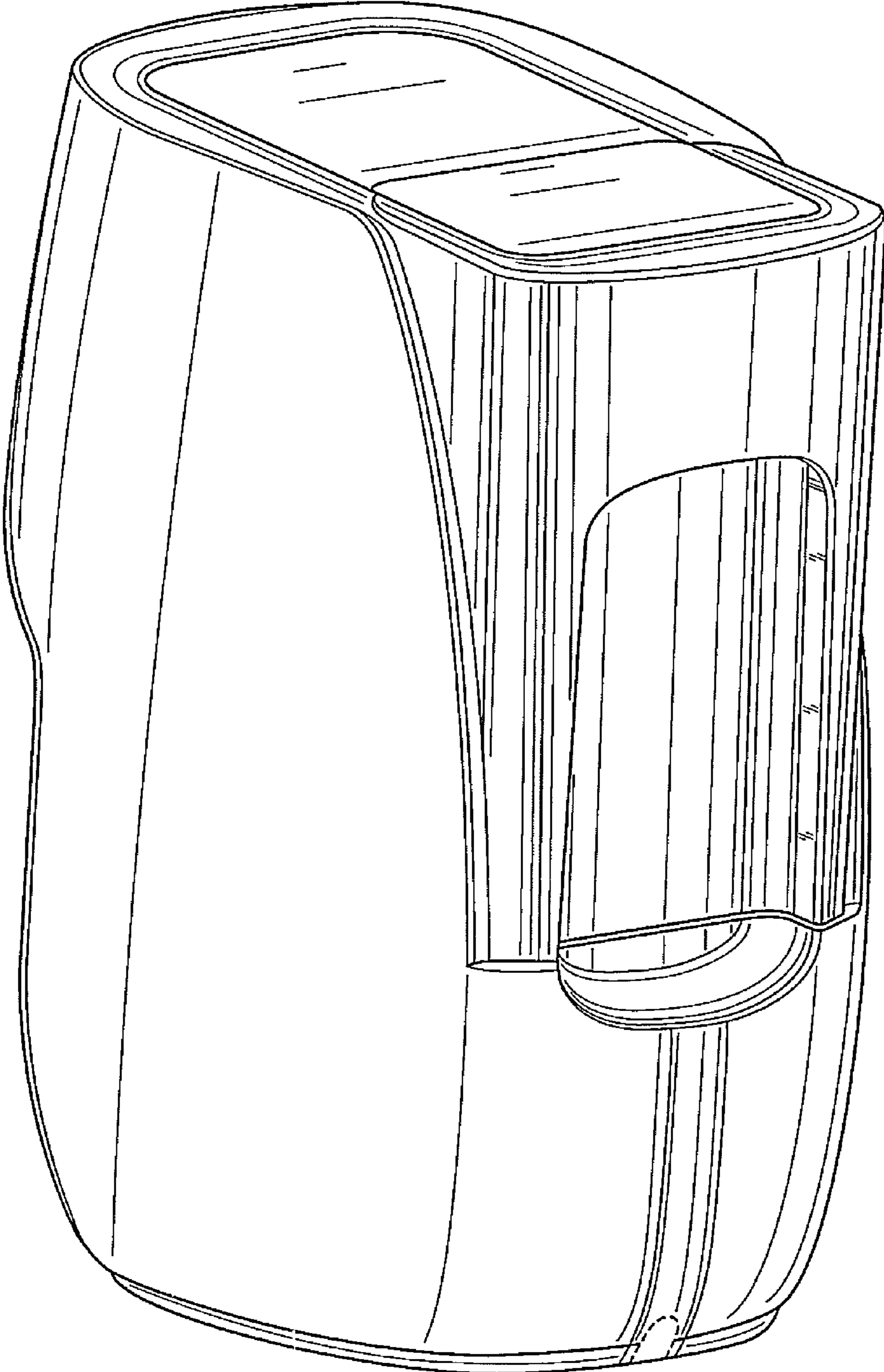

FIG. 8