



US00D744740S

(12) **United States Design Patent**  
**Kenison**

(10) **Patent No.:** **US D744,740 S**

(45) **Date of Patent:** **\*\* Dec. 8, 2015**

(54) **DETACHABLE SHOE STRAP**

(71) Applicant: **Emily Karal Kenison**, New York, NY  
(US)

(72) Inventor: **Emily Karal Kenison**, New York, NY  
(US)

(\*\*) Term: **15 Years**

(21) Appl. No.: **29/533,665**

(22) Filed: **Jul. 20, 2015**

(51) **LOC (10) Cl.** ..... **02-99**

(52) **U.S. Cl.**  
USPC ..... **D2/978**

(58) **Field of Classification Search**

USPC ..... D2/896, 916, 925, 926, 927, 928, 929,  
D2/930, 931, 932, 933, 935, 936, 943, 944,  
D2/946, 969, 971, 976, 977, 978; 36/83,  
36/97, 136, 45, 50.1, 57  
CPC ..... A43B 3/0078; A43B 3/12; A43B 3/122;  
A43B 3/124; A43B 3/126; A43B 3/26;  
A43B 3/0052; A43B 23/24; A43C 11/1493;  
A43C 11/00; A43C 11/002; A43C 11/004;  
A43C 11/006; A43C 1/00; A43C 1/02;  
A43C 1/04; A44B 11/00

See application file for complete search history.

(56) **References Cited**

**U.S. PATENT DOCUMENTS**

736,194 A \* 8/1903 Bassett ..... A43B 3/126  
36/11.5  
1,103,108 A \* 7/1914 Van Wie ..... A43C 15/063  
36/113  
D53,233 S \* 4/1919 Benedetti ..... D2/946  
1,428,232 A \* 9/1922 Holmen ..... A43B 23/227  
36/113  
D91,534 S \* 2/1934 Morali ..... D2/930  
D92,865 S \* 7/1934 Morali ..... D2/930  
D99,057 S \* 3/1936 Strassburger ..... D2/930  
D141,114 S \* 5/1945 Gordon ..... D2/918  
D145,684 S \* 10/1946 Ziniti ..... D2/930  
D253,498 S \* 11/1979 Katz ..... D2/930  
4,461,102 A 7/1984 DeVincentis

5,992,058 A 11/1999 Jneid  
D525,417 S \* 7/2006 Kelsey ..... D2/946  
7,272,899 B1 9/2007 Marak  
D561,459 S \* 2/2008 Weitzman ..... D2/927  
D572,456 S \* 7/2008 Guers-Neyrud ..... D2/917  
D572,458 S \* 7/2008 Choi ..... D2/971  
D594,220 S \* 6/2009 McDaniel ..... D2/971  
D634,105 S \* 3/2011 Cheshire ..... D2/925  
D654,671 S \* 2/2012 Coleman ..... D2/946  
D668,851 S \* 10/2012 Wang ..... D2/946  
D694,995 S \* 12/2013 Nguyen ..... D2/916  
D732,286 S \* 6/2015 Romo ..... D2/946  
2010/0299960 A1 12/2010 Nyamuswa  
2013/0326907 A1 12/2013 Ahanotu

**OTHER PUBLICATIONS**

Sassy Straps New Jersey, United States www.sassystraps.com PDF  
attached, dated Jul. 19, 2015.

\* cited by examiner

*Primary Examiner* — Elizabeth J Oswecki

(74) *Attorney, Agent, or Firm* — Brooklyn Law IP Clinic;  
Serge Krimnus; Suzanne A. Mourad

(57) **CLAIM**

The ornamental design for a detachable shoe strap, as shown  
and described.

**DESCRIPTION**

FIG. 1 is a top perspective view of a detachable shoe strap  
showing my new design;  
FIG. 2 is a bottom perspective view thereof;  
FIG. 3 is a front elevation view thereof;  
FIG. 4 is a right side elevation view thereof;  
FIG. 5 is a rear elevation view thereof;  
FIG. 6 is a left side elevation view thereof;  
FIG. 7 is a top plan view thereof; and,  
FIG. 8 is a bottom plan view thereof.

The broken lines showing a leg, foot and shoe in FIGS. 1 and  
2 illustrate environmental subject matter and form no part of  
the claimed design. The broken lines on the surface of the  
detachable shoe strap represent thread stitching.

**1 Claim, 5 Drawing Sheets**

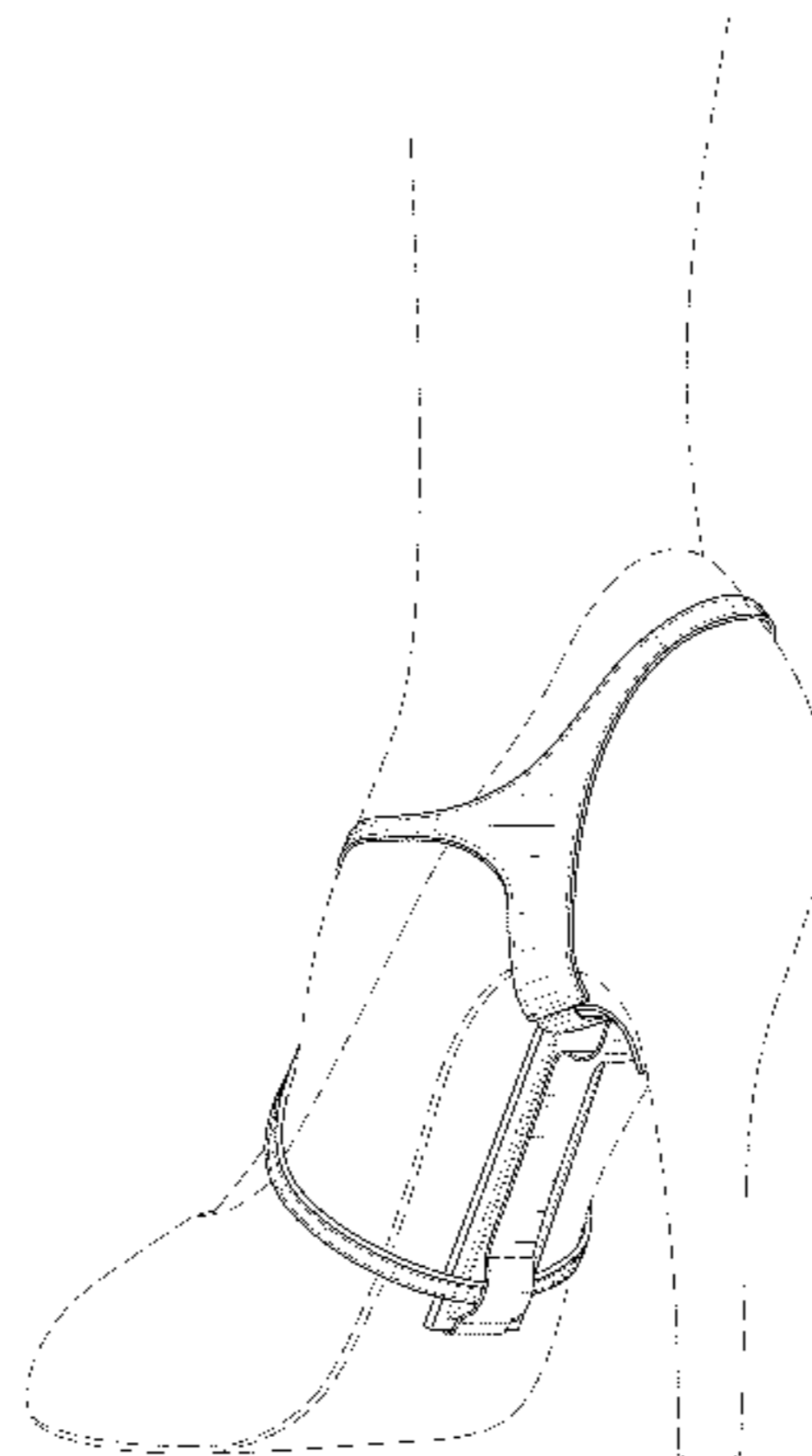
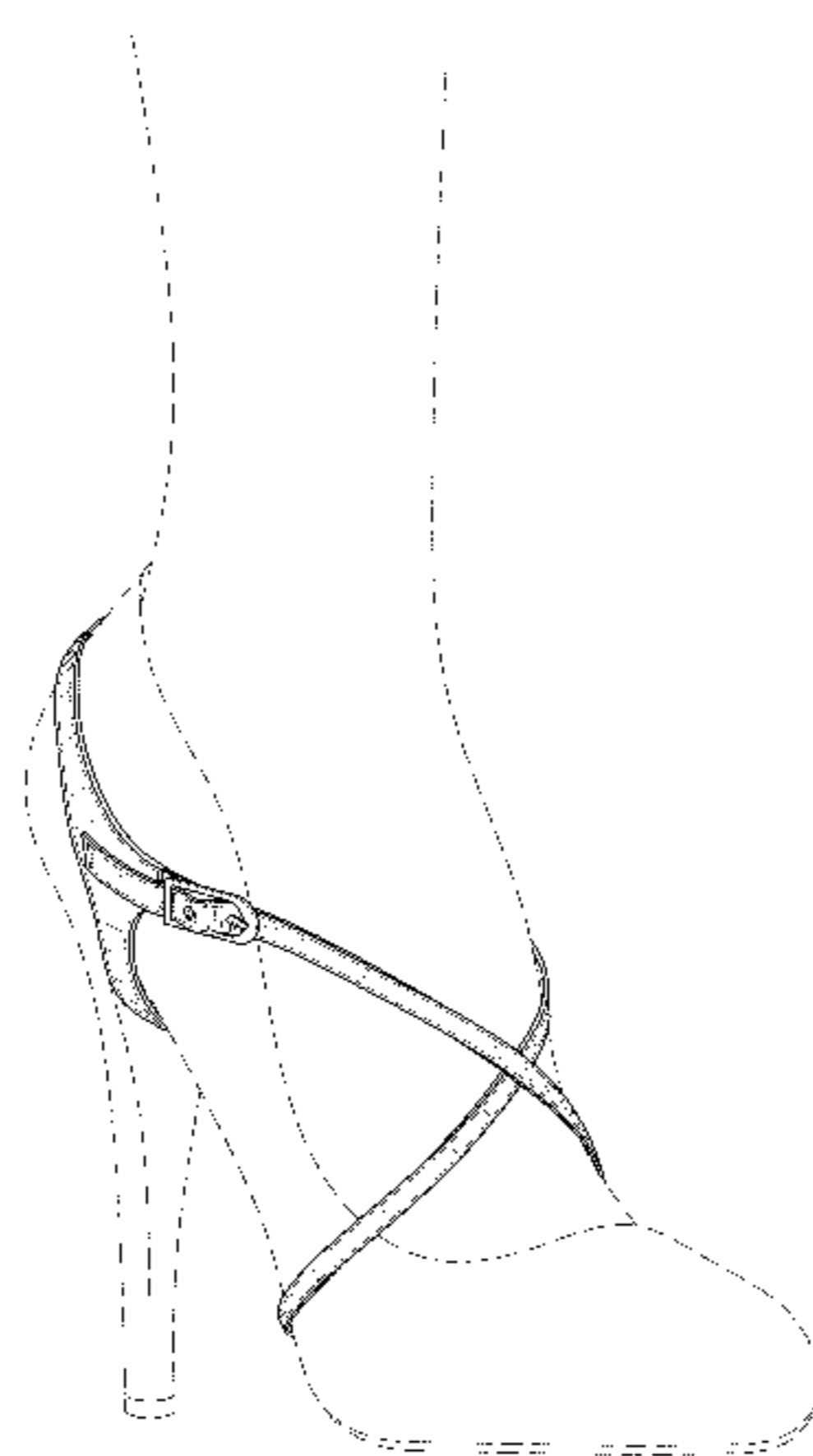

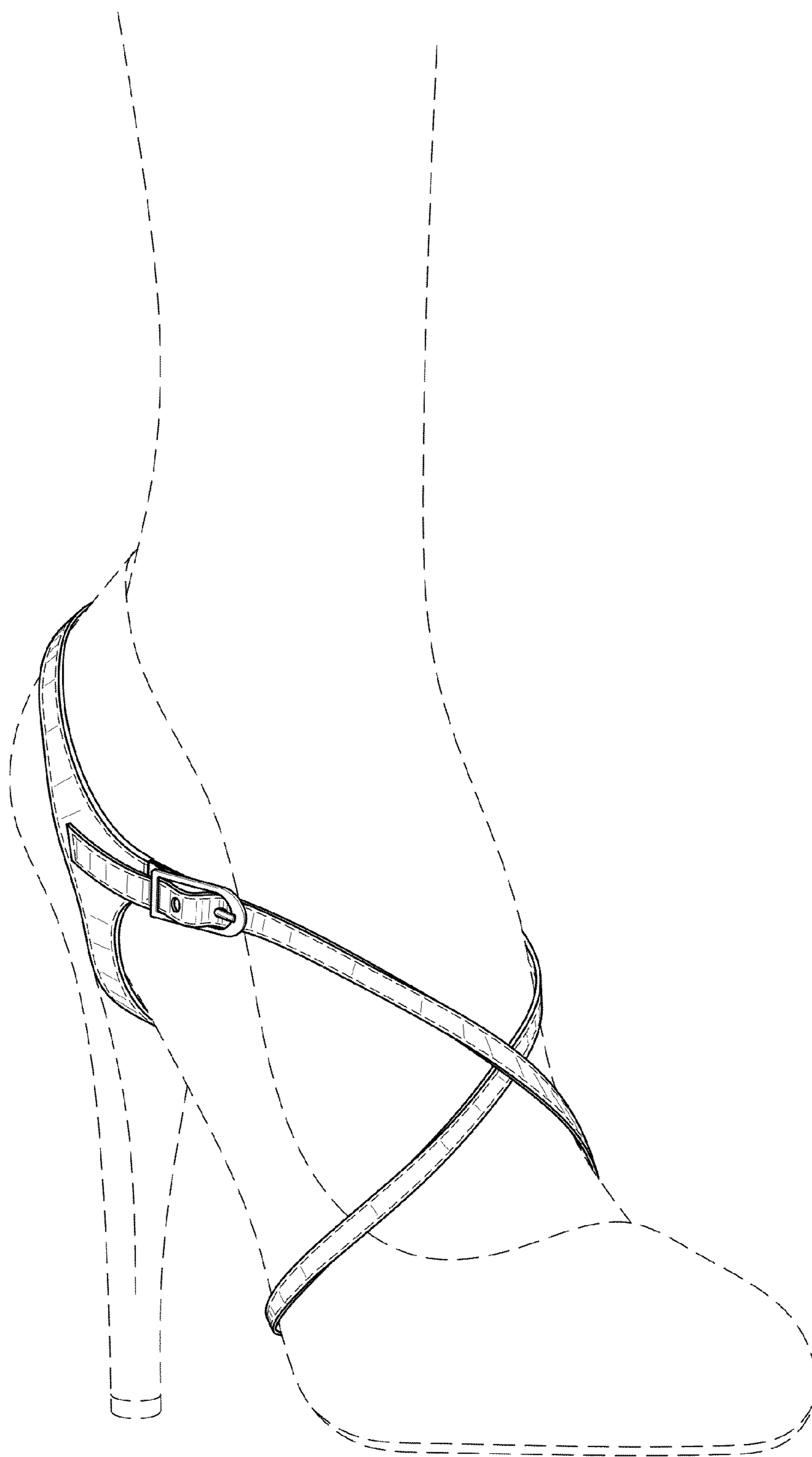

FIG. 1

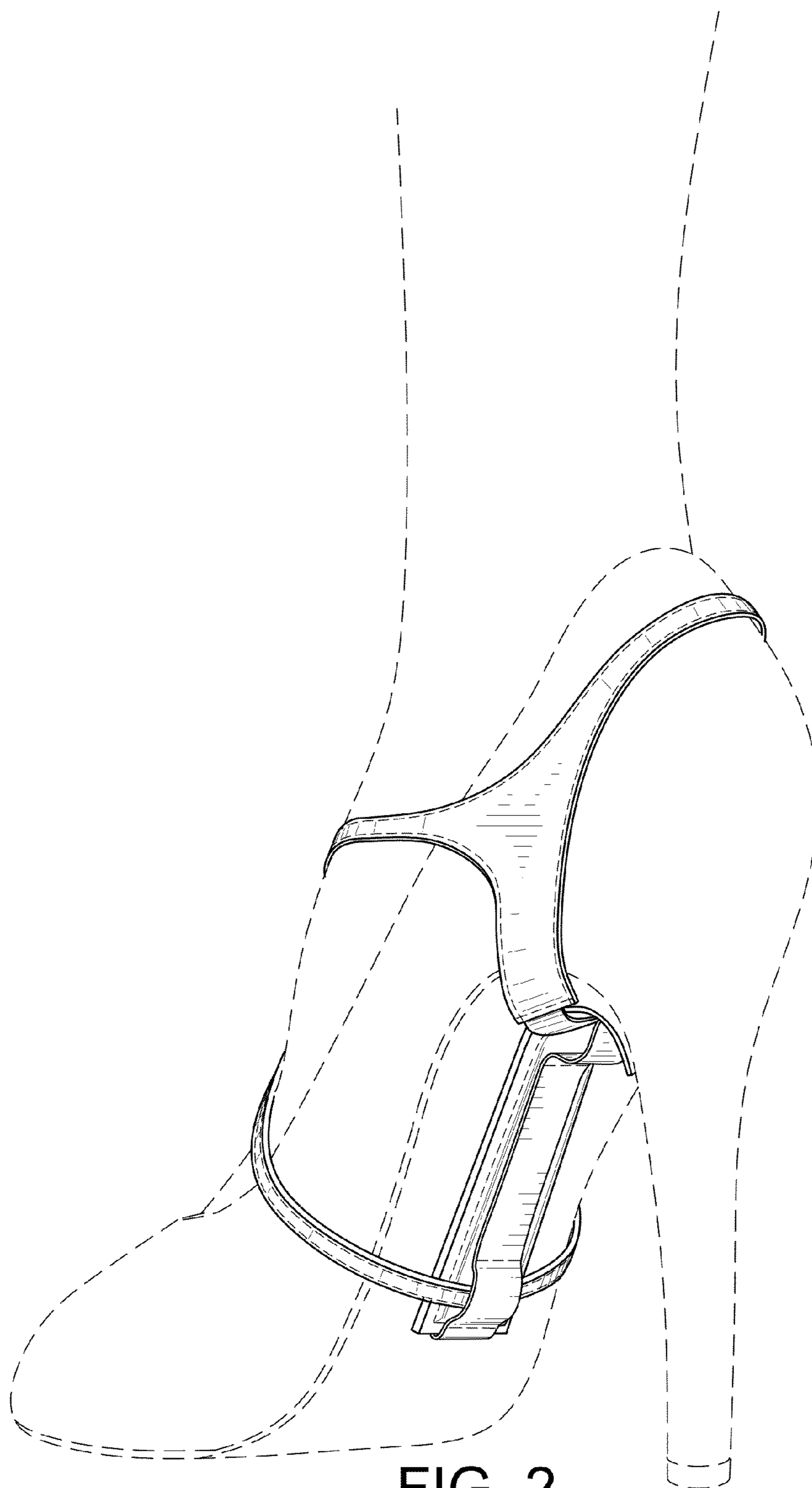

FIG. 2

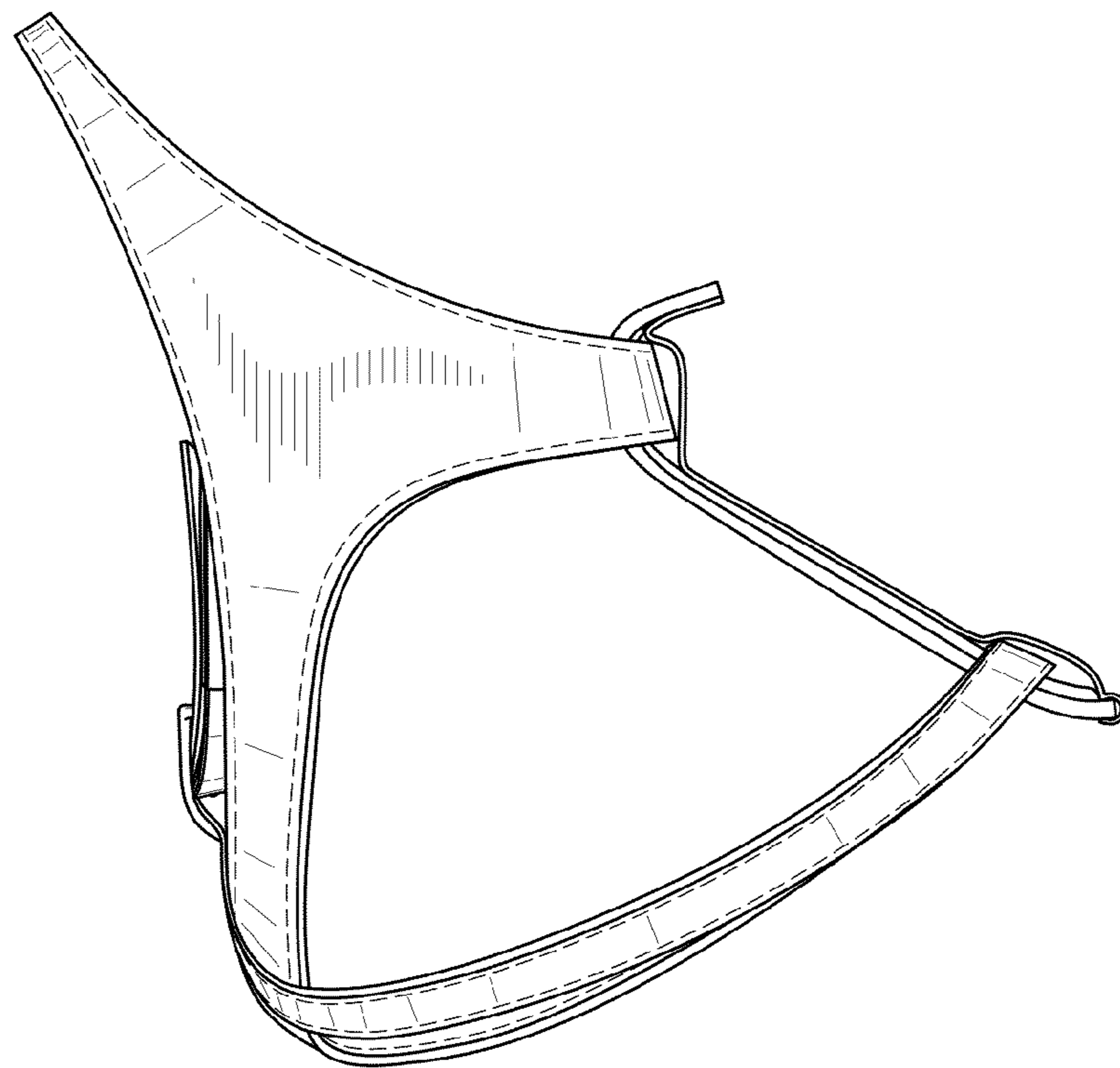

FIG. 4

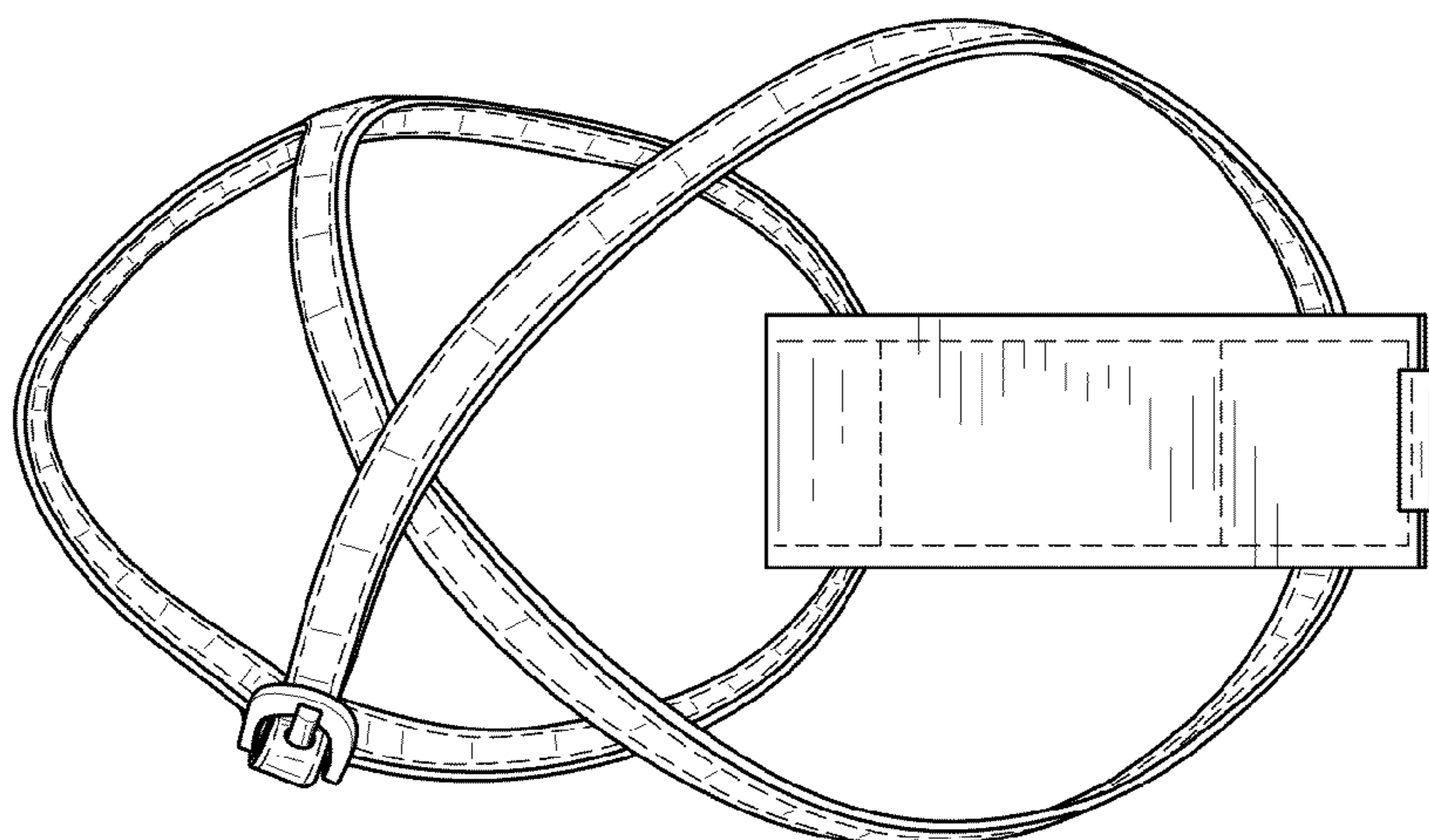

FIG. 3

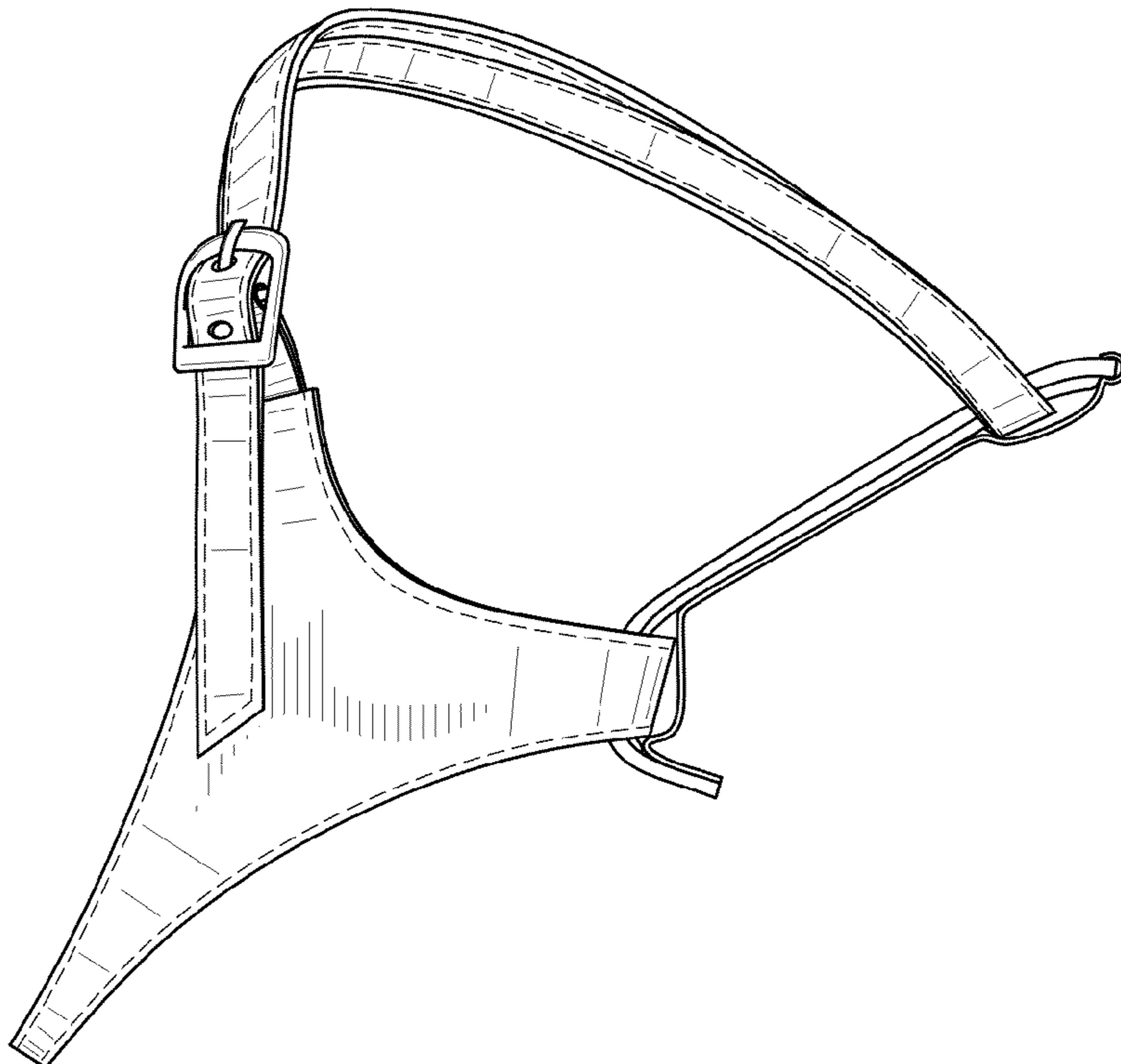

FIG. 6

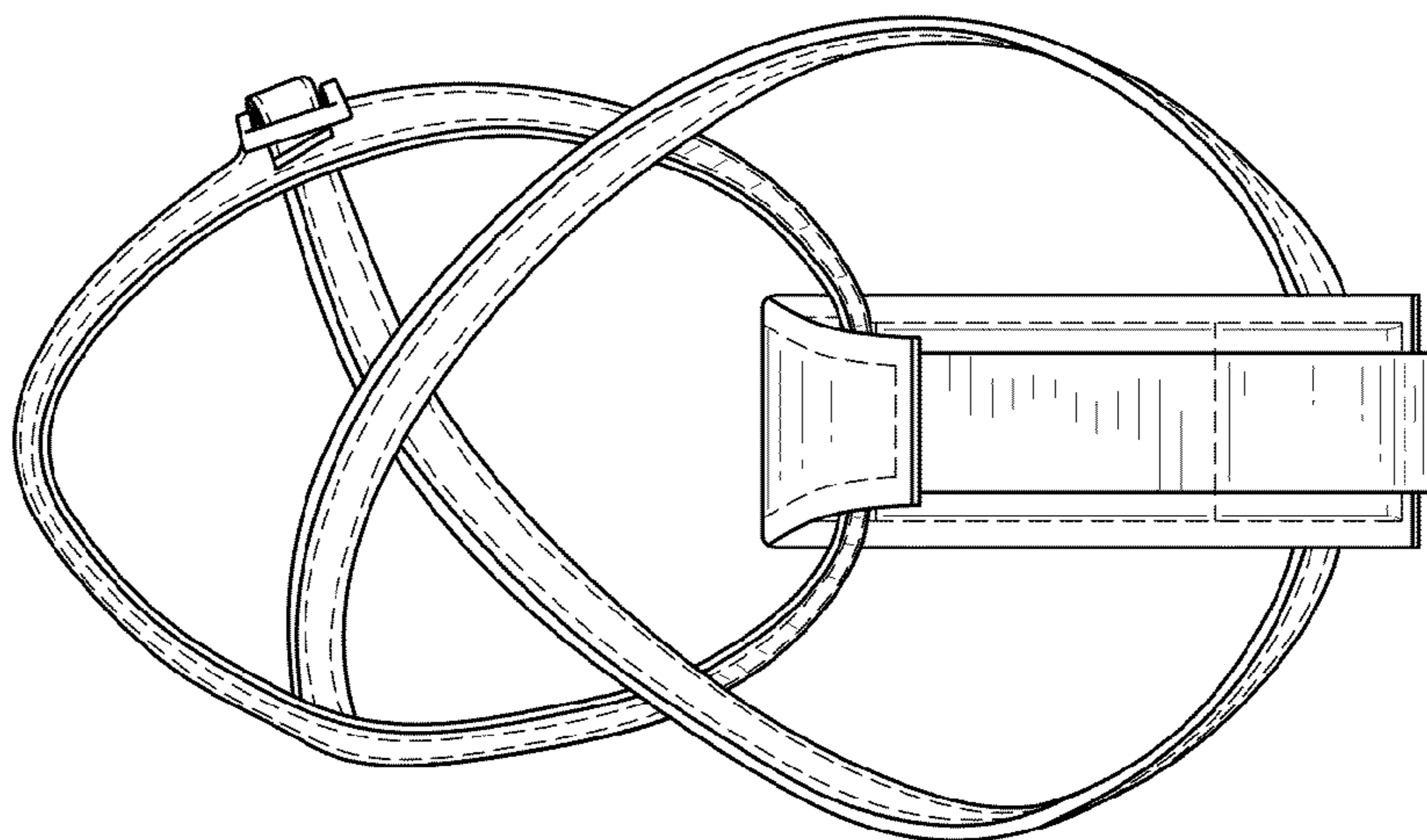

FIG. 5

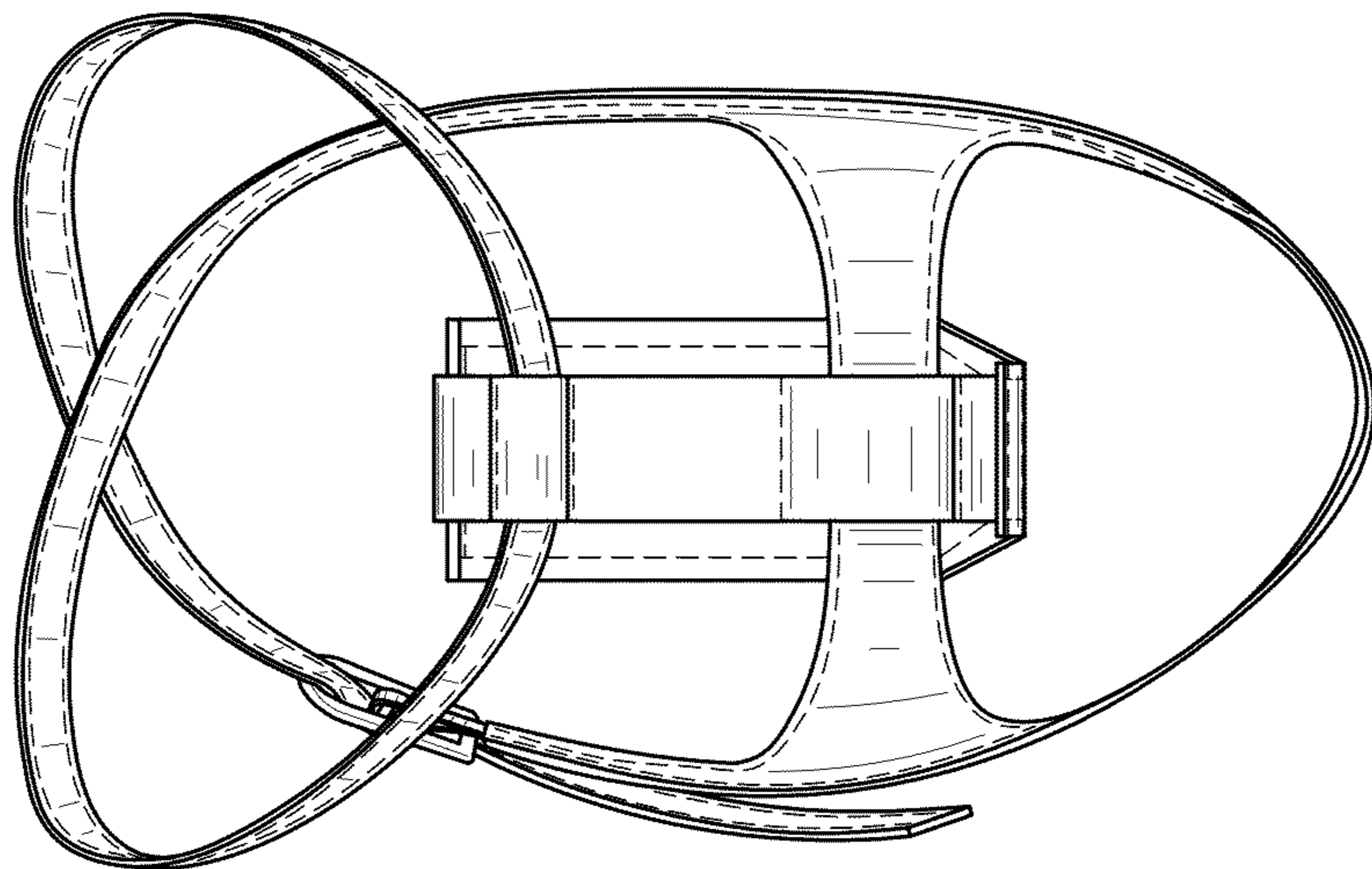

FIG. 8

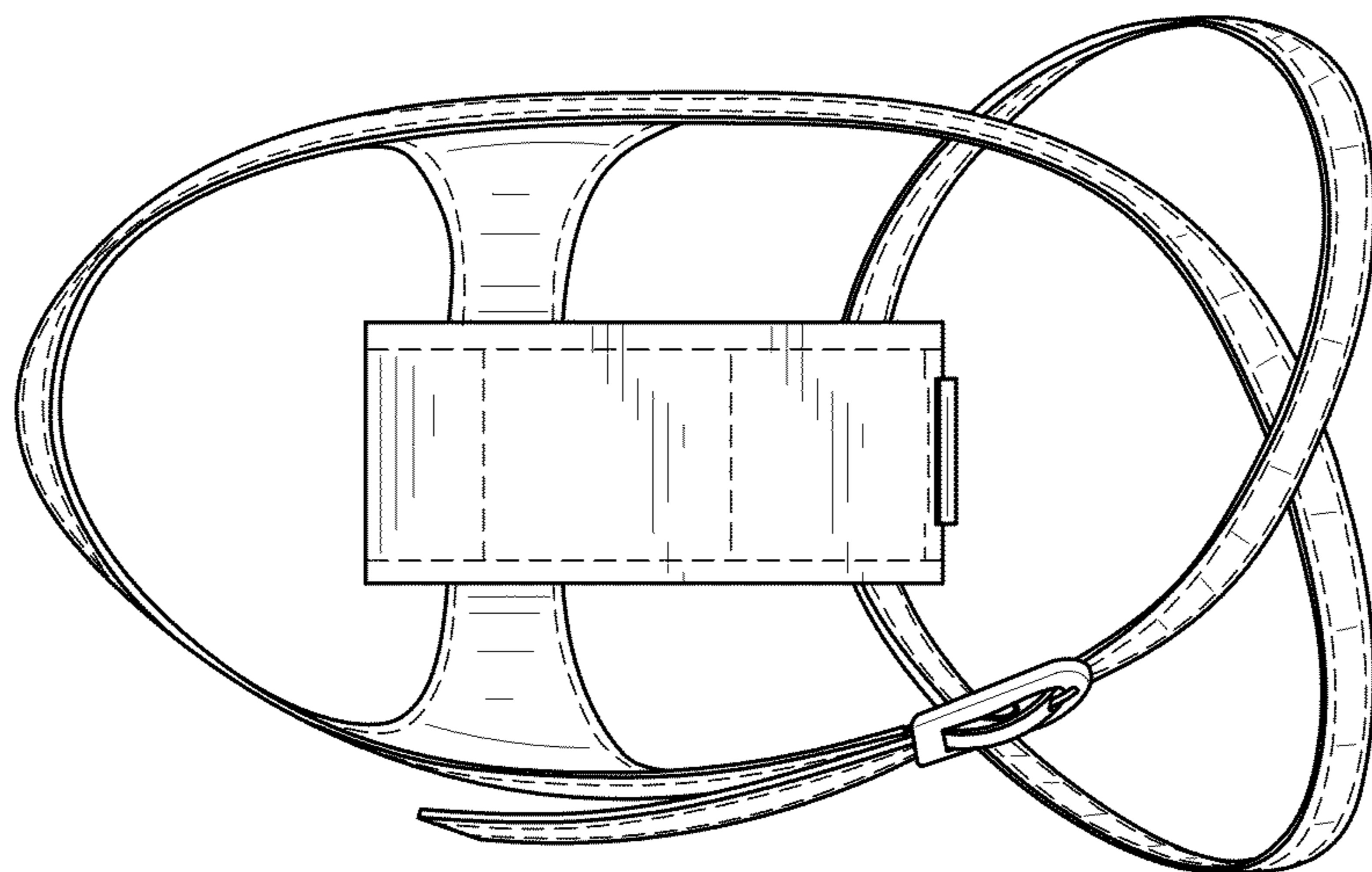

FIG. 7