



US00D744724S

(12) **United States Design Patent**  
**Borovicka**

(10) **Patent No.:** **US D744,724 S**  
(45) **Date of Patent:** **\*\* Dec. 8, 2015**

(54) **HOODED GARMENT**

(71) Applicant: **NIKE, Inc.**, Beaverton, OR (US)

(72) Inventor: **Vanessa L. Borovicka**, Lake Oswego, OR (US)

(73) Assignee: **NIKE, Inc.**, Beaverton, OR (US)

(\*\*) Term: **14 Years**

(21) Appl. No.: **29/520,858**

(22) Filed: **Mar. 18, 2015**

(51) **LOC (10) Cl.** ..... **02-02**

(52) **U.S. Cl.**  
USPC ..... **D2/828**

(58) **Field of Classification Search**  
USPC ..... D2/717, 731, 749, 750, 755, 828–831,  
D2/833, 834, 836, 839, 840, 841  
See application file for complete search history.

(56) **References Cited**

U.S. PATENT DOCUMENTS

D129,909 S	10/1941	Turcotte	
D130,379 S	11/1941	Leventhal	
D148,682 S	2/1948	Etkin	
D306,511 S	3/1990	Jones	
D478,708 S *	8/2003	Miros	D2/831
D479,902 S *	9/2003	Brown	D2/831
D551,429 S	9/2007	Wager	
D580,630 S	11/2008	Adams et al.	
D617,080 S *	6/2010	Geiss	D2/841
D630,001 S *	1/2011	Brown	D2/741
D633,692 S *	3/2011	Lawrence	D2/831
D635,332 S	4/2011	DeRobertis	
D636,973 S *	5/2011	Smith	D2/830
D638,201 S	5/2011	Gosse	
D653,836 S	2/2012	Woyshner et al.	
D662,284 S	6/2012	Lam	
D663,101 S	7/2012	Best et al.	
D665,152 S *	8/2012	Morales	D2/840
D685,160 S	7/2013	Savage	
D695,491 S *	12/2013	Hawkins	D2/750

D698,522 S	2/2014	Roberts et al.	
D698,523 S	2/2014	Roberts et al.	
D698,524 S	2/2014	Roberts et al.	
D698,525 S	2/2014	Roberts et al.	
D701,368 S *	3/2014	Borovicka	D2/831

(Continued)

OTHER PUBLICATIONS

Nike Apparel Catalog, 2010 Holiday Men's Performance, p. 16, published date unknown, but prior to the filing date of the present application, NIKE, Inc., USA.

(Continued)

Primary Examiner — Rashida Johnson

(74) Attorney, Agent, or Firm — Banner & Witcoff, Ltd.

(57) **CLAIM**

The ornamental design for a hooded garment, as shown and described.

**DESCRIPTION**

FIG. 1 is a front left perspective view of a hooded garment showing my new design in an in-use configuration with a hood in an up position;  
FIG. 2 is a front right perspective view thereof;  
FIG. 3 is a front view thereof;  
FIG. 4 is a rear view thereof;  
FIG. 5 is a left side view thereof;  
FIG. 6 is a right side view thereof; and,  
FIG. 7 is a top view thereof.

The broken lines in immediately adjacent to the shaded area represent unclaimed boundaries of the design. The unshaded regions, demarcated by broken lines, represent unclaimed portions of the hooded garment and form no part of the claimed design. The contrast in shading represents a contrast in appearance only and does not represent any particular color, material, texture or finish. The broken lines showing the remainder of the hooded garment are for environmental purposes only and form no part of the claimed design.

**1 Claim, 7 Drawing Sheets**

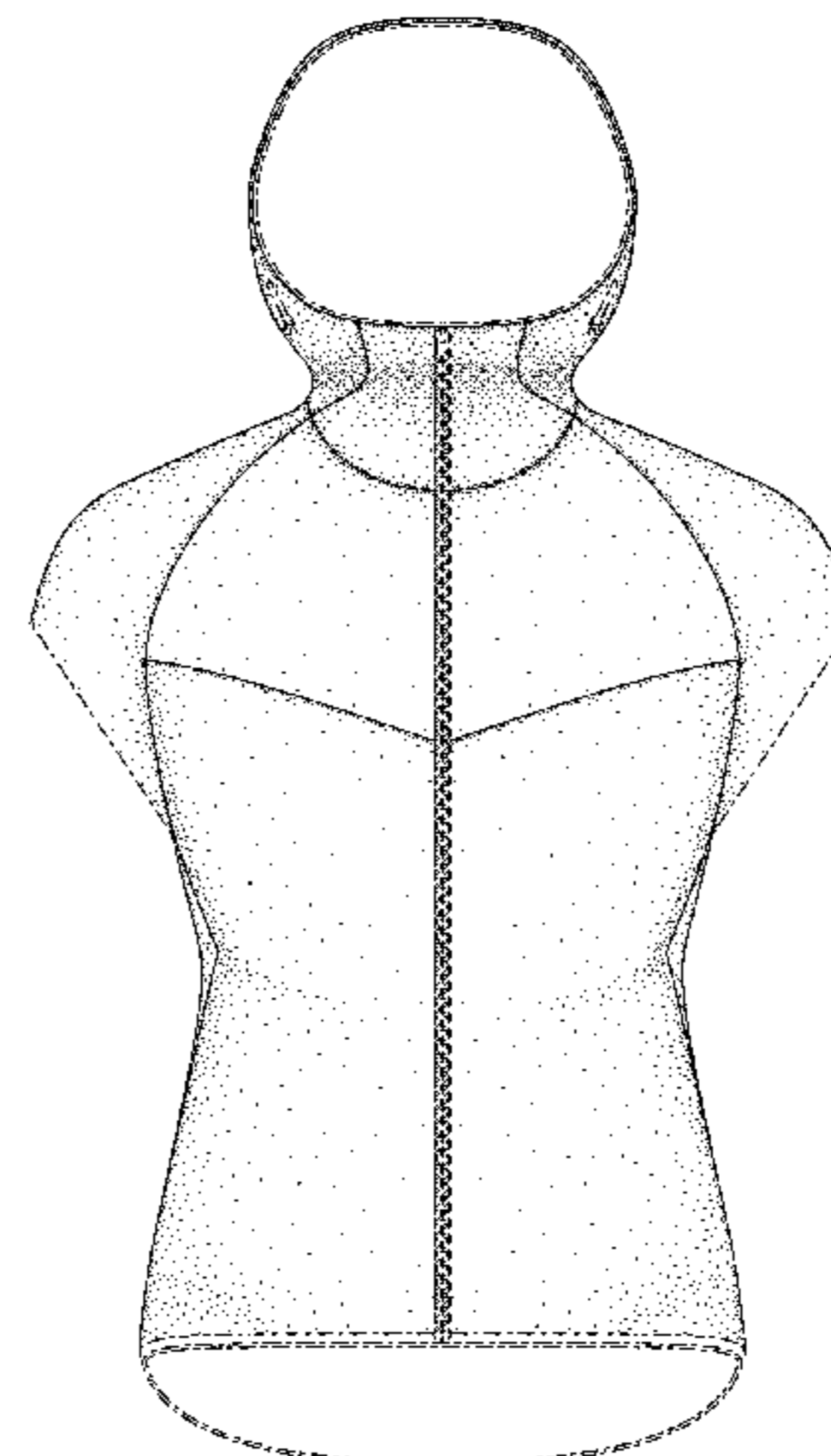
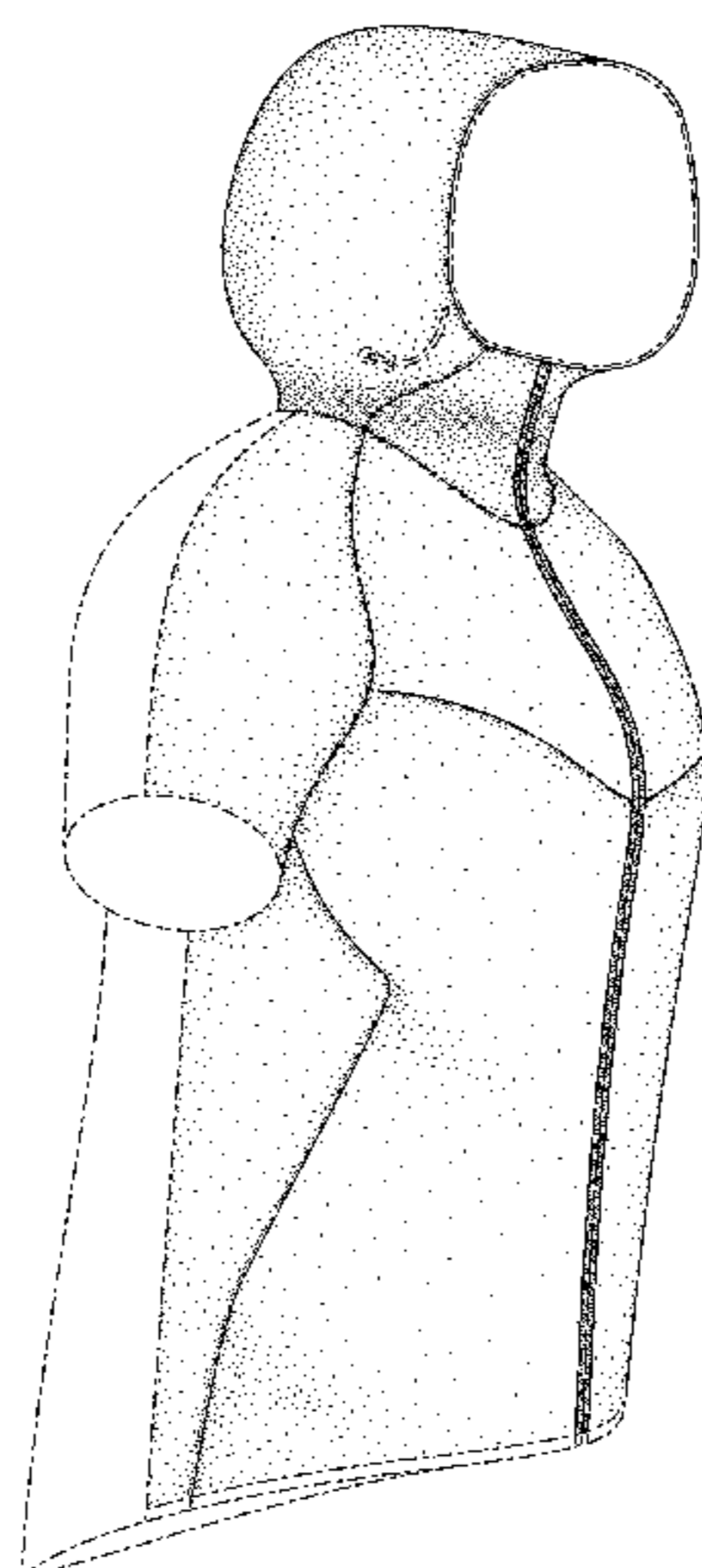

(56)

**References Cited**

U.S. PATENT DOCUMENTS

D703,922 S 5/2014 Roberts et al.  
D704,924 S 5/2014 Roberts et al.  
D707,923 S \* 7/2014 Borovicka ..... D2/831  
D714,525 S 10/2014 Payne  
D714,527 S \* 10/2014 Borovicka ..... D2/839

D715,029 S 10/2014 Roberts et al.  
D736,497 S \* 8/2015 Harris ..... D2/831

OTHER PUBLICATIONS

Nike Apparel Catalog, 2010 Spring Sport Performance, p. 68, published May 2009, NIKE, Inc., USA.

\* cited by examiner

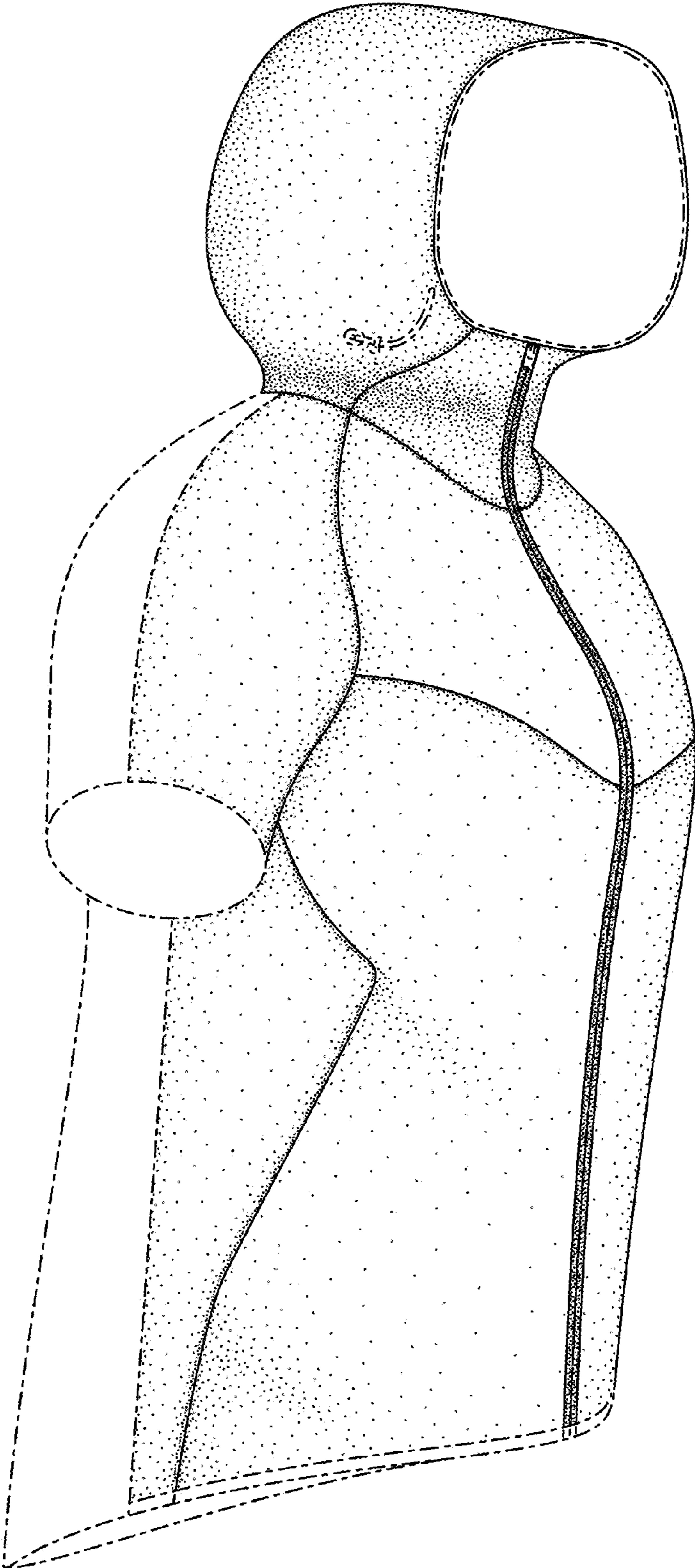

FIG. 1

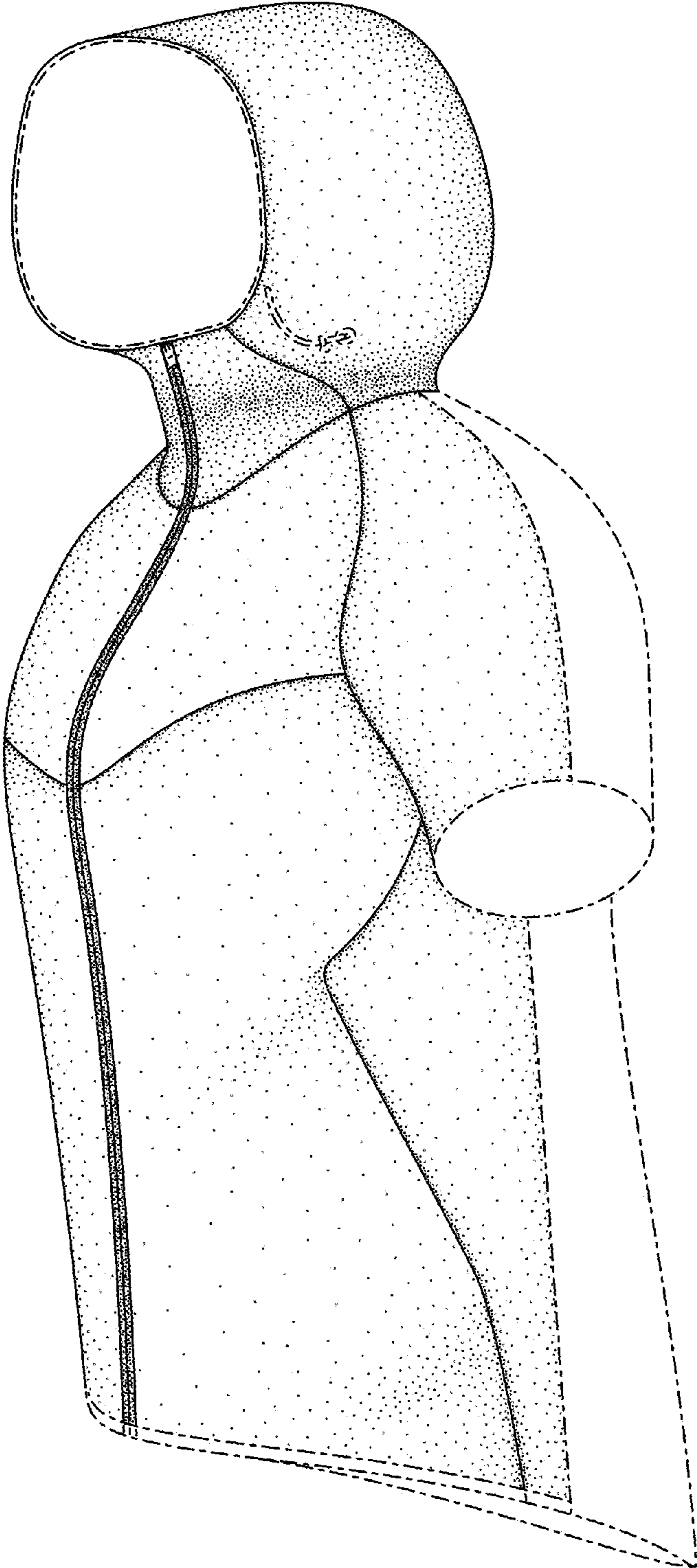

FIG. 2

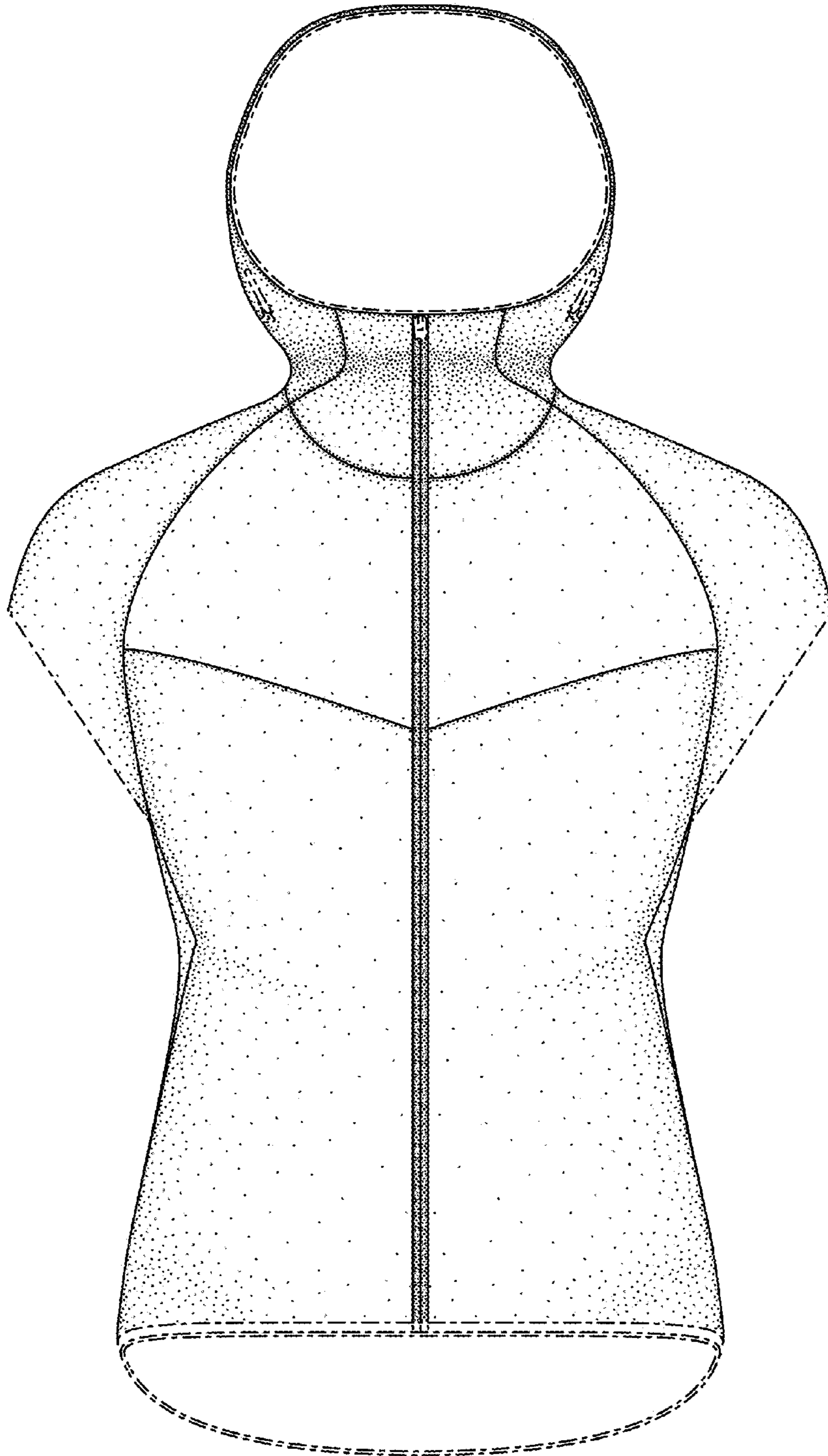

FIG. 3

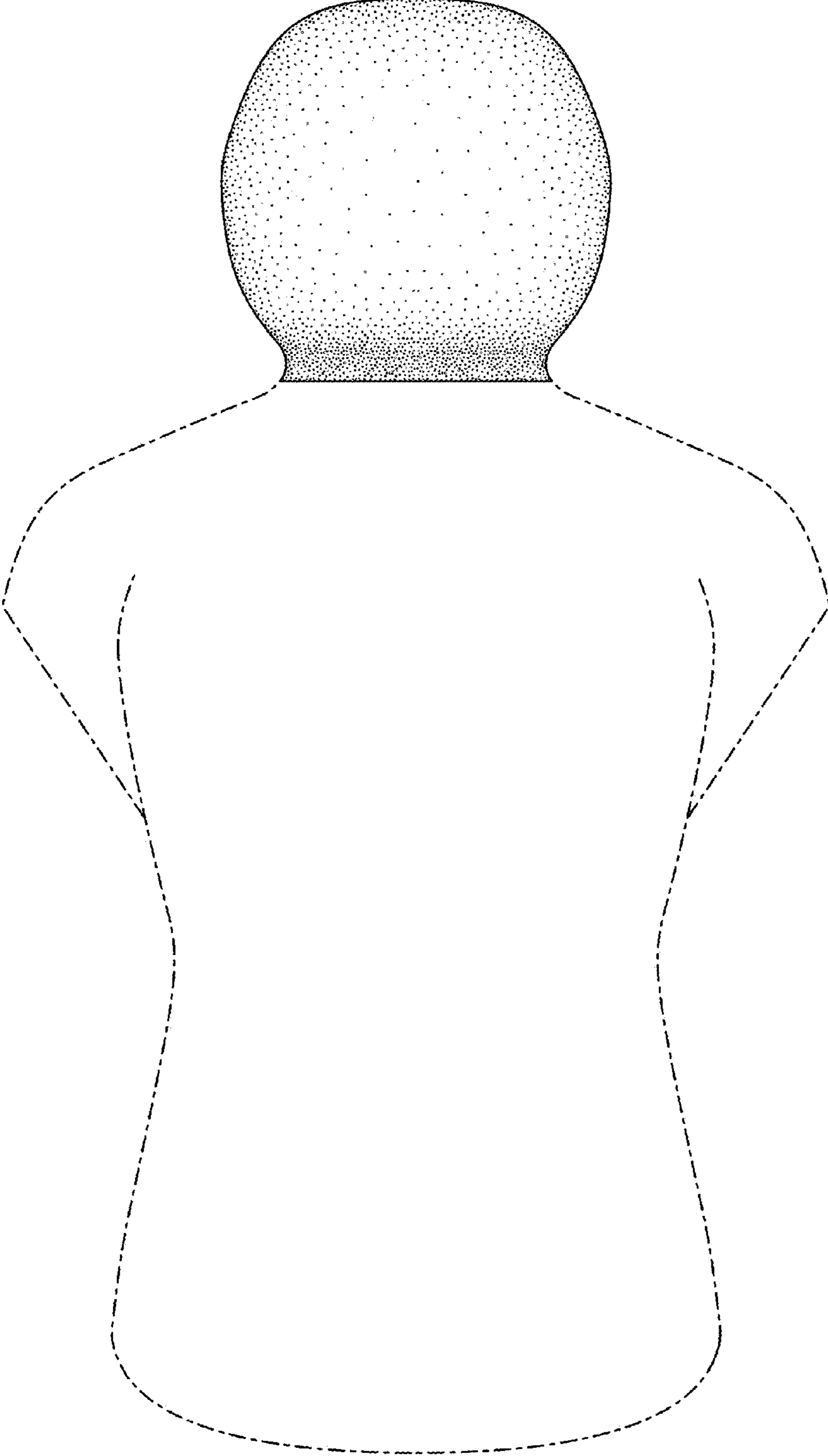

FIG. 4

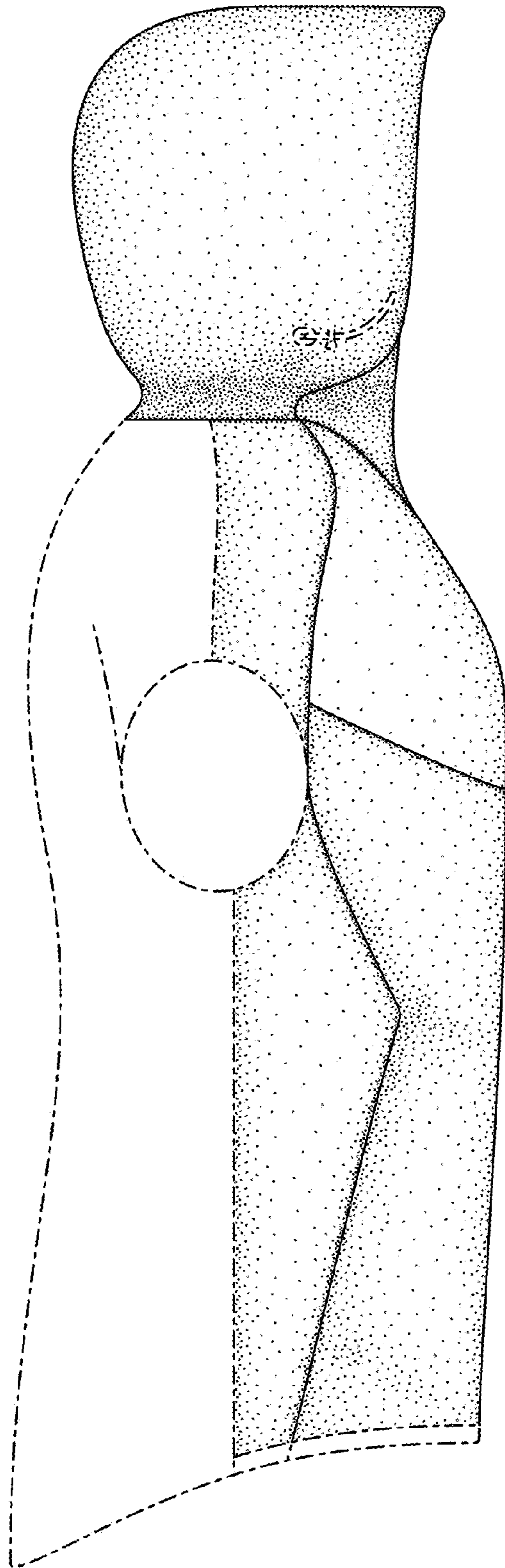

FIG. 5

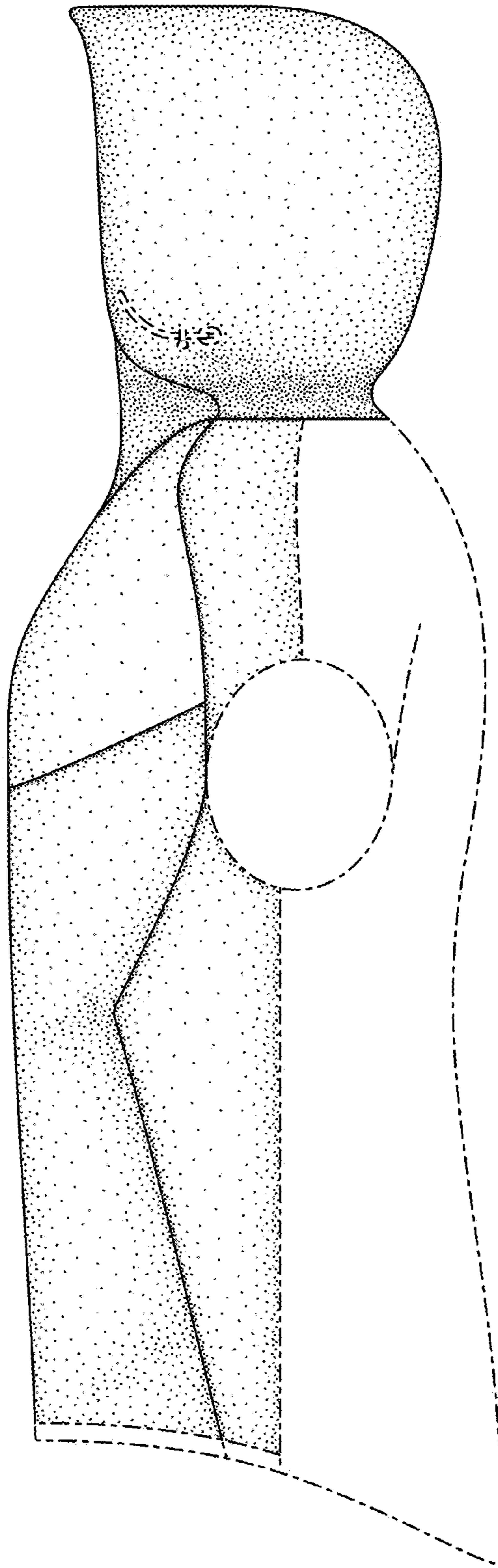

FIG. 6



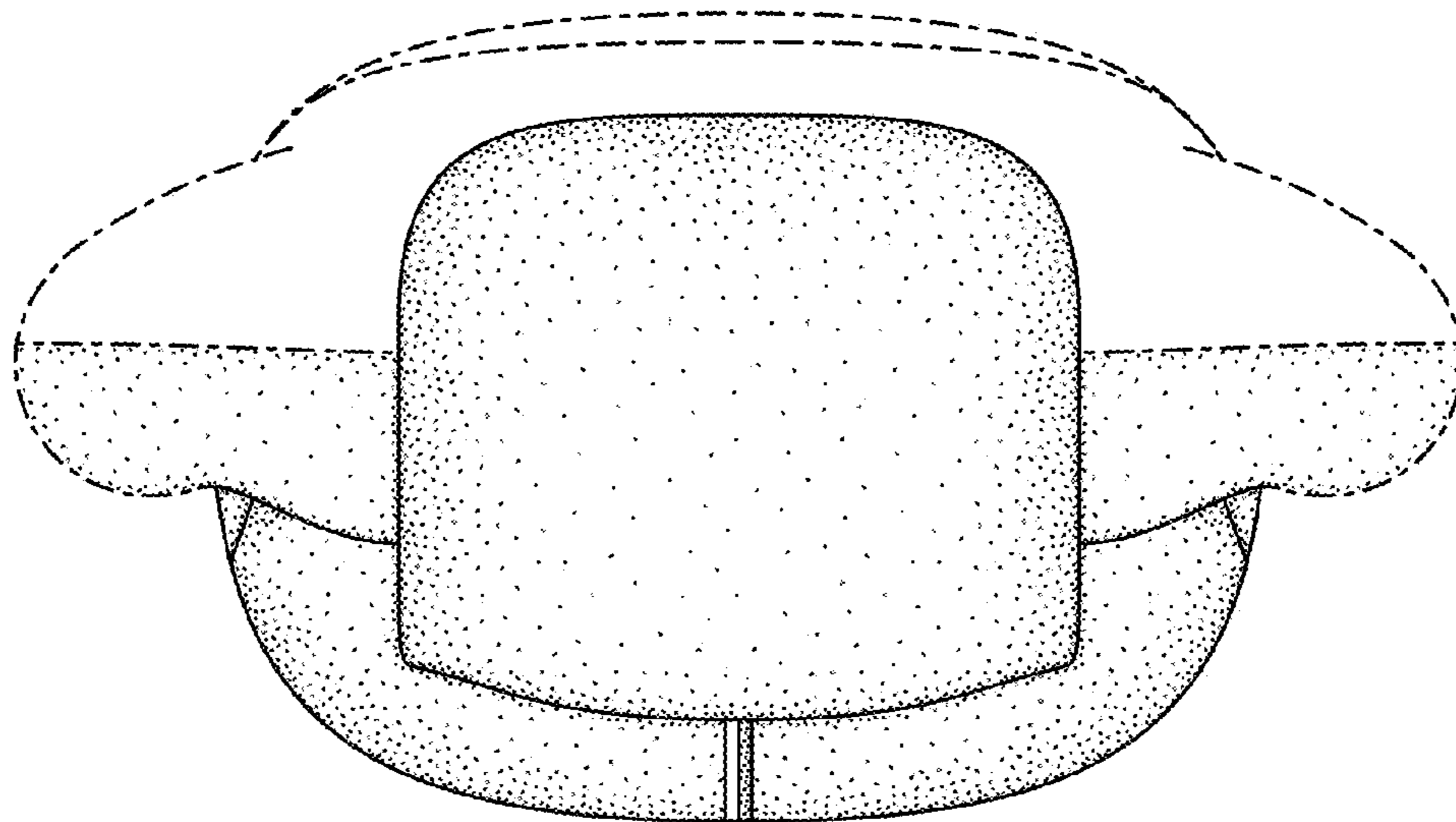

FIG. 7