



US00D744713S

(12) **United States Design Patent**  
**Della Polla**

(10) **Patent No.:** **US D744,713 S**  
(45) **Date of Patent:** **\*\* Dec. 1, 2015**

(54) **FURNITURE AND MATTRESS DOLLY**

(71) Applicant: **Michael Della Polla**, Kennesaw, GA  
(US)

(72) Inventor: **Michael Della Polla**, Kennesaw, GA  
(US)

(\*\*) Term: **14 Years**

(21) Appl. No.: **29/463,749**

(22) Filed: **Feb. 24, 2014**

(51) **LOC (10) Cl.** ..... **12-02**

(52) **U.S. Cl.**  
USPC ..... **D34/23**

(58) **Field of Classification Search**  
USPC ..... D34/12-27; 280/79.11, 79.3, 79.2;  
108/51.1, 51.3, 55.1, 56.1  
CPC ..... B62B 5/0083; B62B 3/002; B62B 3/006;  
B62B 3/00; B62B 3/10; B62B 3/0002  
See application file for complete search history.

(56) **References Cited**

**U.S. PATENT DOCUMENTS**

3,494,667	A *	2/1970	Schlapman et al.	298/5
D219,649	S *	1/1971	Saleman	D34/17
D221,633	S *	8/1971	Kotkowski	D34/23
D263,820	S *	4/1982	Levenberg	D34/23

D280,563	S *	9/1985	Cobb	D34/17
D291,037	S *	7/1987	Handler et al.	D3/279
D327,351	S *	6/1992	Dallas	D34/23
5,653,458	A *	8/1997	Chaparian	280/30
D395,533	S *	6/1998	Morison et al.	D34/38
D420,188	S *	2/2000	Betcher	D34/23
D536,499	S *	2/2007	Lucht	D34/12
D649,318	S *	11/2011	Renfrew et al.	D34/12
D668,418	S *	10/2012	Nicholson	D34/14
D668,419	S *	10/2012	Nicholson	D34/14
D679,466	S *	4/2013	McCullough	D34/17
D733,386	S *	6/2015	Della Polla	D34/23

\* cited by examiner

*Primary Examiner* — Cynthia Ramirez

(57) **CLAIM**

The ornamental design for a furniture and mattress dolly, as shown and described.

**DESCRIPTION**

FIG. 1 is a top perspective view of a furniture and mattress dolly showing my new design;  
FIG. 2 is a bottom perspective view thereof;  
FIG. 3 is a top plan view thereof;  
FIG. 4 is a bottom plan view thereof;  
FIG. 5 is a front elevational view, with the rear being a mirror image thereof; and,  
FIG. 6 is a left side elevational view, with the right side being a mirror image thereof.

**1 Claim, 5 Drawing Sheets**

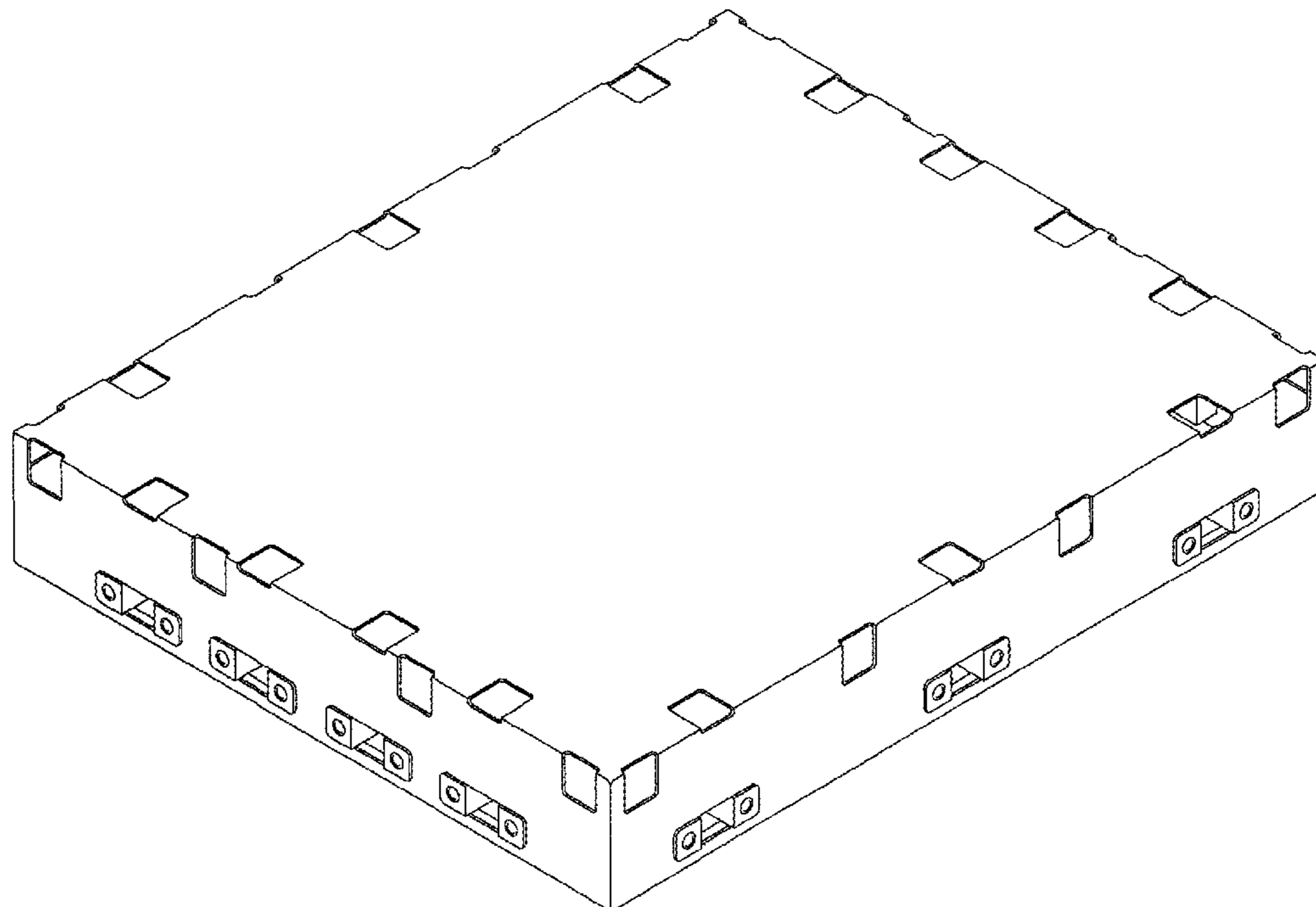

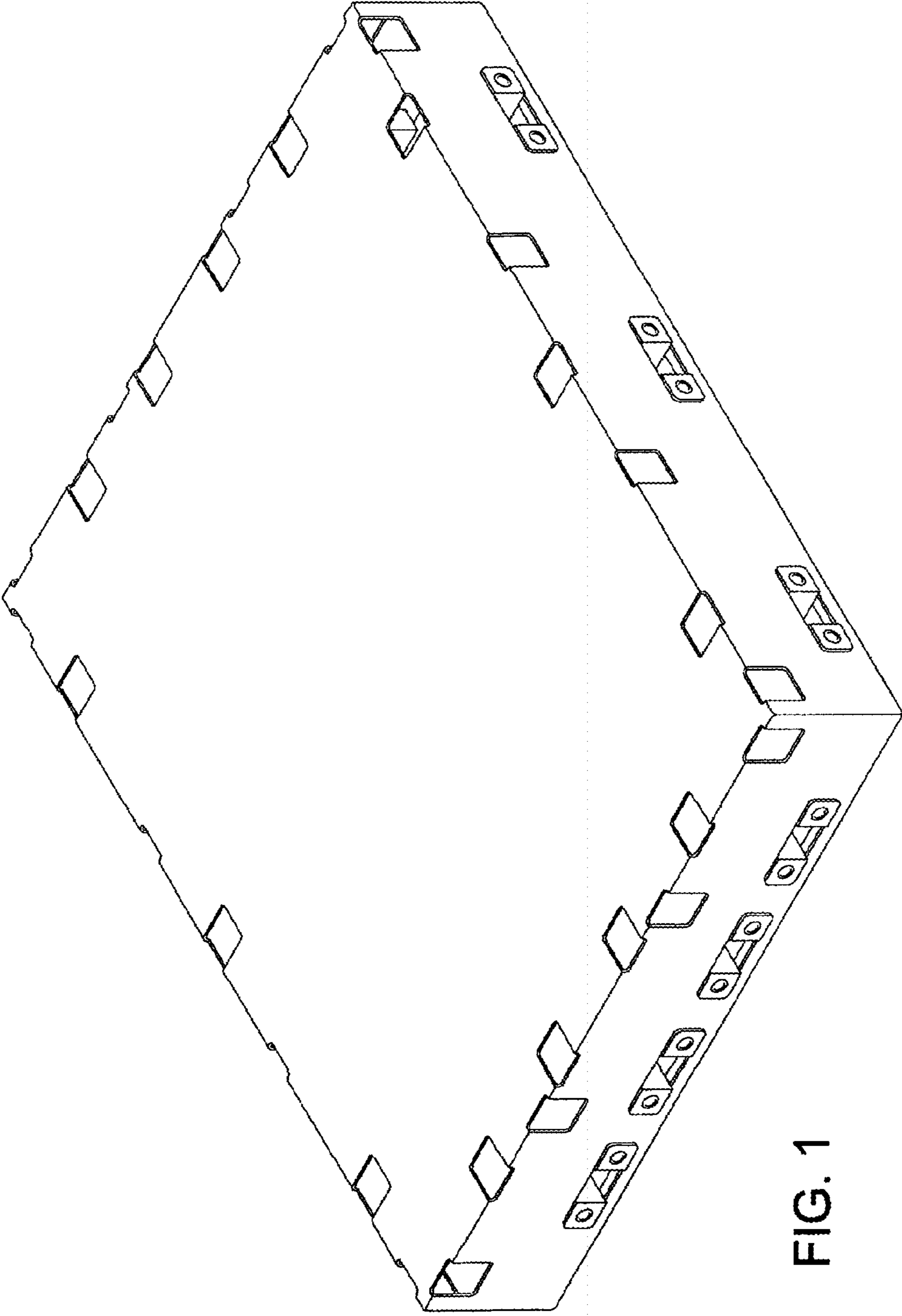

FIG. 1

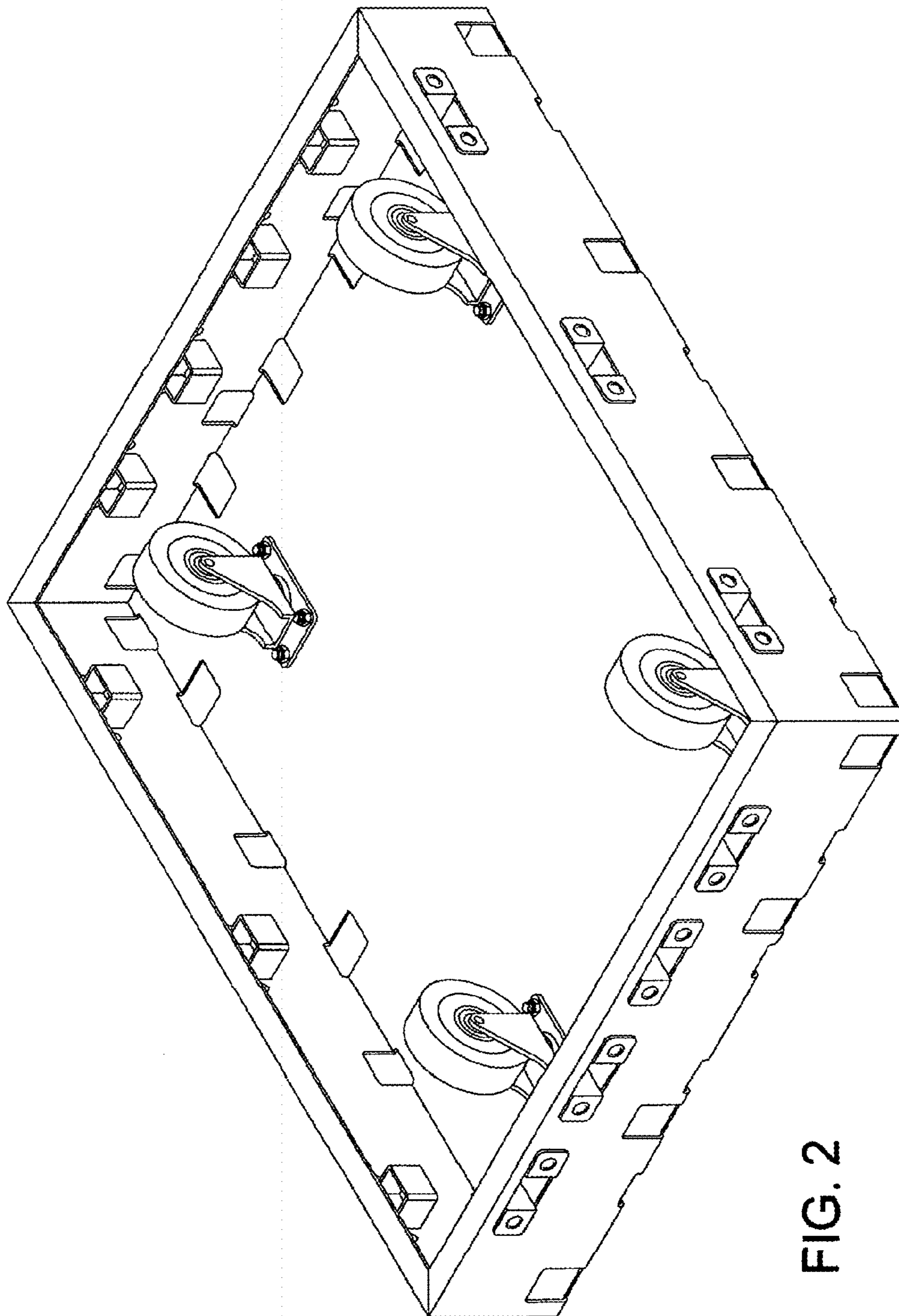

FIG. 2

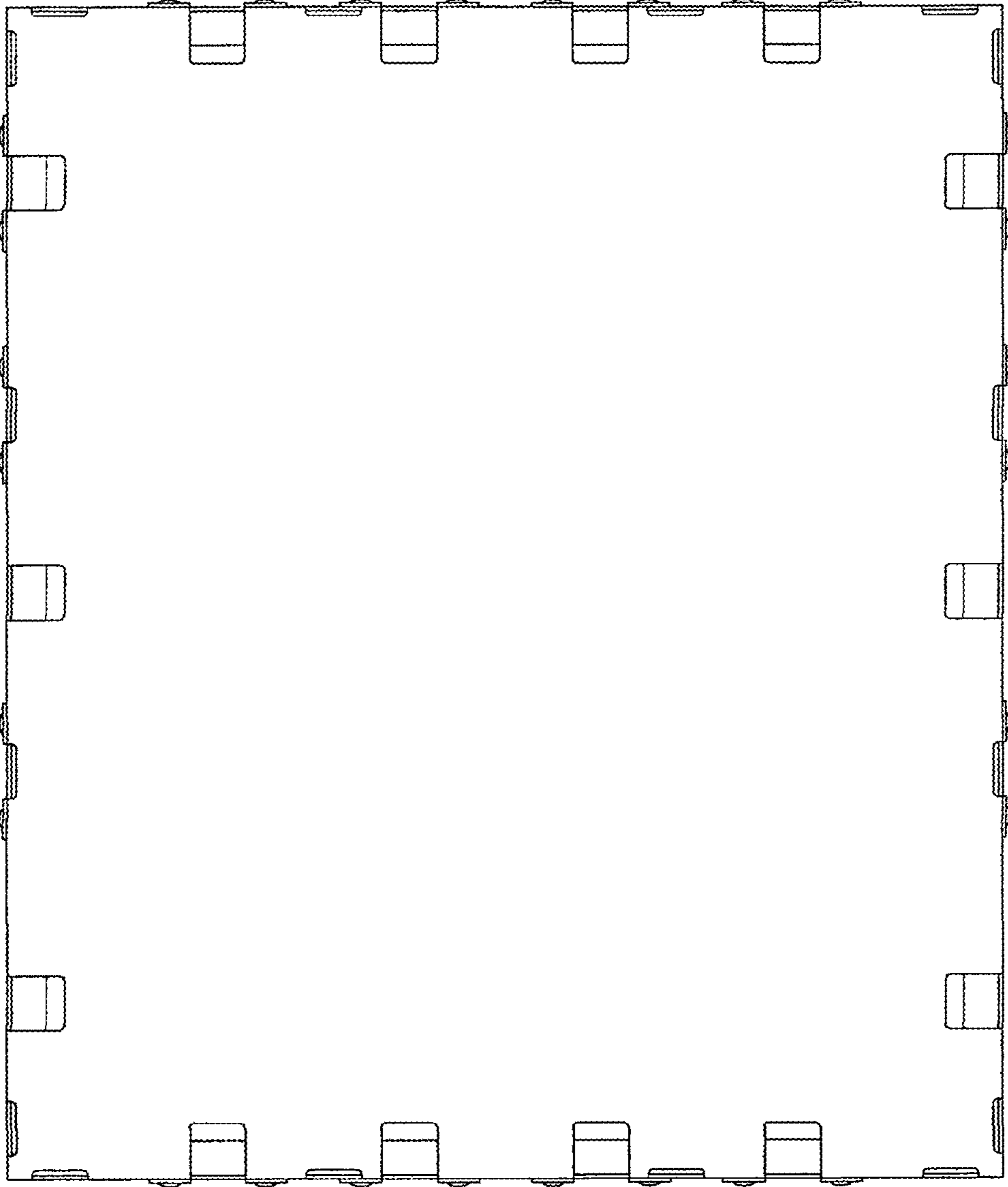

FIG. 3

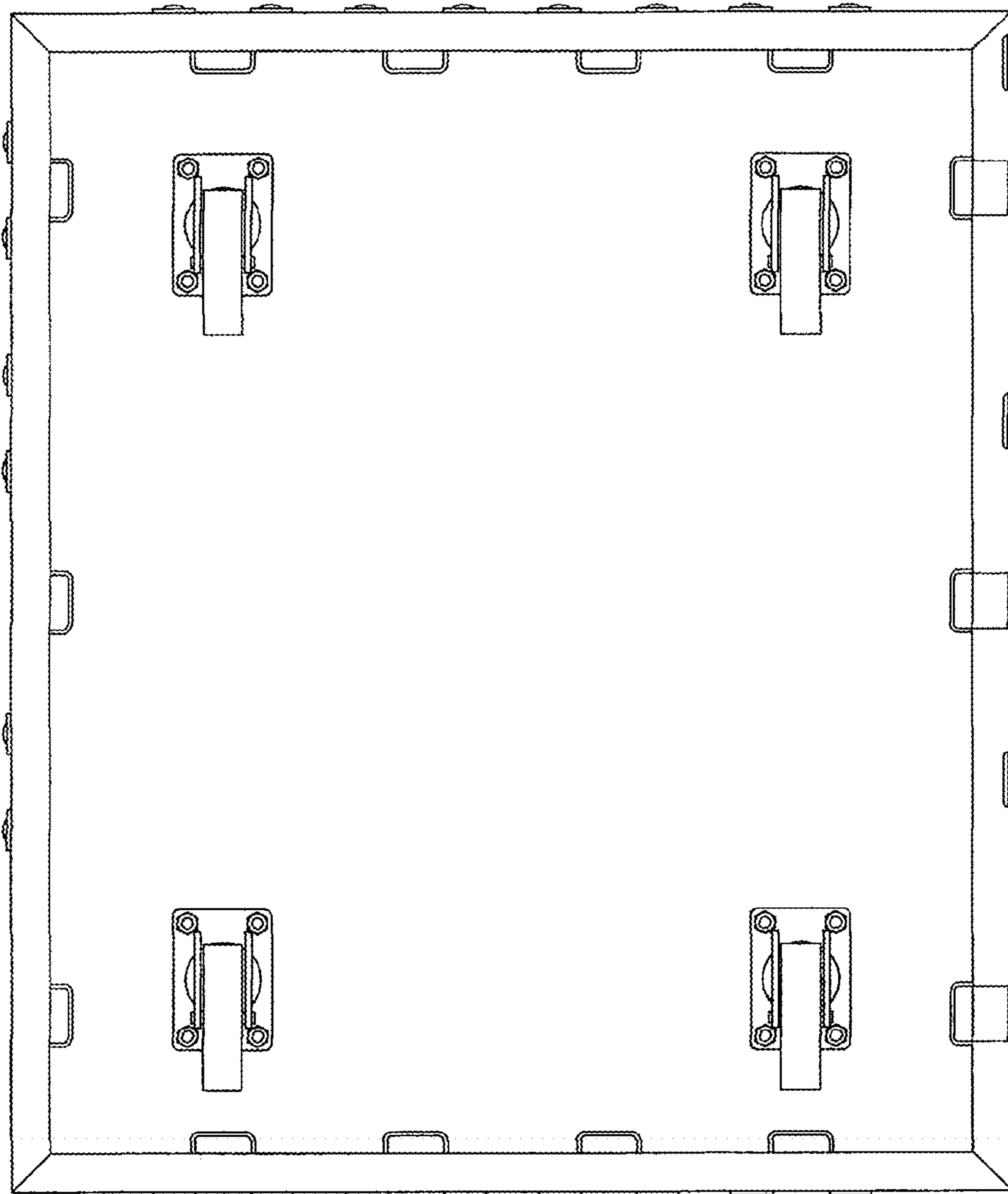

FIG. 4

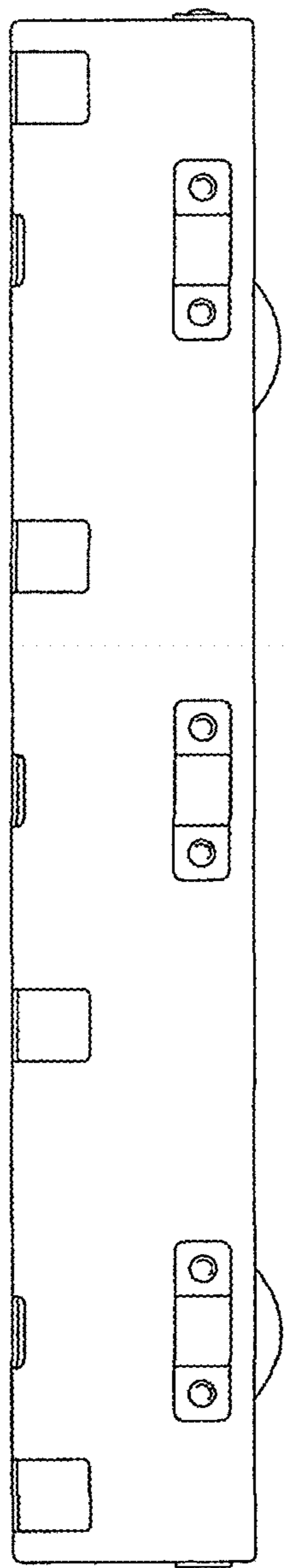

FIG. 5

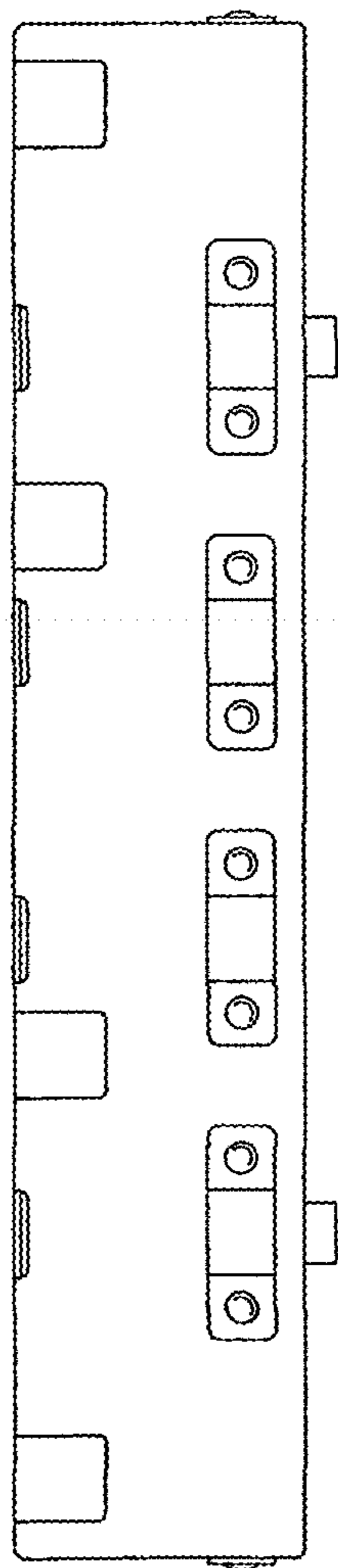

FIG. 6