



US00D744705S

(12) **United States Design Patent**
Fjellman

(10) **Patent No.:** **US D744,705 S**

(45) **Date of Patent:** **** Dec. 1, 2015**

(54) **VACUUM CLEANER**

(71) Applicant: **Aktiebolaget Electrolux**, Stockholm (SE)

(72) Inventor: **Oskar Fjellman**, Stockholm (SE)

(73) Assignee: **Aktiebolaget Electrolux**, Stockholm (SE)

(**) Term: **14 Years**

(21) Appl. No.: **29/482,798**

(22) Filed: **Feb. 21, 2014**

(30) **Foreign Application Priority Data**

Oct. 24, 2013 (EM) 001394092

(51) **LOC (10) Cl.** **15-05**

(52) **U.S. Cl.**
USPC **D32/21**

(58) **Field of Classification Search**
USPC D32/19-21, 25, 31-33; D4/102, 127, D4/128, 133, 136
CPC A47J 37/0713; A47L 9/2842; A47L 2201/00; A47L 5/30; A47L 5/28; A47L 5/362; A47L 9/04; A46B 13/005; A46B 13/001; A61C 17/26; G06N 3/008; B25J 9/1697; G01S 13/931; B62D 58/032; B62D 57/032; E01H 1/053; E01H 1/02
See application file for complete search history.

(56) **References Cited**

U.S. PATENT DOCUMENTS

D527,854 S *	9/2006	Marzynski	D32/21
D548,411 S *	8/2007	Schroter	D32/21
D659,920 S *	5/2012	Lee et al.	D32/21
D703,397 S *	4/2014	Sungkyung et al.	D32/21
D704,400 S *	5/2014	Shin et al.	D32/21
D709,255 S *	7/2014	Wang et al.	D32/21
D715,504 S *	10/2014	Deoksang et al.	D32/21
D720,103 S *	12/2014	Haug et al.	D32/21
D720,511 S *	12/2014	Shin et al.	D32/21
2009/0126143 A1 *	5/2009	Haegermarck	15/319

* cited by examiner

Primary Examiner — Ruth McInroy

(74) *Attorney, Agent, or Firm* — Banner & Witcoff, Ltd.

(57) **CLAIM**

The ornamental design for a vacuum cleaner, as shown and described.

DESCRIPTION

FIG. 1 is a front perspective view of a vacuum cleaner showing my new design;
FIG. 2 is a top plan view thereof;
FIG. 3 is a front view thereof;
FIG. 4 is a right side view thereof;
FIG. 5 is a left side view thereof; and,
FIG. 6 is a rear view thereof.

The broken line showing of the bottom regions of the vacuum cleaner is for environmental purposes only and form no part of the claimed design.

1 Claim, 6 Drawing Sheets

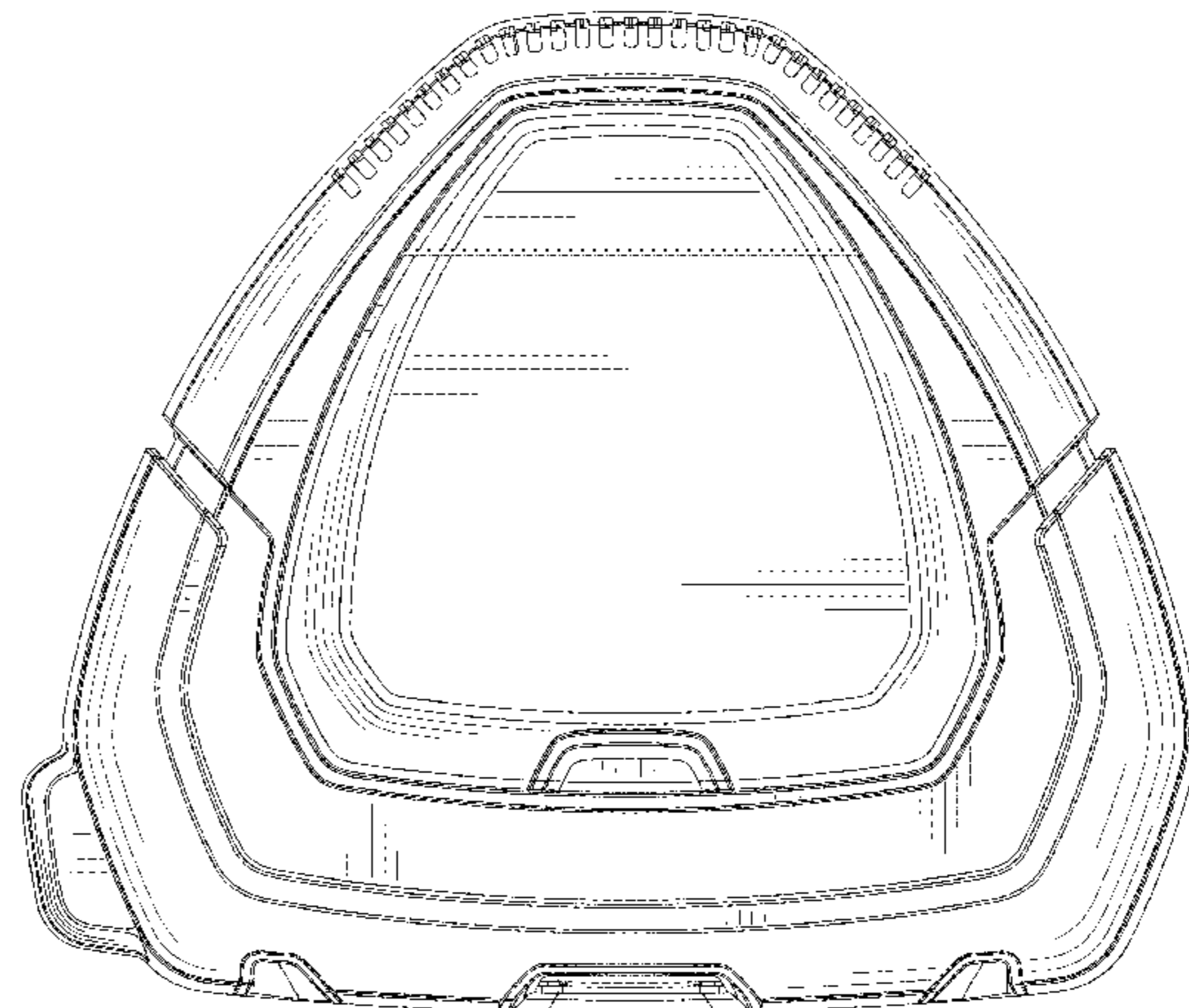
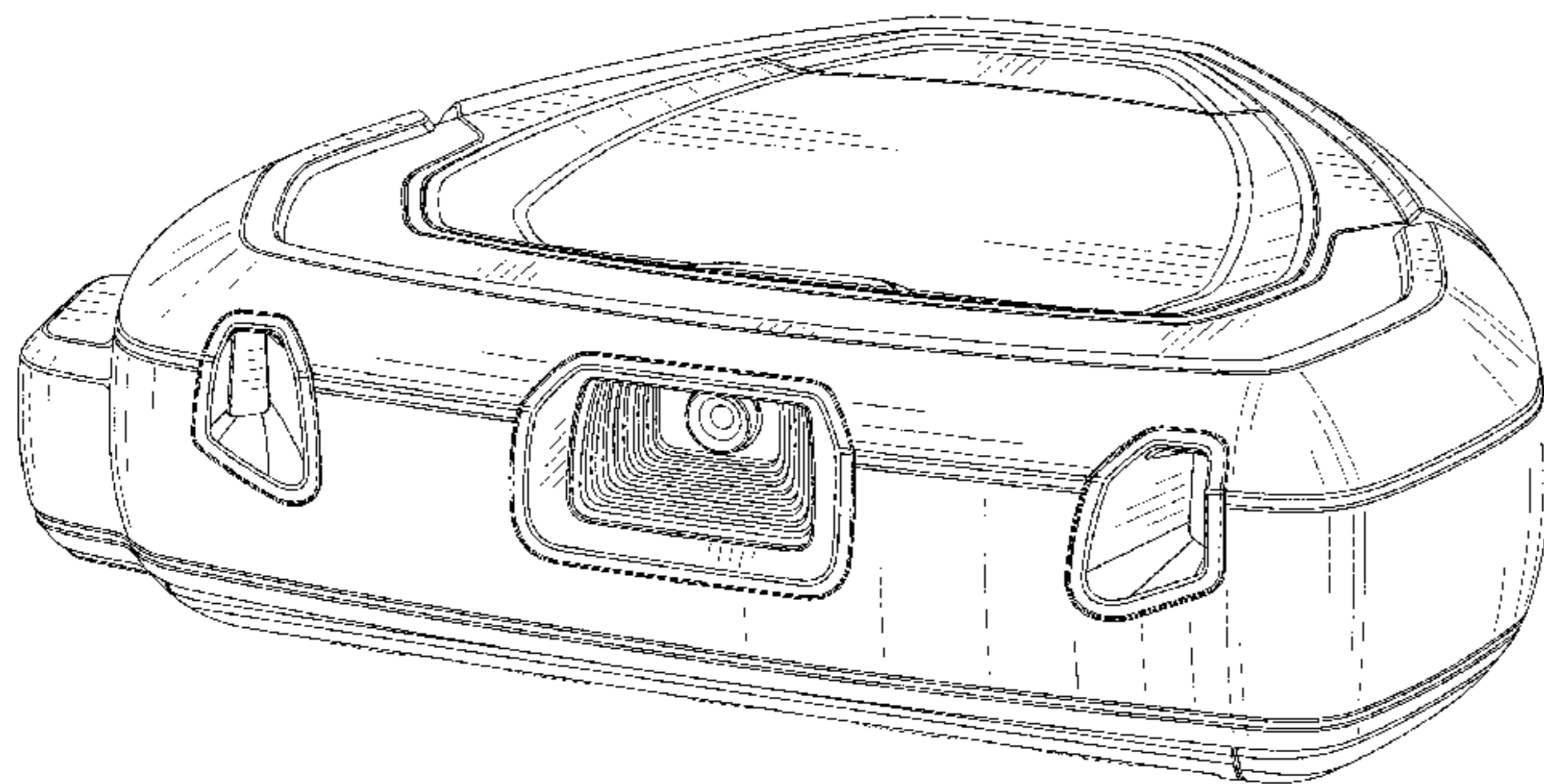

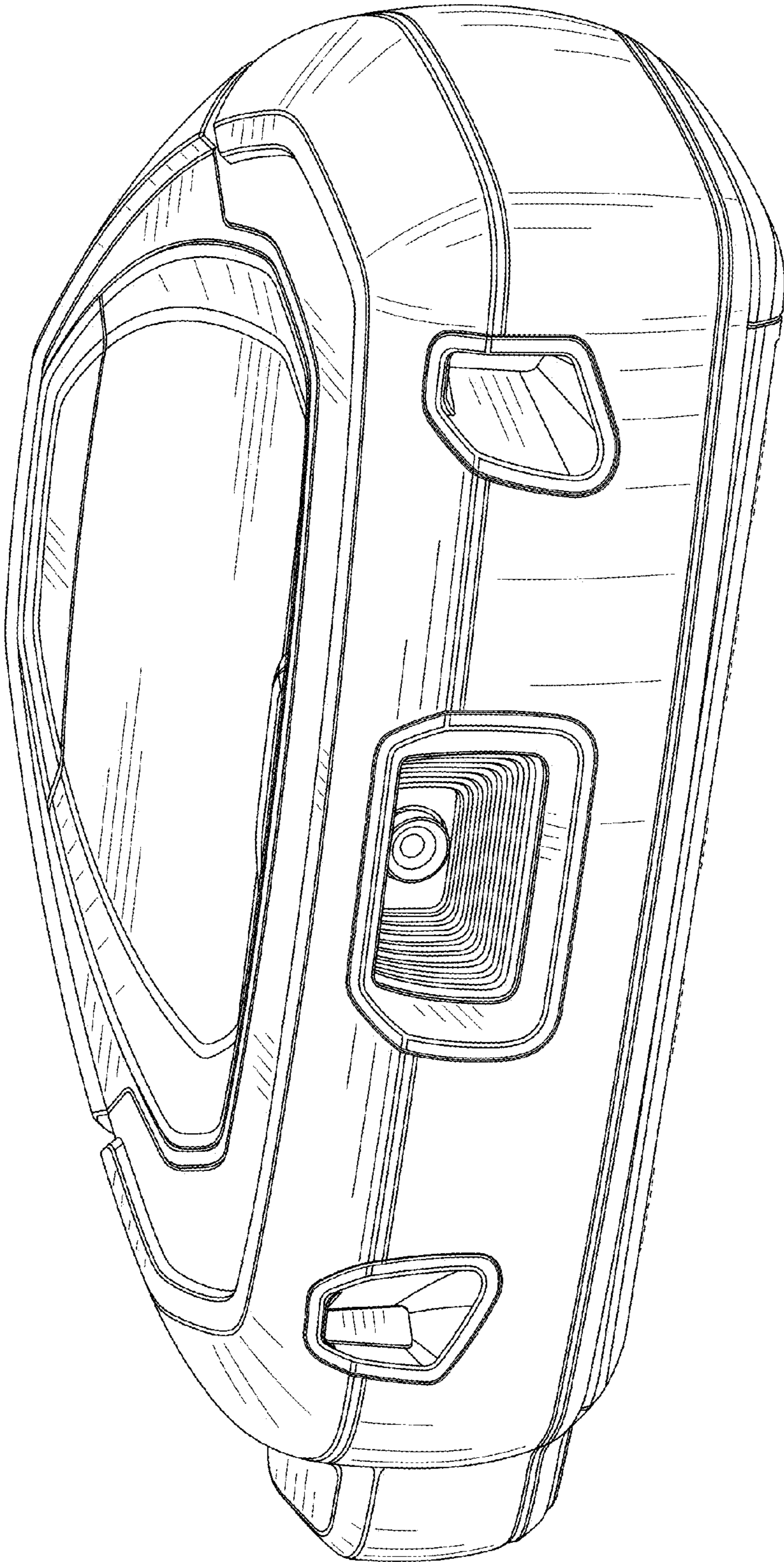

FIG. 1

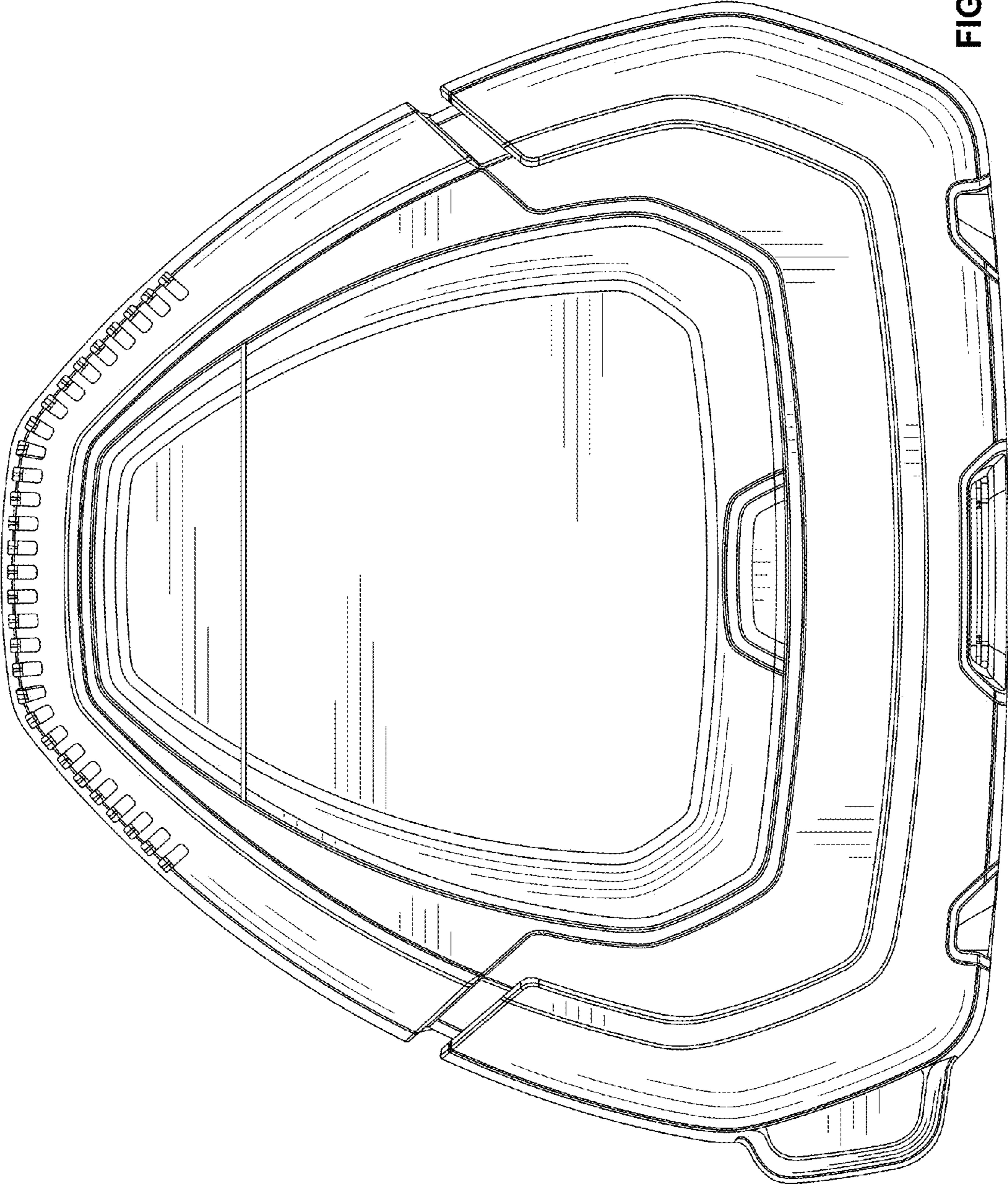

FIG. 2

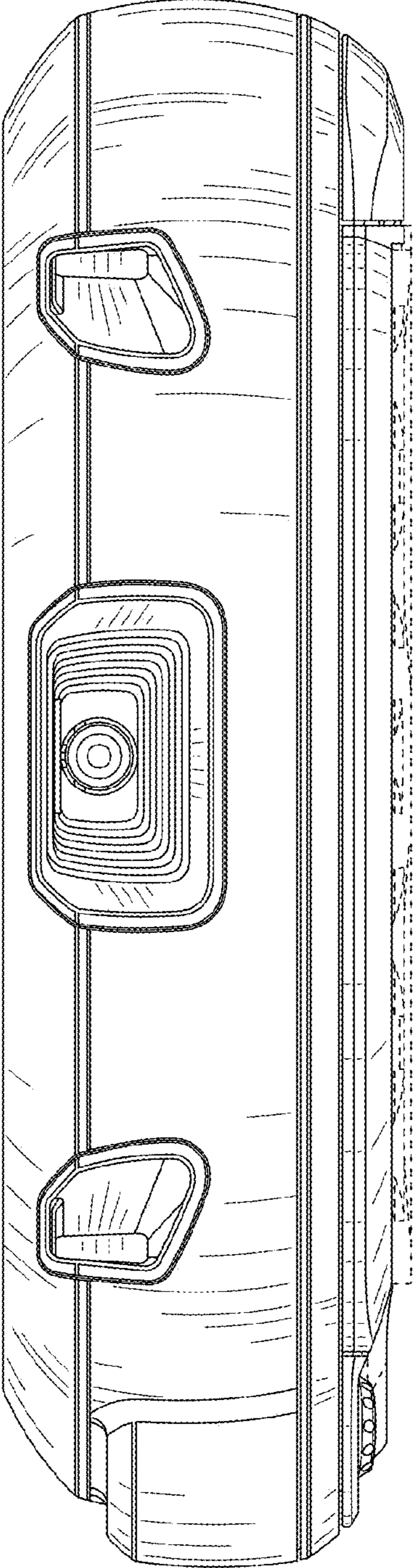

FIG. 3

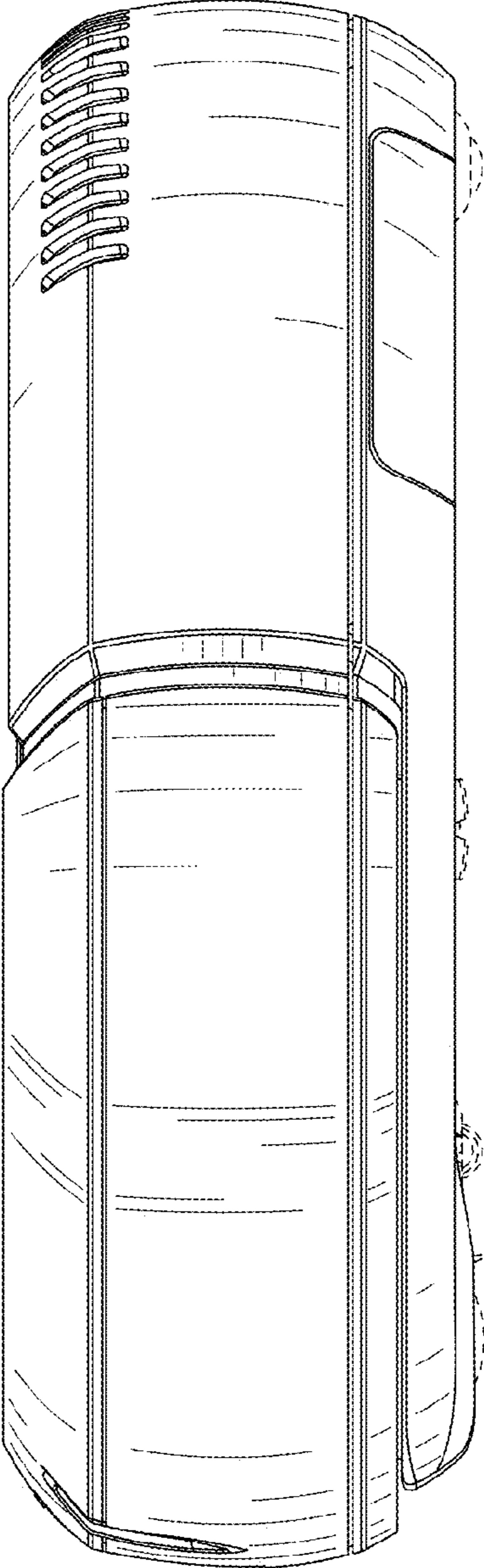

FIG. 4

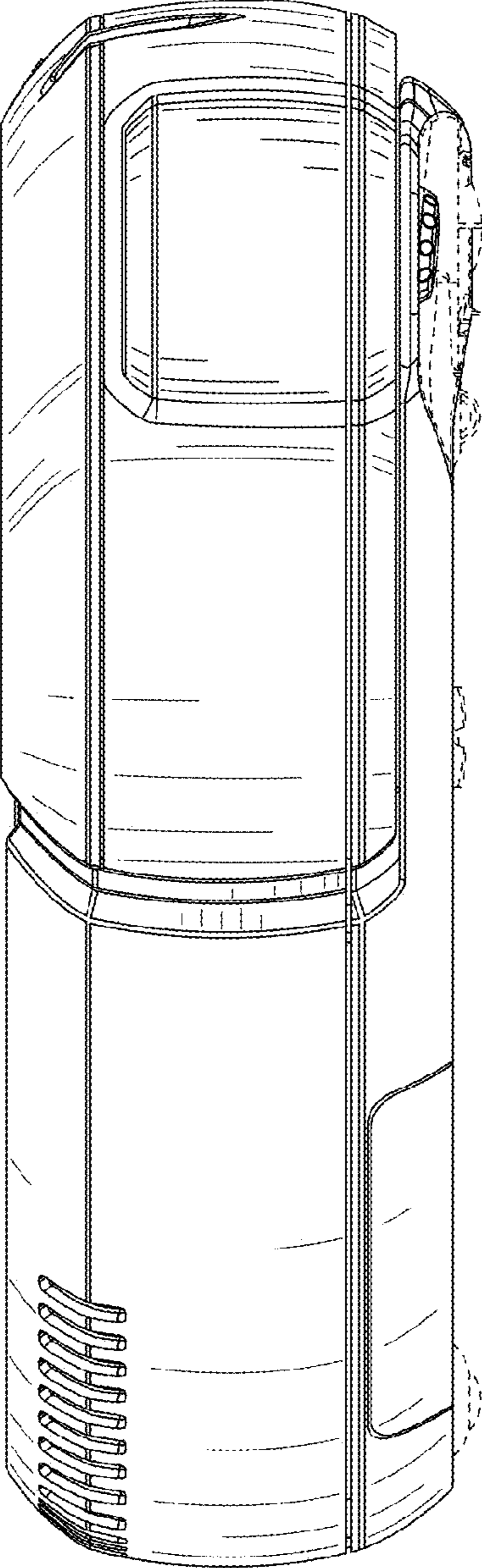

FIG. 5

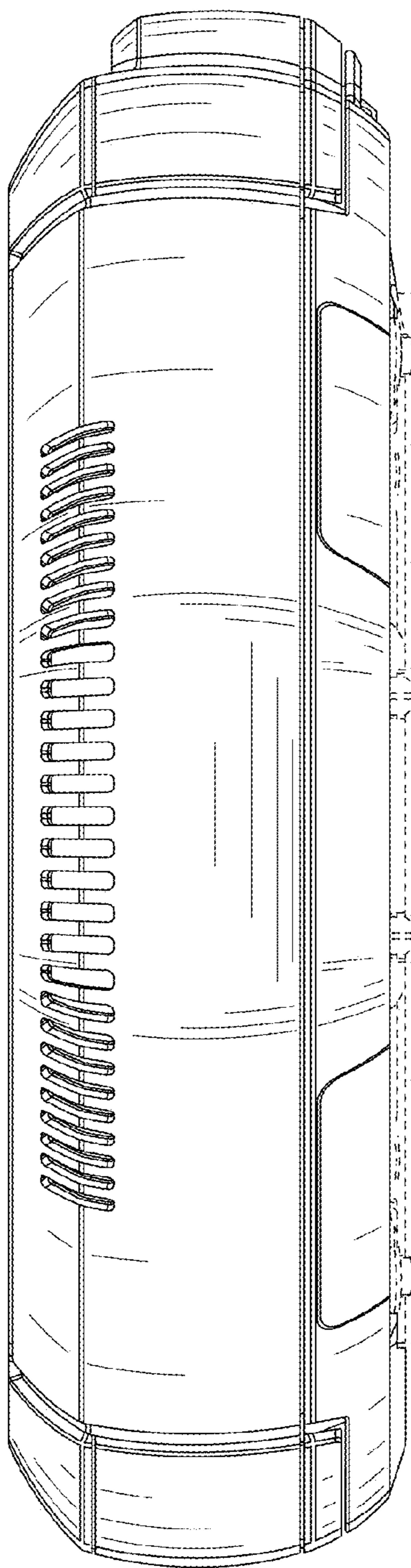

FIG. 6