



US00D744658S

(12) **United States Design Patent**
Hilkey-Boyatt

(10) **Patent No.:** **US D744,658 S**

(45) **Date of Patent:** **** Dec. 1, 2015**

(54) **MOOD MONITORING DEVICE**

(71) Applicant: **Katherine Hilkey-Boyatt**, Durham, NC
(US)

(72) Inventor: **Katherine Hilkey-Boyatt**, Durham, NC
(US)

(**) Term: **14 Years**

(21) Appl. No.: **29/513,009**

(22) Filed: **Dec. 24, 2014**

(51) **LOC (10) Cl.** **24-01**

(52) **U.S. Cl.**

USPC **D24/186**; D11/86

(58) **Field of Classification Search**

USPC D24/167, 186; D11/3, 86; D10/30-39,
D10/65, 70, 78, 97, 98, 103; D13/173-177;
D14/203.5, 247, 338-340, 344, 346,
D14/347

CPC G08G 1/096883; G08G 1/096872;
G08G 1/096775; G01C 21/16; G01C 21/3688;
G01C 21/30; G01V 8/20; G01J 5/023; G01J
5/24; A61B 5/4824; A61B 5/483

See application file for complete search history.

(56) **References Cited**

U.S. PATENT DOCUMENTS

D517,941 S * 3/2006 Stern D11/86
D517,942 S * 3/2006 Stern D11/86
D518,406 S * 4/2006 Stern D11/86
D613,411 S * 4/2010 Collins D24/186

D627,883 S * 11/2010 Hayashi D24/138
D711,004 S * 8/2014 Chen D24/186
D725,784 S * 3/2015 Xia D24/186
D734,856 S * 7/2015 Weichert D24/186

* cited by examiner

Primary Examiner — Zenia Bennett

(57) **CLAIM**

The ornamental design for a mood monitoring device, as shown and described.

DESCRIPTION

FIG. 1 is a perspective view showing my new design;
FIG. 2 is a front elevation view;
FIG. 3 is a rear elevation view;
FIG. 4 is a top plan view;
FIG. 5 is a bottom plan view;
FIG. 6 is a right side elevation view;
FIG. 7 is a left side elevation view;
FIG. 8 is a front elevation view of a second embodiment;
FIG. 9 is a front elevation view of a third embodiment;
FIG. 10 is a front elevation view of a fourth embodiment;
FIG. 11 is a perspective view showing the embodiment in FIGS. 1-7 in use;
FIG. 12 is a perspective view showing the embodiment in FIGS. 1-7 in use; and,
FIG. 13 is a perspective view showing the embodiment in FIGS. 1-7 in use.

The broken lines in the drawing are for illustrative purposes only and form no part of the claimed design.

1 Claim, 13 Drawing Sheets

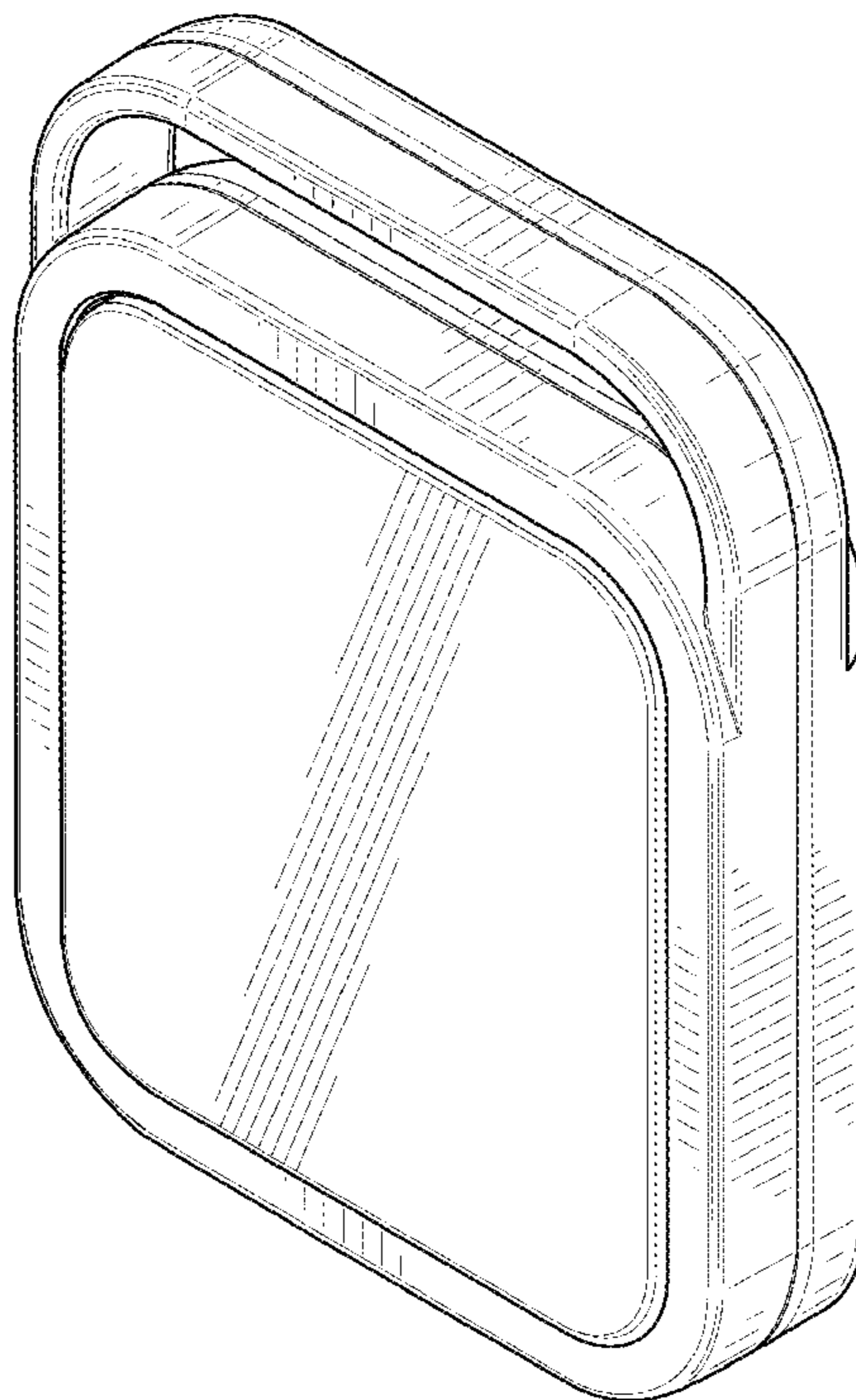

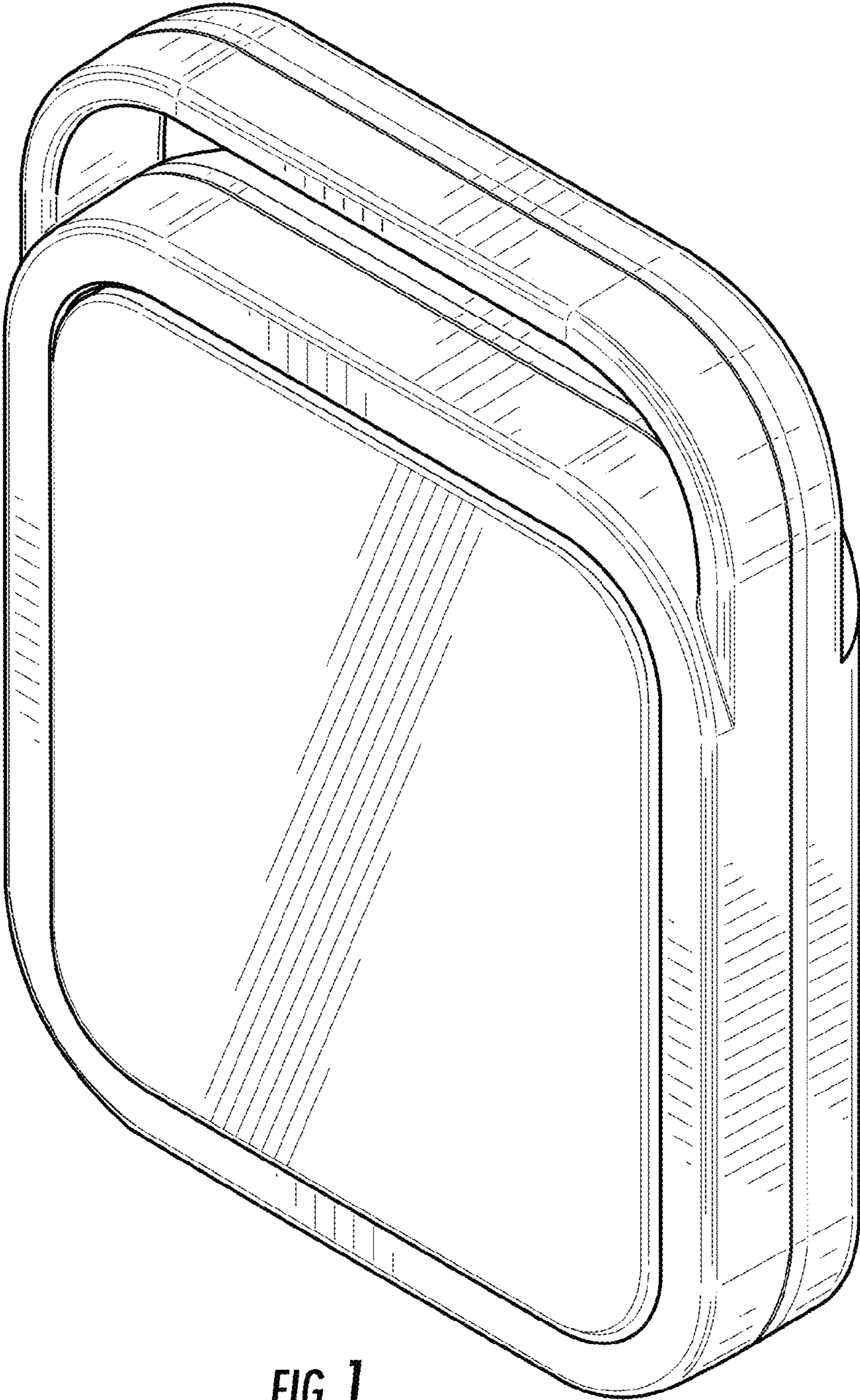

FIG. 1

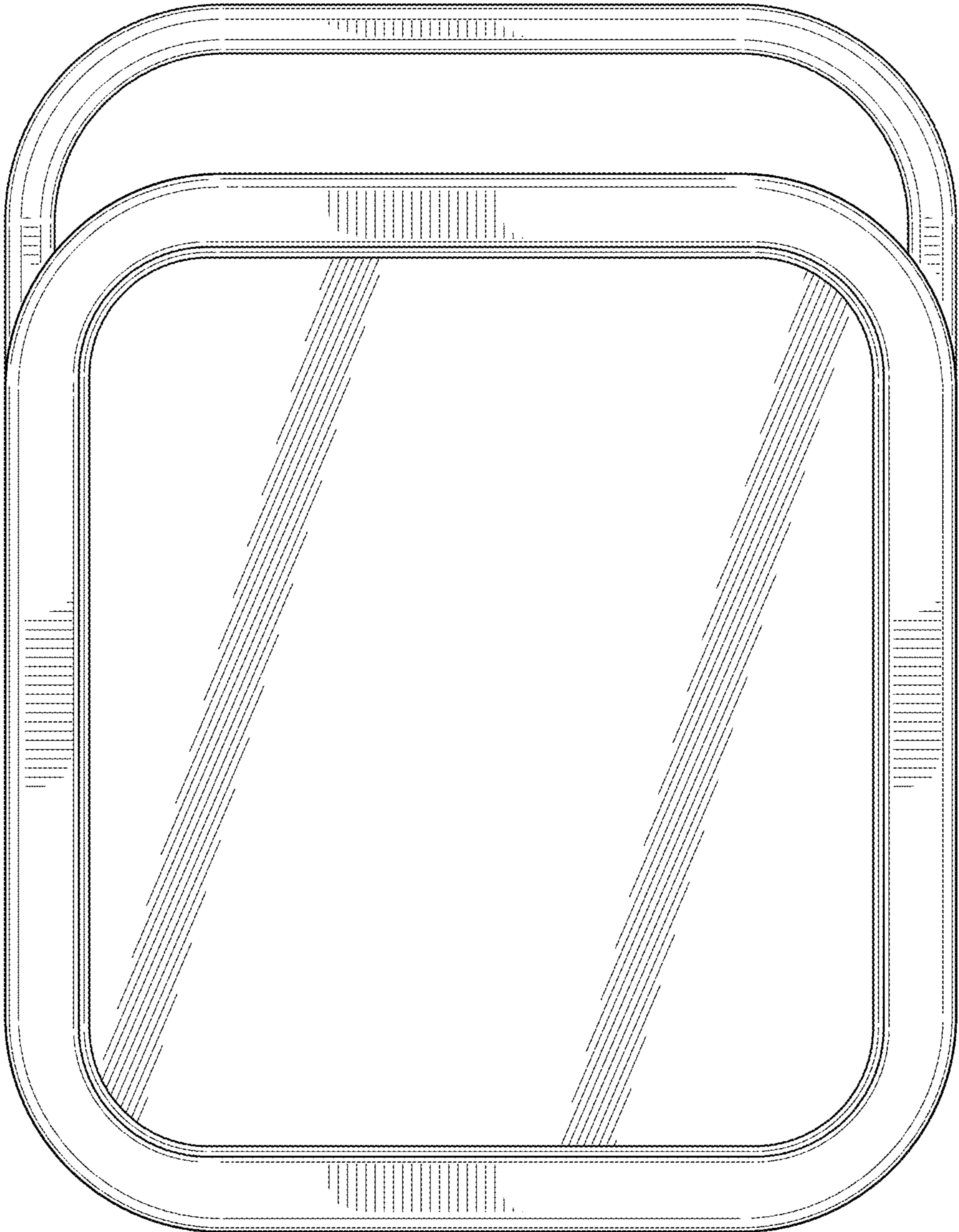

FIG. 2

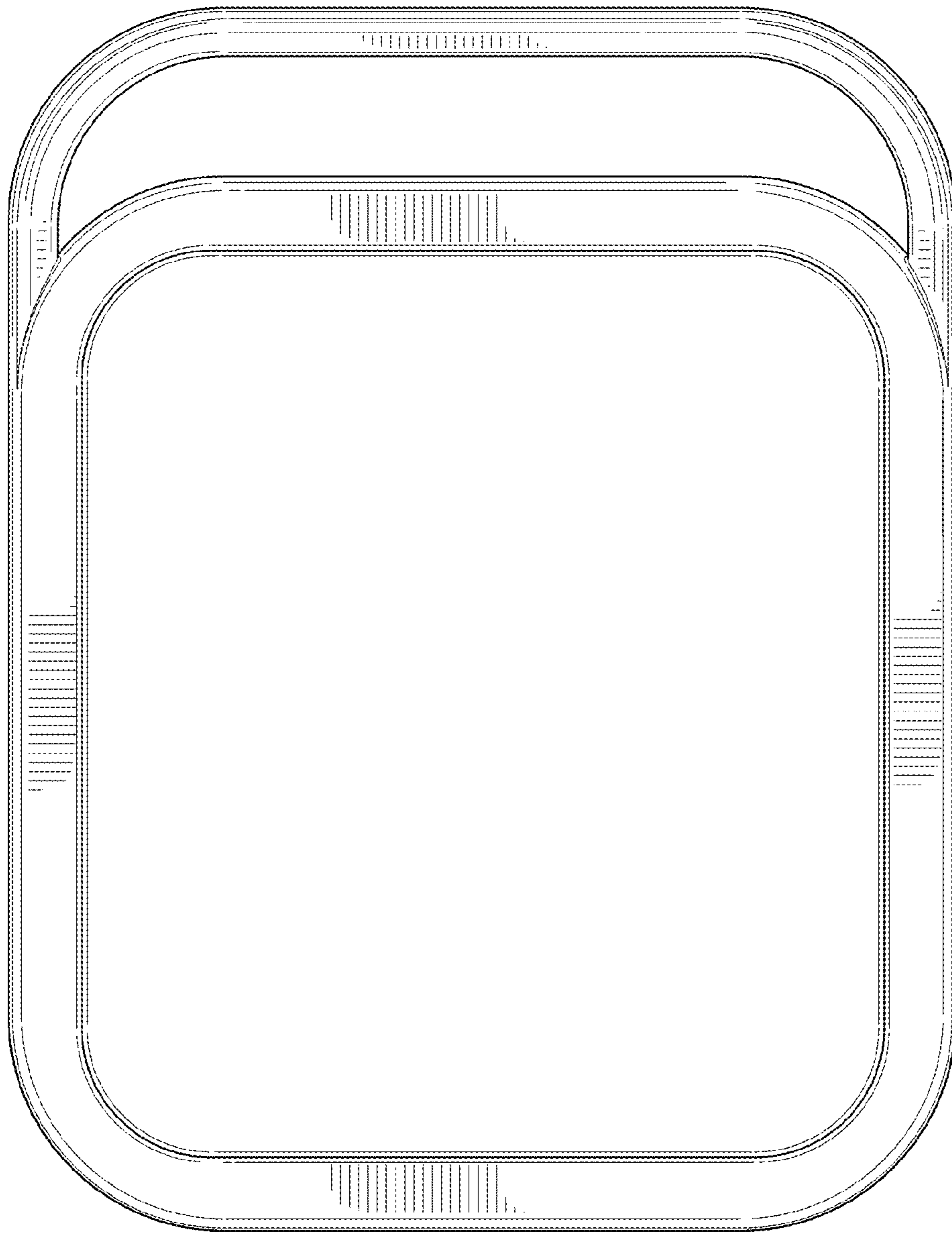

FIG. 3

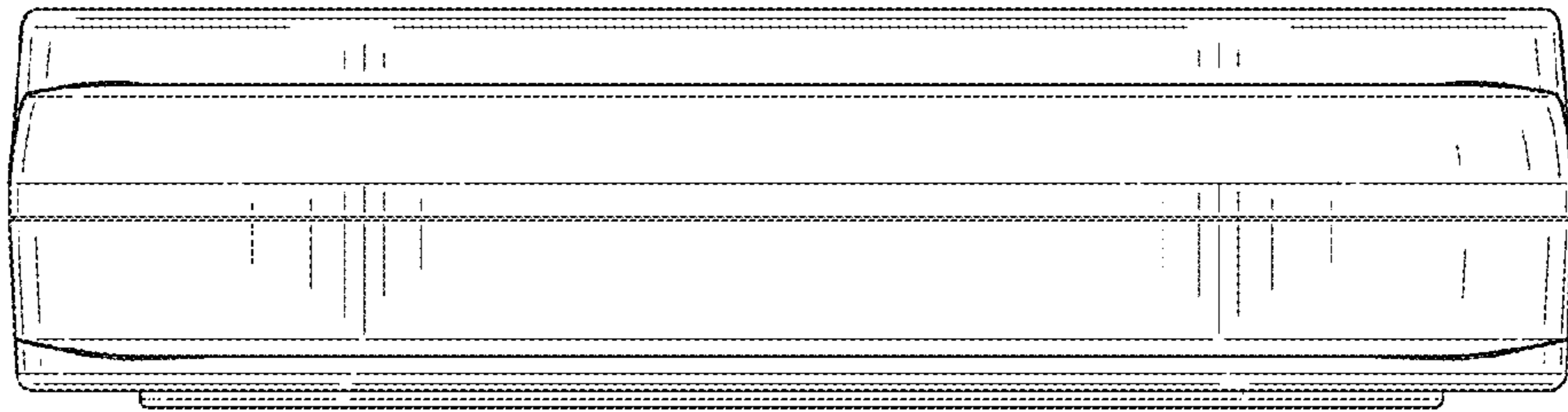

FIG. 4

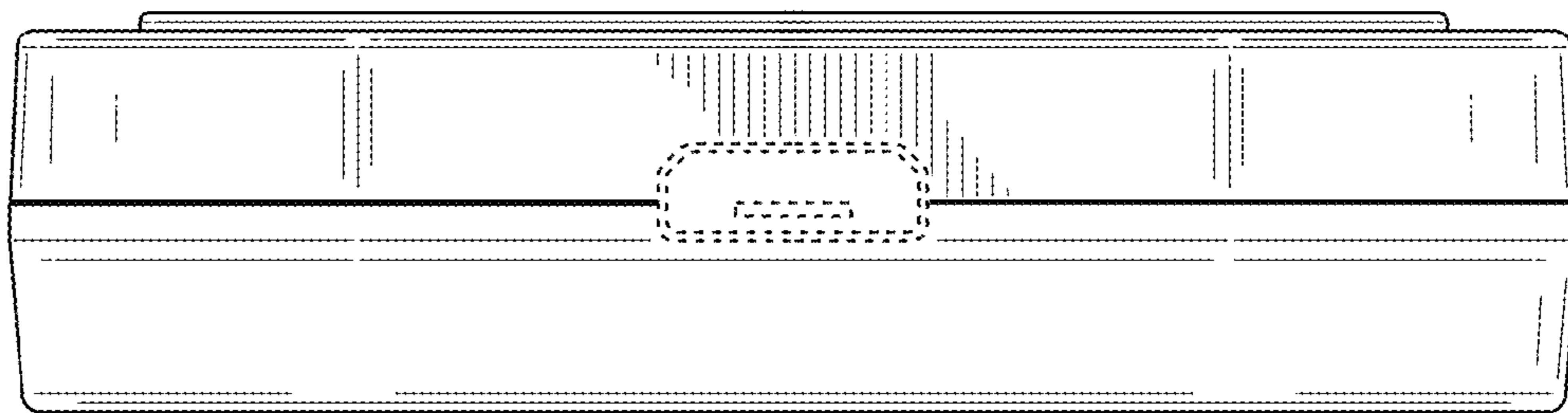

FIG. 5

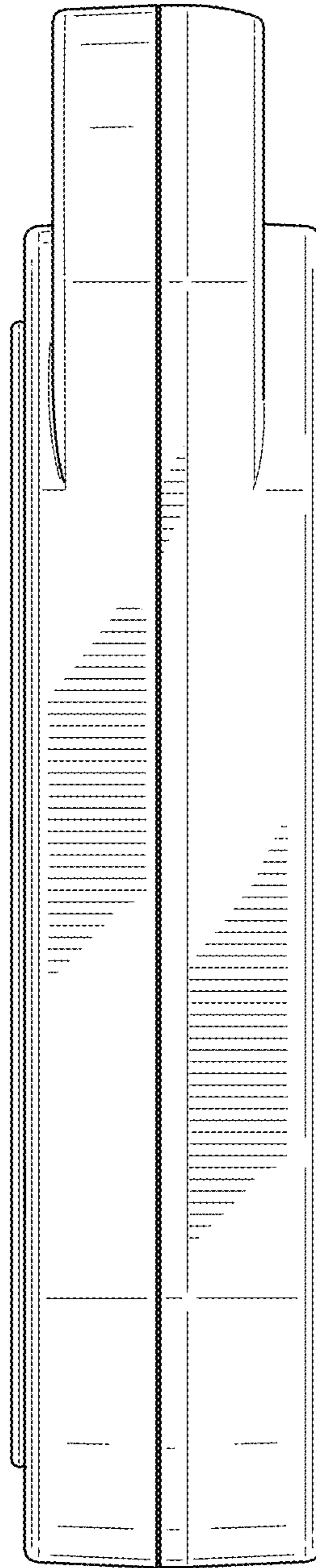

FIG. 6

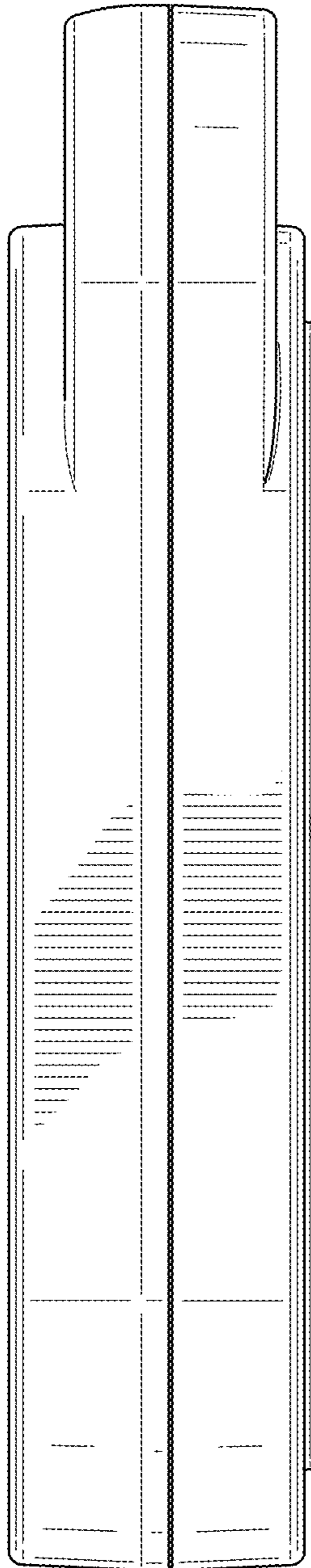

FIG. 7

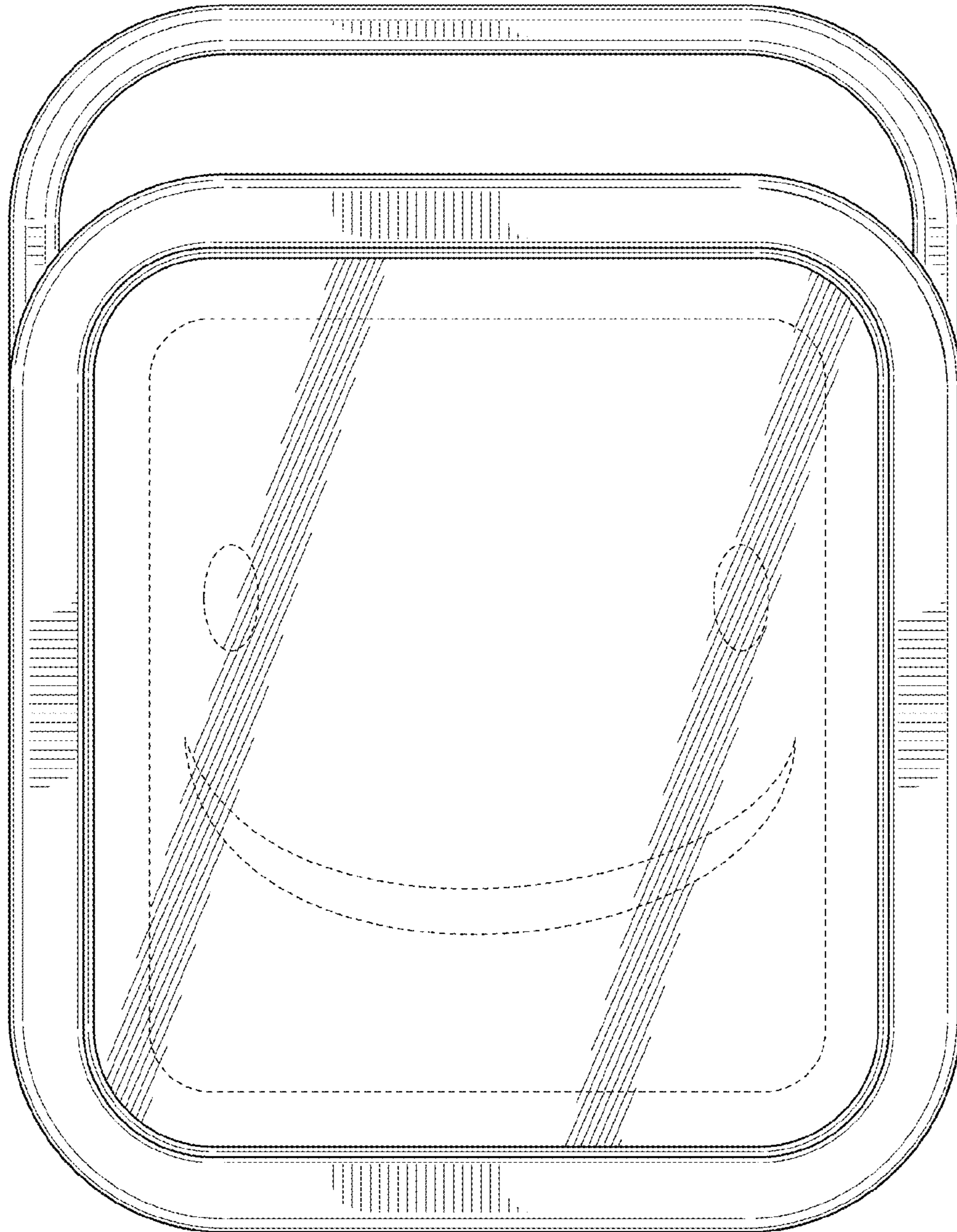

FIG. 8

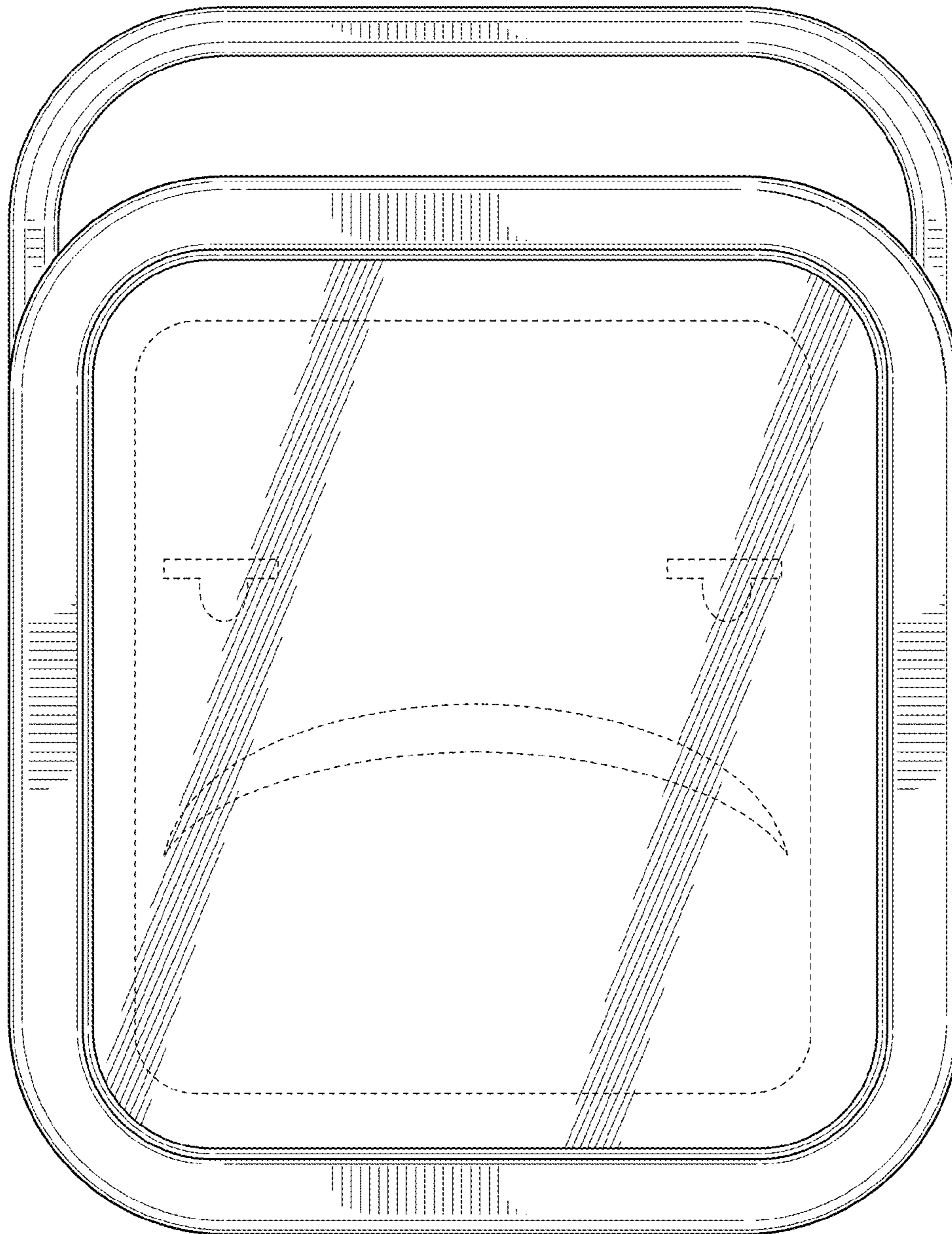

FIG. 9

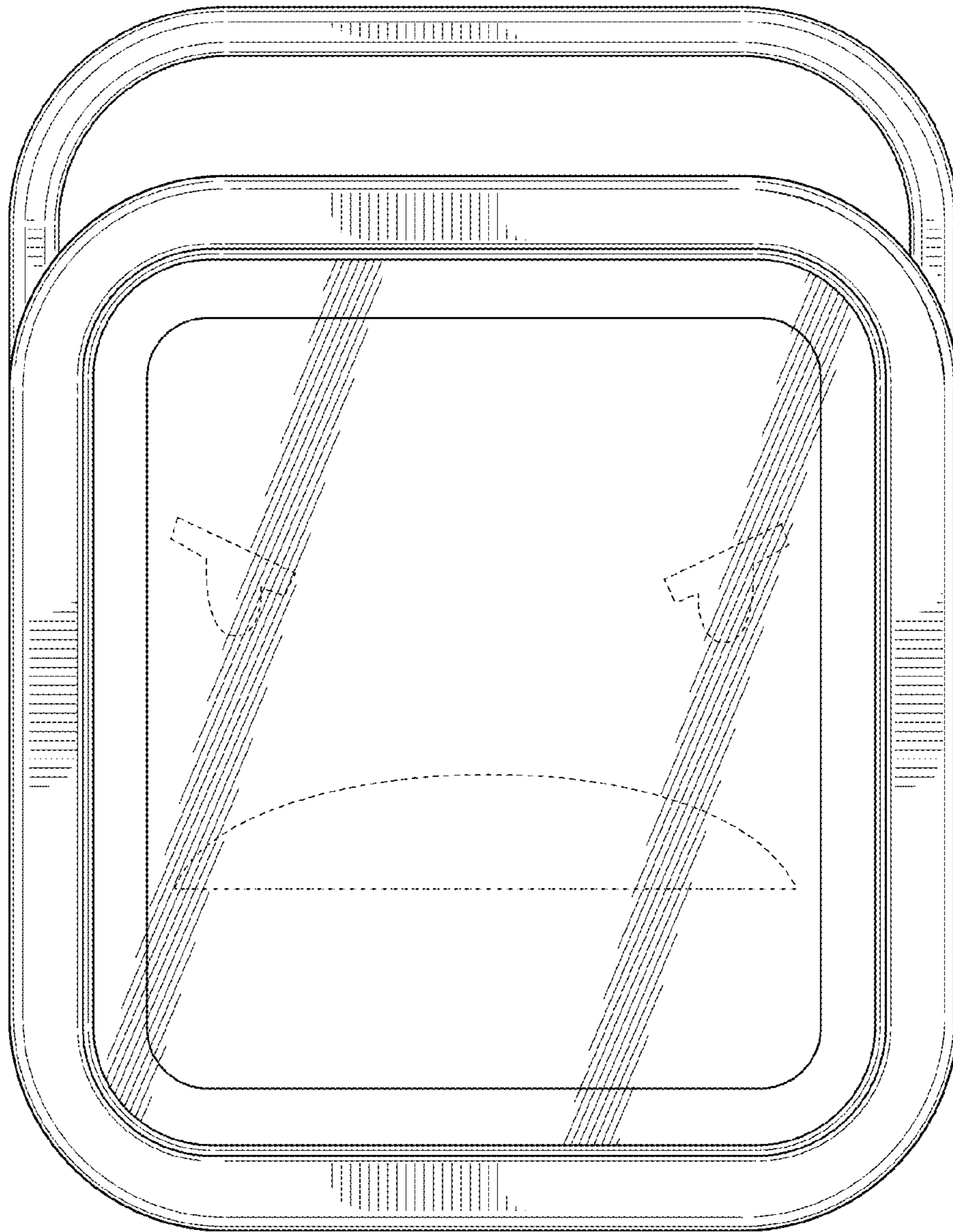

FIG. 10

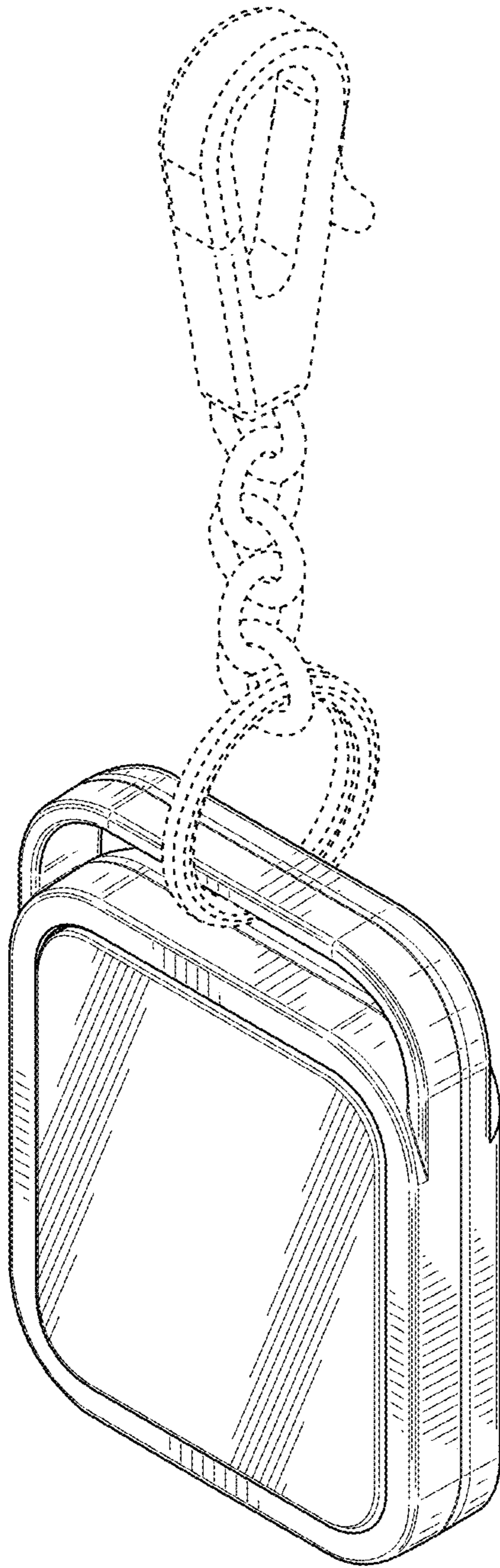

FIG. 11

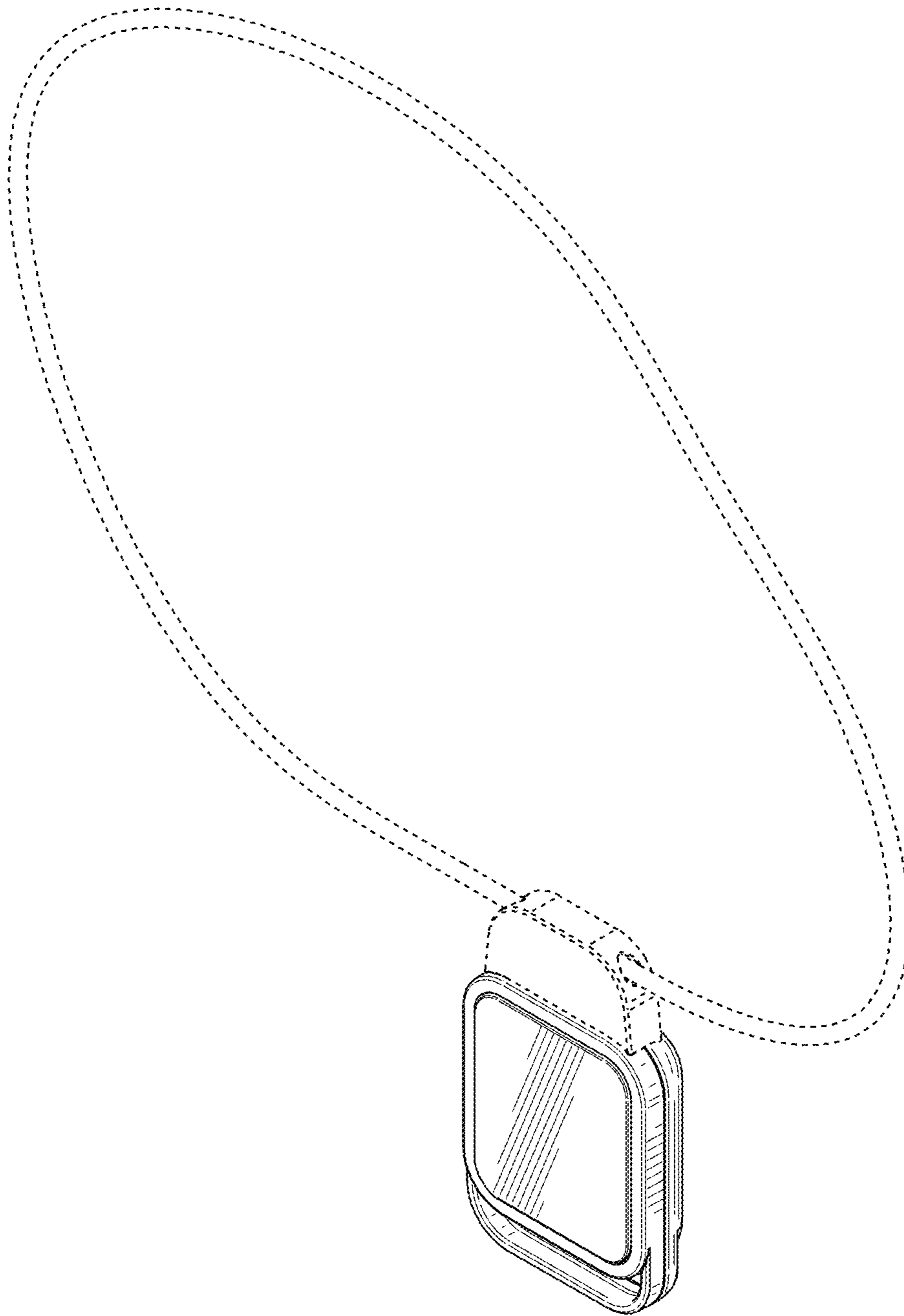

FIG. 12

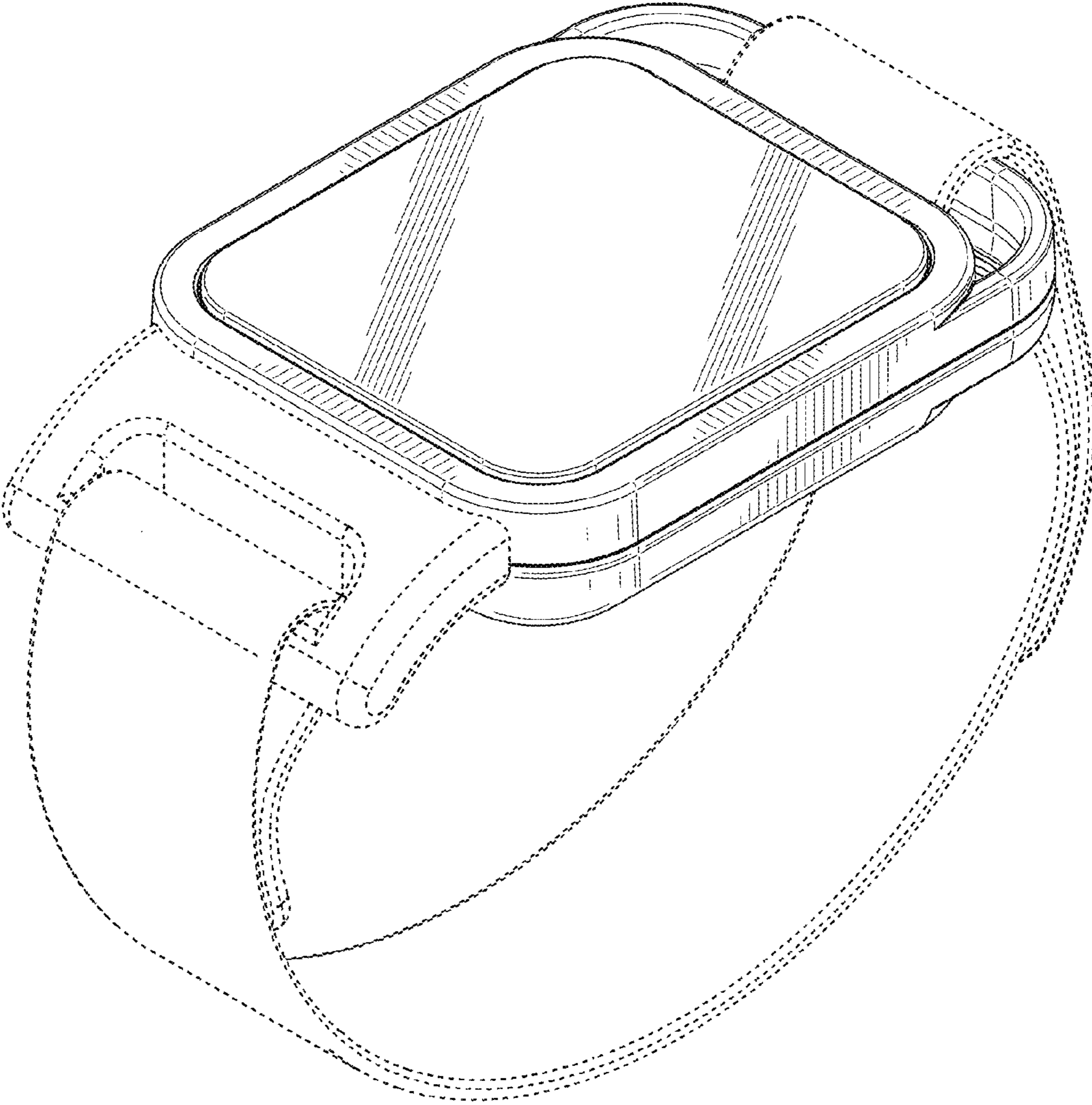

FIG. 13