



US00D744591S

(12) **United States Design Patent**  
**Puglisi et al.**

(10) **Patent No.:** **US D744,591 S**

(45) **Date of Patent:** **\*\* Dec. 1, 2015**

- (54) **CAP**
- (71) Applicants: **Marc Puglisi**, Wayne, NJ (US); **Kennis Kennis**, Montvale, NJ (US)
- (72) Inventors: **Marc Puglisi**, Wayne, NJ (US); **Kennis Kennis**, Montvale, NJ (US)

D303,631 S *	9/1989	Demarest	.....	D9/529
D310,542 S *	9/1990	Regnault	.....	D19/166
D341,227 S *	11/1993	Lang et al.	.....	D28/76
D470,888 S *	2/2003	Kuboshima	.....	D19/66
D482,726 S *	11/2003	Hung	.....	D19/166
D482,727 S *	11/2003	Hung	.....	D19/166
D572,755 S *	7/2008	Brigham et al.	.....	D19/121
D628,628 S *	12/2010	Hung	.....	D19/117
D632,574 S *	2/2011	Huntington et al.	.....	D9/504
D654,375 S *	2/2012	Kuboshima	.....	D9/724

(\*\*) Term: **14 Years**

\* cited by examiner

(21) Appl. No.: **29/498,968**

*Primary Examiner* — Elizabeth Albert

(22) Filed: **Aug. 10, 2014**

(74) *Attorney, Agent, or Firm* — Kaliko & Associates, LLC;  
Scott H. Kaliko, Esq.

(51) **LOC (10) Cl.** ..... **19-06**

(52) **U.S. Cl.**  
USPC ..... **D19/195**

(57) **CLAIM**

An ornamental design for a cap, as shown and described.

(58) **Field of Classification Search**  
USPC ..... D8/98, 99; D14/411; D19/115–204;  
D28/7  
CPC ..... B43K 5/005; B43K 7/00; B43K 7/01;  
B43K 7/10; B43K 7/12; B43K 19/00; B43K  
19/02; B43K 8/04  
See application file for complete search history.

**DESCRIPTION**

FIG. 1 is a perspective view of a cap showing our new design; FIG. 2 is a front elevation view thereof; FIG. 3 is a back elevation view thereof; FIG. 4 is a left side elevation view thereof; FIG. 5 is a right side elevation view thereof; FIG. 6 is a top plan view thereof; and, FIG. 7 is a bottom plan view thereof.

The broken line showing the inside in FIG. 7 is included for the purpose of showing a portion of the cap that forms no part of the claimed design.

(56) **References Cited**

U.S. PATENT DOCUMENTS

1,868,200 A *	7/1932	Freedman	.....	401/98
D137,706 S *	4/1944	Estes	.....	D19/53
D255,654 S *	7/1980	Goss	.....	D9/529
4,285,101 A *	8/1981	Hanna	.....	24/3.12
D292,672 S *	11/1987	Duell	.....	D4/114

**1 Claim, 2 Drawing Sheets**

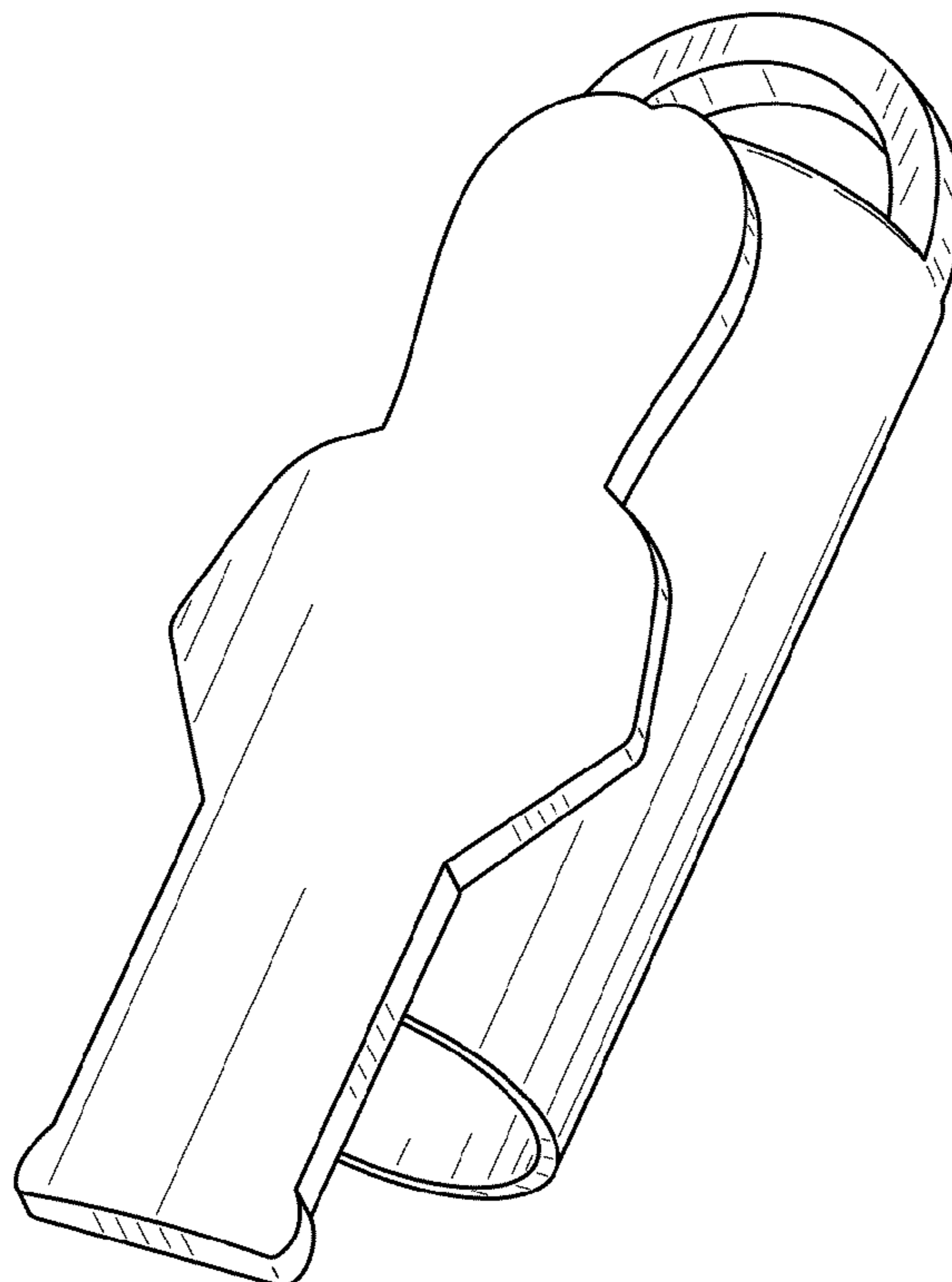

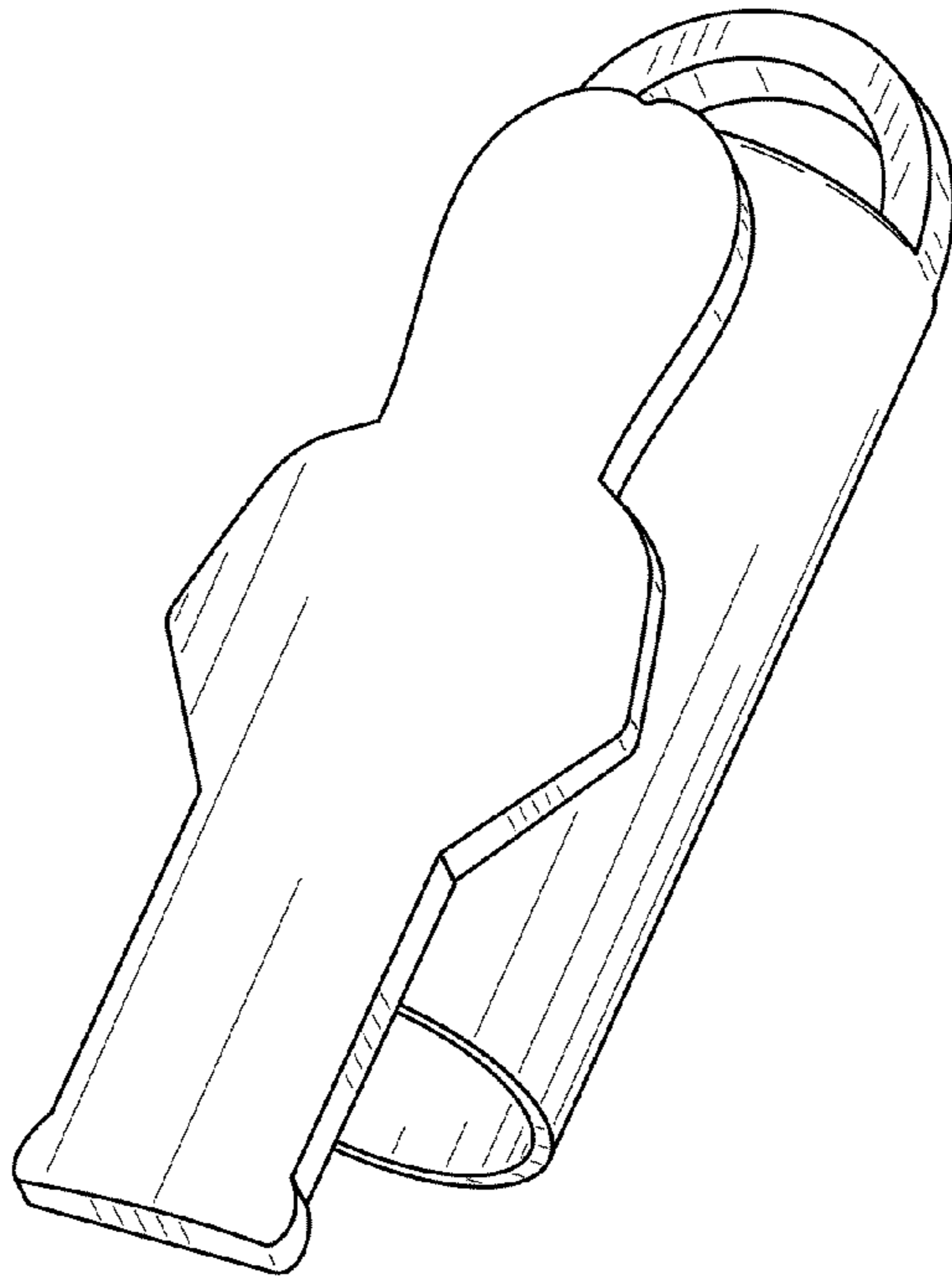

FIG. 1

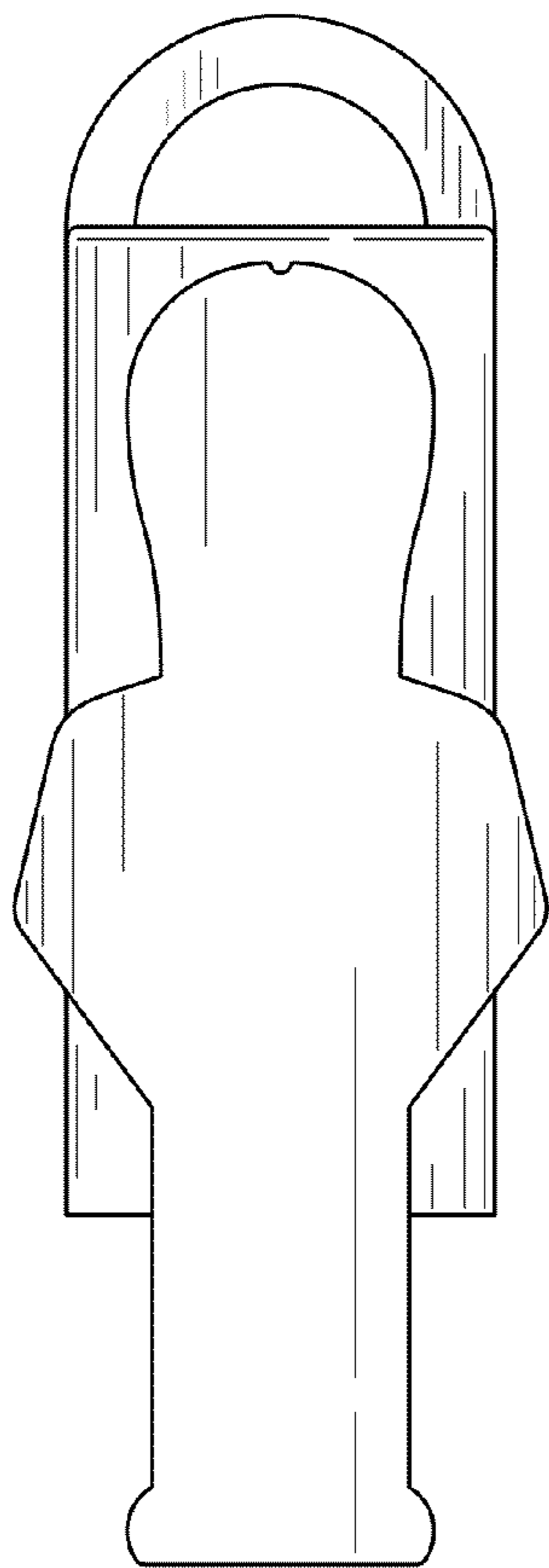

FIG. 2

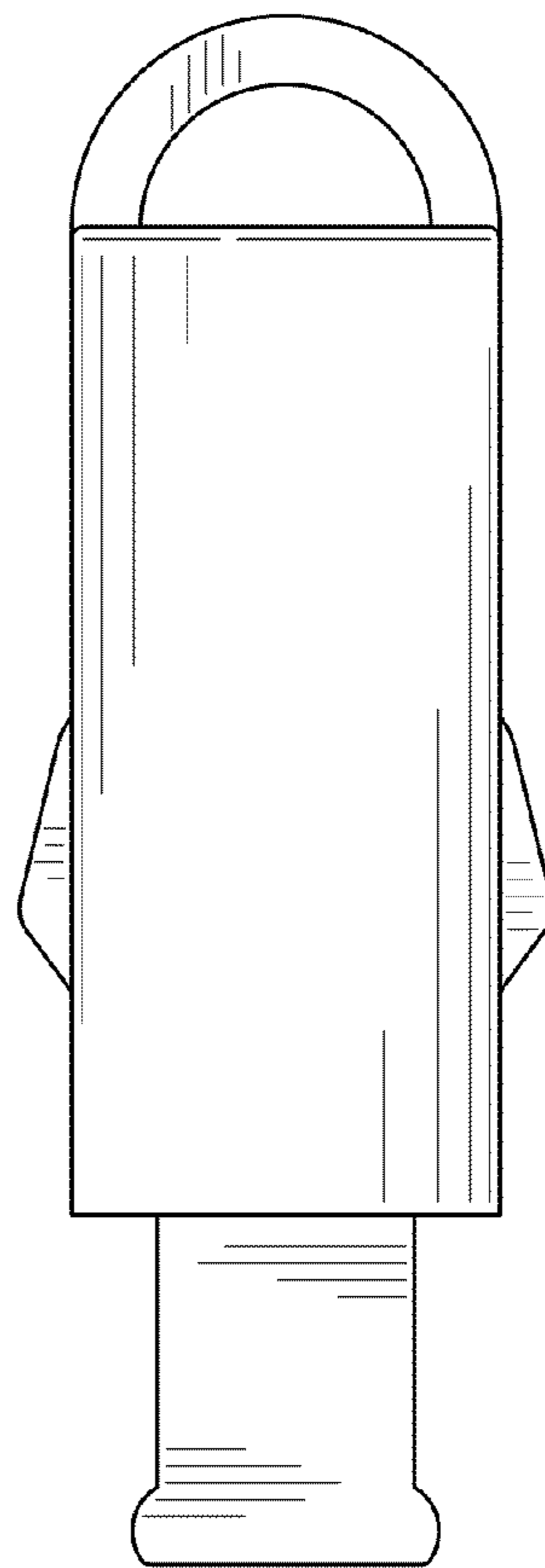

FIG. 3

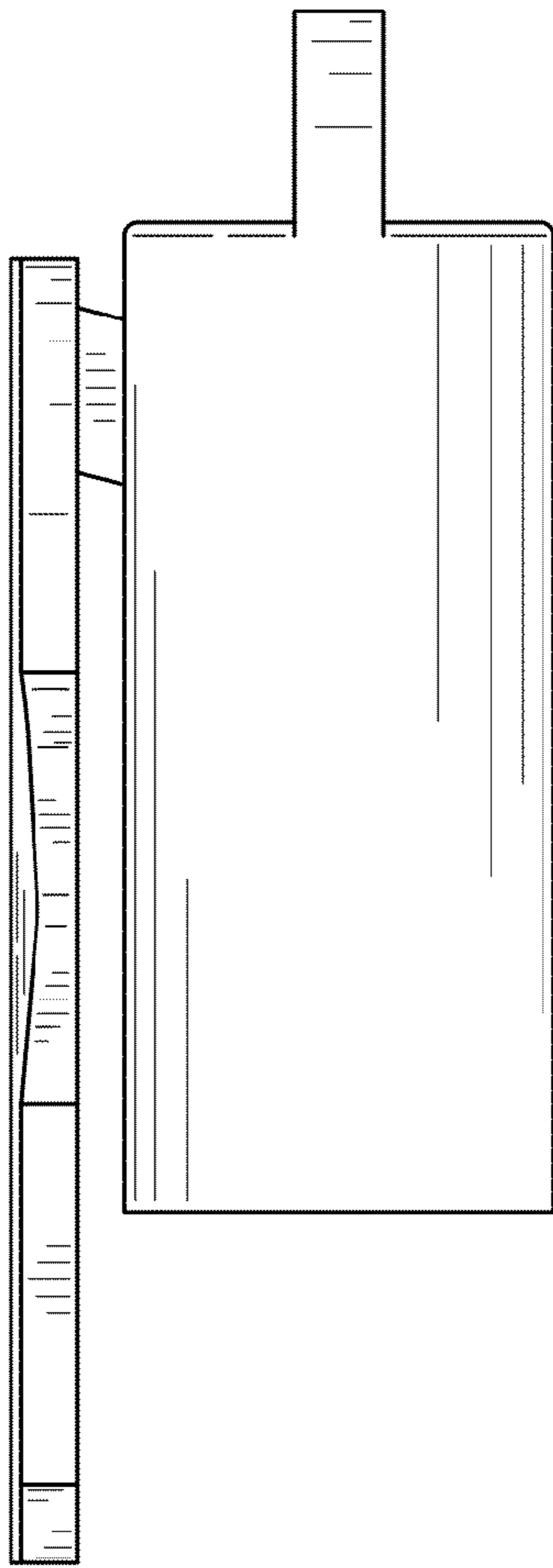

FIG. 4

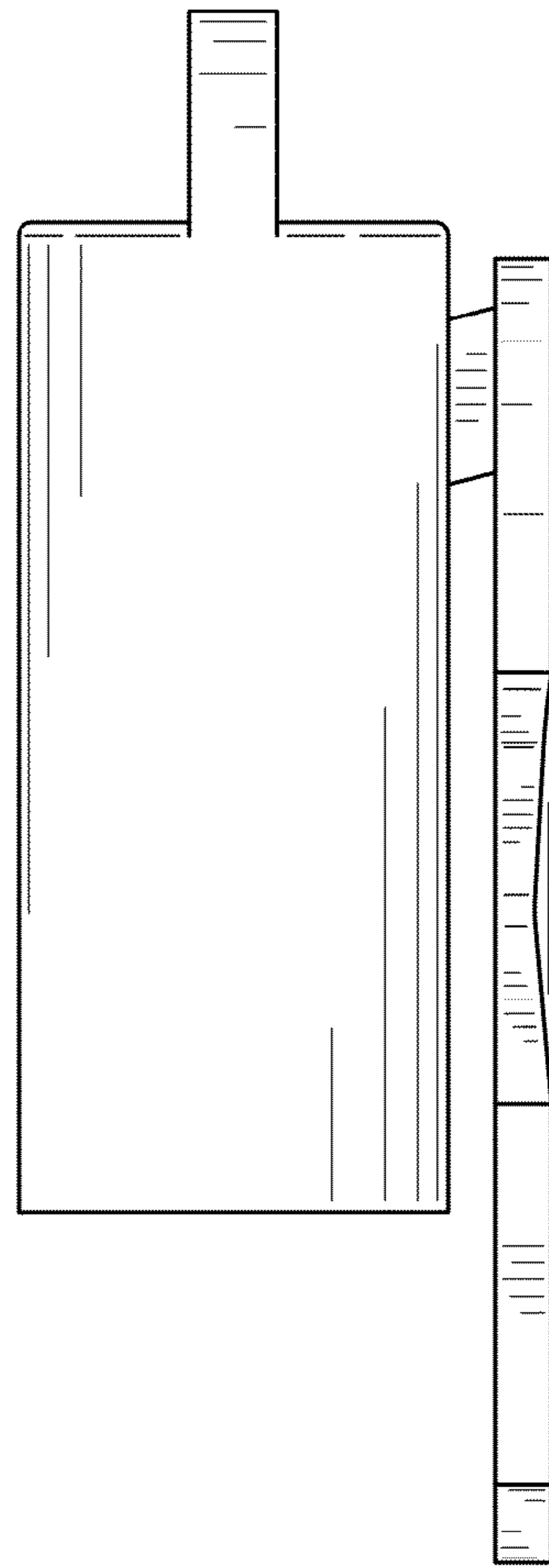

FIG. 5

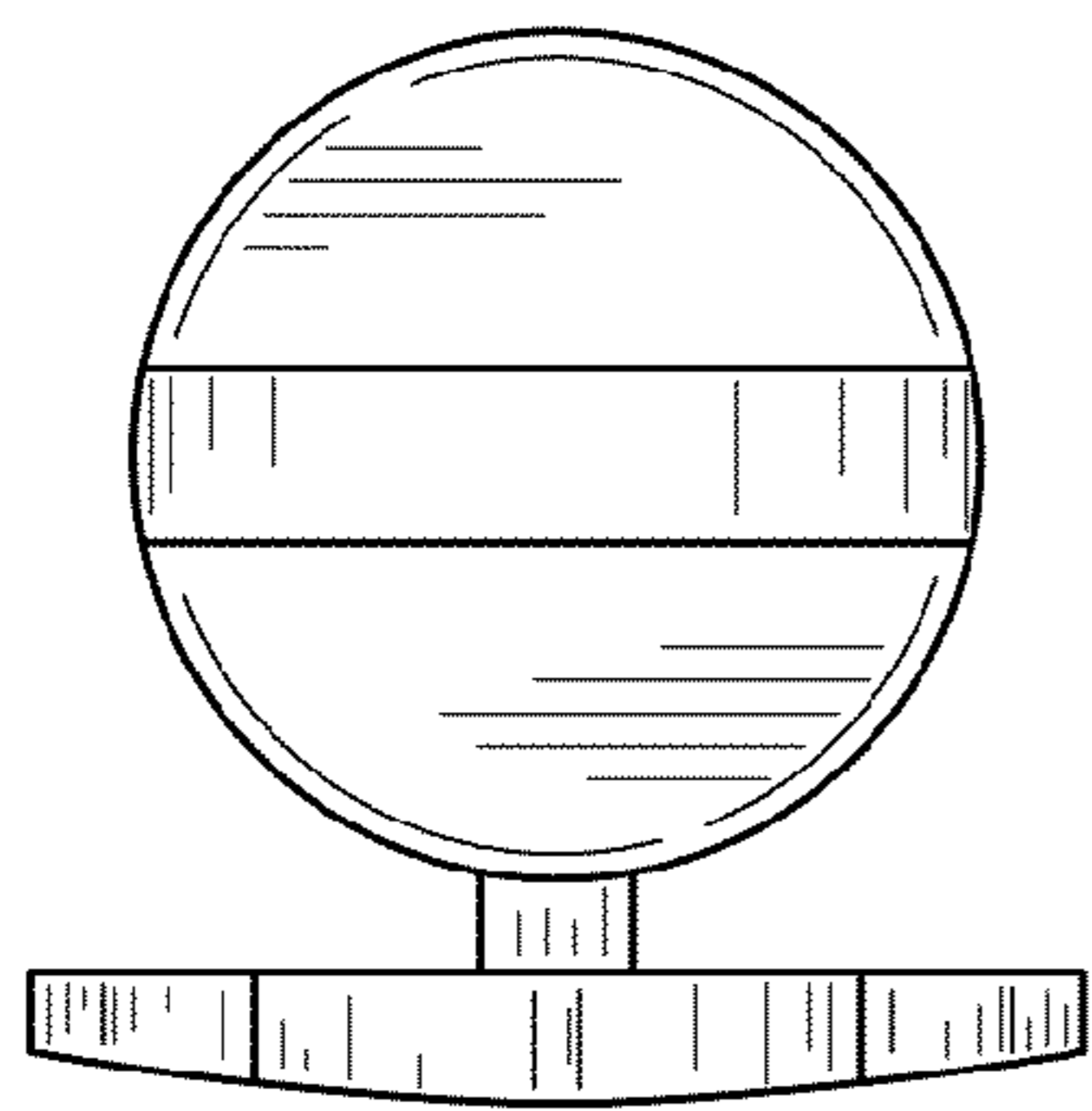

FIG. 6

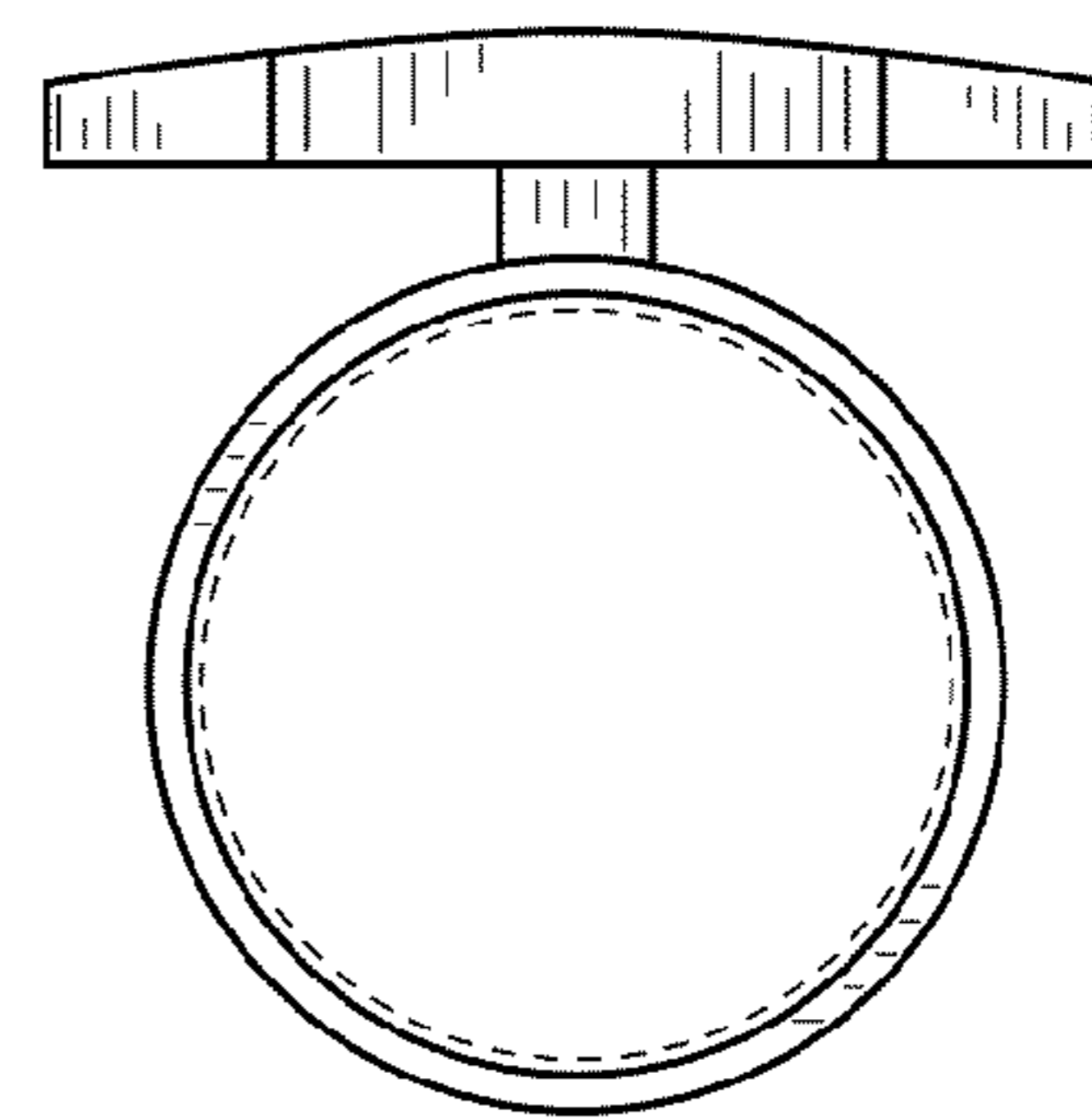

FIG. 7