



US00D744576S

(12) **United States Design Patent**
Masuda et al.

(10) **Patent No.:** **US D744,576 S**

(45) **Date of Patent:** **** Dec. 1, 2015**

(54) **PROJECTOR**

(71) Applicant: **Hitachi Maxell, Ltd.**, Osaka (JP)

(72) Inventors: **Ai Masuda**, Tokyo (JP); **Atsushi Ishibashi**, Tokyo (JP); **Toshiyuki Moriya**, Tokyo (JP); **Hiroyuki Inoue**, Osaka (JP); **Naoto Kubota**, Osaka (JP)

(73) Assignee: **HITACHI MAXELL, LTD.**, Osaka (JP)

(**) Term: **14 Years**

(21) Appl. No.: **29/495,971**

(22) Filed: **Jul. 8, 2014**

(30) **Foreign Application Priority Data**

Jan. 31, 2014 (JP) 2014-001934

(51) **LOC (10) Cl.** **16-02**

(52) **U.S. Cl.**
USPC **D16/230; D16/225**

(58) **Field of Classification Search**
USPC D16/221, 225, 230-231, 234; D21/514;
353/115, 119, 122
CPC G03B 21/00; G03B 21/145; G03B 17/54;
G03B 21/001
See application file for complete search history.

(56) **References Cited**

U.S. PATENT DOCUMENTS

D623,678 S * 9/2010 Nakayama et al. D16/225
D647,941 S * 11/2011 Yuyama D16/230

D663,760 S * 7/2012 Miyauchi et al. D16/230
D681,091 S * 4/2013 Morita et al. D16/230
8,454,174 B2 * 6/2013 Nakano et al. 353/119
D691,649 S * 10/2013 Takeda et al. D16/230
8,915,598 B2 * 12/2014 Koyama et al. 353/122
2011/0279787 A1 * 11/2011 Yoshimura et al. 353/57
2013/0128240 A1 * 5/2013 Yoshida et al. 353/121

* cited by examiner

Primary Examiner — Wan Laymon

(74) *Attorney, Agent, or Firm* — Baker Botts L.L.P.

(57) **CLAIM**

The ornamental design for a projector, as shown and described.

DESCRIPTION

FIG. 1 is a front perspective view of the projector showing our new design;

FIG. 2 is a rear perspective view thereof;

FIG. 3 is a front view thereof;

FIG. 4 is a right side view thereof;

FIG. 5 is a left side view thereof;

FIG. 6 is a top plan view thereof;

FIG. 7 is a bottom view thereof;

FIG. 8 is a rear view;

FIG. 9 is a reference top plan view indicating the transparent portion A and also the translucent portions B and C; and, FIG. 10 is a reference view showing the enlarged translucent portion C.

The broken lines in FIGS. 5 and 7 are used for illustrative purposes only and form no part of the claimed design.

1 Claim, 10 Drawing Sheets

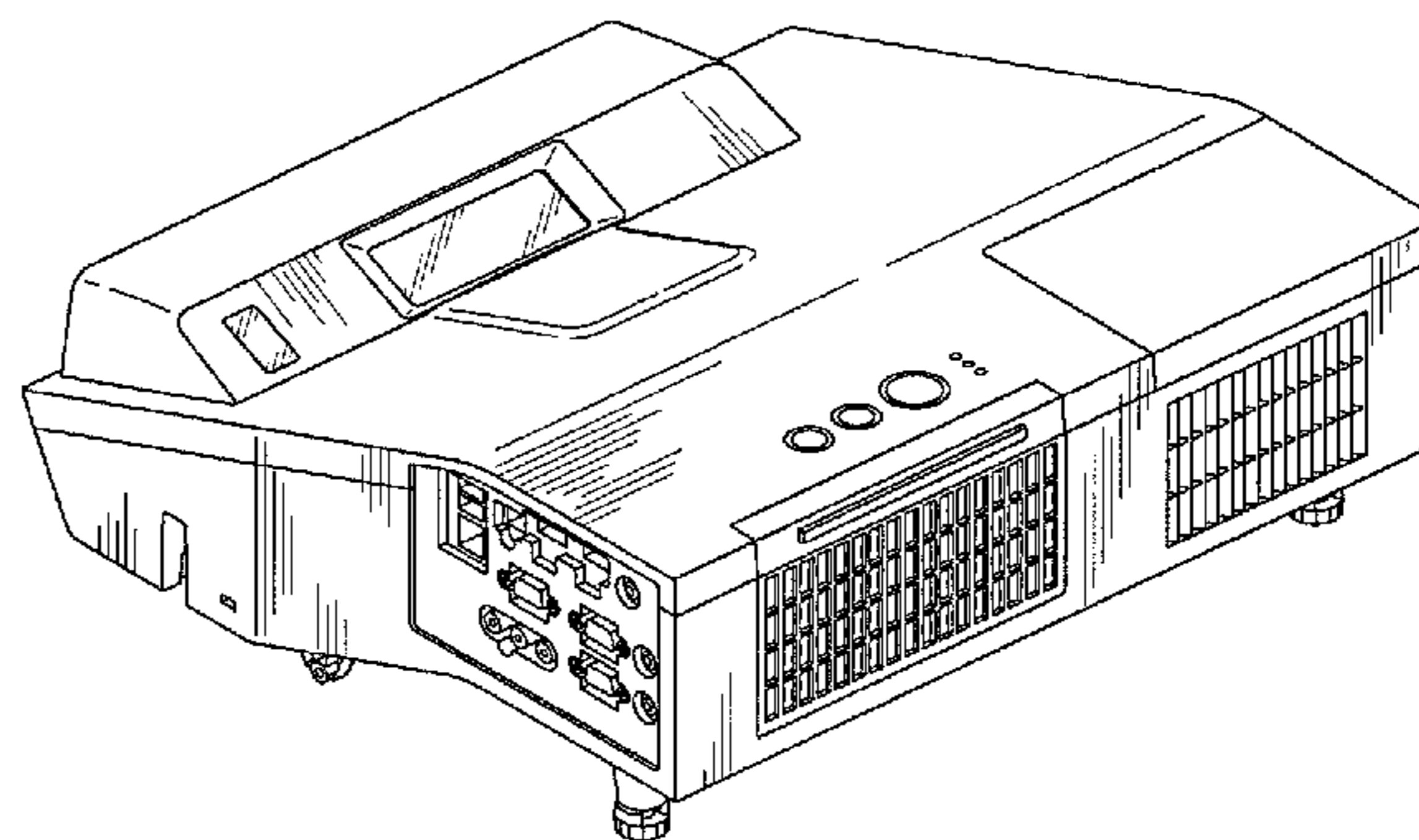
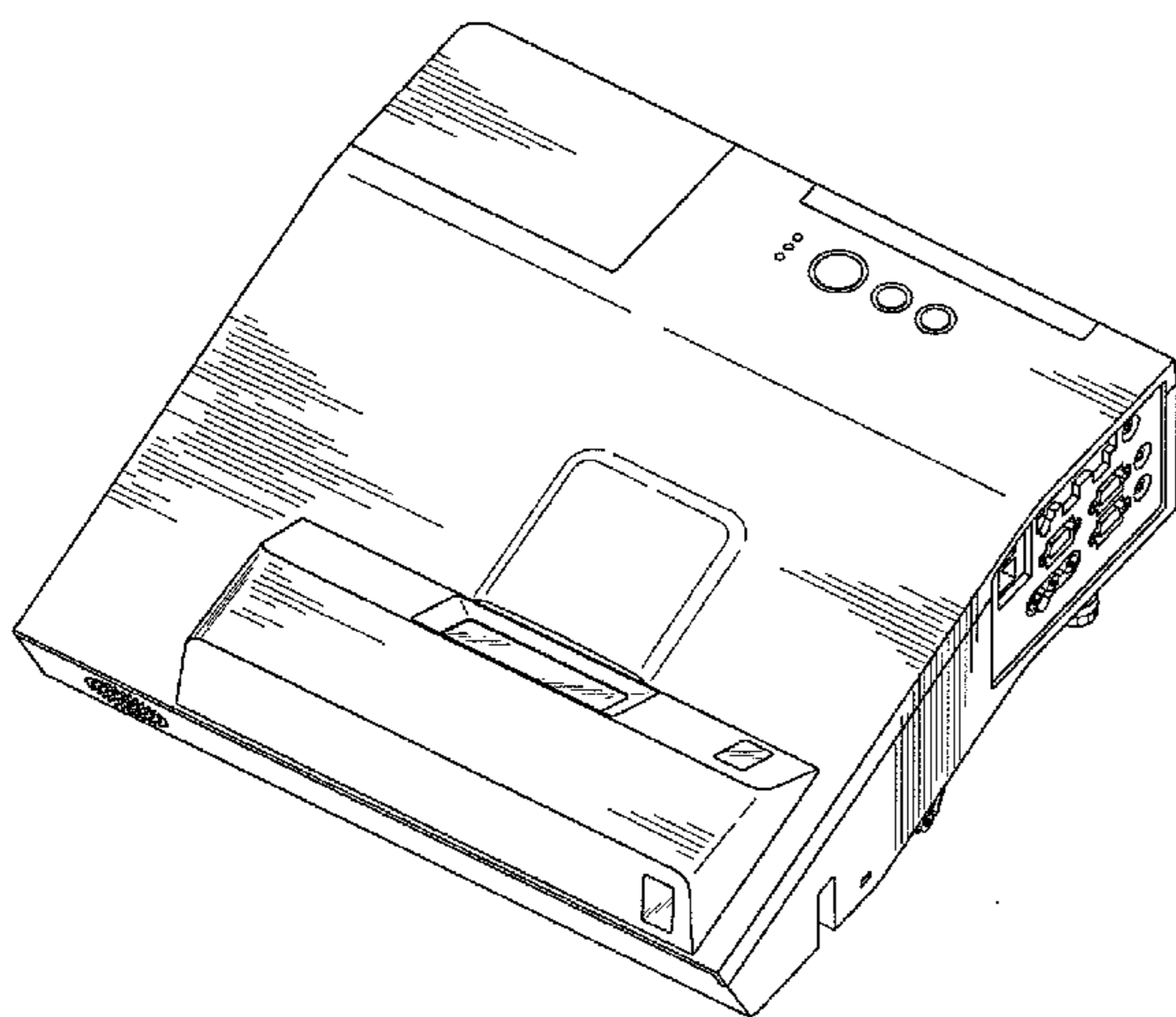

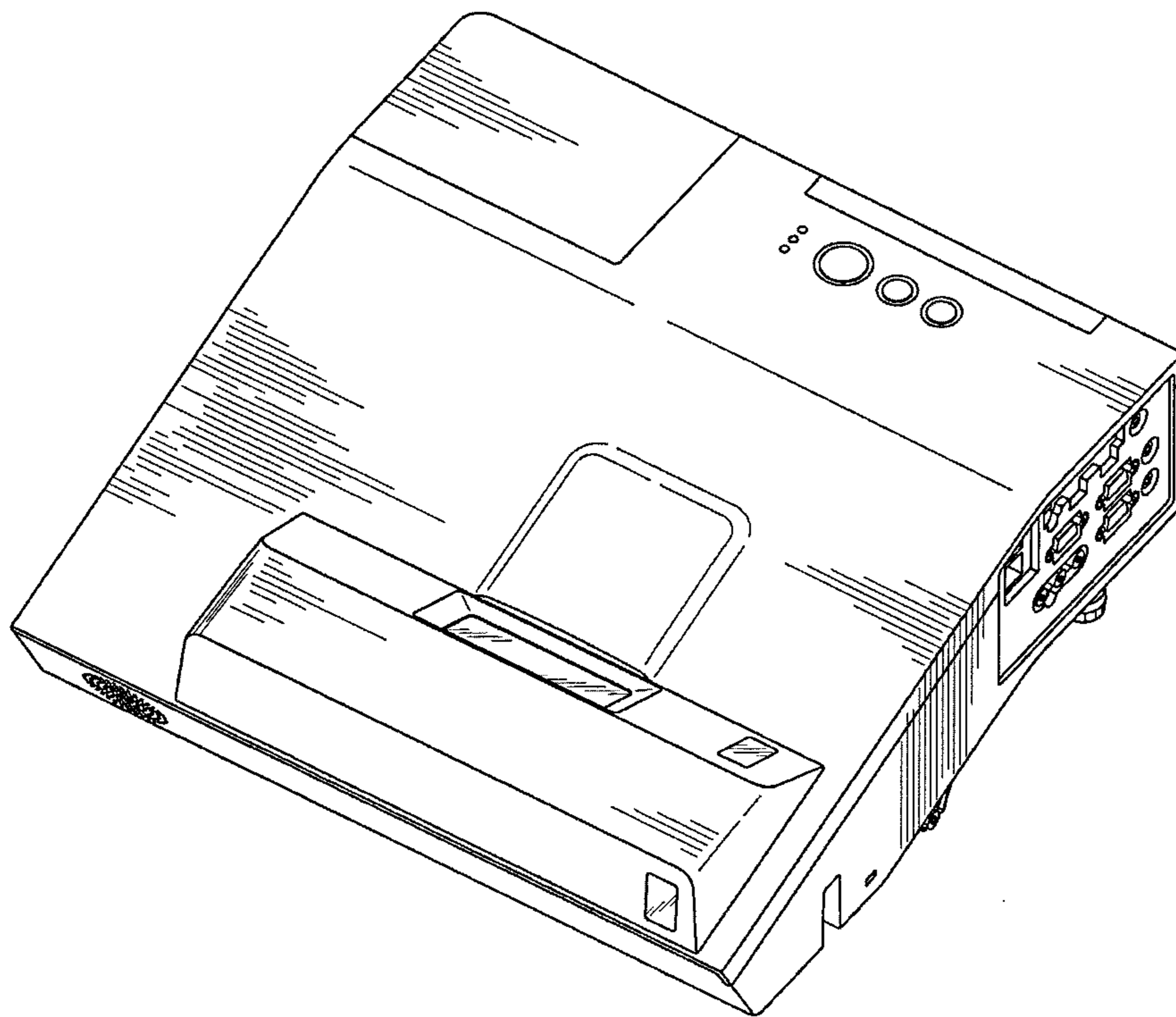

FIG. 1

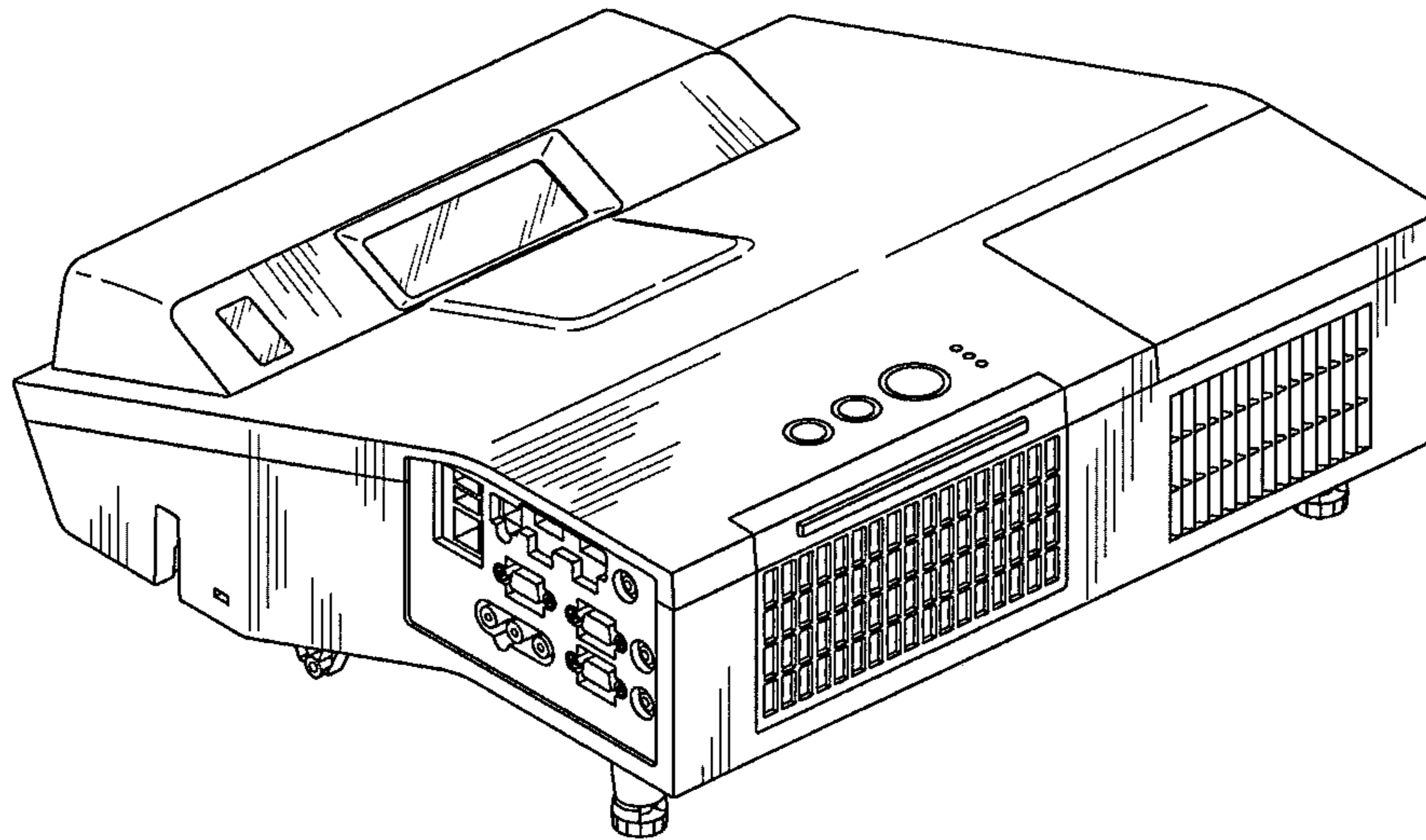

FIG. 2

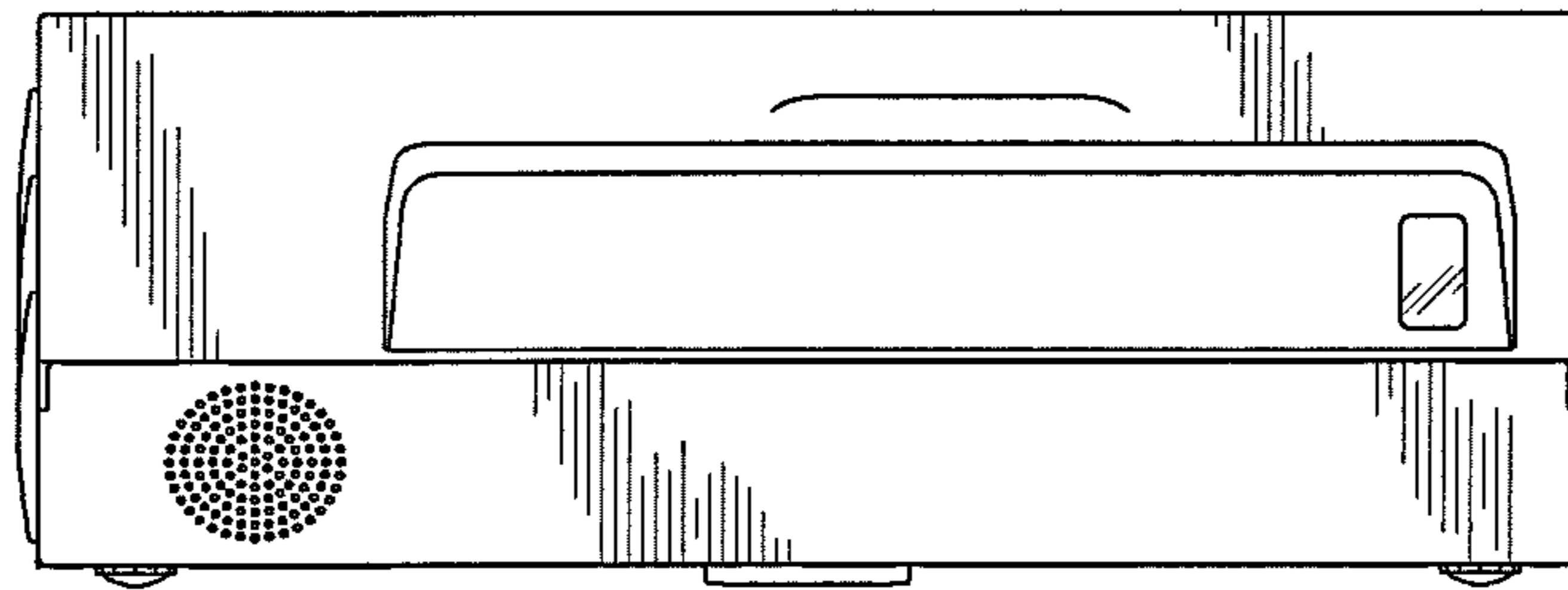

FIG. 3

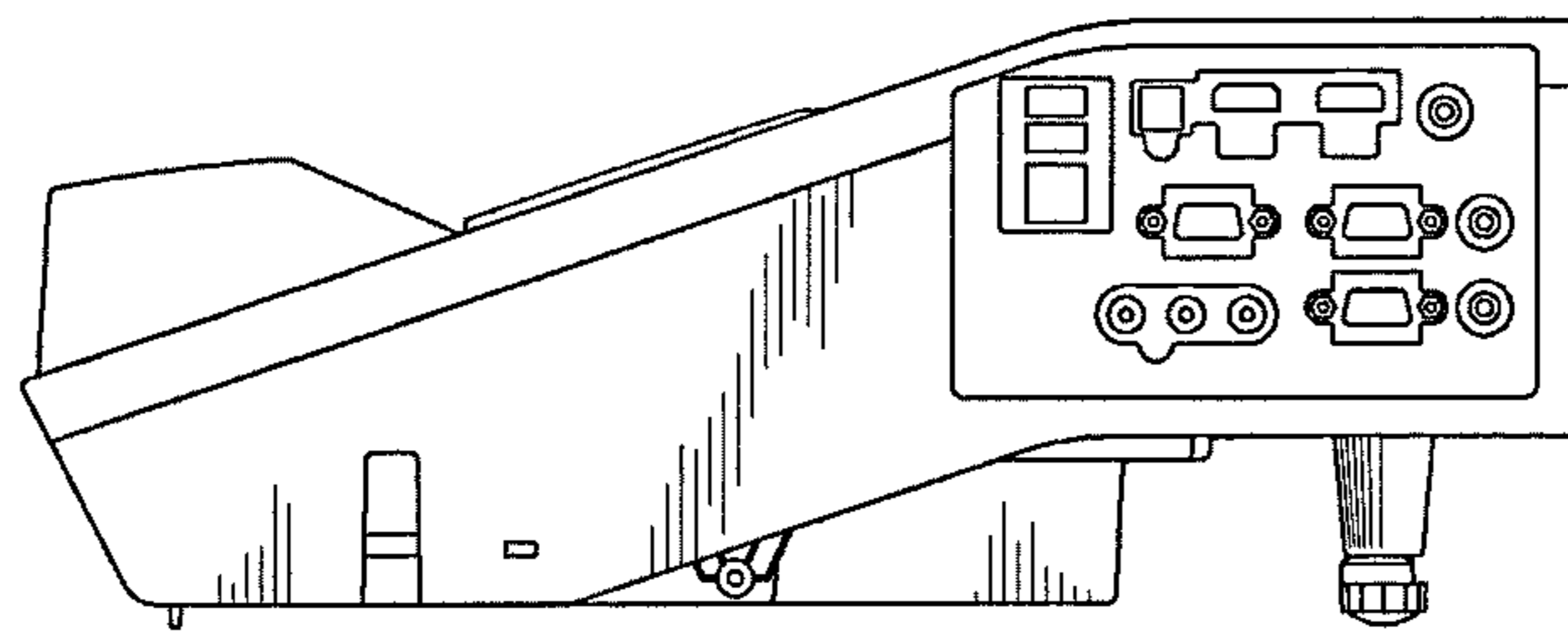

FIG. 4

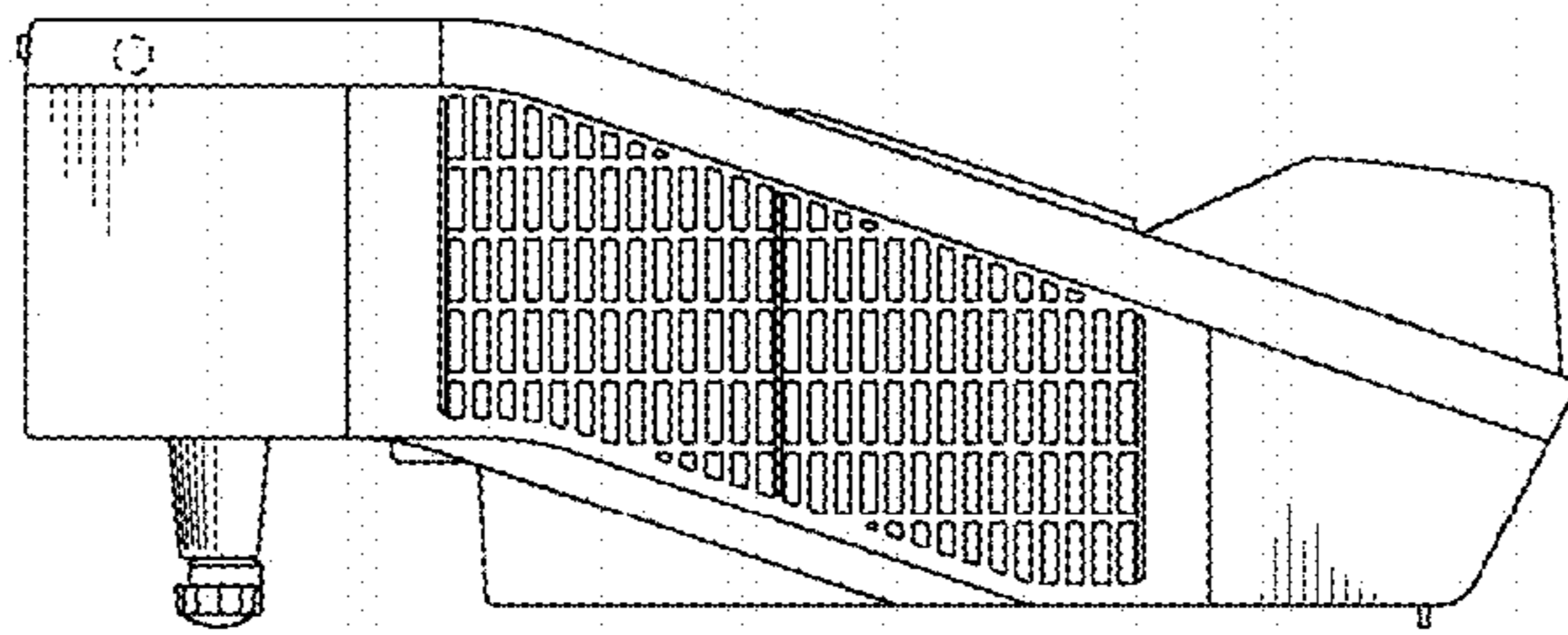

FIG. 5

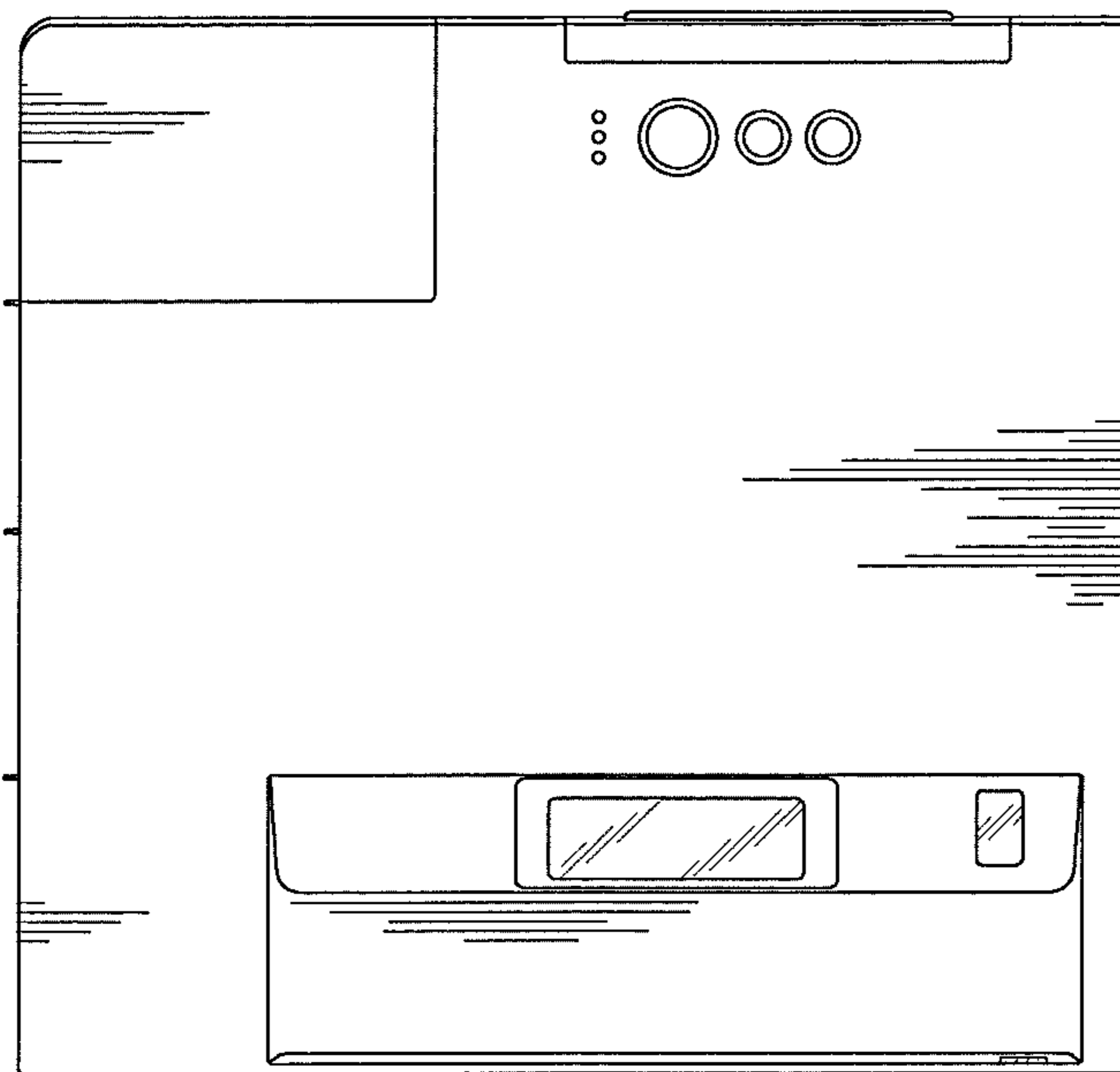

FIG. 6

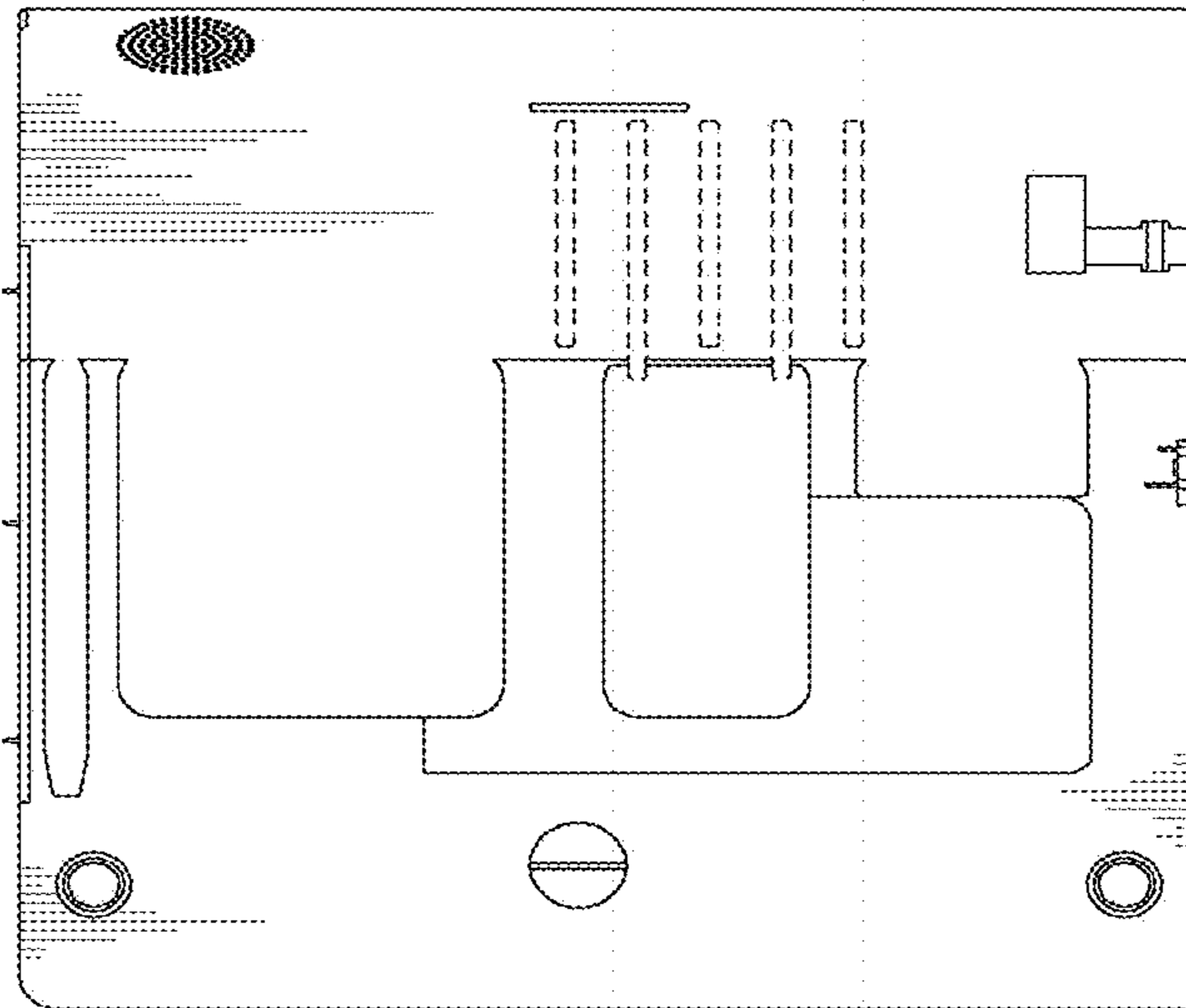

FIG. 7

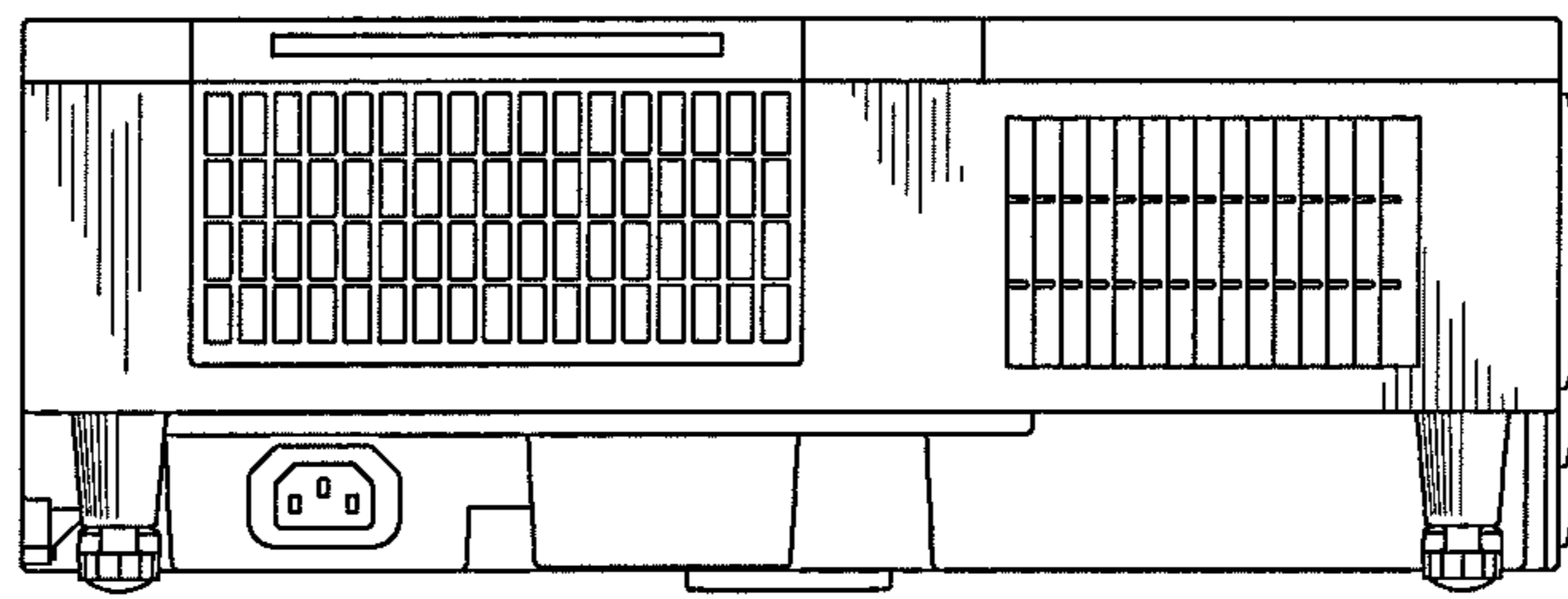

FIG. 8

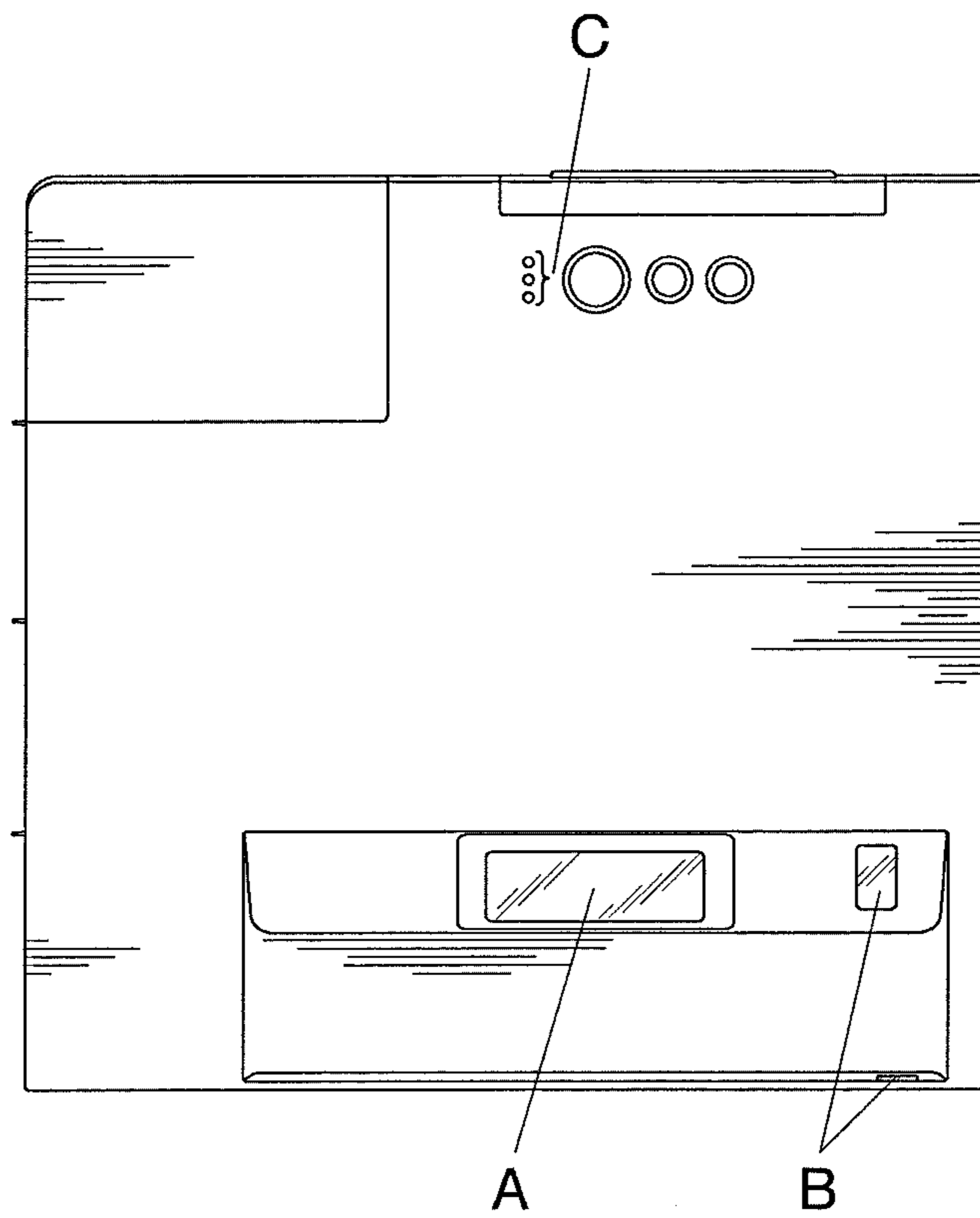

FIG. 9



FIG.10