



US00D744485S

(12) **United States Design Patent**
Young et al.

(10) **Patent No.:** **US D744,485 S**
(45) **Date of Patent:** **** Dec. 1, 2015**

(54) **MOUSE USER INTERFACE WITH CONFIGURABLE COMPONENTS**

2001/0028361 A1 10/2001 Culver
2008/0129693 A1 6/2008 Chen
2011/0227828 A1 9/2011 Blandin

(71) Applicant: **MAD CATZ INTERACTIVE, INC.**,
San Diego, CA (US)

FOREIGN PATENT DOCUMENTS

WO 01/88898 A1 11/2001

(72) Inventors: **Andrew Brian Young**, Oakdale (GB);
Robert Ian Hall, Bristol (GB)

OTHER PUBLICATIONS

(73) Assignee: **MAD CATZ INTERACTIVE, INC.**,
San Diego, CA (US)

Form PCT/ISA/220, PCT/US14/66139, "Notification of Transmittal of the International Search Report and the Written Opinion of the International Searching Authority, or the Declaration", 1 page; Form PCT/ISA/210, PCT/US14/66139, "International Search Report", 2 pages; Form PCT/ISA/237, PCT/US14/66139, "Written Opinion of the International Searching Authority", 4 pages; Search History, 2 pages. Date of Mailing Feb. 23, 2015.

(**) Term: **14 Years**

* cited by examiner

(21) Appl. No.: **29/509,459**

(22) Filed: **Nov. 18, 2014**

(51) **LOC (10) Cl.** **14-02**

(52) **U.S. Cl.**
USPC **D14/409**

(58) **Field of Classification Search**
USPC D14/402-411, 356, 388, 389, 383-385,
D14/417, 426; 345/156-167; 463/36-38;
358/471, 473; 273/148 B

See application file for complete search history.

Primary Examiner — Austin Murphy

(57) **CLAIM**

The ornamental design for a mouse user interface with configurable components, as shown and described.

DESCRIPTION

FIG. 1 is a first top perspective view of a mouse user interface with configurable components;
FIG. 2 is a second top perspective view thereof;
FIG. 3 is a first bottom perspective view thereof;
FIG. 4 is a second bottom perspective view thereof;
FIG. 5 is a top view thereof;
FIG. 6 is a bottom view thereof;
FIG. 7 is a front view thereof;
FIG. 8 is a rear view thereof;
FIG. 9 is a right side view thereof; and,
FIG. 10 is a left side view thereof.
The broken lines in the drawings form no part of the claimed design.

(56) **References Cited**

U.S. PATENT DOCUMENTS

D437,598 S *	2/2001	Han et al.	D14/402
D533,554 S *	12/2006	Sheehan et al.	D14/409
D540,322 S *	4/2007	Fisher et al.	D14/402
D574,379 S *	8/2008	Manalo	D14/406
D594,459 S *	6/2009	Manalo et al.	D14/406
D618,685 S *	6/2010	Haase et al.	D14/409
D627,355 S *	11/2010	Blanchard	D14/402
D669,895 S *	10/2012	Li et al.	D14/409
D688,245 S *	8/2013	Guerra	D14/409
D688,664 S *	8/2013	Guerra	D14/409
D712,903 S *	9/2014	Lai	D14/409
D729,804 S *	5/2015	Jost	D14/410

1 Claim, 10 Drawing Sheets

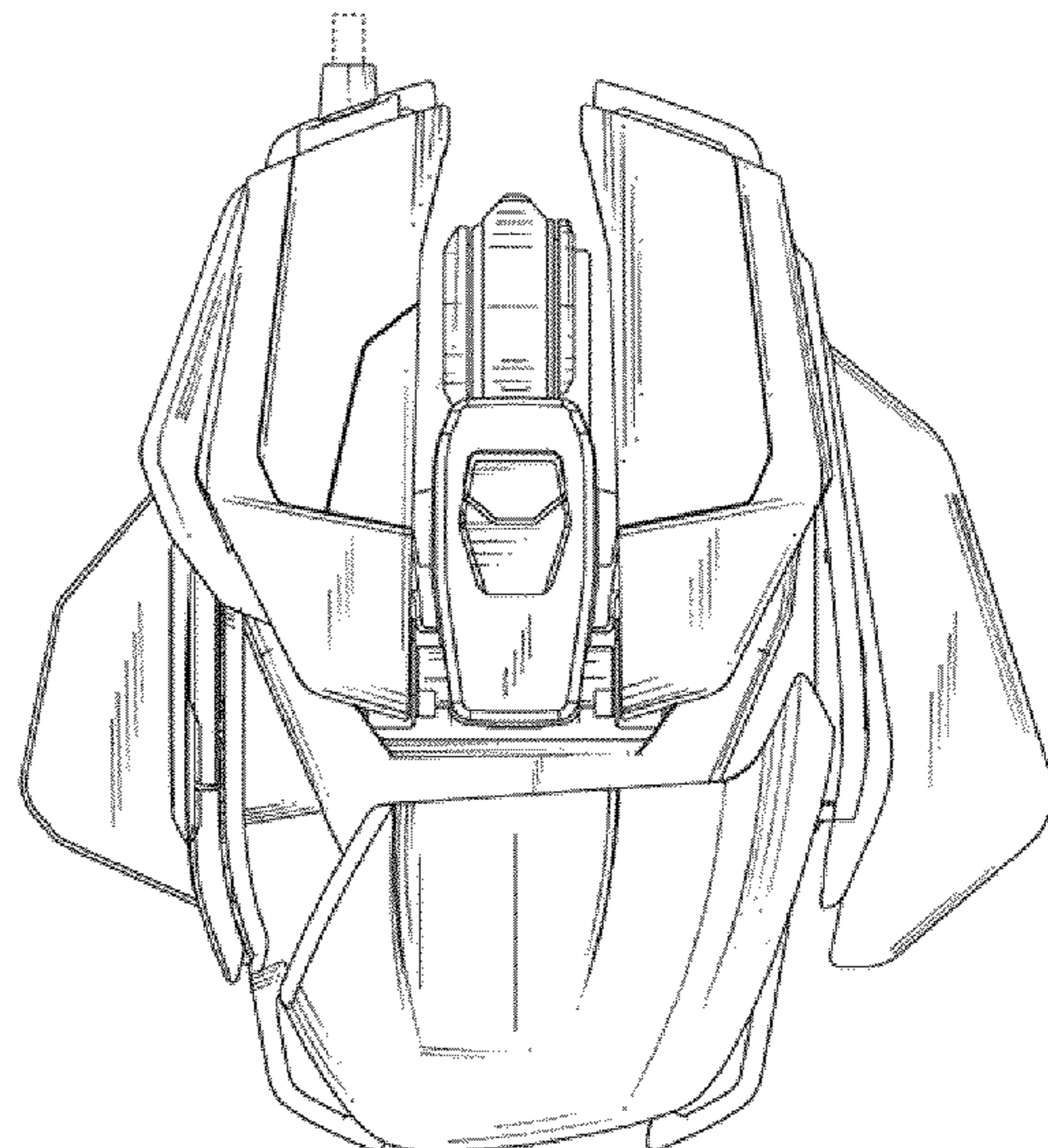
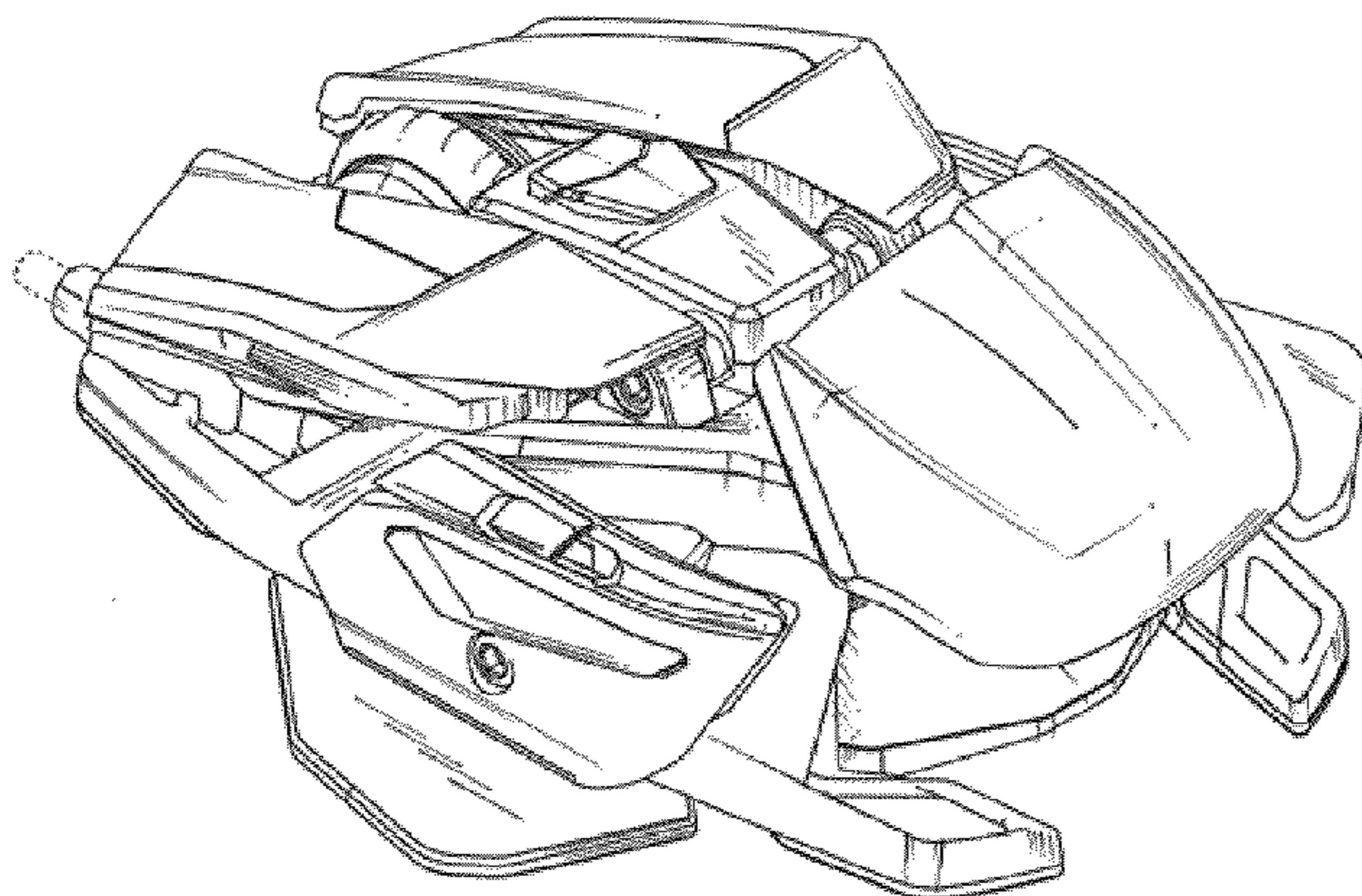

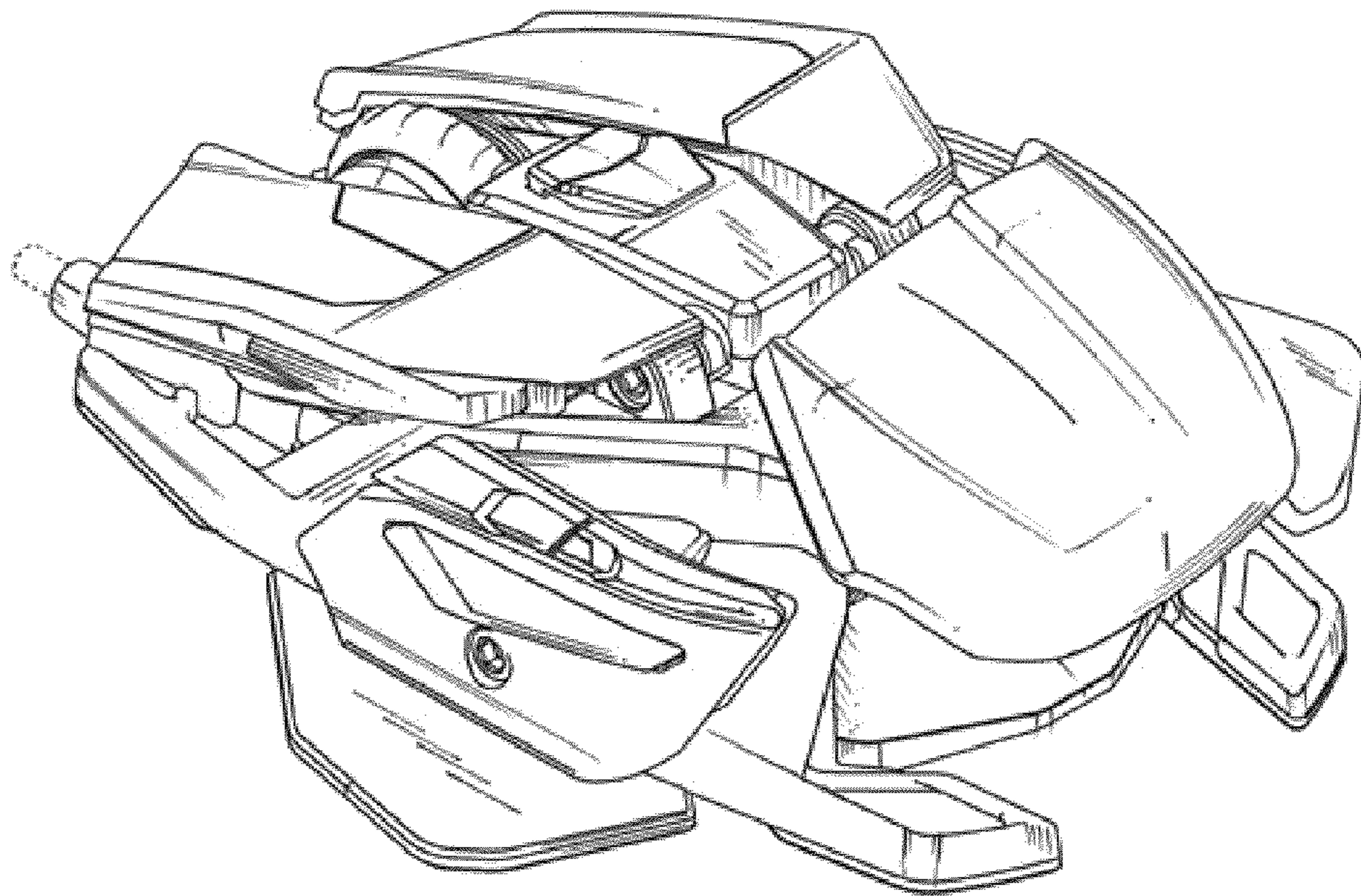

FIG. 1

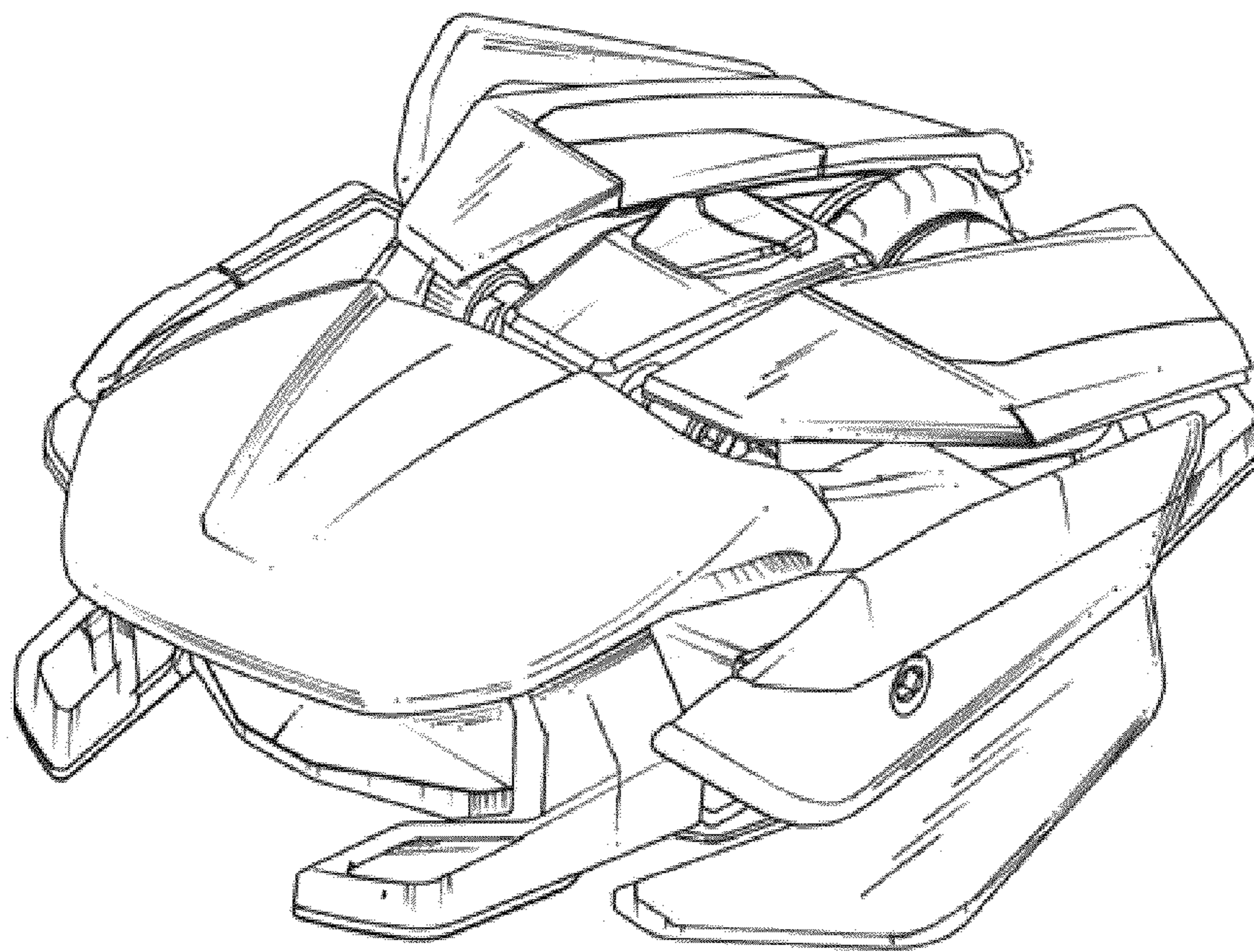

FIG. 2

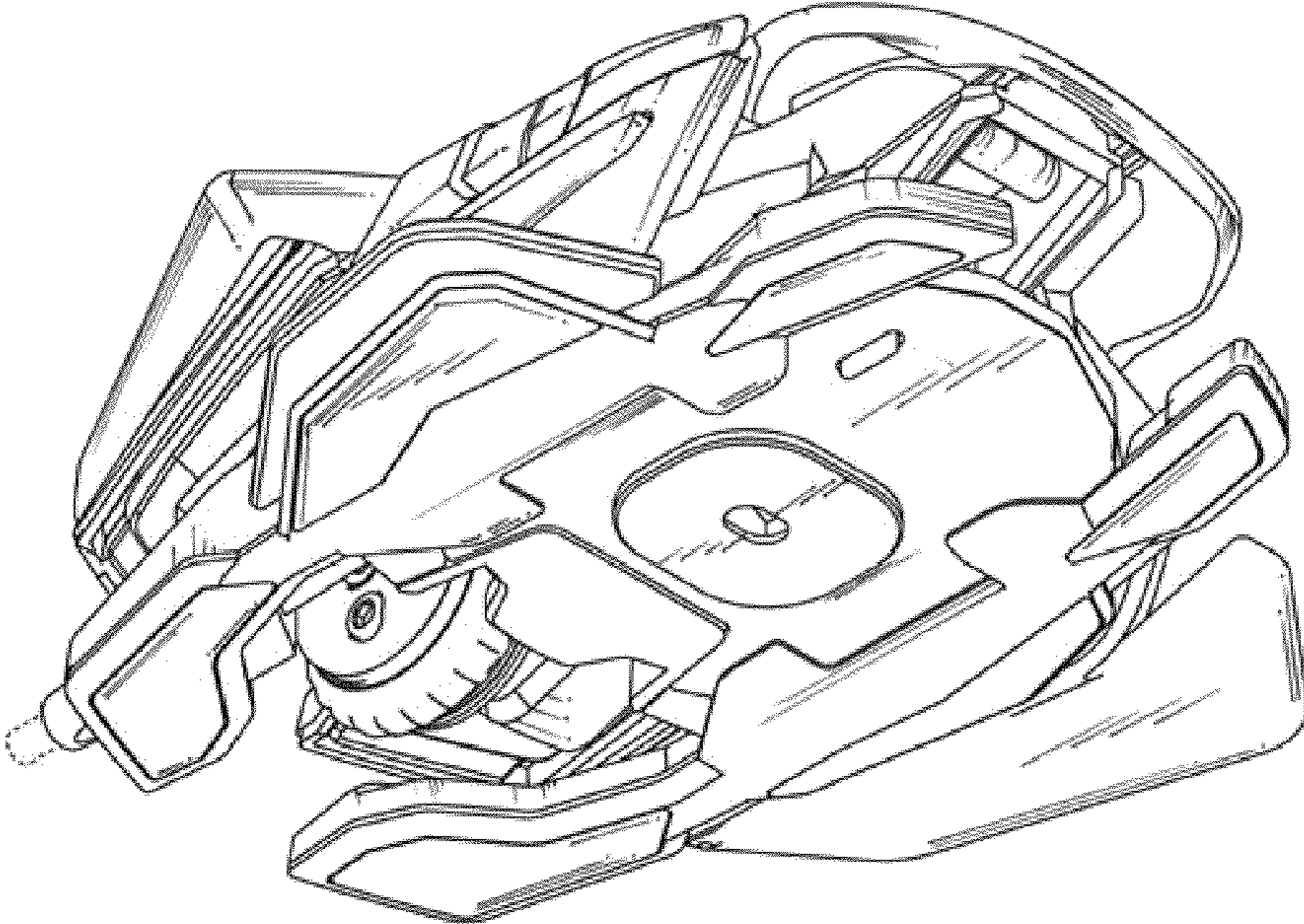

FIG. 3

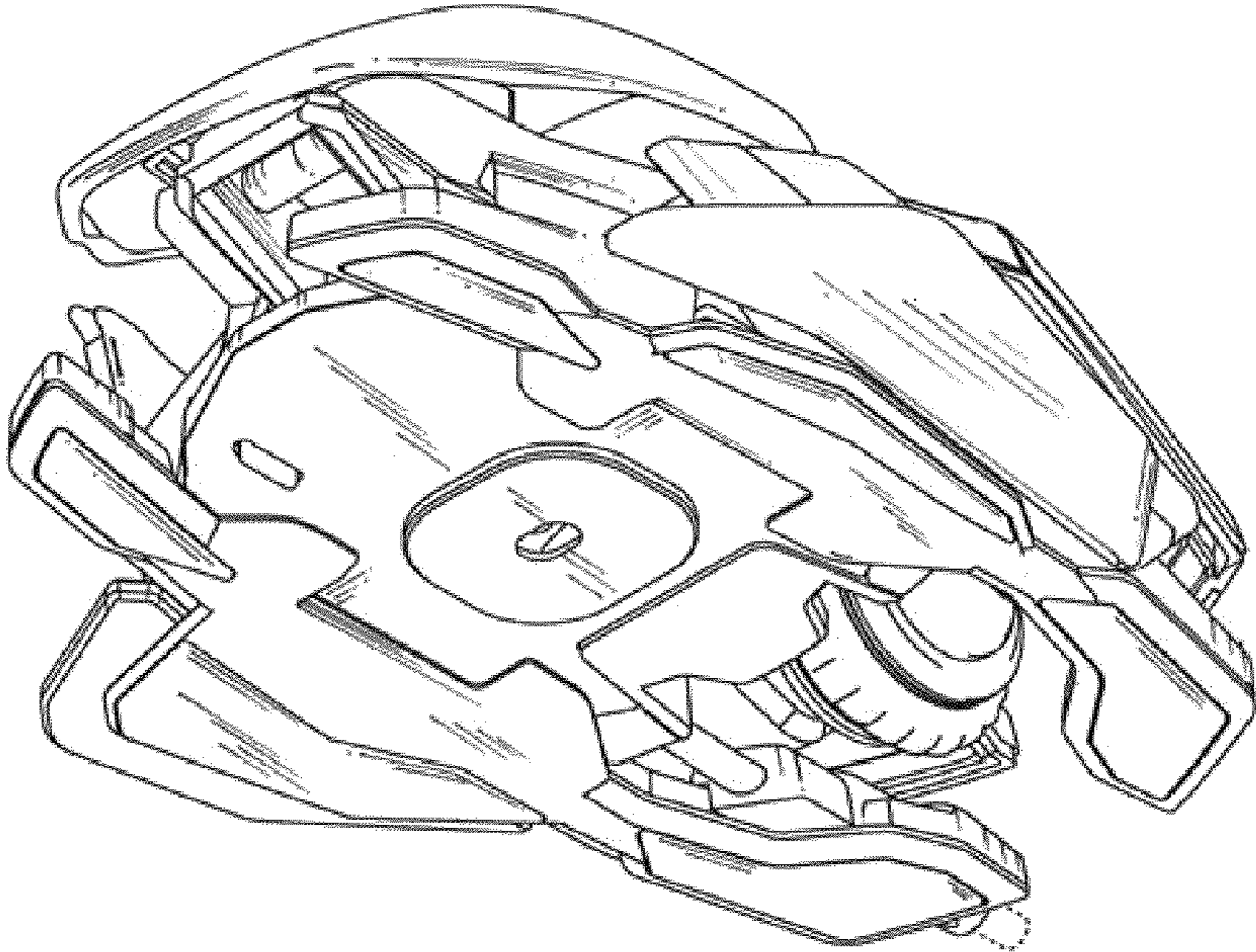

FIG. 4

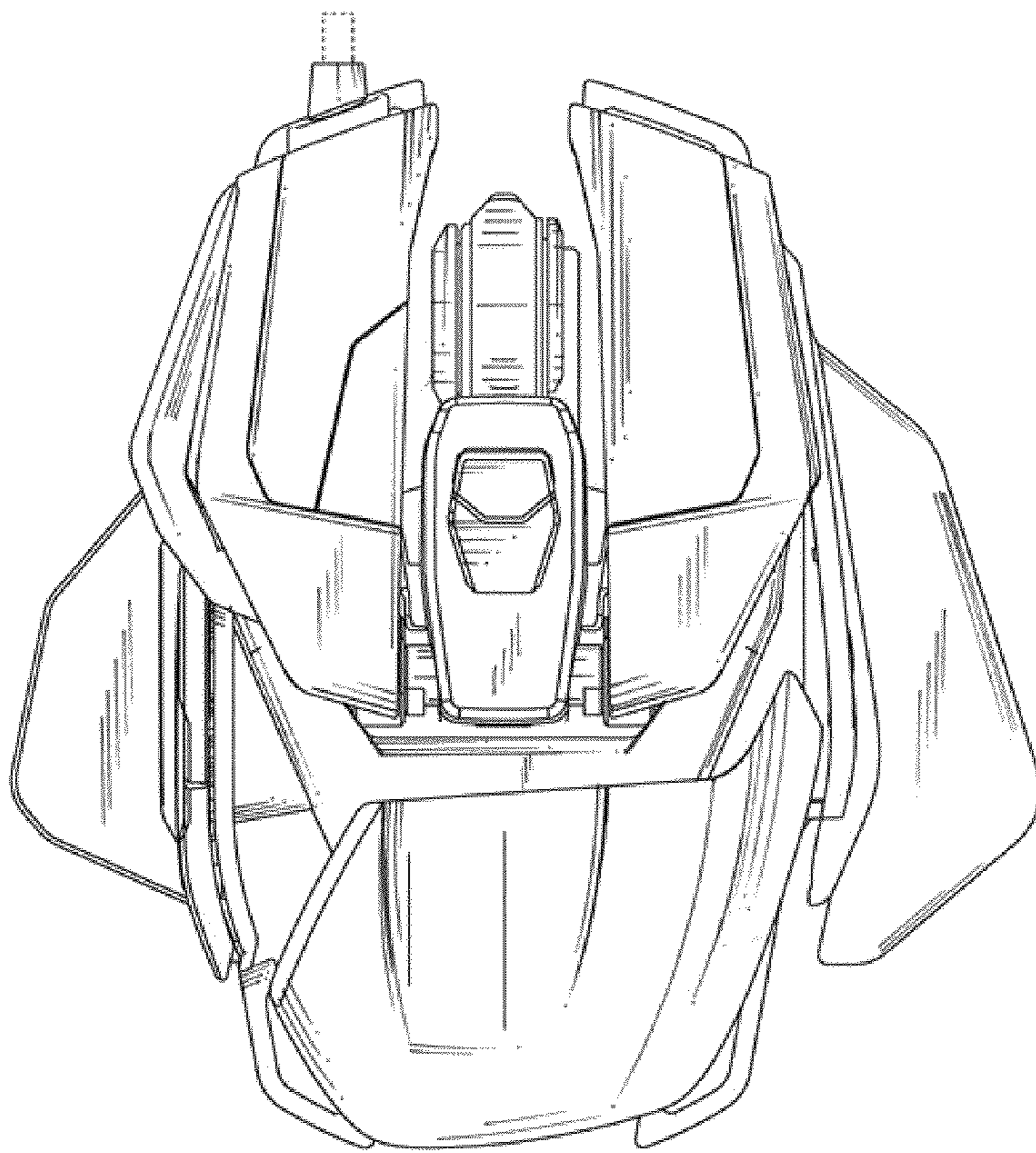

FIG. 5

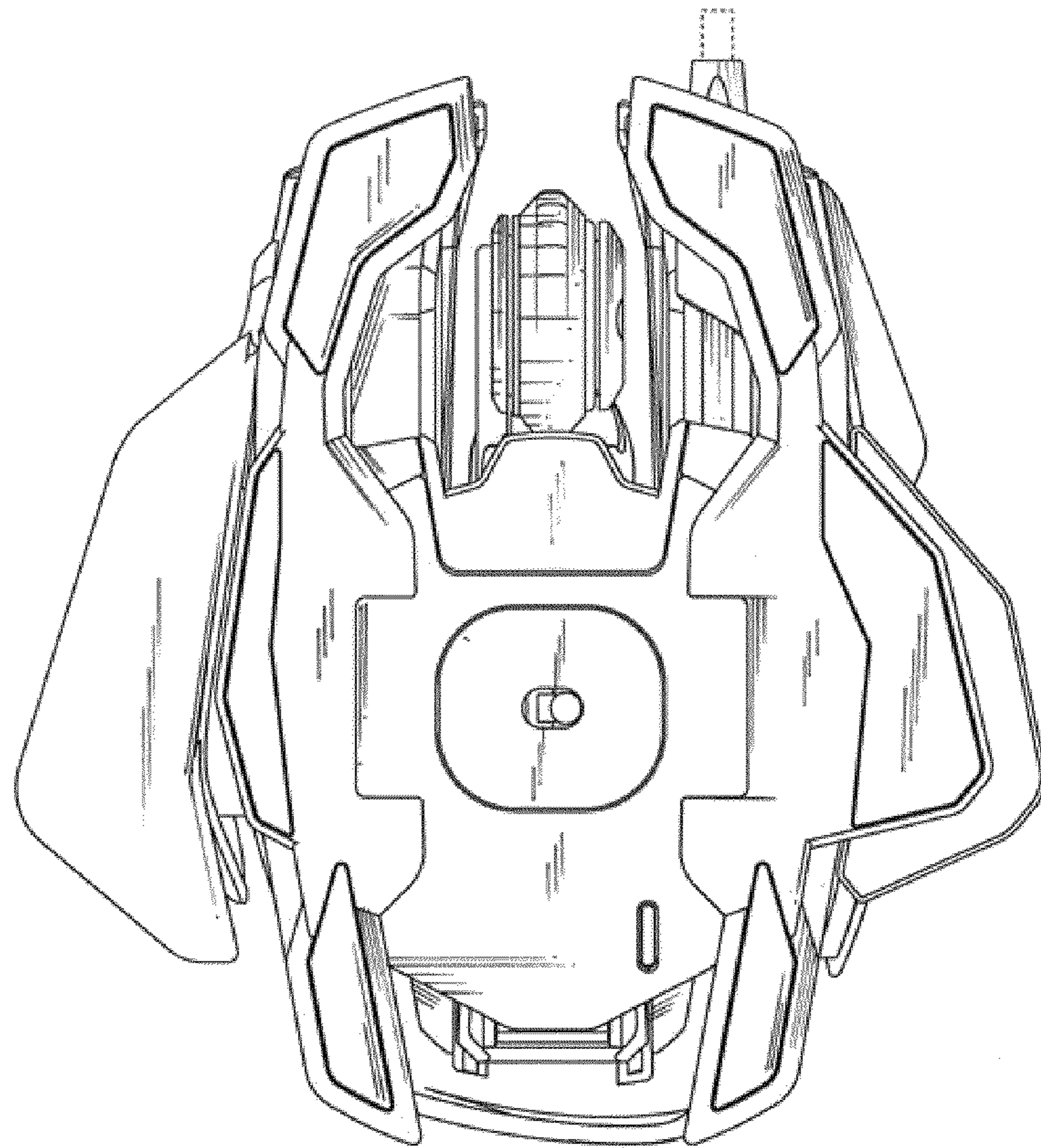

FIG. 6

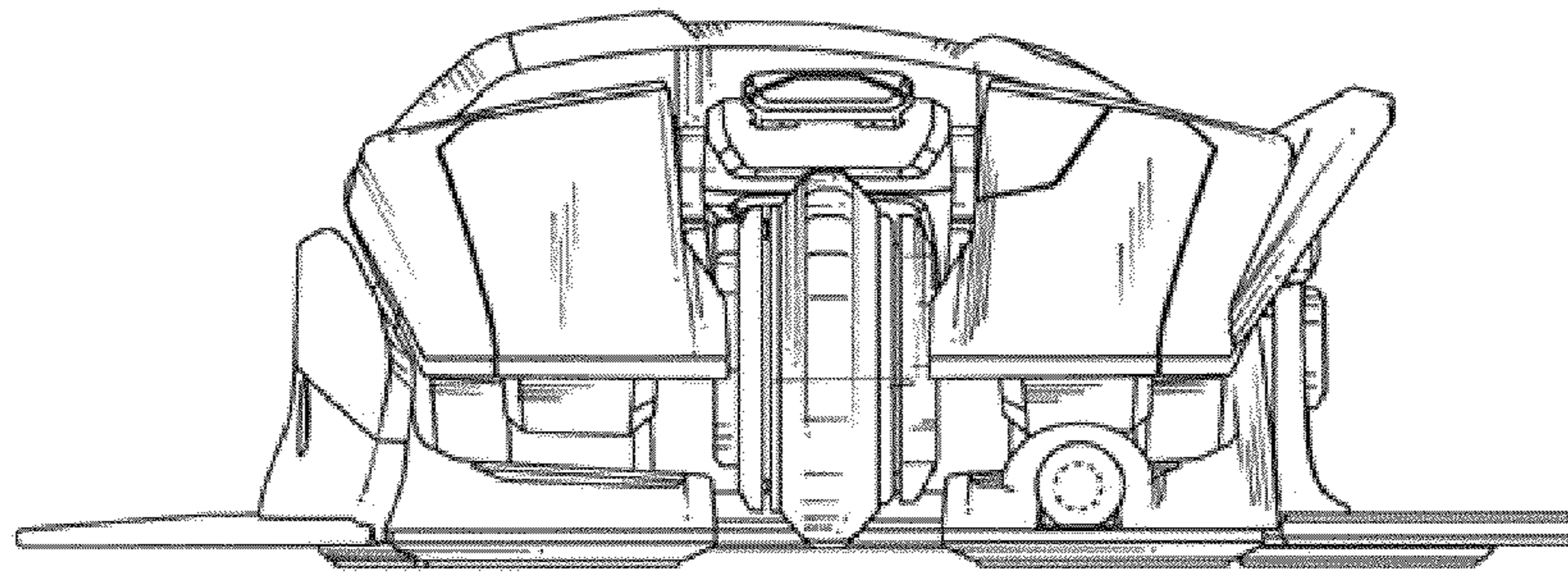

FIG. 7

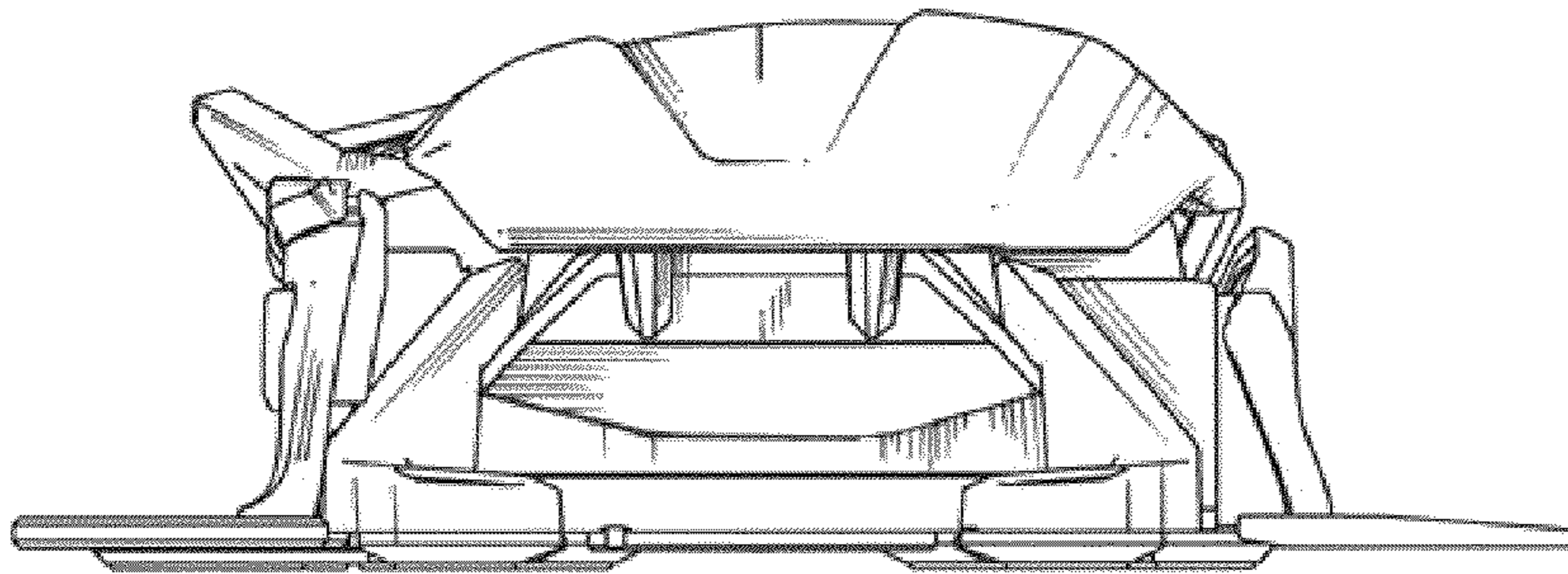

FIG. 8

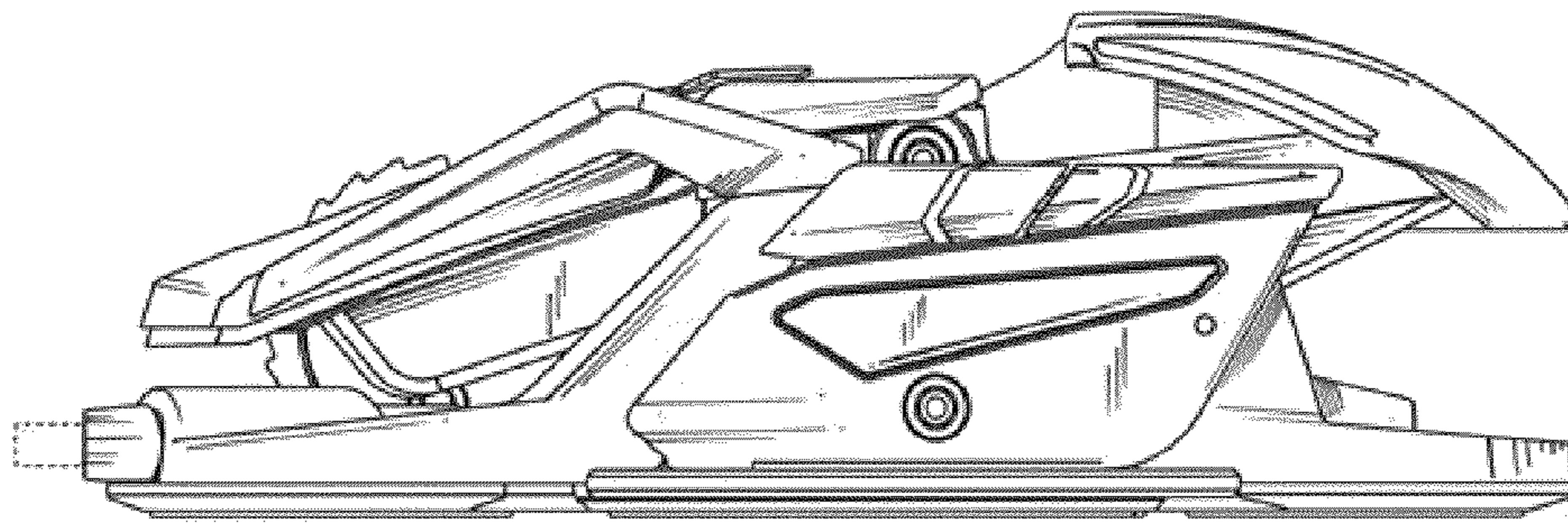

FIG. 9

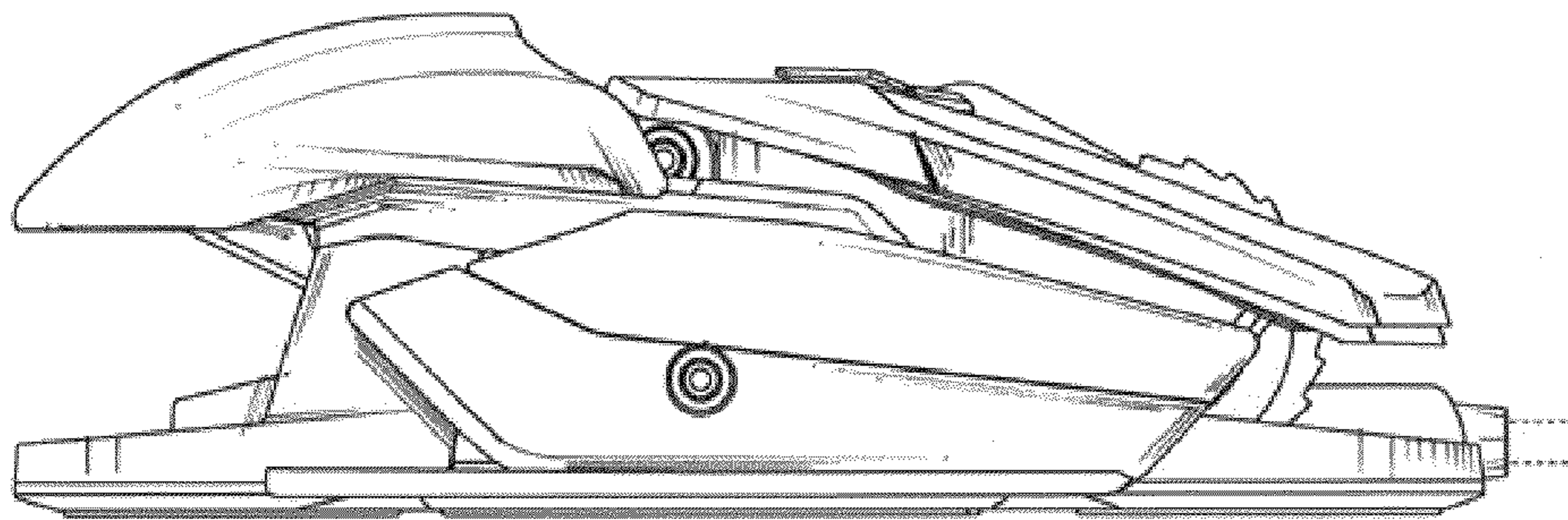

FIG. 10