



US00D744481S

(12) **United States Design Patent**
Yokoyama

(10) **Patent No.:** **US D744,481 S**
(45) **Date of Patent:** **** Dec. 1, 2015**

(54) **TABLET COMPUTER WITH GOLD AND WHITE BODY**

(71) Applicant: **Kabushiki Kaisha Toshiba**, Minato-ku, Tokyo (JP)

(72) Inventor: **Hiroko Yokoyama**, Tokyo (JP)

(73) Assignee: **Kabushiki Kaisha Toshiba**, Minato-ku, Tokyo (JP)

(**) Term: **14 Years**

(21) Appl. No.: **29/490,429**

(22) Filed: **May 9, 2014**

(30) **Foreign Application Priority Data**

Dec. 18, 2013 (JP) 2013-029691
Dec. 18, 2013 (JP) 2013-029694

(51) **LOC (10) Cl.** **14-02**

(52) **U.S. Cl.**
USPC **D14/341**

(58) **Field of Classification Search**

USPC D14/341-347, 137, 138 R, 138 AA, D14/138 C, 138 G, 496, 203.1, 203.3, 203.4, D14/203.7, 129, 130, 147, 218, 247, 248, D14/250, 374, 371, 385, 388, 389, 315-318, D14/420, 426, 439, 440; D10/104.1; D19/26, 59, 60; D21/324, 329, 330, D21/332; 248/917-924; 463/37; 455/556.1, 455/556.2, 566, 575.1, 90.3; 379/433.04, 379/433.01, 433.06, 916; 345/173, 901, 345/905; 348/376; 361/679.26, 679.21, 361/679.27, 679.3, 679.55, 679.56, 679.59
CPC ... G06F 1/1613; G06F 1/1624; G06F 1/1626; G06F 1/165; G06F 3/0485; G06F 3/0488; H04M 1/0202; H04M 1/0279; H04M 1/0281; H04M 1/0283; H04M 1/0214; H04M 1/72544; H04M 1/7255

See application file for complete search history.

(56) **References Cited**

U.S. PATENT DOCUMENTS

D636,769 S * 4/2011 Wood D14/341
D654,074 S 2/2012 Wood et al.

(Continued)

FOREIGN PATENT DOCUMENTS

JP 1423630 8/2011
JP 1446853 6/2012

(Continued)

Primary Examiner — Eric Goodman

Assistant Examiner — Clese Moore, Jr.

(74) *Attorney, Agent, or Firm* — Banner & Witcoff, Ltd.

(57) **CLAIM**

The ornamental design for a tablet computer with gold and white body, as shown and described.

DESCRIPTION

The patent or application file contains at least one drawing executed in color. Copies of this patent or patent application with color drawings(s) will be provided by the Office upon request and payment of the necessary fee.

FIG. 1 is a perspective view of a tablet computer with gold and white body showing my new design according to a first embodiment thereof,

FIG. 2 is a front elevational view thereof,

FIG. 3 is a rear elevational view thereof,

FIG. 4 is a left side elevational view thereof,

FIG. 5 is a right side elevational view thereof,

FIG. 6 is a top plan view thereof,

FIG. 7 is a bottom plan view thereof,

FIG. 8 is a perspective view of a tablet computer with gold and white body showing my new design according to a second embodiment thereof,

FIG. 9 is a front elevational view thereof,

FIG. 10 is a rear elevational view thereof,

FIG. 11 is a left side elevational view thereof,

FIG. 12 is a right side elevational view thereof,

FIG. 13 is a top plan view thereof; and,

FIG. 14 is a bottom plan view thereof.

The broken lines shown illustrate portions of the tablet computer with gold and white body that form no part of the claimed design. The portion bounded within the broken lines form no part of the claimed design. The claimed portion of the tablet computer includes gold and white colors.

1 Claim, 14 Drawing Sheets
(8 of 14 Drawing Sheet(s) Filed in Color)

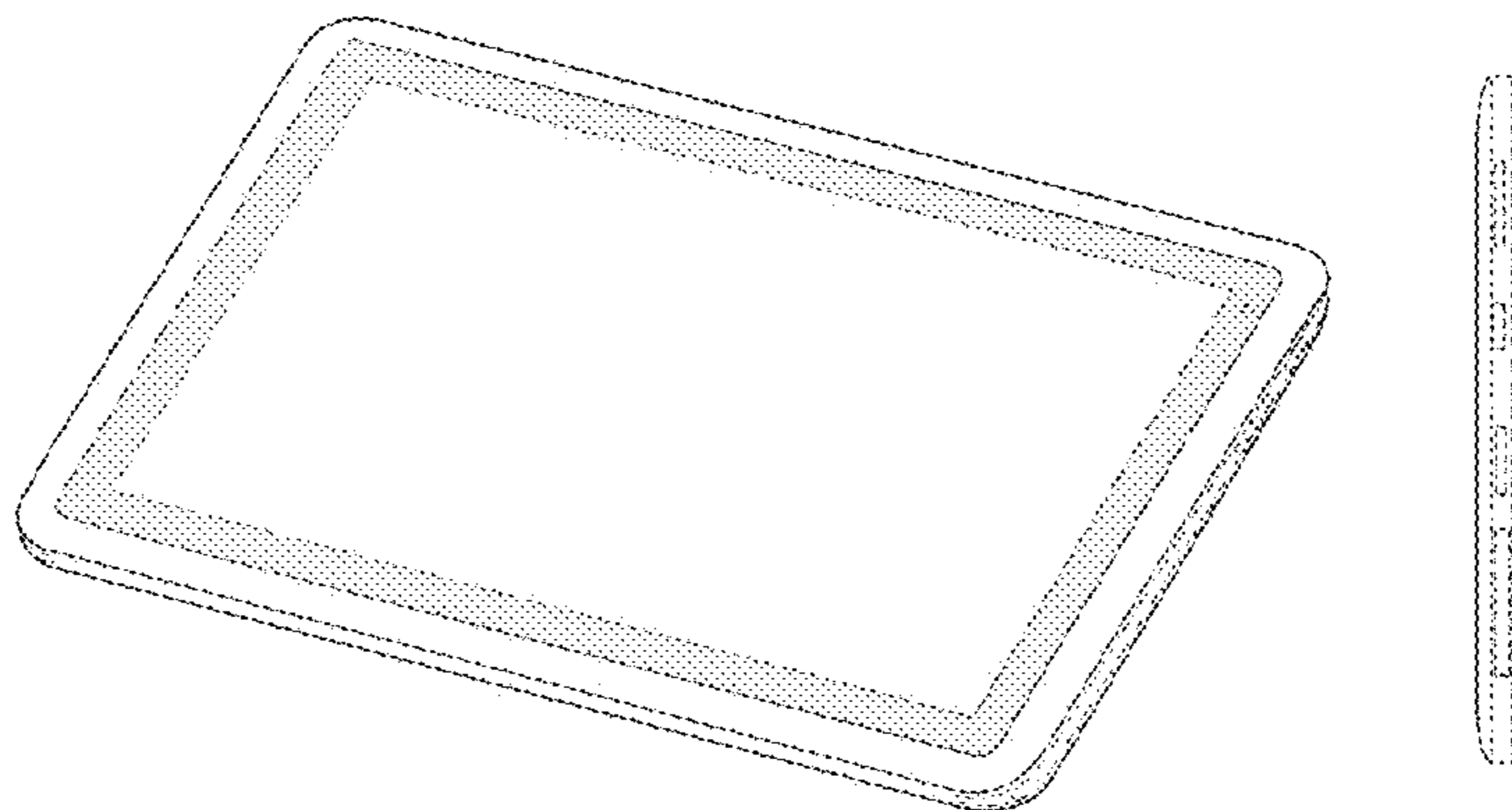

(56)

References Cited

U.S. PATENT DOCUMENTS

D663,298 S * 7/2012 Song D14/341
D664,954 S * 8/2012 Kim D14/341
D667,397 S * 9/2012 Koh D14/341
D667,399 S * 9/2012 Koh D14/341
D687,820 S * 8/2013 Kim D14/341
D687,823 S * 8/2013 Ryu D14/341
D688,661 S * 8/2013 Ho D14/341
D691,996 S * 10/2013 Ohshima D14/341
D693,340 S * 11/2013 Ohshima D14/341
D696,246 S * 12/2013 Kim D14/341
D696,250 S * 12/2013 Wang D14/341

D696,662 S * 12/2013 Song D14/341
D697,065 S * 1/2014 Kim D14/138 AD
D702,229 S * 4/2014 Lim D14/341
D703,668 S * 4/2014 Kim D14/138 AD
D716,293 S * 10/2014 Hwang D14/341
D720,745 S * 1/2015 Yeo D14/341
D729,236 S * 5/2015 Lee D14/341
D736,202 S * 8/2015 Solomon D14/341

FOREIGN PATENT DOCUMENTS

JP 1422269 8/2012
KR 30-0627872 1/2012

* cited by examiner

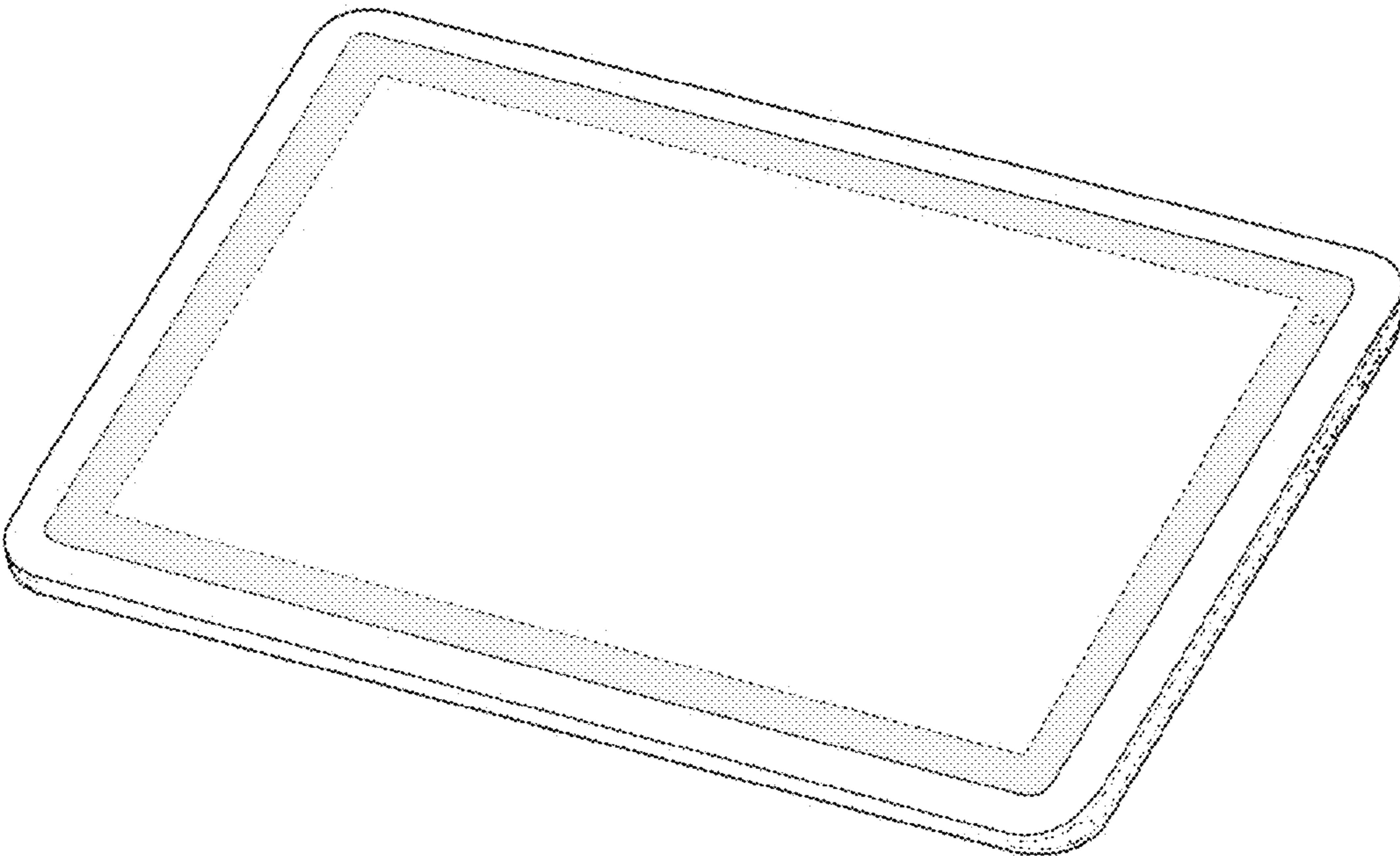

FIG. 1

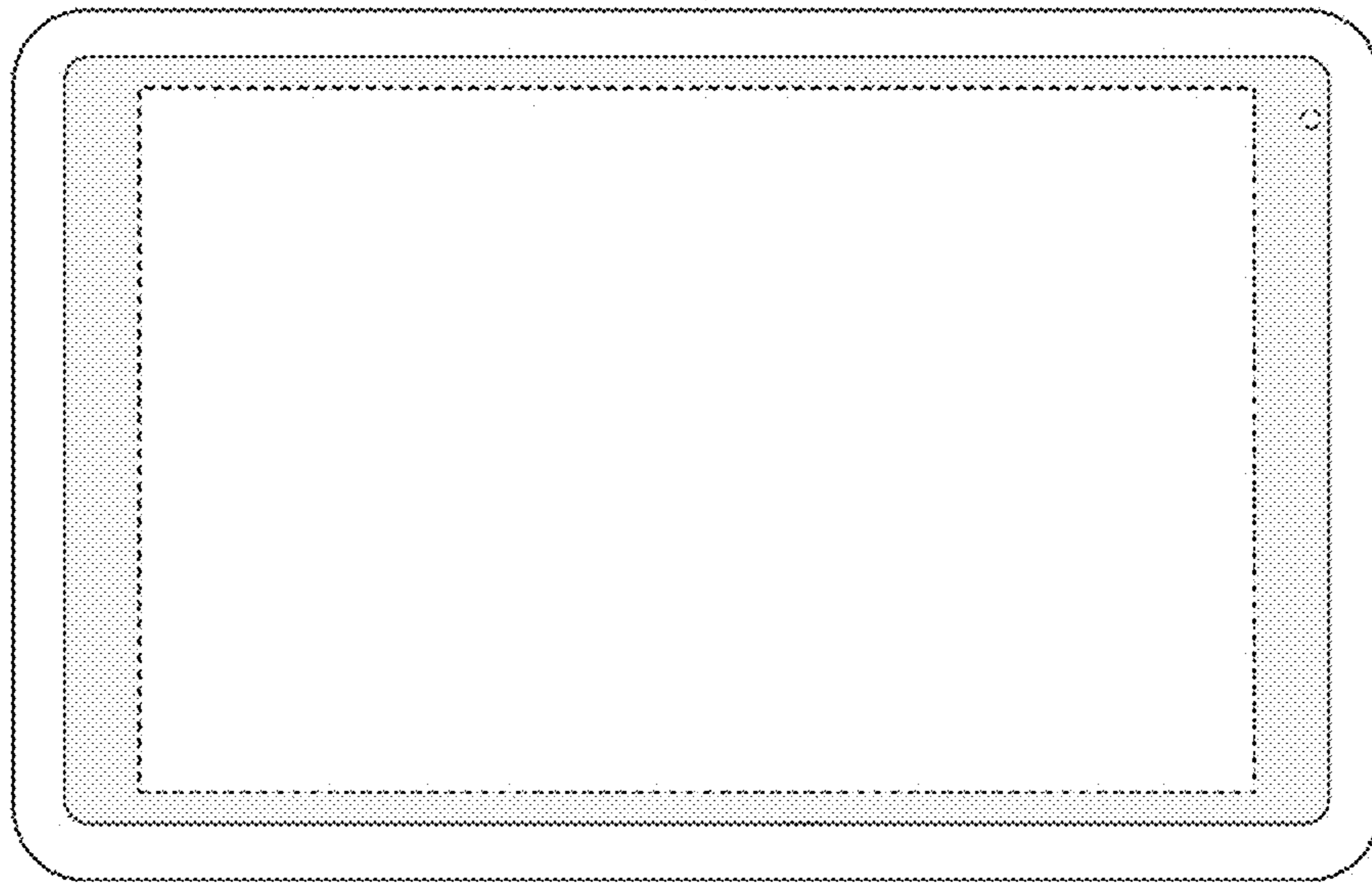

FIG. 2



FIG. 3

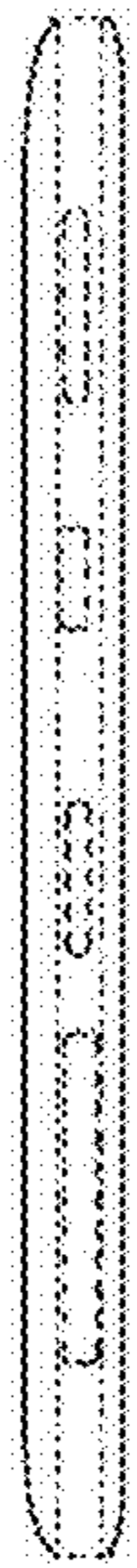

FIG. 4

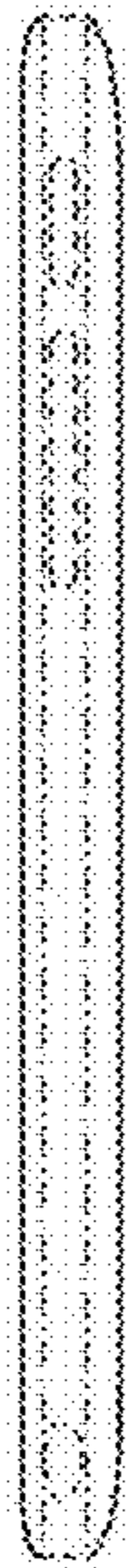

FIG. 5



FIG. 6



FIG. 7

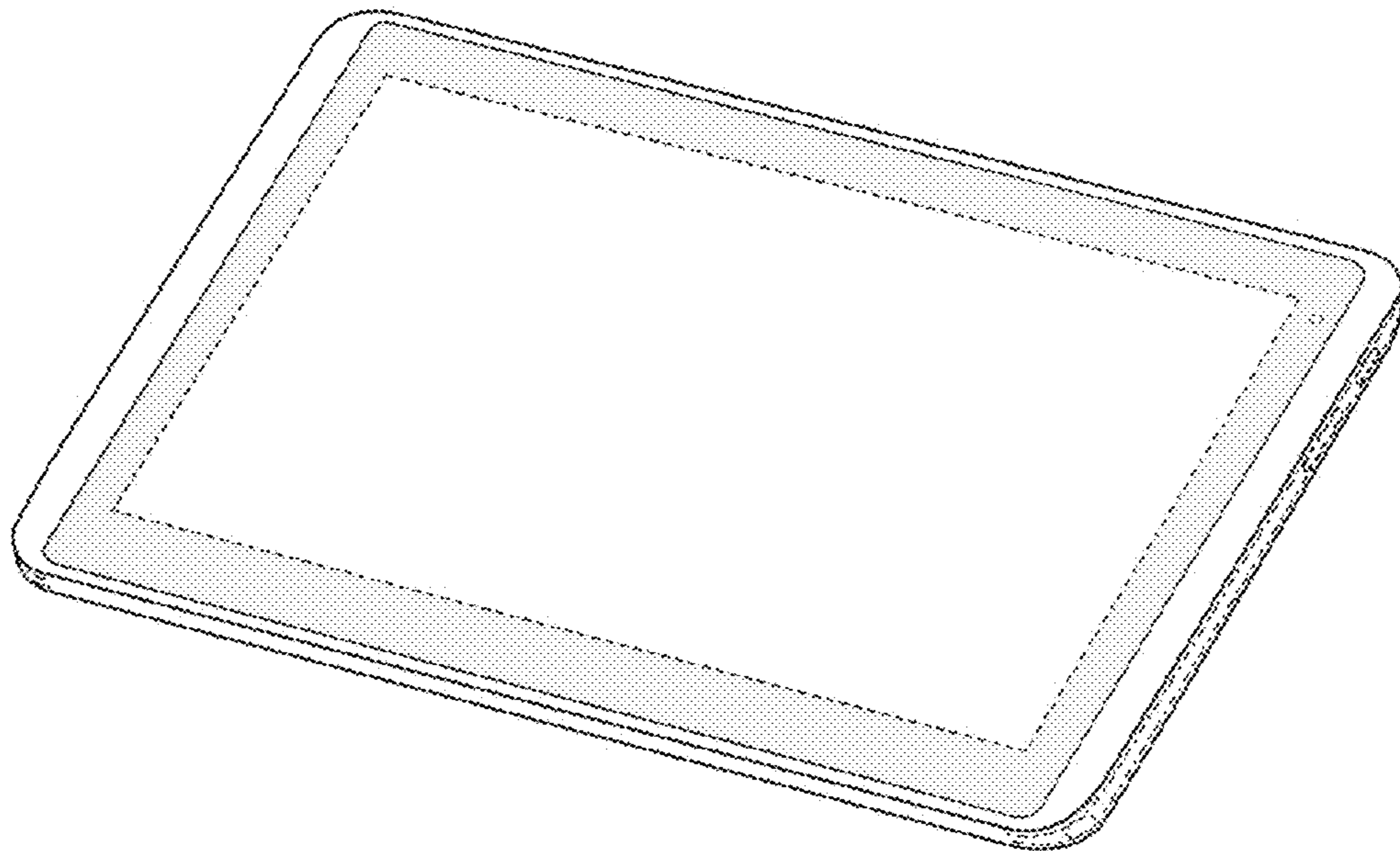

FIG. 8

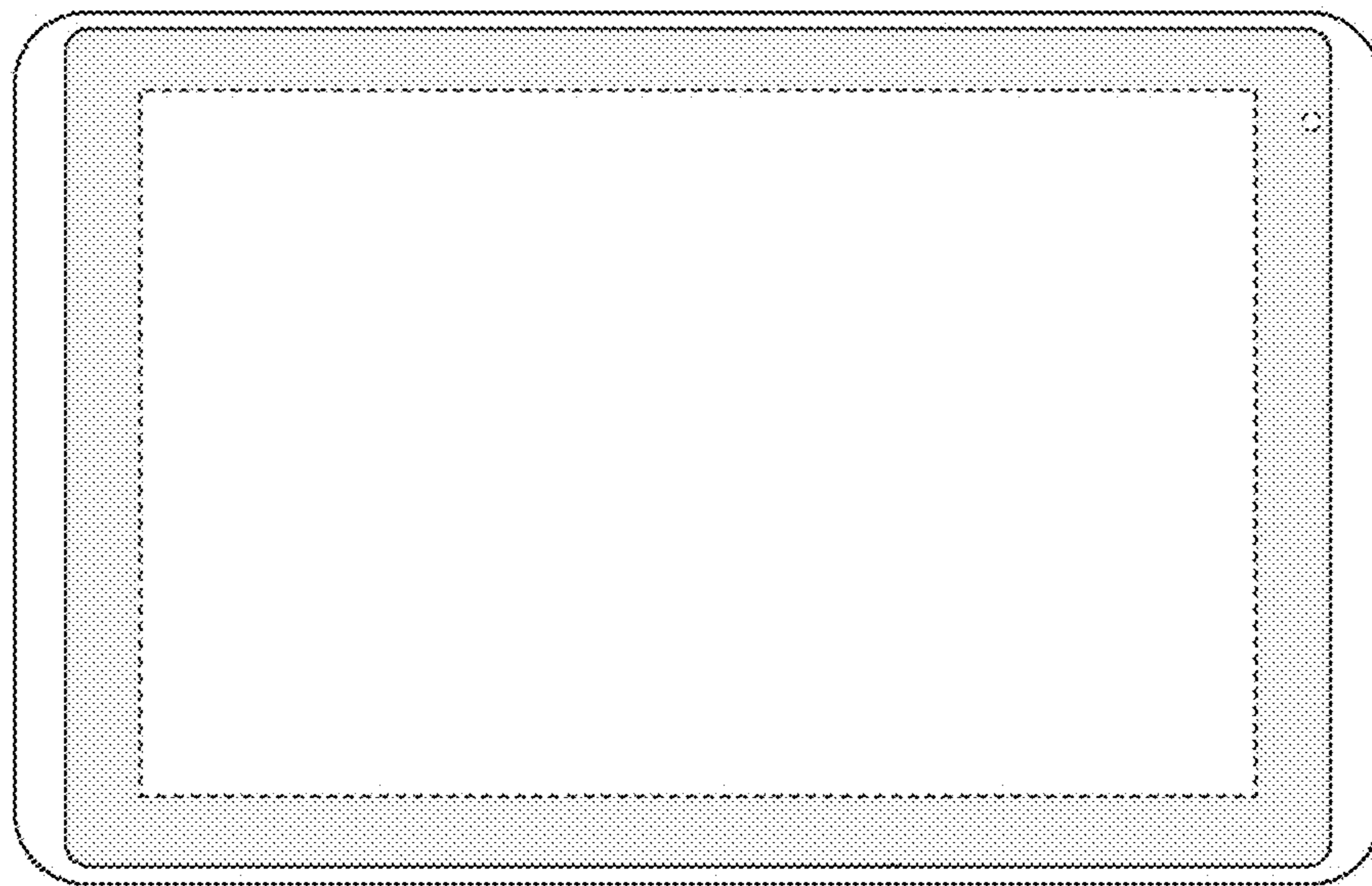

FIG. 9



FIG. 10

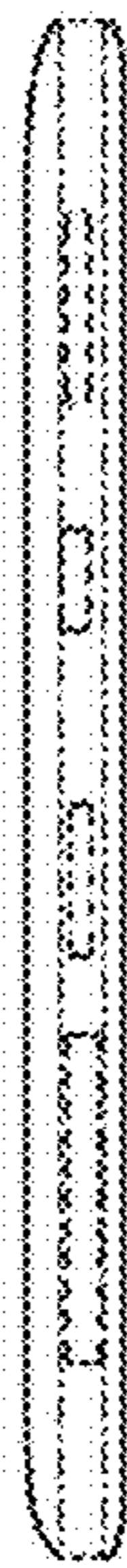

FIG. 11

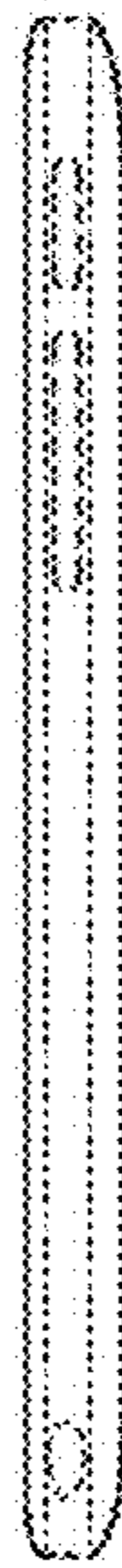

FIG. 12

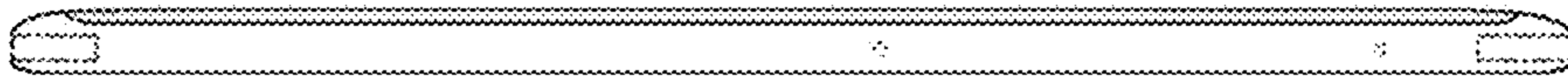

FIG. 13



FIG. 14