



US00D744342S

(12) **United States Design Patent**  
**Blasko et al.**

(10) **Patent No.:** **US D744,342 S**  
(45) **Date of Patent:** **\*\* Dec. 1, 2015**

- (54) **LIQUID COSMETIC CONTAINER**
- (75) Inventors: **Tanya Nicole Blasko**, Baltimore, MD (US); **Ellen Mary Loughren**, Cockeysville, MD (US); **Sandra Ekong**, Baltimore, MD (US); **Graham Clive Hufton**, New York, NY (US)
- (73) Assignee: **The Procter & Gamble Company**, Cincinnati, OH (US)

(\*\*) Term: **14 Years**

(21) Appl. No.: **29/385,294**

(22) Filed: **Feb. 11, 2011**

(51) **LOC (10) Cl.** ..... **09-01**

(52) **U.S. Cl.**  
USPC ..... **D9/516; D9/682**

(58) **Field of Classification Search**  
USPC ..... D9/516, 523, 526, 682, 684, 686-688, D9/690, 692, 694, 448; D6/542; D28/4, D28/76, 99; 215/379, 385, 6; 220/660, 662, 220/665, 669, 675; 222/135, 145.1, 222/145.3-145.6, 320, 321.7-321.9, 222/372-373, 378, 383.1, 384-386, 631  
See application file for complete search history.

(56) **References Cited**

**U.S. PATENT DOCUMENTS**

D236,684	S	*	9/1975	Hebblethwaite	.....	D9/690
D242,773	S	*	12/1976	Licari et al.	.....	D9/448
4,168,128	A		9/1979	Fillmore		
D288,780	S	*	3/1987	Miller	.....	D9/718
4,773,562	A	*	9/1988	Gueret	.....	222/135
4,840,511	A		6/1989	Fattori		
D306,519	S	*	3/1990	Nakata	.....	D3/206
D314,688	S	*	2/1991	Guillerm	.....	D9/448
5,026,193	A		6/1991	Lucas		
D347,385	S	*	5/1994	Kunesh	.....	D9/694
D364,339	S	*	11/1995	Shurtleff	.....	D9/692
D393,593	S	*	4/1998	Mascitelli	.....	D9/448

D393,594	S	*	4/1998	Mascitelli	.....	D9/448
D400,792	S	*	11/1998	Mascitelli	.....	D9/448
D407,974	S	*	4/1999	Zimmer et al.	.....	D9/428
6,053,650	A		4/2000	Bennett		
6,060,547	A		5/2000	Canter		
6,126,352	A		10/2000	Wiley		
7,195,135	B1	*	3/2007	Garcia et al.	.....	222/137
D541,654	S	*	5/2007	Pietrowski	.....	D9/448
D569,724	S	*	5/2008	Bloc et al.	.....	D9/448
D575,166	S		8/2008	Miller et al.		

(Continued)

**FOREIGN PATENT DOCUMENTS**

WO DM/076665 \* 8/2011

**OTHER PUBLICATIONS**

U.S. Appl. 29/385,297, filed Feb. 11, 2011, Tanya Nicole Blasko et al.  
(Continued)

*Primary Examiner* — Dana L Meyrow  
(74) *Attorney, Agent, or Firm* — Betty J. Zea

(57) **CLAIM**  
The ornamental design for a liquid cosmetic container, as shown and described.

**DESCRIPTION**

FIG. 1 is a perspective view of a liquid cosmetic container embodying our new design;  
FIG. 2 is a front elevation view thereof;  
FIG. 3 is a rear elevation view thereof;  
FIG. 4 is a side elevation view thereof;  
FIG. 5 is a top plan view thereof; and,  
FIG. 6 is a bottom plan view thereof.  
The evenly dashed broken lines in the drawings illustrate the portions of the design that form no part of the claim. The dot-dot-dash broken lines in the drawings define the bounds of the claim and form no part thereof.

**1 Claim, 3 Drawing Sheets**

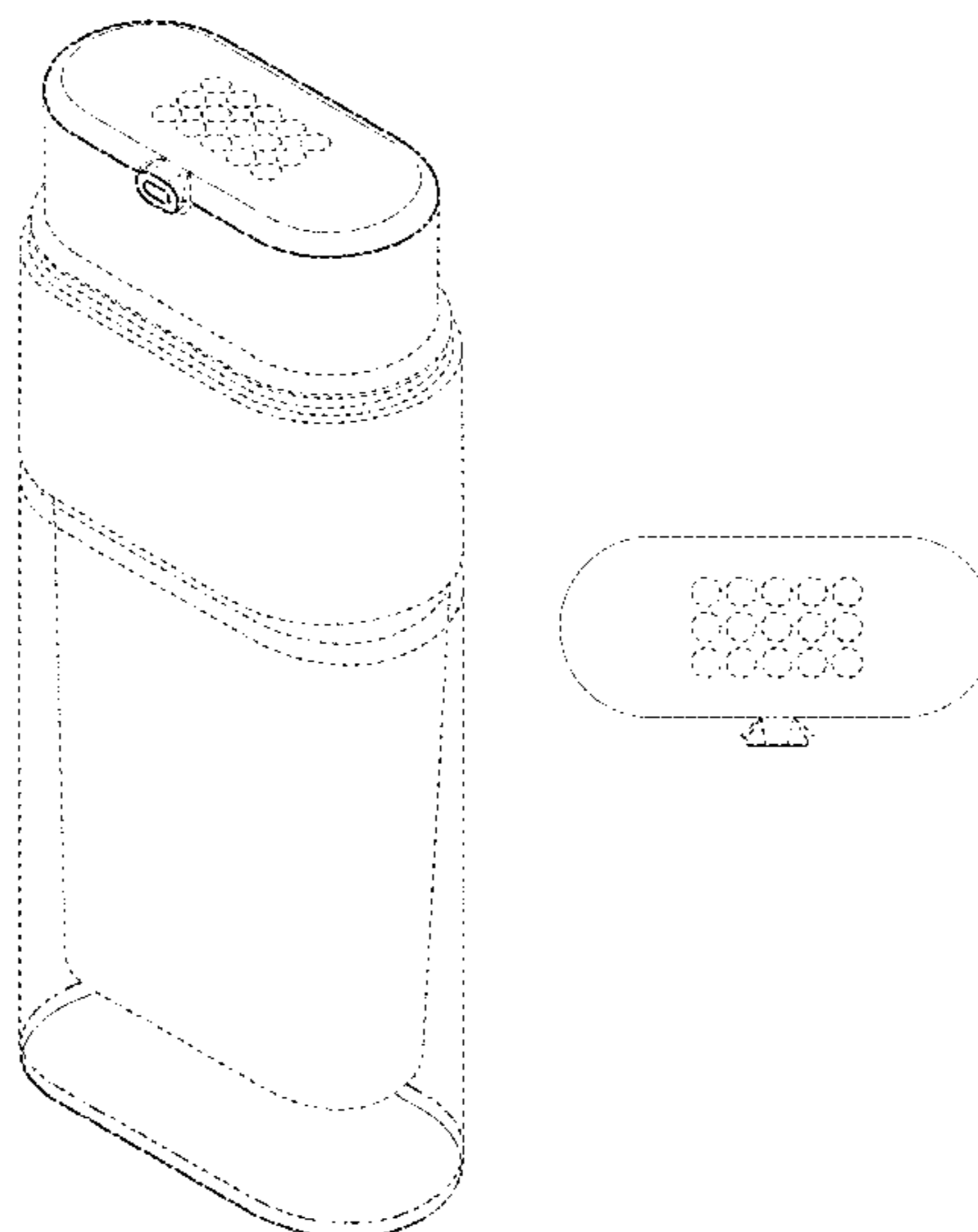

(56)

**References Cited**

U.S. PATENT DOCUMENTS

D601,425 S 10/2009 Miller et al.  
D605,953 S \* 12/2009 Wang Treadway et al. ... D9/689  
D626,852 S 11/2010 Kruetzkamp et al.  
D627,228 S \* 11/2010 Kruetzkamp et al. .... D9/516  
D627,663 S \* 11/2010 Kruetzkamp et al. .... D9/687  
D630,941 S \* 1/2011 Paredes et al. .... D9/430  
D634,211 S \* 3/2011 Kruetzkamp et al. .... D9/687

D634,212 S 3/2011 Kruetzkamp et al.  
D691,049 S 10/2013 Blasko et al.  
2007/0071538 A1 3/2007 Doria

OTHER PUBLICATIONS

U.S. Appl. 29/384,645, filed Feb. 2, 2011, Gina Marie Kruetzkamp, et al.

\* cited by examiner

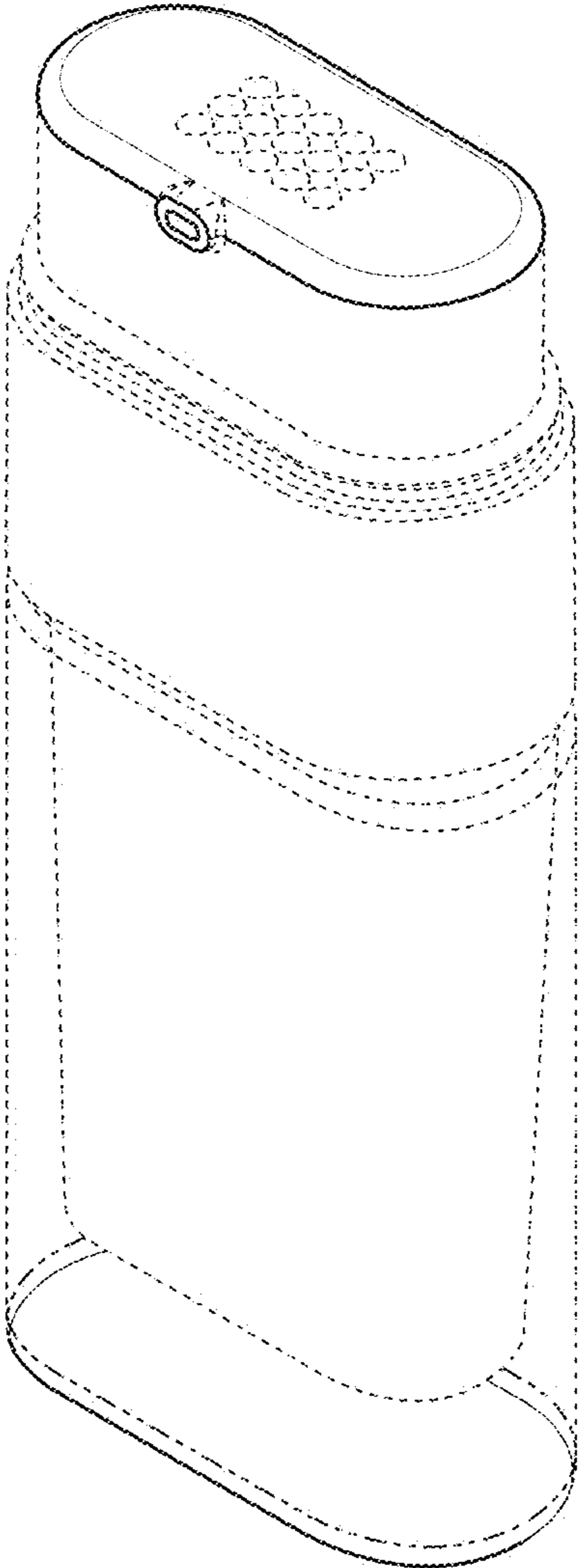

Fig. 1

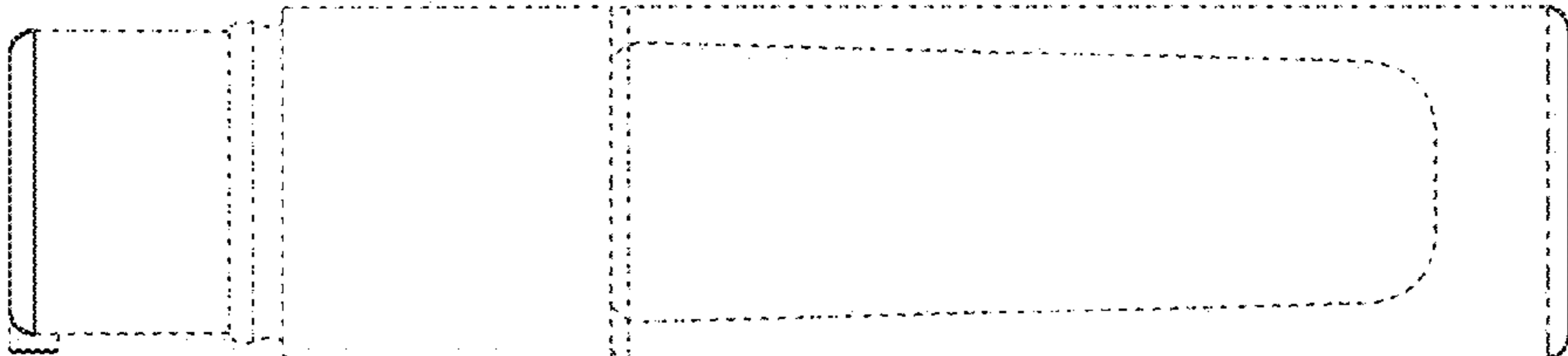

Fig. 2

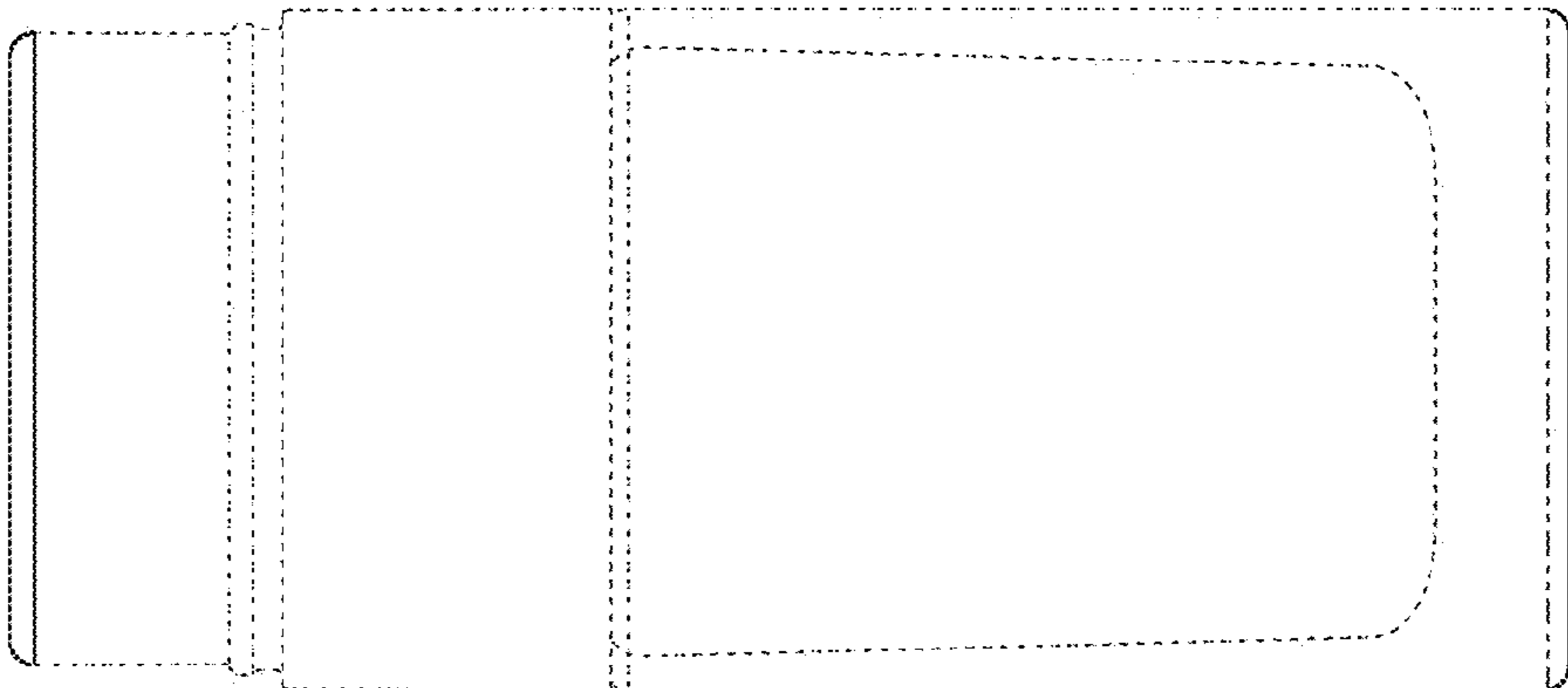

Fig. 3

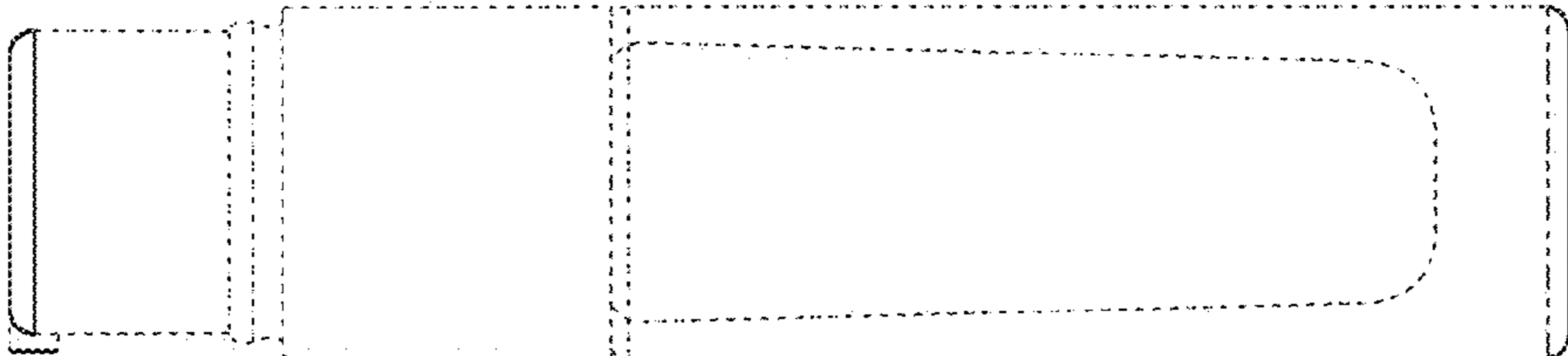

Fig. 4

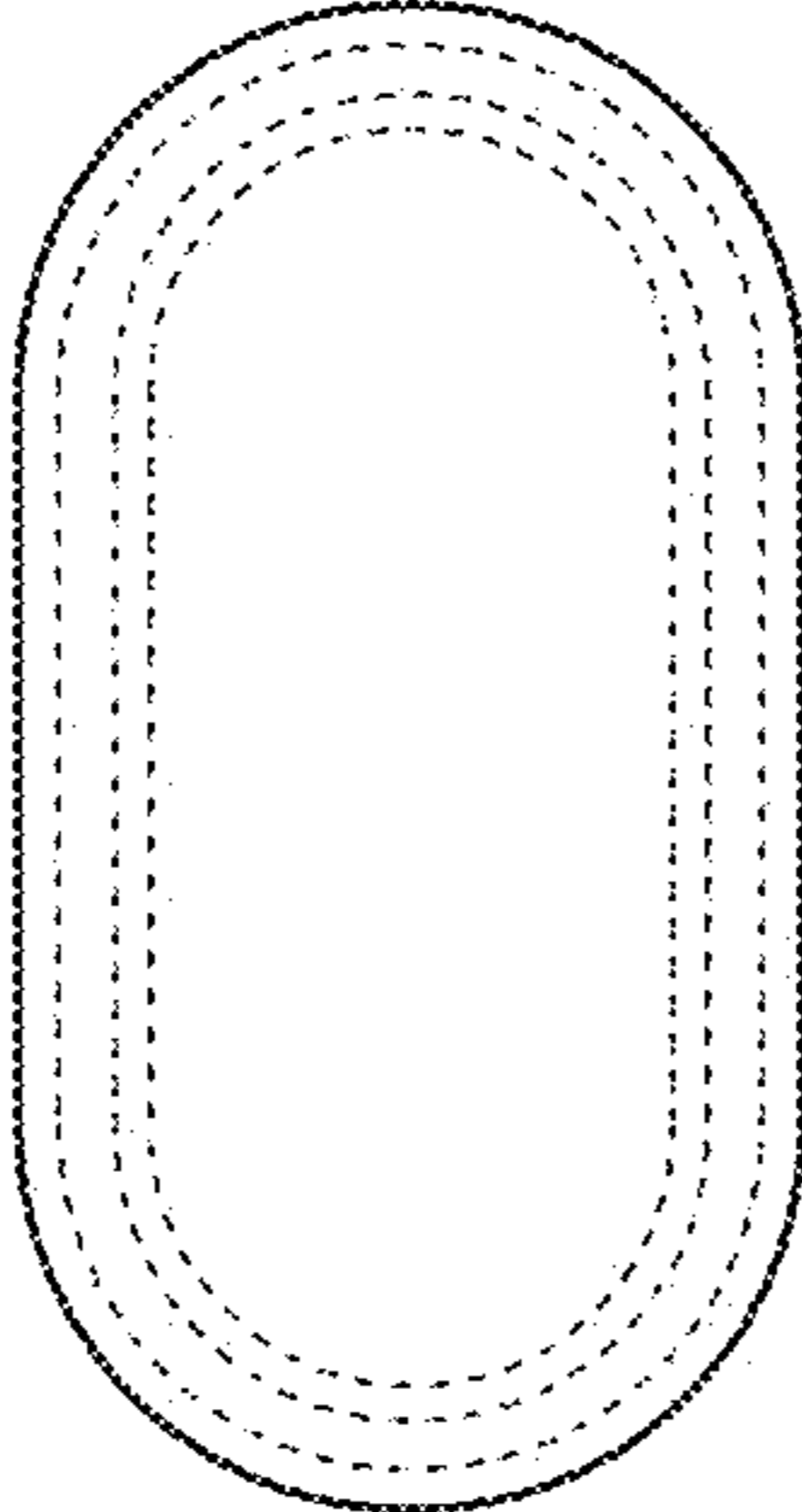

Fig. 6

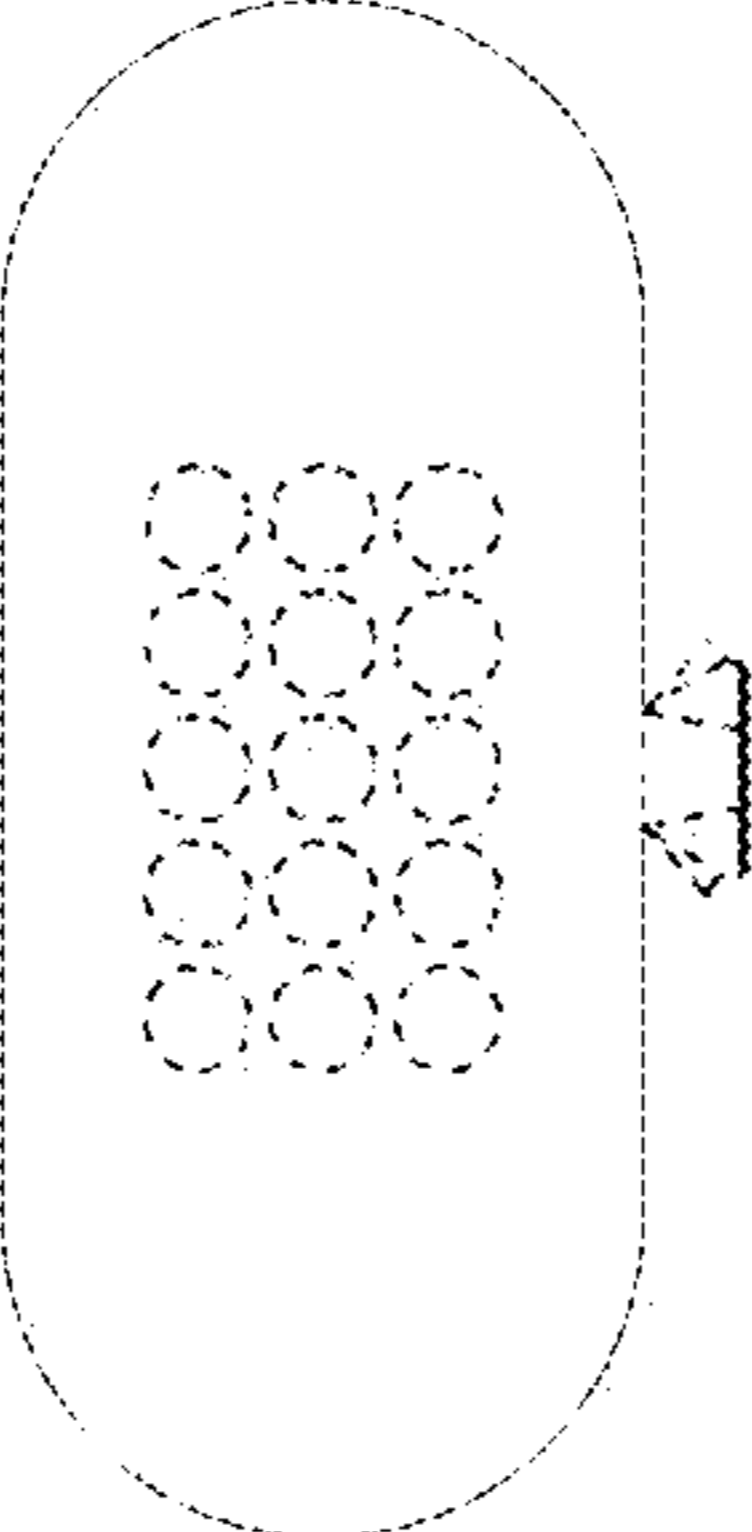

Fig. 5